

Honeywell Pentax 1°/21° Meter

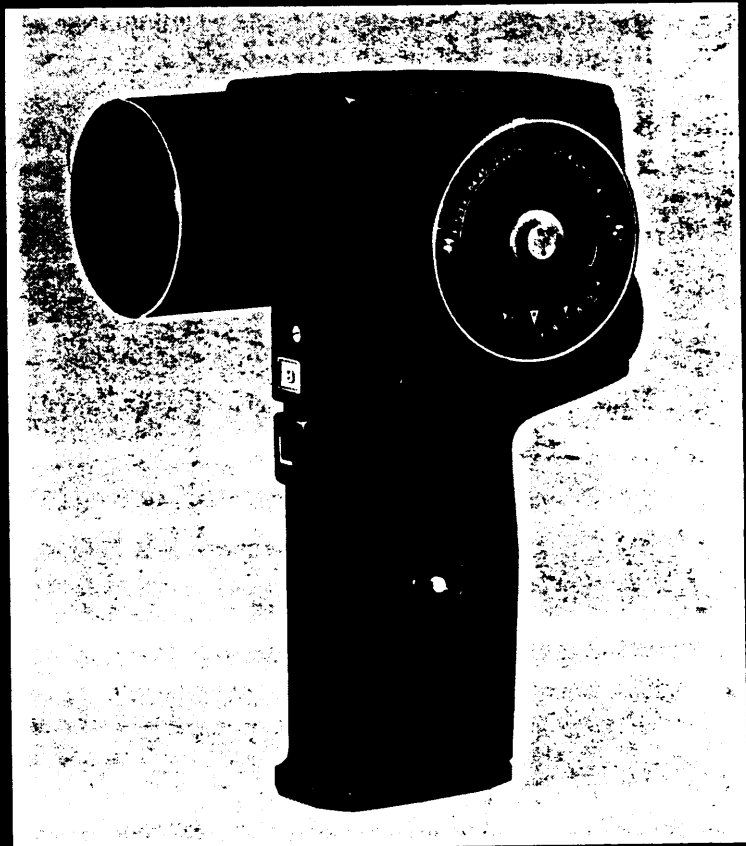

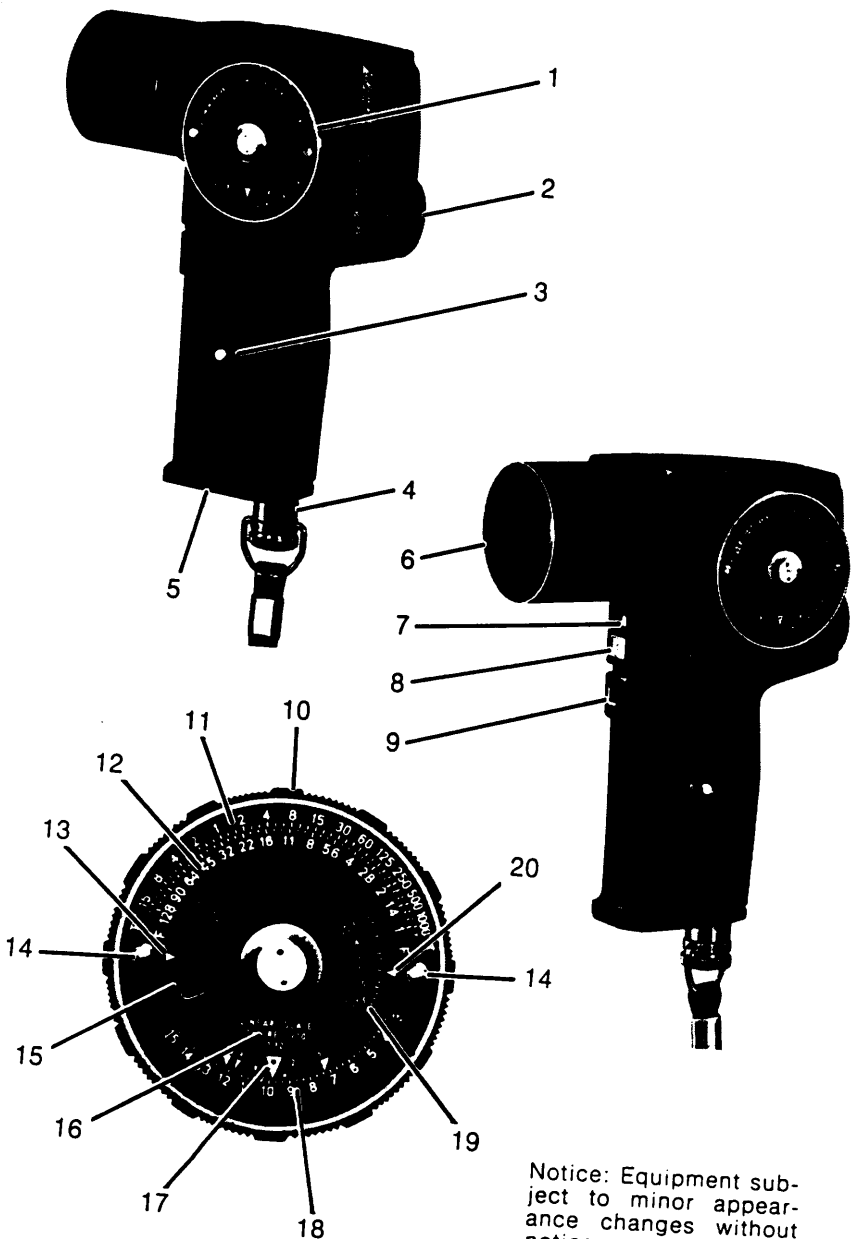

Notice: Equipment sub-
 ject to minor appear-
 ance changes without
 notice.

- | | |
|---|-------------------------------------|
| 1. Calculator | 11. Shutter speed scale |
| 2. Adjustable eyepiece | 12. f/number scale |
| 3. Scale illuminator button | 13. DIN scale index |
| 4. Hand strap retainer | 14. DIN-ASA scale
selection knob |
| 5. Battery housing cover | 15. DIN scale |
| 6. Objective lens | 16. IRE scale |
| 7. Zero adjustment screw | 17. Index for light levels |
| 8. Battery checker button | 18. Light level scale (LL) |
| 9. L switch button for
low light range | 19. ASA scale |
| 10. Knurled outer ring | 20. ASA scale index |

- Type of Measurement** Reflected light meter which reads high light range with the lens cap off and low light range with the "L" button depressed.
- Dimensions** 4.8" deep x 2.4" wide x 6.4" high
127mm deep x 62mm wide x 164mm high
- Weight** 17 oz (475 grams)
- Viewing** Eye level pentaprism viewfinder with adjustable eyepiece
- Viewing Angle** 12° (vertical), 17° (horizontal), 21° (diagonal)
- Light Sensitive Element** Cadmium Sulfide (CdS)
- Metering Angle** 1°
- Light-Level Range** 3 - 18
- Shutter Speed Range** 4 minutes — 1/4000 second
- Diaphragm Range** f/1 - f/128
- Film Speed Range** ASA 6-6400 (DIN 9-39)
- Power Source** One 1.3V mercury battery (Mallory RM640R, Eveready E640N, or equivalent)
One 9V dry battery (Mallory M-1604, Eveready 216, or equivalent)

Operating Instructions

1. Set ASA scale

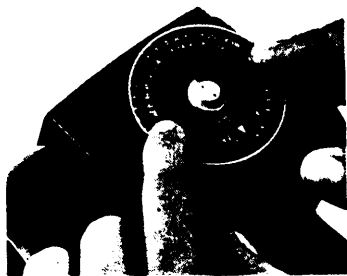

Set the ASA (or DIN) scale to the correct film speed rating of your film.

2. Subject viewing

Point the meter toward the photographic subject and while viewing through the eyepiece (2), center the small circle (center of the scale glass) on the area to be metered. Turn the adjustable eyepiece until you can clearly see the viewfinder scale and the subject.

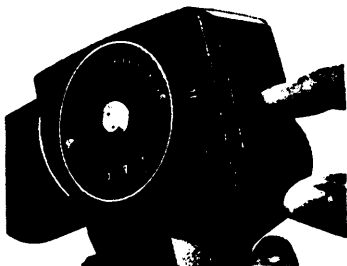

3. Select range

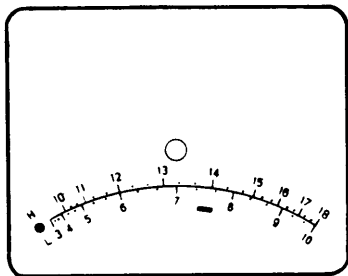

Observe the movement of the needle on the viewing screen. If the subject is sufficiently lighted, the needle will move to the right of the 10 on the H scale. The H (high range) scale covers light levels 10 to 18.

If the needle does not move far enough to the right to reach 10 on the H scale, press the L switch

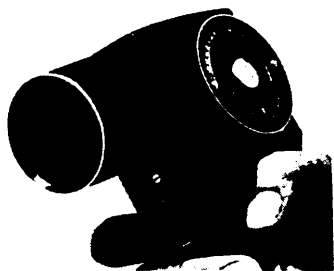

button (9), and observe the light level number selected by the needle on the L scale. The L (low level) scale includes light level numbers 3 to 10.

4. Set index

Determine the light level number from the position of the needle on the scale. Move the knurled outer ring (10) and match the light level number with the light level index (17). The numbers on the light level scale (18) are two colors: white from 3 to 10 (L scale) and orange from 11 to 18 (H scale).

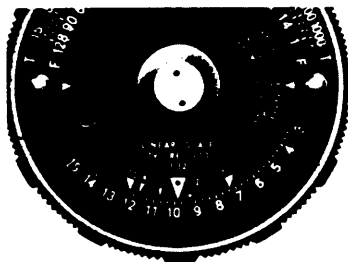

5. Determine exposure

Select the shutter speed and f/stop combination desired from the top scales (11) and (12) on the calculator. Use this data to interpret the scene as described in the enclosed exposure system booklet.

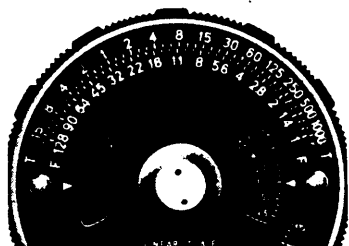

Battery check

The battery checker button (8) checks the life of the 9V dry battery. Look through the eyepiece and depress the battery checker button. If the needle moves to the black mark between figures 7 and 8, the dry battery is still good.

The 1.3 volt mercury battery usually lasts for about a year. When it is not good, the needle will not move rapidly when exposed to bright light.

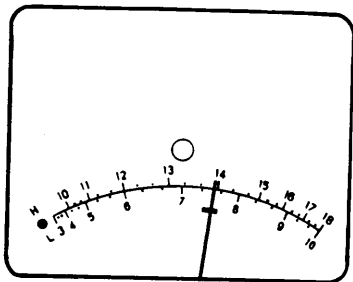

Battery replacement

To replace the 1.3 volt mercury battery, unscrew the battery housing cover (5). Be sure that the new battery is replaced with the positive (+) end toward the cover.

To replace the 9V dry battery, unscrew the strap retainer (4) and turn the lever (A) in the direction of the arrow. The housing will spring open, exposing the dry battery. Be sure that the new battery makes correct contact with the (+) and (-) terminals. When replacement is necessary, use the correct replacement batteries.

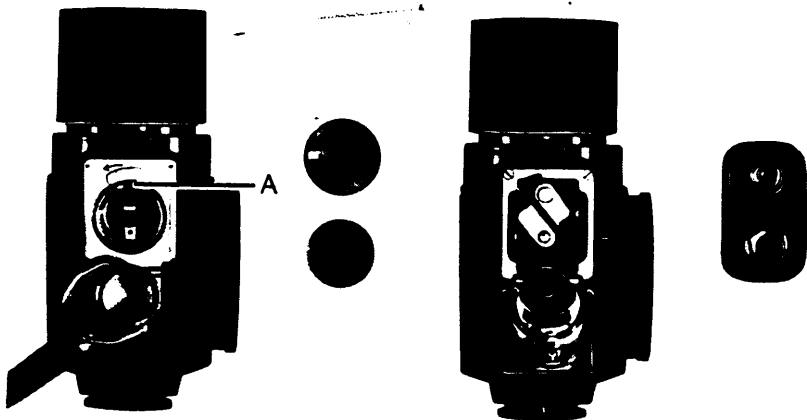

Zero adjust

Observe the position of the needle after removing the 1.3V mercury battery. If the needle is off the zero point, turn the zero adjustment screw (7) with a screwdriver to bring the needle to the zero point. The battery **MUST** be removed to make this adjustment.

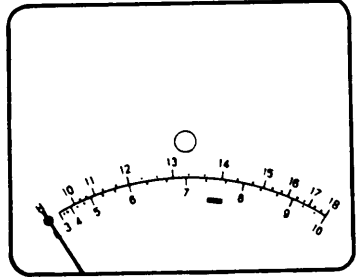

IRE scale

An IRE scale is used for comparison of the energy of light under exposure measurement. The brightest spot in the high-light area is rated at 10 (100% IRE) and other areas are compared with this brightest spot in percentages.

The index 10 (100% IRE) shows the maximum brightness in the high-light detail reproducible on color film. ("White Level".)

The index 1 (10% IRE) shows the maximum darkness in the shadow detail reproducible on color film. The other indices from 2 to 9 (20% - 90% IRE) show the percentage comparison of the brightness based on the "White Level".

The large triangle (green dot) index between the indices 2 and 5 is the standard index calibrated for 18% reflective gray subjects.

The figure "1:32" on the calculator indicates the contrast ratio between IRE scale 1 and 10. The IRE scale from 1 to 10 covers 5 EV ranges; hence the contrast ratio is 1:32.



Colored indices

- Index 8* Yellow
- Index 5* Red
- Standard Index* Green
- Dot between 2 and 3* Blue

**Average index value for each color. Index value is subject to change as color shade changes.*

Cine index

The index for 24 frames per second is the orange triangle on the shutter speed scale (11) between 30 and 60. For 18 frames per second film speed, use the shutter speed 30 (1/30 second). Use the f/stop number facing the orange index for 24 fps or the f/stop number facing 30 for 18 fps.



Conversion table

L.L. values to candle power/foot lamberts

L.L.	nit (cd/m ²)	cd/ft ²	ft-L
3	1.1	0.1	0.3
4	2.2	0.2	0.6
5	4.4	0.4	1.3
6	8.8	0.8	2.5
7	17.5	1.6	5.1
8	35	3.2	10.2
9	70	6.5	20.4
10	140	13.1	40.9
11	280	26.1	81.8
12	560	52.2	163
13	1,120	104	326
14	2,240	208	652
15	4,480	416	1,304
16	8,960	832	2,608
17	17,920	1,664	5,216
18	35,840	3,328	10,432

For neutral colored (gray) subjects/color temperature of 2850K.

Honeywell