

**PENTAX®**

**BINOCULARS  
FERNGLÄSER  
JUMELLES  
BINOCOLI  
PRISMÁTICOS  
VERREKIJKERS**

双筒望远镜  
双眼镜

**OWNER'S MANUAL  
BEDIENUNGSANLEITUNG  
MANUEL D'UTILISATION  
ISTRUZIONI  
MANUAL DE INSTRUCCIONES  
HANDLEIDING**

使用説明書  
使用説明書

**8×21UCF M  
10×21UCF M**

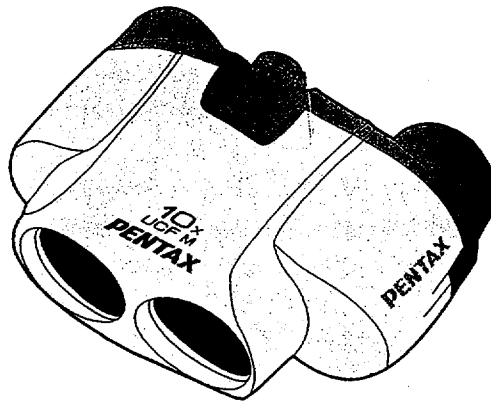

- ⚠ WARNINGS**  
Never attempt to look into the sun with binoculars.
- ⚠ WARNUNG**  
Blicken Sie nie mit einem Fernglas in die Sonne.
- ⚠ ATTENTION**  
N'observez jamais le soleil avec vos jumelles.
- ⚠ AVVERTENZE**  
Non guardate il sole attraverso il binocolo.
- ⚠ ATENCION**  
Nunca intente mirar al sol con prismáticos.
- ⚠ WAARSCHUWINGEN**  
Probeer nooit recht in de zon te kijken met de verrekijker
- ⚠ 警告**  
切勿使用望遠鏡觀望太陽。
- ⚠ 警告**  
双眼鏡で太陽を絶対見ないで下さい。



太陽を見ないでください

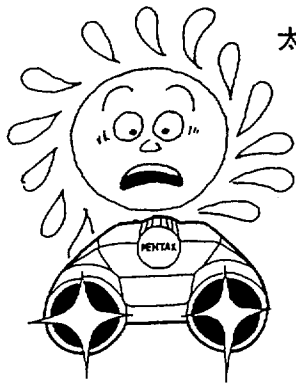

衝撃を与えないでください



高温度にしないでください

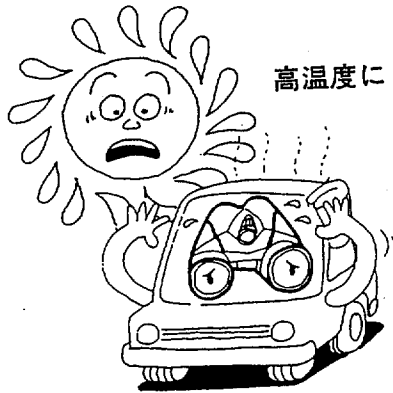

温度差のある場所では  
注意してください

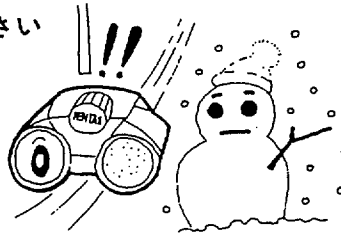
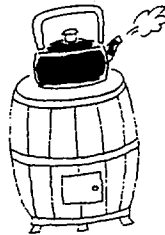

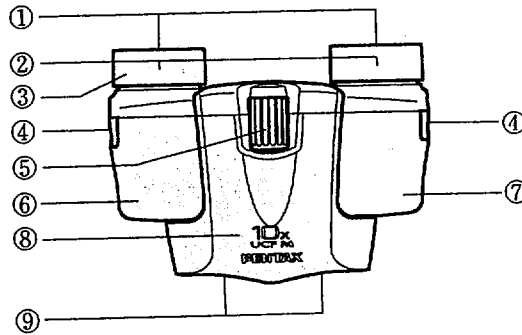

**日本語** 各部名称

- ① 接眼レンズ
- ② 目当てリング
- ③ 視度調整リング
- ④ ストラップ取付部
- ⑤ ピント合わせリング
- ⑥ 右鏡体
- ⑦ 左鏡体
- ⑧ 中央ボディ
- ⑨ 対物レンズ

**Italiano** Componenti e comandi

- ① Lenti dell'oculare
- ② Anello oculare
- ③ Anello di regolazione diottrica
- ④ Attacco per tracolla
- ⑤ Ghiera di messa a fuoco centrale
- ⑥ Barilotto destro
- ⑦ Barilotto sinistro
- ⑧ Montatura monoblocco
- ⑨ Lenti dell'obiettivo

**English** Names of Parts

- ① Eyepiece Lenses
- ② Eyepiece Ring
- ③ Diopter Adjusting Ring
- ④ Strap Hooks
- ⑤ Central Focusing Wheel
- ⑥ Right Barrel
- ⑦ Left Barrel
- ⑧ Uni-Barrel
- ⑨ Objective lenses

**Español** Nombres de los componentes

- ① Lente del ocular
- ② Anillos de los oculares
- ③ Anillo de ajuste de la dioptría
- ④ Enganches de la correa de sujeción
- ⑤ Rueda central de enfoque
- ⑥ Barrilete derecho
- ⑦ Barrilete izquierdo
- ⑧ Cuerpo monobloque
- ⑨ Lente del objetivo

**Deutsch** Bezeichnung der Teile

- ① Okularlinsen
- ② Augenmuscheln
- ③ Dioptrien-Einstellknopf
- ④ Riemenöse
- ⑤ Mitteltrieb-Scharfeinstellrad
- ⑥ Rechtes Fernglasrohr
- ⑦ Linkes Fernglasrohr
- ⑧ Einheitsfassung
- ⑨ Objektivlinse

**Nederlands** De verschillende onderdelen

- ① Oculairlenzen
- ② Oculairring
- ③ Dioptriering
- ④ Haak
- ⑤ Centraal scherpestelwiel
- ⑥ Rechter cilinder
- ⑦ Linker cilinder
- ⑧ één cilinder
- ⑨ Objectieflenzen

**Français** Descriptif

- ① Lentille de l'oculaire
- ② Bague de l'oculaire
- ③ Bague de réglage dioptrique
- ④ Crochet de fixation
- ⑤ Molette de mise au point centrale
- ⑥ Corps droit
- ⑦ Corps gauche
- ⑧ Corps monobloc
- ⑨ Lentille de l'objectif

**中國語** 部件名稱

- ① 接目鏡
- ② 接目鏡環
- ③ 視差調校環
- ④ 肩帶扣
- ⑤ 中央對焦環
- ⑥ 右鏡筒
- ⑦ 左鏡筒
- ⑧ 連體鏡身
- ⑨ 物鏡

## English

### Features

Pentax 21-Series UCF M (Uni-Barrel Center Focusing) binoculars are high-performance binoculars rooted in advanced optical technology and plentiful experience.

The optics incorporate glass prisms with a high refractive index and aspherical lenses for sharp images even in the corners of the field of vision.

These easy-to-carry binoculars are thinner than the popular Pentax 21 Series and offer a superb combination of compactness and operability. They are equipped with a newly designed sliding type eyepiece ring and diopter adjusting ring with center click.

### ⚠ WARNINGS

1. To avoid serious eye damage, NEVER look at the sun using the binoculars. Serious damage to the retina, or total loss of eyesight may occur.
2. Do not leave the binoculars in direct sunlight. Sun rays passing through the binoculars will be intensified, and should they focus on flammable materials, fire may occur.

### ⚠ Safety Precautions

1. Do not use the binoculars while walking as depth perception and peripheral vision are dramatically altered.
2. Caution should be taken when adjusting the binocular barrels to avoid fingers being pinched.
3. Using the binoculars continuously for a long time may cause inflammation of the skin around the eye where the eyepiece ring come in contact with the skin. Consult a physician if any symptoms are noticed.
4. Do not swing the binoculars by the neck strap.
5. Be careful with the vinyl bag. Keep the vinyl bag in which the binoculars are packed for delivery, and all other vinyl bags, out of the reach of children and infants, as there is a risk of suffocation.

### Handling Precautions

1. Do not apply excessive force when adjusting the focusing wheel, diopter adjusting ring or eyepiece width.
2. Do not drop the binoculars or subject them to strong vibration, impact or pressure.
3. Never expose the binoculars to high temperature (Over 60 degrees centigrade or 140 degrees Fahrenheit). Avoid leaving the binoculars for an extended period of time in a hot humid place such as in a car parked in the sun or near a heater, as this could cause the binoculars to become deformed.
4. Care should be taken when the binoculars are taken between two places with widely varying temperatures difference as condensation or, in extreme cases, icelets may form that could cause rust or other damage. In such circumstances the binoculars should be covered so that the temperature change will be as gradual as possible. After the temperatures have stabilized, the binoculars may be uncovered and used again.
5. Reasonable care should be taken to prevent exposure to dirt, mud, sand, moisture, toxic gas, water, salt water, or any other substance which may penetrate the inside of the binoculars, or the mechanisms. These substances may cause internal damage or render the binoculars inoperable.
6. Keep in mind that the binoculars are not water or weather resistant. If water splashes onto the binoculars, allow them to dry naturally, then wipe away any residual dirt with a clean, soft, dry cloth.
7. Binoculars should be stored in a well-ventilated place to prevent fungus growth. Never store them in a closet with mothballs or in an environment where chemicals are handled.

## English

### How to Use

#### 1. Eyepiece Rings

For easy viewing, the binoculars are usually operated with the eyepiece rings pulled out. (See 1)

When wearing glasses, push back the eyepiece ring to the original position.

When pulling out the eyepiece ring, do not pull too strong. Do not attempt to rotate it.

#### 2. Adjusting the Eyepiece Width

While looking at a distant object through both the right and left eyepiece lenses, adjust the barrels so that eyepieces are comfortably in front of your eyes. (See 2)

#### 3. Adjusting the diopter control.

While looking at a distant object through the left eyepiece lens with your left eye, and your right eye closed, turn the central focusing wheel until the object appears sharp. (See 3-1)

Next, while looking at the same object through the right eyepiece lens with your right eye, and your left eye closed, turn the diopter adjusting ring until the object appears sharp. (See 3-2)

Once proper focusing has been set, object at different distances can be viewed by turning only the central focusing wheel.

#### 4. How to Attach the Strap

To attach the strap to the binoculars, pass the Strap Ring through the Strap Hook, and then pass the end of the Strap through the Strap Ring and then gently pull the Strap until it is tight. (See 4)

Strap Hooks are positioned on either side of the binoculars so that you can position the Strap on the side that is most convenient for you.

- ⑩ Strap Hook
- ⑪ Strap Ring
- ⑫ Strap

1

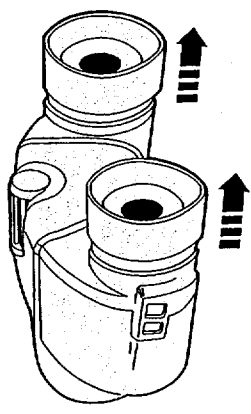

2

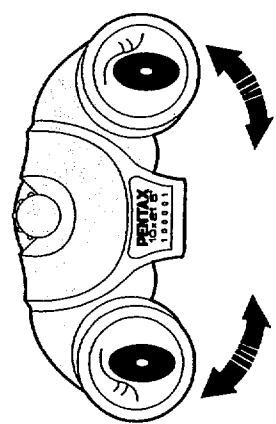

3-1

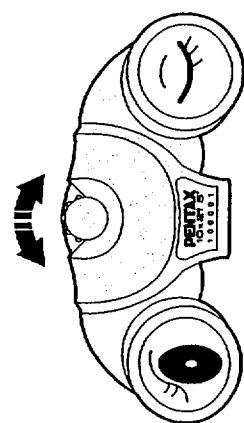

4

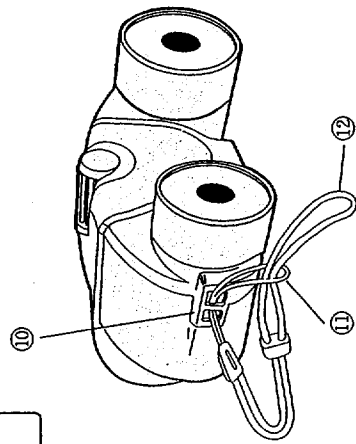

3-2

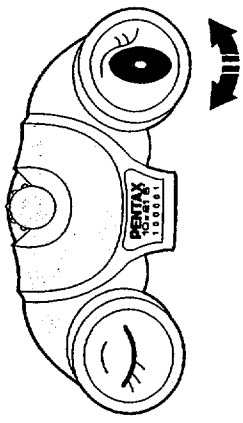

**English****Specifications**

Features \ Models	8×21UCF M	10×21UCF M
Type	Porro prism, center focusing (Linked-dual-axis)	
Magnification	8X	10X
Effective diameter of objective lens	21mm	
Real field of view	6.2°	5.0°
Field of view at 1000m Field of view at 1000yards	108m 324ft.	87m 261ft.
Exit pupil aperture	2.6mm	2.1mm
Relative brightness	6.7	4.4
Eye relief	13mm	9.5mm
Focusing range	About 2.8m to infinity About 9.2ft to infinity	
Eye width (ocular distance) Adjustable range	57.5mm to 72.5mm 2.3 in to 2.9 in	
Height & width	81mm×107mm 3.2 in×4.2 in	78mm×107mm 3.1 in×4.2 in
Thickness	46.5mm (1.8 in)	
Weight	195g (6.9 oz)	
Accessories	Eyepiece lens cap, case, strap	

**Français****Caractéristiques**

Modèles \ Caractéristiques	8×21 UCF M	10×21 UCF M
Type	Prisme de Porro, mise au point centrale (couplage des deux axes)	
Grossissement	8X	10X
Diamètre effectif de l'objectif	21mm	
Champ visuel réel	6,2°	5,0°
Champ visuel à 1000m	108m	87m
Ouverture de la pupille de sortie	2,6mm	2,1mm
Luminosité relative	6,7	4,4
Dégagement oculaire	13mm	9,5mm
Plage de mise au point	de 2,8m environ à l'infini	
Plage de réglage de l'écart interpupillaire	57,5mm à 72,5mm	
Hauteur et largeur(mm)	81mm×107mm	78mm×107mm
Epaisseur	46,5mm	
Poids	195g	
Accessoires	Bouchons d'oculaire, étui, courroie	



## 旭光学工業株式会社

〒174-8639 東京都板橋区前野町2-36-9

## ペンタックス販売株式会社

〒100-0014 東京都千代田区家田町1-11-1

### ●お問い合わせは次の各サービス窓口へ

- ペンタックスフォーラム 〒163-0401 東京都新宿区西新宿2-1-1 新宿三井ビル1階(私書箱240号)  
☎03(3348)2941(代)
- 旭光学 東京 サービスセンター 〒104-0061 東京都中央区銀座西8-10 (土橋交差点交番並び)  
☎03(3571)5621(代)
- 〃 札幌 サービスセンター 〒060-0010 札幌市中央区北10条西18-36 ペンタックス札幌ビル4階  
☎011(812)3231(代)
- 〃 仙台 サービスセンター 〒981-3133 仙台市泉区泉中央1-7-1 千代田生命泉中央駅ビル5階  
☎022(371)6663(代)
- 〃 新潟 サービスセンター 〒951-8067 新潟市本町通7番町1153 新潟本町通ビル4階  
☎025(224)8391(代)
- 〃 横浜 サービスセンター 〒231-0047 横浜市中区羽衣町2-7-10 日本生命関内ビル8階  
☎045(232)5281(代)
- 〃 静岡 サービスセンター 〒420-0858 静岡市伝馬町24-2 住友建設ビル5階  
☎054(255)6308(代)
- 〃 名古屋 サービスセンター 〒461-0001 名古屋市長区泉1-19-8  
☎052(962)5331(代)
- 〃 大阪 サービスセンター 〒542-0081 大阪市中央区南船場1-17-9 パールビル2階  
☎06(6271)7996(代)
- 〃 広島 サービスセンター 〒733-0035 広島市西区南観音3-5-2 空港通りビル6階  
☎082(234)6881(代)
- 〃 福岡 サービスセンター 〒810-0802 福岡市博多区中洲中島町3-8 パールビル1階  
☎092(281)6868(代)
- 〃 お客様相談室 〒104-0061 東京都中央区銀座西8-10 (土橋交差点交番並び)  
☎03(3572)6479

※日曜・祝日および土曜日は原則として休みます。  
ただし、年末年始を除きペンタックスフォーラムは年中無休です。

### ●アフターサービスについて

本製品の、補修用性能部品は、製造打ち切り後5年間を目安として保有しております。従って本期間中は原則として修理をお受け致します。なお、期間以後であっても修理可能な場合もありますので、当社サービス窓口にお問い合わせください。

## PENTAX

Asahi Optical Co., Ltd. 11-1, Nagata-cho 1-chome, Chiyoda-ku, Tokyo 100-0014, JAPAN  
(Internet://www.pentax.co.jp/)

Pentax Europe n.v. Weveldlaan 3-5, 1930 Zaventem, BELGIUM  
(Internet://www.pentaxeuropa.com/)

Pentax GmbH. Julius-Vosseler-Strasse, 104, D-22527 Hamburg, GERMANY  
(Internet://www.pentax.de/)

Pentax U.K. Limited Pentax House, Heron Drive, Langley, Slough Berks SL3 8PN, U.K.

Pentax France S.A. 12/14, rue Jean Poulmarch, 95100 Argenteuil Cedex, FRANCE

Pentax Benelux B.V. (for Netherlands) Spinveld 25, 4815 HR Breda, NETHERLANDS

(for Belgium & Luxembourg) Weveldlaan 3-5, 1930 Zaventem, BELGIUM

Pentax (Schweiz) AG Industriestrasse 2, 8305 Dietlikon, SWITZERLAND

Pentax Scandinavia AB P.O. Box 650, 75127 Uppsala, SWEDEN

Pentax Corporation 35 Inverness Drive East, Englewood, Colorado 80112, U.S.A.

(Internet://www.pentax.com/)

Pentax Canada Inc. 3131 Universal Drive, Mississauga, Ontario L4X 2E5, CANADA

- ☆ SPECIFICATIONS ARE SUBJECT TO CHANGE AT ANY TIME WITHOUT NOTIFICATION OR ANY OBLIGATION ON THE PART OF THE MANUFACTURER.
- ☆ DIE TECHNISCHEN DATEN DES PRODUKTES KÖNNEN JEDERZEIT OHNE WEITERE VERPFLICHTUNGEN SEITENS DES HERSTELLERS GEÄNDERT WERDEN.
- ☆ LES CARACTERISTIQUES DE CET APPAREIL SONT SUJETTES A MODIFICATIONS SANS AUCUN ENGAGEMENT DE LA PART DU FABRICANT.
- ☆ LE CARATTERISTICHE POSSONO ESSERE SOGGETTE IN QUALSIASI MOMENTO A VARIAZIONI SENZA ALCUN PREAVVISO O OBBLIGO DA PARTE DEL FABBRICANTE.
- ☆ LA FICHA TECNICA ES SUSCEPTIBLE DE MODIFICACION EN CUALQUIER MOMENTO SIN NOTIFICACION NI OBLIGACION ALGUNA POR PARTE DEL FABRICANTE.
- ☆ SPECIFICATIES KUNNEN TE ALLEN TIJDE WORDEN GEWIJZIGD ZONDER VOORAFGAANDE KENNISGEVING OF ENIGE VERPLICHTING VAN DE KANT VAN DE FABRIKANT.

☆ 上述部份規格如有更改，請恕廠方不另行通知。

☆ 記載内容の仕様などの一部が予告なく変更される場合があります。

02-9911