

PENTAX®

645N

OPERATING MANUAL



FOR SAFE USE OF YOUR CAMERA

Although we have carefully designed this camera for safe operation, please be sure to follow precautions given on this page.

⚠ WARNING This mark indicates precautions that, if not followed, could result in serious injury to the operator.

⚠ CAUTION This mark indicates precautions that, if not followed, could result in minor or medium injury to the operator or damage to the equipment.

⚠ WARNING

- Wrapping the strap around your neck is dangerous. Make sure that small children do not get the strap caught around their neck.
- Do not look directly at the sun through the camera, as viewing the sun for an extended period may damage your eyes.

⚠ CAUTION

- Never try to disassemble, short or recharge the battery. Also, do not dispose of the battery in fire, as it may explode.
- Remove the batteries from the camera immediately if they become hot or begin to smoke. Be careful not to burn yourself during removal.

Welcome to the Fantastic World of Pentax Autofocus Multi-Mode Medium Format Photography

The Pentax 645_N, our latest development in the area of the medium format SLR, promises a superior 6 x 4.5cm result with 120, 220, or 70mm film.

Made possible through our vast experience and technology accumulated over the years, the new autofocus multi-mode 645_N assures pin-sharp focus accuracy with AF Spot and AF Wide selection, and the 6-segment multi-pattern metering allows precise exposure control under widely varying conditions. Unsurpassed versatility is assured through the utilizing of a full range of exposure modes (Programmed AE, Aperture-Priority AE and Shutter-Priority AE, Metered Manual and TTL auto flash control), as well as an exposure compensation control and Auto-Bracketing Mode.

With a 645 A- or FA lens attached, the 645_N imprints relevant information (frame number, shutter speed, aperture setting, exposure control and auto-bracketing mode.

The Pentax 645_N is a professional camera possessing a number of highly sophisticated features: built-in automated film wind, an external LCD information panel and clearly visible LCD information in the viewfinder.

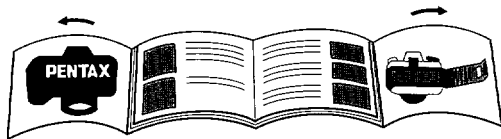

Lenses and accessories produced by other manufacturers are not made to our precise specifications and therefore may cause difficulties with or actual damage to your Pentax camera. We do not assume any responsibility or liability for difficulties resulting from the use of lenses and accessories made by other manufacturers.

NAMES OF WORKING PARTS I

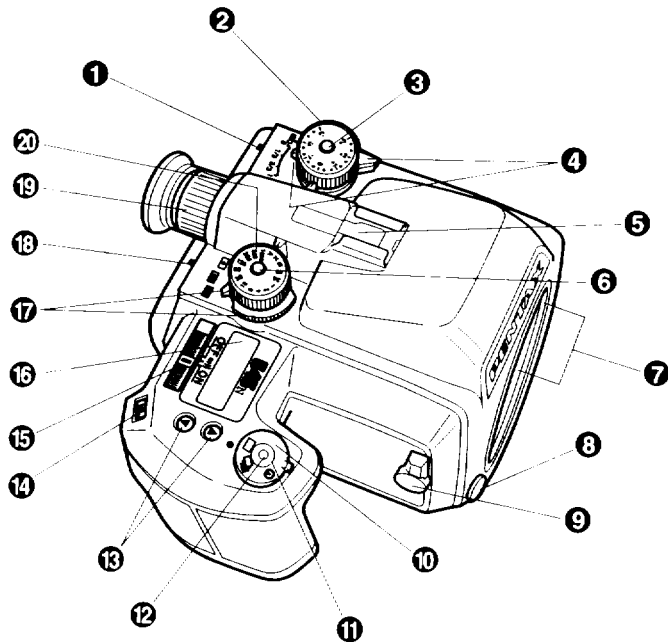

- ❶ AF mode selector (p.29,53)
- ❷ Exposure compensation dial (p.48)
- ❸ Exposure compensation dial release button (p.48)
- ❹ Auto bracketing selector (p.49)
- ❺ Hotshoe (p.62)
- ❻ Shutter speed dial release button
- ❼ Lens information contacts
- ❽ Lens unlock button (p.12)
- ❾ Preview lever (p.68)
- ❿ Drive mode selector (p.30,34,35)
- ⓫ Shutter release button (p.16)
- ⓬ Release socket (p.47)
- ⓭ Up / down buttons
- ⓮ Memory lock button (p.52)
- ⓯ Main switch (p.10)
- ⓰ LCD panel (p.3)
- ⓱ Metering mode selector (p.27,50, 51)
- ⓲ AF frame selector (p.30,54)
- ⓳ Diopter adjustment ring (p.24)
- ⓴ Shutter speed dial

PRECAUTIONS FOR YOUR CAMERA

Your Pentax camera is a high-precision mechanism. Handle it with great care.

Precautions when taking pictures

- Do not use the camera where it may come in contact with rain, water, or any other liquid, because the camera is not weather, water, or liquid resistant. Should the camera get wet from rain, splashing water, or any other liquid wipe it off immediately with a dry soft cloth.
- Do not drop the camera or allow it to hit solid objects. If the camera suffers a shock or impact, take it to a Pentax service center for inspection.
- Be careful not to subject the camera to strong vibrations, shock or pressure. Use a cushion to protect the camera when carrying it in a motorcycle, car, boat, etc.
- Condensation on the interior or exterior of the camera may be extremely harmful to the camera mechanism as it may cause rust. Furthermore, if the camera is taken from warm temperature to a subfreezing one or vice versa, the formation of icelets may cause damage. In such a case, put the camera into a case or plastic bag so that any changes in temperature difference is minimized. Do not remove it from the bag until temperature has stabilized.

- Regular size color prints may cut off what appears on the extreme edges of the film frame. Compose your picture with a margin of safety at the edges.

Precautions for storage

- Avoid leaving the camera for extended periods in places where the humidity and temperature are very high, such as in a car.
- Do not store the camera in a closet with moth balls or in an area where chemicals are handled. Store it in a place with good dry air circulation to prevent the growth of fungus.

Precautions for proper care

- Never touch the shutter curtain or mirror with your finger or any other object.
- Use a blower and lens brush to remove dust accumulated on the lens or viewfinder.
- Never use solvents such as paint thinner, alcohol or benzene to clean the camera.
- Electrical problems may often be caused by water, dirt or dust at points of electrical contact. Also check for battery leakage, traces of dirt or grease, or corrosion due to salinity or gas. If you cannot correct the problems, have your camera inspected at a Pentax service center. Repairs of this nature are not covered under the terms of the warranty and charges may be assessed.

Other precautions

- The temperature range at which this camera functions properly is 50°C to -10°C (122°F to 14°F).
- A camera which has been submerged in water usually cannot be repaired. If such an accident should occur, it is advisable to contact a Pentax Service Center immediately.
- To maintain optimum performance, it is recommended that the camera be inspected every one or two years. If the camera has not been used for an extended period, or is being prepared for an important photographic session, it is recommended that you have the camera inspected or test shoot with it.
- Repairs deemed necessary due to usage of this product in an industrial or commercial application may not be covered under the terms of the Pentax warranty.
- The PENTAX warranty provides only for the repair of defects in materials or workmanship. Damage of any kind cannot be repaired at no charge under the terms of the warranty. If the difficulty is caused as a direct result of the product being used in conditions as outlined in the "Precautions for Your Camera" section or any other operation contrary to the instructions outlined in this manual, charges will be assessed and a repair quotation will be provided.

PRECAUTIONS FOR BATTERY USAGE

- Use six 1.5V AA size alkaline, or lithium batteries.
- Misuse of the battery can cause hazards such as leakage, overheating, explosion, etc. The battery should be inserted with the "+" and "-" sides facing correctly.
- Battery performance may be temporarily hindered in low temperatures, but will recover in normal temperatures.
- Keep a spare battery on hand for replacement convenience when shooting outdoors or while traveling.
- Replace the batteries at the same time. Do not mix battery brands, type or an old battery with a new one. As this may cause explosion or overheating.

LCD PANEL INDICATION

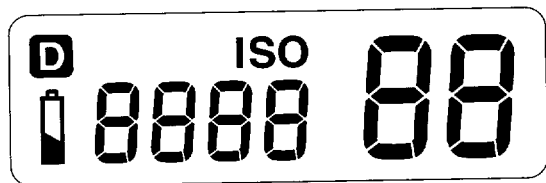

- 88 : Frame Counter (p.22)
- 8888: Film Speed Information (p.20)
- ISO : Film Status Information (p.20)
- 🔋 : Battery Exhaustion Warning (p.11)
- D : Imprinting Exposure Data Information (p.60)

LCD (Liquid-Crystal Display)

When the LCD is exposed to high temperatures over approximately 60°C it may blacken, but when the temperature normalizes, it should return to normal.

VIEWFINDER INDICATION

3

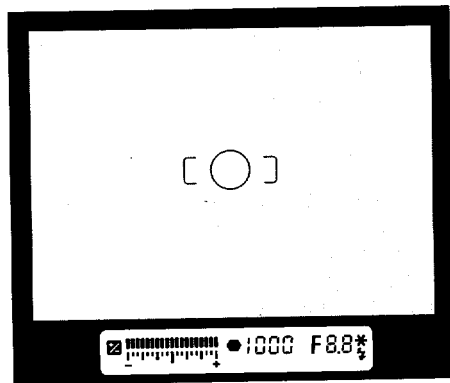

- [] : 3-point AF Frame (p.30)
- 1/300 : Shutter Speed (p.38, 41, 43, 45)
- F8.8 : Aperture Value (p.38, 41, 43, 45)
- ⚡ : Flash Status Information (p.62)
- : In-Focus Indicator (p.32)
- ☒ : Exposure Compensation (p.48)
- ▬ : Bar Graph (p.45, 48)
- : Spot Metering / Focusing Area (p.51, 54)

TABLE OF CONTENTS







Names of working parts	Flaps	
Safe use of your camera	Inside cover	
Precautions for your camera		1
Precautions for battery usage		2
LCD panel indication		3
Viewfinder indication		3
I. BASIC OPERATION (PREPARATION)		7 - 24
Attaching the camera strap		7
Loading the batteries		8
Turning on the power		10
• When the batteries are exhausted		11
Attaching the lens		12
Attaching/Detaching the film holder 120 and 220		14
Depressing the shutter release button		16
Film loading		17
	Setting the film speed (ISO)	20
	Unloading the film	21
	Unloading the film in mid-roll	22
	Installing the eyecup	23
	Adjusting the viewfinder diopter	24
II. BASIC OPERATION (SHOOTING)		26 - 33
	Using the Programmed AE Mode	26
	Using the Multi(6)- segment metering mode	27
	Selecting the autofocus mode	28
	Using the Single AF Mode	29
	Using the 3-point AF mode	30
	Using the Single-Frame Drive Mode	30
	Holding the camera	31
	Taking a picture	32

III. ADVANCED OPERATION	34 - 72
Selecting a Drive Mode.....	34
• Consecutive - Frame Mode.....	34
• Self-Timer Mode.....	35
Taking multi-exposure pictures.....	36
Selecting an Exposure Mode.....	38
• Using the Programmed AE Mode.....	38
• Using the Aperture-Priority AE Mode.....	40
• Using the Shutter-Priority AE Mode.....	42
• Using the Metered Manual Mode.....	44
• Using the Bulb Exposure Mode.....	46
About Exposure Compensation.....	48
Using the Auto Bracketing Mode.....	49
Switching the Metering Mode.....	50
• Center-weighted Metering Mode.....	50
• Spot Metering Mode.....	51
Using the Memory Lock.....	52
Setting the autofocus mode in the Servo position.....	53

Using the Spot AF Mode.....	54
Focus Lock Function.....	55
Manual focusing.....	56
Imprinting the exposure data on the film.....	60
Using a Pentax Dedicated External Flash.....	62
Daylight-sync shooting.....	66
Slow-speed-sync shooting.....	67
About the preview lever.....	68
Accessories (Optional).....	69
• Interchangeable focusing screens.....	70
The infrared index.....	72
IV. OTHERS	73 - 79
Troubleshooting.....	74
Specifications.....	76
Warranty policy.....	78

I. BASIC OPERATION (PREPARATION)

Icon indicators used in this manual

Operation direction	
Automatic operation	
Attention	
Lamp blinking	
Correct	
Incorrect	

ATTACHING THE CAMERA STRAP

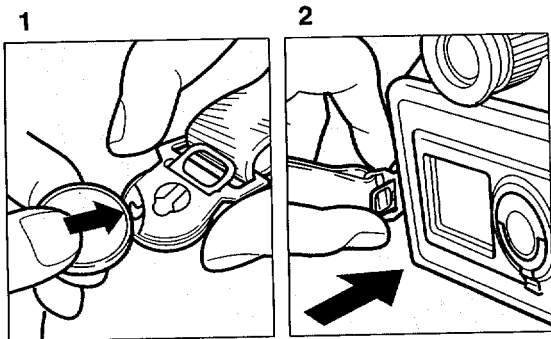

1. Slide the illustrated part of the clasp in the direction of arrow by using a coin or similar object.
 2. Put the clasp onto the strap lug with its black surface side facing out, and return the lock plate to the original position. It will securely attach to the strap lug.
- Adjust the length of the strap with the buckle.
 - To remove the strap, slide the lock plate with a coin or similar object (as in step 2, above).
 - After fitting the strap and adjusting the length, pull the strap hard to confirm if the strap has securely attached to the camera.

LOADING THE BATTERIES

BASIC OPERATION (PREPARATION)

1

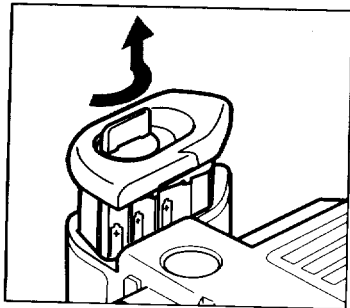

2

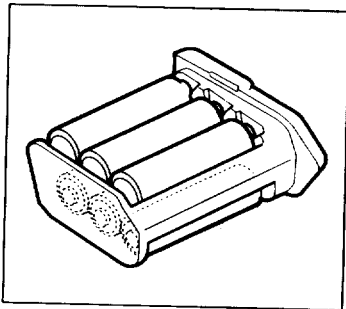

3

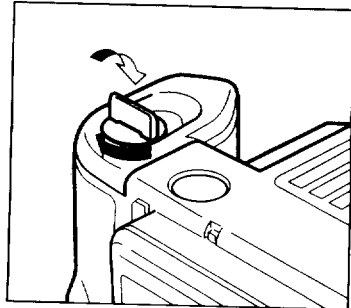

1. To remove the battery holder, lift up the battery holder release knob and turn it in the direction of the arrow.
2. Load six 1.5V AA-size batteries in the battery holder in accordance with the diagram located in the battery holder.

3. To secure the battery holder, turn the battery holder release knob in the direction of the arrow.

- This camera requires battery power for operation. Always use six 1.5V AA size batteries.
- The ISO film speed and number of exposed frames are unchanged even if the batteries are replaced.
- Keep spare batteries on hand for replacement convenience when shooting out doors or while traveling. Using the optional Remote Battery Pack 645 and Power Cord 645 are recommended when the camera is used under the extremely low temperatures.
- Replace all the batteries at the same time. Do not mix battery brands, types or an old batteries with new one.
- Remove batteries when not using the camera for long periods of time. The batteries tend to leak if left too long in the camera.

Battery Life [20°C/68°F]

	Alkaline Battery	Lithium Battery
120 film holder:	about 130 rolls	about 320 rolls
220 film holder:	about 100 rolls	about 250 rolls
Bulb exposure time	about 8 hours	about 12 hours

Battery Life [-10°C/14°F]

	Alkaline Battery	Lithium Battery
120 film holder:	about 7 rolls	about 120 rolls
220 film holder:	about 5 rolls	about 9 rolls
Bulb exposure time	about 6 hours	about 10 hours

- The batteries were used under Pentax testing conditions. Actual battery life and performance may vary drastically depending on external conditions such as temperature and freshness of the battery.
- Battery performance may be temporarily hindered in low temperatures, but should recover in normal temperatures.

TURNING THE POWER ON

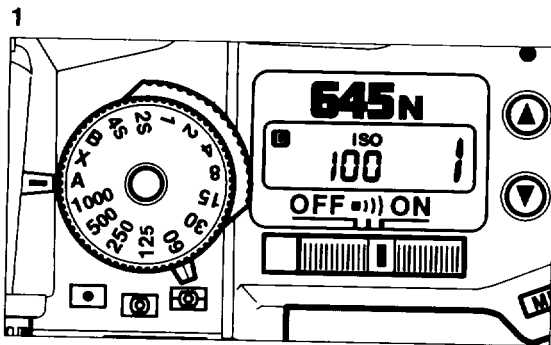

1. Set the main switch to [ON]

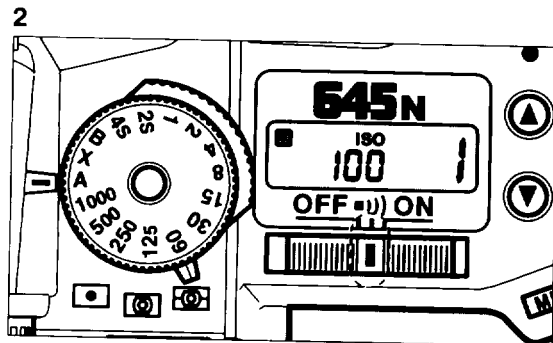

2. With the main switch set to [ON], an audible PCV signal is heard when the subject comes into focus.

- When the camera is not in use, make sure that the main switch is OFF to prevent battery drain if the shutter release button is accidentally depressed.

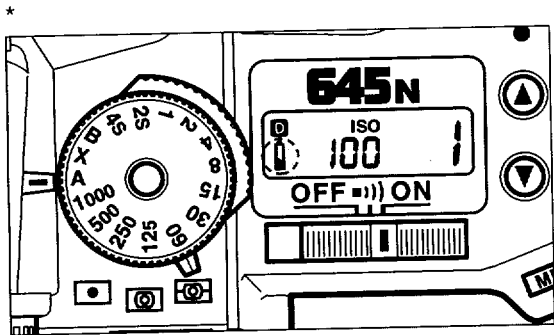

* Low Battery Warning

When the batteries are nearly exhausted, the battery symbol [] appears on the LCD panel as a warning. Replace the batteries as soon as possible. See page 8 for replacing the batteries.

- Even if the low-battery symbol appears, exposure will be correct as long as the shutter can be released. It is recommended to replace the batteries as soon as possible.

ATTACHING THE LENS

BASIC OPERATION (PREPARATION)

1

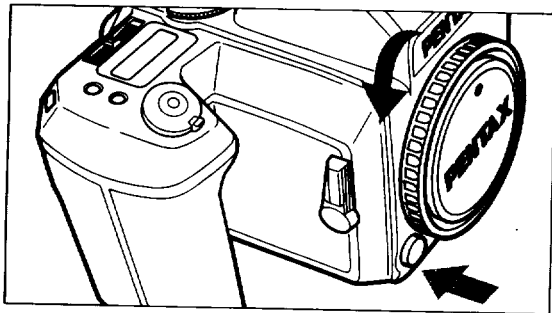

1. Remove the body mount cap while depressing the lens unlock button.

2

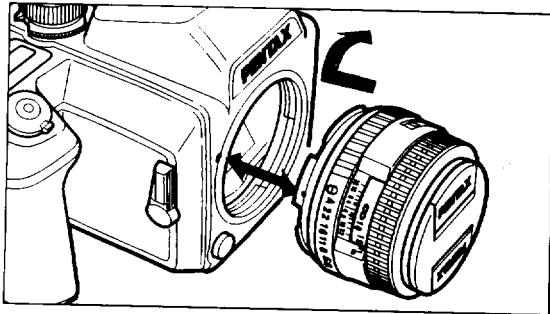

2. Align the red dots on the camera and lens mount, attach the lens to the camera body, and turn it fully to the right until you hear a click.

3

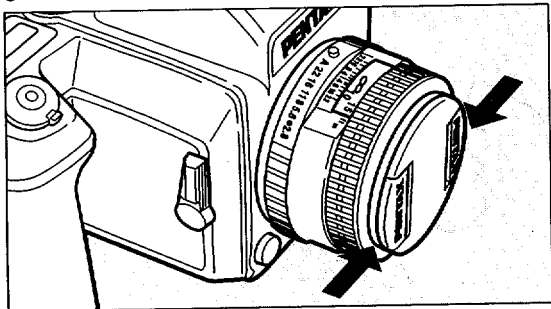

3. To remove the front lens cap, squeeze the tabs on both sides in the direction of the arrow.

- With a non-autofocus lens attached, all available functions in this camera operate except autofocus operation.
- We assume no responsibility nor liability for damages resulting from the use of lenses made by other manufacturers.
- The camera body and lens mount incorporate lens information contacts and an AF coupler. Dirt, dust, or corrosion may cause damage to the electrical system. Clean the contacts with a soft, dry cloth.

*

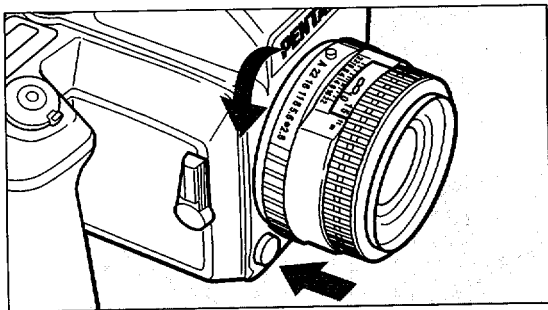

*** How to remove
To remove the lens, turn it to the left while depressing the lens unlock button.**

- To protect the contacts and AF coupler of the lens against damage after removal, be sure to set the lens down with the mount side facing upward.

ATTACHING/DETACHING FILM HOLDER 645

1

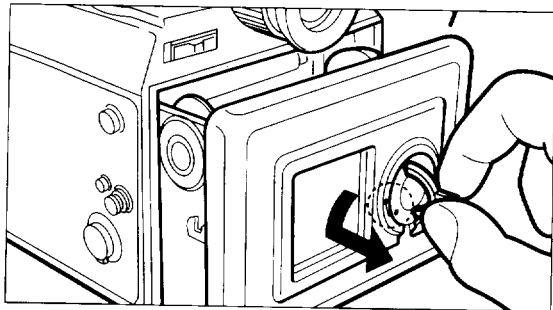

Detaching

1. Raise the film holder knob and turn until the red dot markings align and a click is heard. Continue to turn the film holder knob to the end of the red line; the locking mechanism will release and the film holder is now detached from the camera body.

2

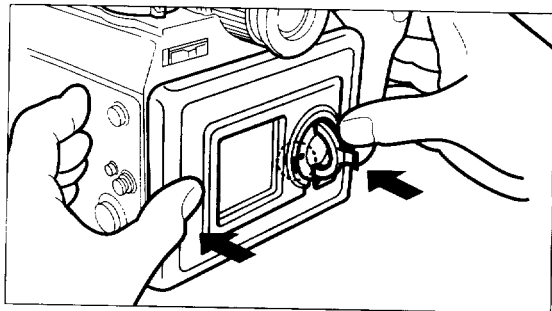

Attaching

2. Align the red dots on the film holder knob and film holder, then insert the film holder into the camera chamber. Depress both sides of the film holder until you hear a click.

3

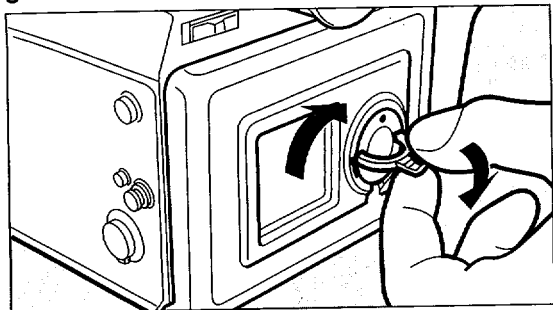

3. Turn the film holder knob 90° to the right. After attaching the film holder to the camera, fold the film holder knob into its original position.

- When inserting the film holder into the camera body, be sure that the film holder is inserted the right way up in order to avoid any serious damage.
- The same precaution is required when attaching the 220 film holder.

DEPRESSING THE SHUTTER RELEASE BUTTON

The shutter release button has two positions. Depressing it down halfway (first position) turns on the exposure meter and autofocus system. Depressing it fully (second position) releases the shutter. When taking a picture, depress the shutter release button gently to prevent camera shake.

- To prevent camera shake, depress the shutter release button gently.
- Before loading a roll of film, slowly depress the shutter release button to learn where the first position is.
- The LCD indication stays on for about 10 seconds after the button is released from the halfway position. Depressing the shutter release button down halfway keeps the LCD indicator on.

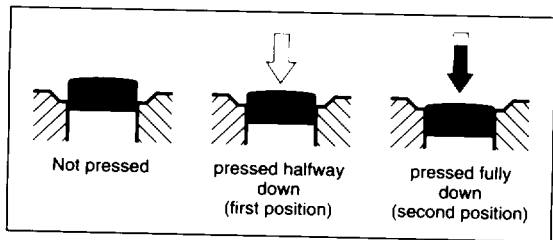

LOADING FILM

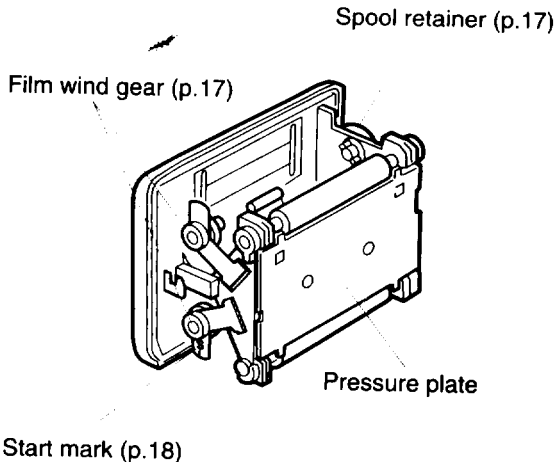

After loading the film, be sure to set the proper film speed. See page 20 for setting the film speed.

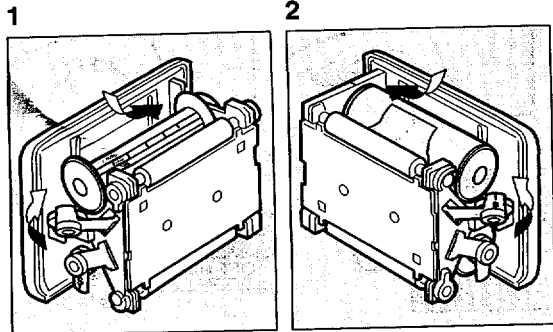

- 1.** Install the emptied spool to the spool retainer as illustrated.
- 2.** Tear off the tape and install the spool to the film holder so that the black inner side of the leading must face outwards.

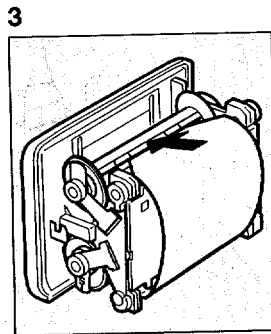
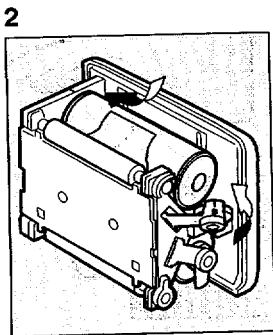

- 3.** Insert the tip of the leader into the take-up spool's slit.
- 4.** Slowly rotate the film winding gear in the direction of the arrow while lightly holding the leader paper.

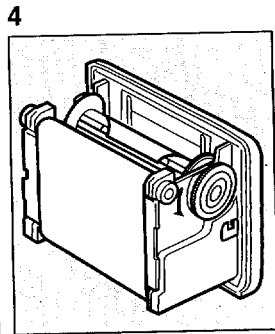

5

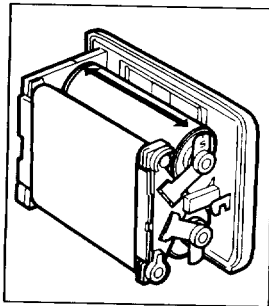

6

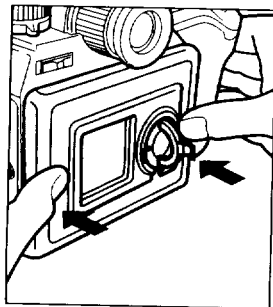

5. Wind the leader paper to the take-up spool until arrow marking on the leader paper aligns with the holder's start mark S and the red line.
6. Attach the film holder to the camera body.

7

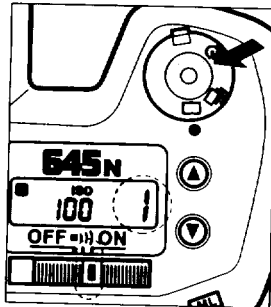

8

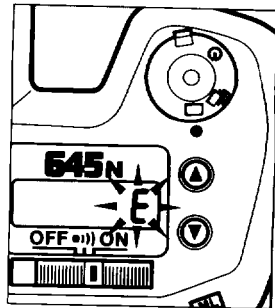

7. Set the main switch to [ON] or [ON]. Release the shutter. The film automatically advances to the first frame. [1] is displayed on the LCD panel.
8. If the [E] appears, indicating that the film is not properly loaded. Detach the film holder from the camera and load the film once again.

- Always load or unload a film in the shade or by using your body to shade the film holder.
- We suggest that you first operate the camera with no film loaded to become familiar with its operations.
- The film counter indication advances one each time the shutter is released.
- With a 220 film loaded, the dot marks appear before the arrow marking. If the dot marks align with the start mark on the film holder, the first 3 frames will not be exposed.
- If the leader paper is wound far beyond the start mark S or the red line, you may lose the last frame(s) on the roll.
- The film holder cannot be changed or removed when the film is in mid-roll.
- 16 pictures are taken with the 120 roll film and 33 pictures are taken with the 220 roll film.

SETTING THE FILM SPEED (ISO)

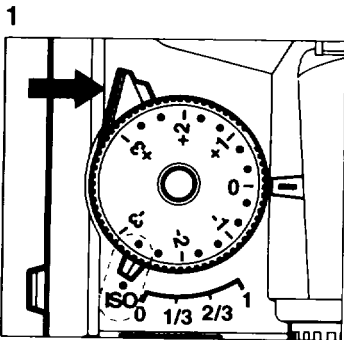

1. Slide the auto bracketing selector to the ISO position.

- The auto bracketing selector returns to the original position when your finger is lifted.

2. While holding the auto bracketing selector at the ISO position, depress the up/down button.

To change the film speed to a larger number (higher film speed), depress the [▲] button repeatedly until the desired ISO appears on the LCD panel. To change the film speed to a smaller number (lower film speed), depress the [▼] button repeatedly until the desired film speed appears on the LCD panel.

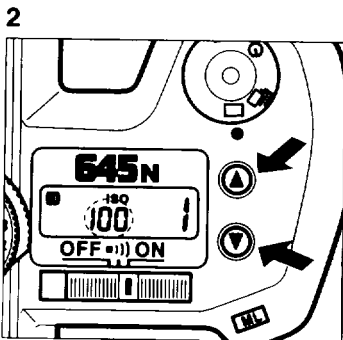

3. After the desired film speed is set, slide the auto bracketing selector to the [0] position.

- [ISO] on the LCD panel blinks when the auto-bracketing lever is set to [ISO].
- The film speed setting range is ISO 6 to 6400 in 1/3 EV step increments.
- You can tear off the end cover of the film package indicating the type of film and speed and insert it into the memo holder provided on the film holder to remind you of the film type/speed that you are using.
- [ISO] and film speed are always displayed on the LCD panel with the main switch set to the ON position.

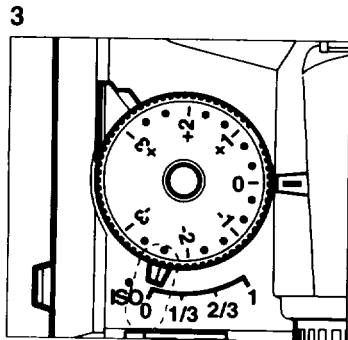

UNLOADING FILM

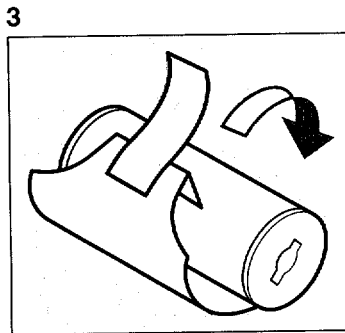
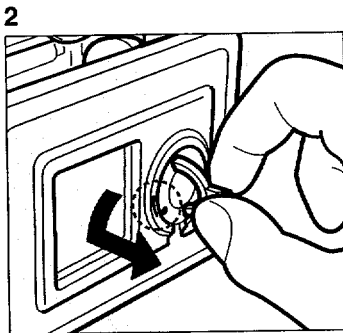
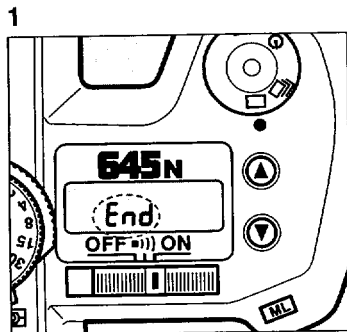

1. After the last frame of the roll is exposed, the camera will automatically wind the film and stops winding as soon as the back of the leader paper is wound to the take-up spool. [End] on the LCD panel is displayed.
2. Detach the film holder from the camera.
3. Fold the tip of leader paper as illustrated. While firmly holding the wound film roll, affix the paper seal securely on the back of the paper leader to prevent from accidental unwinding of the exposed roll.

- Remove the film in the shade or by using your body to shade the camera.
- The number of exposed frames on the LCD panel disappears from the LCD panel.

UNLOADING THE FILM IN MID-ROLL

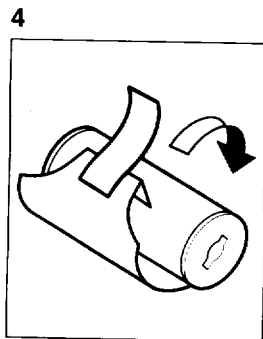
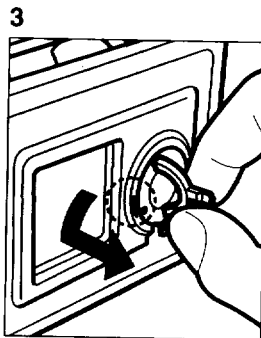
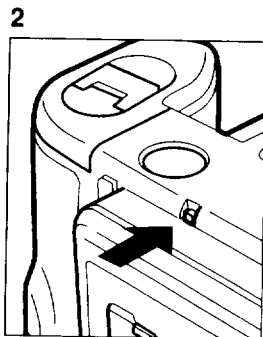
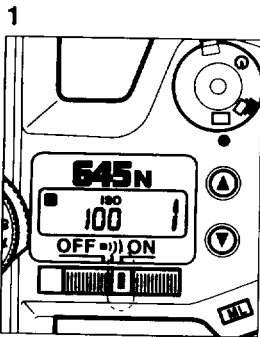

If you wish to remove the film before exposing all the frames, use this function.

1. Set the main switch to [ON].
2. Depress the mid-roll wind-up button with a finger, the film will wind completely.
3. Before detaching the film holder, check that [End] is displayed on the LCD panel.



4. Fold the tip of leader paper as illustrated. While firmly holding the wound film roll, affix the paper seal securely on the back of the paper leader to prevent from accidental unwinding of the exposed roll.

- The number of exposed frames on the LCD panel disappears from the LCD panel.
- When removing the film from the camera, protect it from exposure to direct sun light .

INSTALLING THE EYECUP

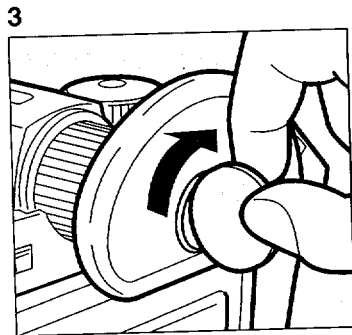
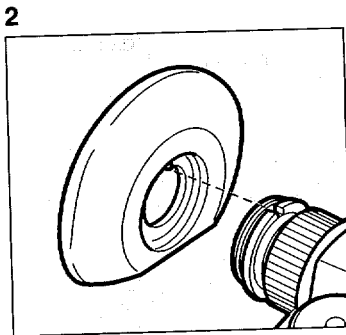
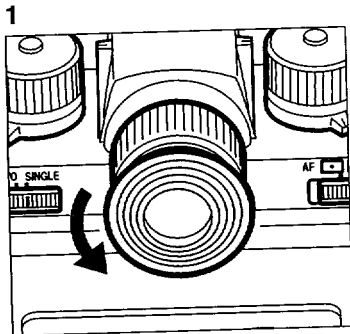

Two types of eyecups, a standard and a larger one are provided as accessories; they may be utilized according to a given situation. The larger is constructed of rubber and designed to fit close to the face for easy shooting.



To install

1. The standard eyecup may be easily removed from the viewfinder by rotating the cup to the left.
2. To install the larger eyecup: match the eyecup pin with fitting eyepiece hole.
3. Turn the fixing screw by turning to the right with a coin or similar object.

- When using accessories such as the Refconverter 645, remove the eyecup first.

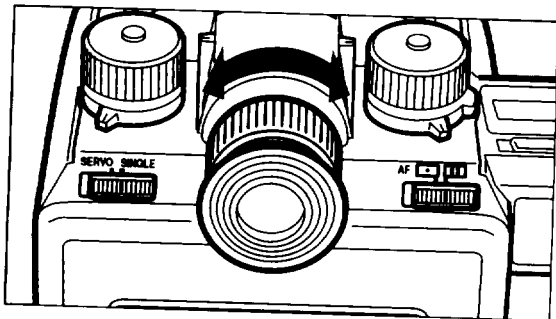
ADJUSTING THE VIEWFINDER DIOPTER



Aim the camera at a bright subject. While looking through the viewfinder, turn the diopter adjustment ring to the left or right until the autofocus frame [ ] appears in the sharpest focus.

- The diopter adjustment range is +1.0D to -3.5D (diopters).

II. BASIC OPERATION (SHOOTING)

USING THE PROGRAMMED AE MODE

1

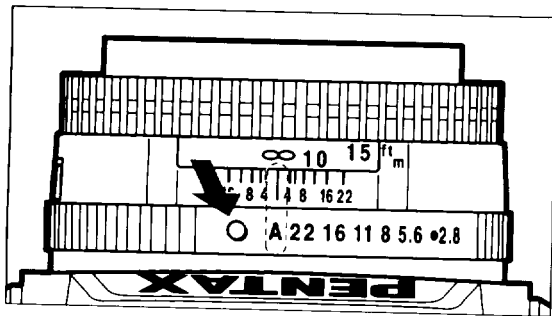

Purpose

For easy picture taking, use this mode. In the Programmed AE mode, the camera automatically selects the best combination of aperture and shutter speed setting allowing you to take pictures by simply depressing the shutter release button.

To set

1. Turn the lens aperture ring to the [A] position as shown in the illustration.
 - To move the lens aperture ring to the [A] position, turn the aperture ring while holding down the aperture-A lock button on the lens. The lens aperture ring can be released from the [A] position in the same manner.

2

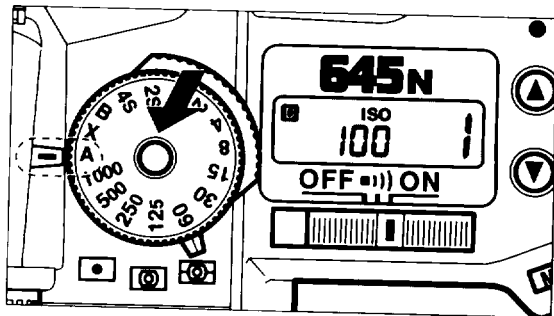

2. Turn the shutter speed dial to [A] while holding down the shutter speed dial release button. The shutter speed dial can be released from [A] in the same manner.
 - See page 40, 42, 44, and 46 for other available exposure modes.

USING THE MULTI(6)-SEGMENT METERING MODE

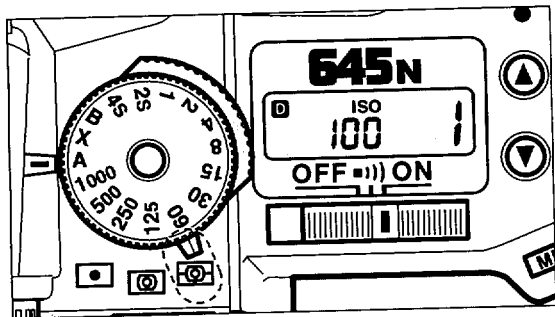

In the multi(6)-segment metering mode, the metering system automatically measures light in six different zones, enabling proper exposure value in a wide variety of normal and adverse lighting conditions.

Set the metering mode switch to [].

- The center-weighted metering mode and spot metering mode are also available in this camera. See page 50 and 51 for more details.
- When the Adapter 645 for 67 lens or Helicoid Extension Tube 645 is attached, the center-weighted metering mode is automatically set even if you select the multi-segment metering mode. The multi-segment metering mode cannot be used.

MULTI(6)-SEGMENT METERING

This camera incorporates a high-precision six-segment TTL metering system. Light values are measured in six segments within the image field, enabling an optimal exposure to be made under a variety of lighting conditions. With conventional averaged metering systems, underexposure of the subject results from the brightness of the background affecting the overall metering. With multi(6)-segment metering, the camera records the brightness in six zones within the image field and uses these measurements to choose an exposure that will not underexposed the subject. The multi(6)-segment metering system also calculates exposure values for a scene to automatically compensate for high-contrast and other difficult lighting conditions. Even a beginner can achieve excellent results with ease.

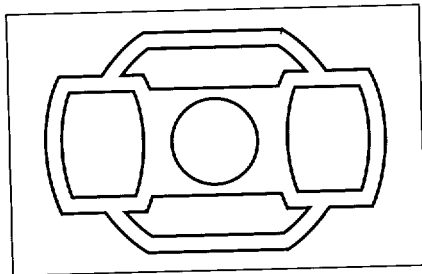

USING AUTOFOCUS MODE

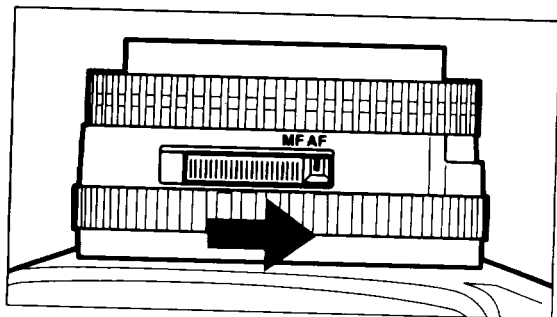

With the Pentax 645 FA lens attached, the lens automatically focuses when you press the shutter release button halfway down.

Set the lens in the autofocus mode.

- Switching between the autofocus mode and manual focus mode depends on the lens you use. For more details, read the operating manual of the lens.
- The camera does not provide the switch for switching between the autofocus mode and manual mode.

USING THE SINGLE AF MODE

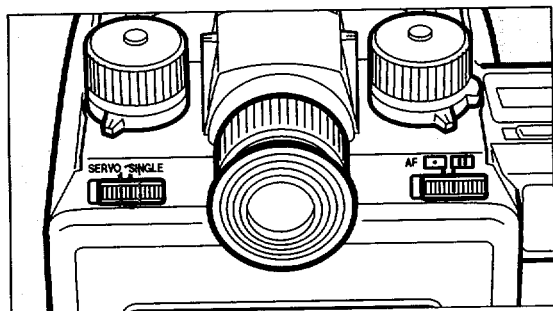

When you depress the shutter button, the lens automatically focuses. As soon as the subject is in focus, the shutter is released. For normal use, select this position. The shutter cannot be released if the subject is out of focus.

Set the AF mode selector to [SINGLE].

- Servo AF Mode is also available in this camera. See page 53.

USING THE 3-POINT AF MODE

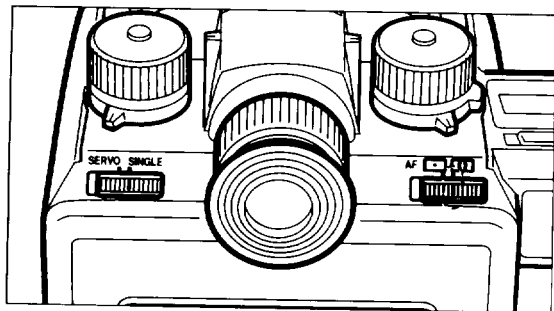

In the 3-point autofocus system, the subject will be focused properly even if the main subject is slightly off-center of the AF frame.

Set the AF mode selector to [].

USING THE SINGLE-FRAME DRIVE MODE

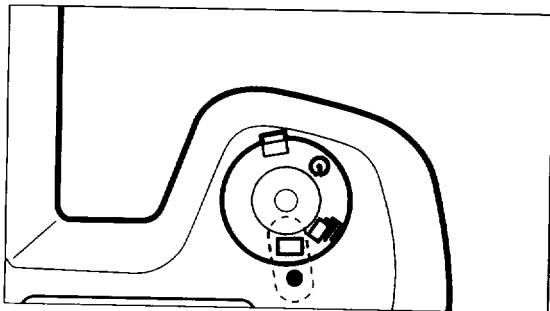

One picture is taken each time the shutter release button is depressed.

Set the drive mode dial to [].

HOLDING THE CAMERA

Camera held horizontally

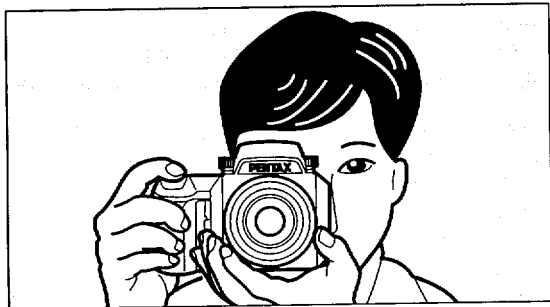

For best results, be sure to hold the camera correctly as shown in the illustrations.

Hold the camera firmly, with your left hand supporting the camera and lens as shown in the illustrations. While taking a picture, hold your breath and gently depress the shutter release button. (Sudden force on the shutter release button will cause camera shake, making the picture blurred.)

Camera held vertically



- To reduce camera shake, support your body or the camera on a solid object - a table, tree, or a wall for instance.
- Although there are individual differences among photographers, in general the shutter speed for a hand held camera is the inverse of the focal length. For example, 1/75 of second when the focal length is 75mm, and 1/150 of second when it is 150mm. A tripod should be used for shutter speeds slower than this.
- When using an ultra-telephoto lens, a tripod that is heavier than the total weight of the camera and lens is recommended to avoid camera shake.
- This camera has provided two tripod sockets for vertical and horizontal format positions.
- When the tripod is used, use of an optional Cable SW F or Cable Release is also recommended.

TAKING A PICTURE

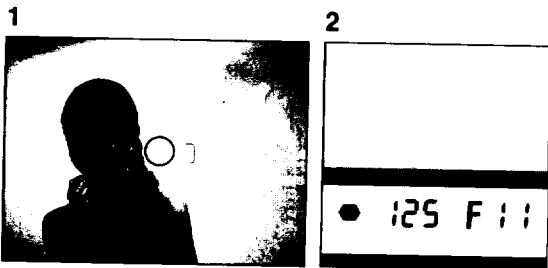

Set the lens to the autofocus position.

1. Focus on the subject with the 3-point AF frame [] indicated in green in the photograph. When the shutter release button is depressed halfway down, the lens automatically focuses.
2. When the subject is in focus, the focus indicator [] lights up.
3. To release the shutter, gently depress the shutter release button fully.

- When the shutter release button is depressed halfway down, the shutter speed and aperture setting are displayed in the viewfinder.
- Select the Spot AF Mode to critically focus on a specific spot of the subject. See details on page 54.
- When the subject is in focus, the audible PCV signal can be emitted. See details on page 10.
- During autofocus operation, the focusing ring should not be obstructed with your fingers, hands, or any other object.

The focus indicator [] blinks when the camera is not able to obtain proper focus for one of the following reasons.

1. The subject is too close. Adjust the camera-to-subject distance.
2. The subject is difficult to autofocus. See "HARD-TO-AUTOFOCUS" on page 58.

- The shutter cannot be released if the subject is out of focus.
- The film counter indication advances each time the shutter is released.
- Depress the shutter release button halfway down. While [O] is on, the camera-to-subject distance is fixed (focus lock). To refocus on another subject, lift your finger off the shutter release button.
- If the drive mode switch is set to the Consecutive-Frame Mode with the Single AF Mode set, the camera focuses only the first picture. From the second picture, the pictures are taken consecutively with the focus locked at the first picture.



III. ADVANCED OPERATIONS

SELECTING A DRIVE MODE

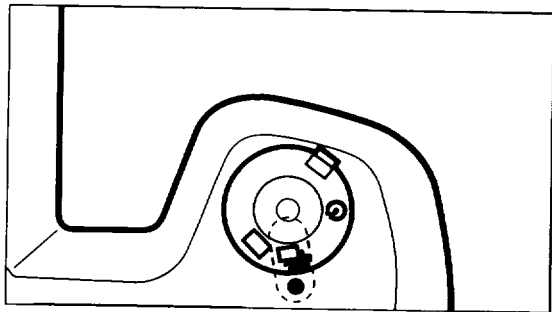

1. Consecutive-Frame Mode

Consecutive pictures can be taken by holding down the shutter release button.

Set the drive mode selector to [].

- If the AF mode selector is set to [SINGLE], the camera focuses only the first picture. From the second picture, the pictures are taken consecutively with the focus locked at the first picture.

1

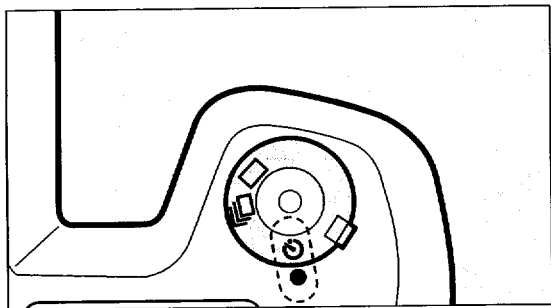

2. Self-Timer Mode

The self-timer mode delays the shutter release, and is useful for taking group shots that include the photographer. The shutter will be released about 12 seconds after the shutter release is depressed.

1. Set the drive mode selector to [].

2

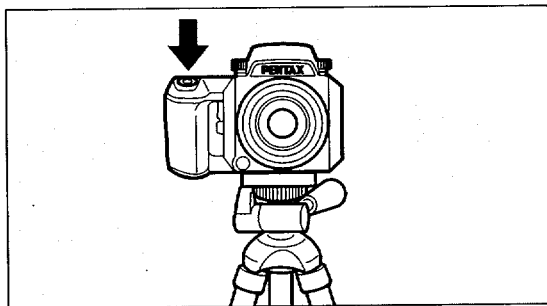

2. Focus on the subject first using the autofocus frame and by depressing the shutter release button halfway down. Then depress the shutter release button fully.

- The shutter will be released about 12 seconds later.
- When the self-timer is in operation, the audible PCV signal is heard and the rate increases for the last two seconds.
- To cancel the self-timer operation after it has been activated, move the drive mode selector to a position other than [] or set the main switch to the OFF position.

MULTIPLE EXPOSURE MODE

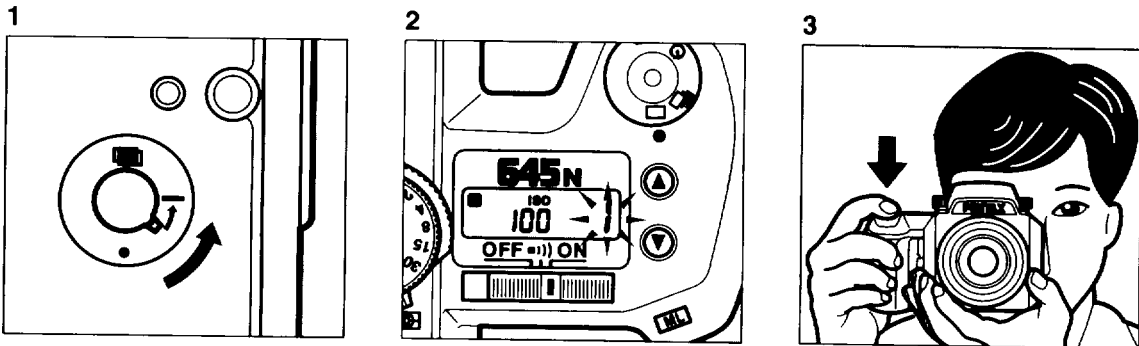

Procedure

1. Turn the multi-exposure switch in the direction of the arrow until it locks.
2. The frame counter on the LCD panel blinks.

3. Depress the shutter release button to shoot an initial exposure. The film will not advance.

4

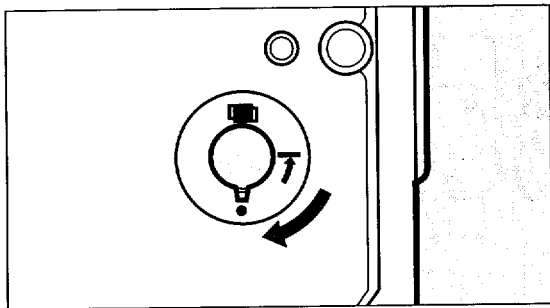

4. Return the multi-exposure switch to the original position to cancel the multi-exposure mode.

Notes:

- To exposure the third shot, leave the multi-exposure switch in the lock position in step 3 to shoot the second shot. Then return the multi-exposure switch to the original position. The film does not advance at on this stage. Depress the shutter release button to shoot the third shot. The film will advance and the single-frame shooting will be restored.

5

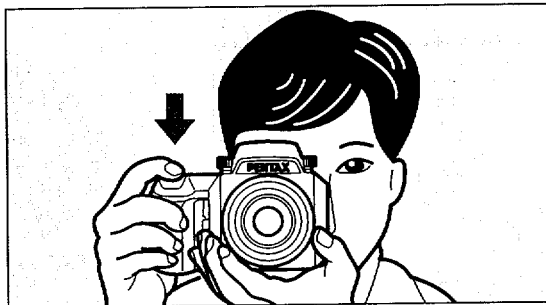

5. Recompose the frame, and depress the shutter release button to shoot the second shot.

- When using the Multi-Exposure Mode, you usually get the best result using a flash to illuminate the main subject against a dimly-lit background.
- To cancel the Multi-Exposure Mode, turn the multi-exposure switch to the original position.



SELECTING AN EXPOSURE MODE

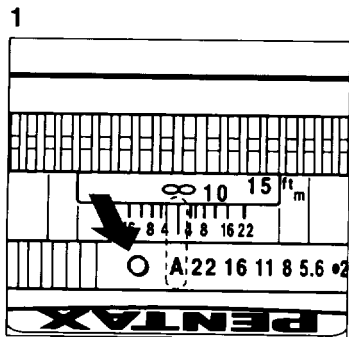

1 Using the Programmed AE Mode

Purpose

The camera automatically selects the optimum combination of shutter speed and aperture setting, making it easy to take a good photograph by just depressing the shutter release button.

How to

1. Set the lens aperture ring to [A].

- Turn the lens aperture ring while holding down the aperture-A lock button.

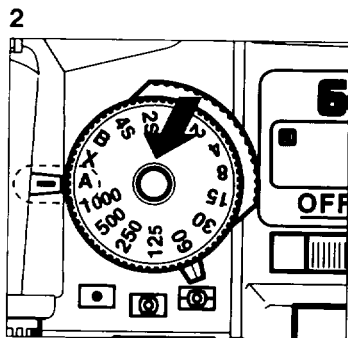

2. Turn the shutter speed dial to [A] while holding down the shutter speed dial lock button.

- The shutter speed dial can be released from [A] to another position in the same manner as above.
- When the shutter release button is depressed halfway, the shutter speed and aperture setting will be displayed in the viewfinder.

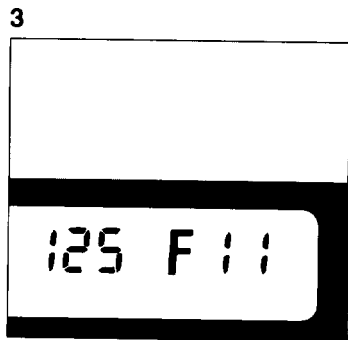

*

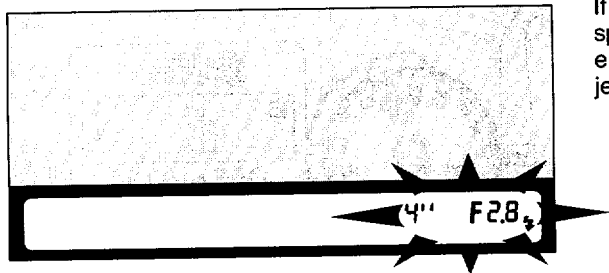
*** Exposure Warning**

If the subject is too bright or too dark, the shutter speed and aperture setting will blink in the viewfinder. If the subject is too bright, select a darker subject. Use a flash if the subject is too dark.





1

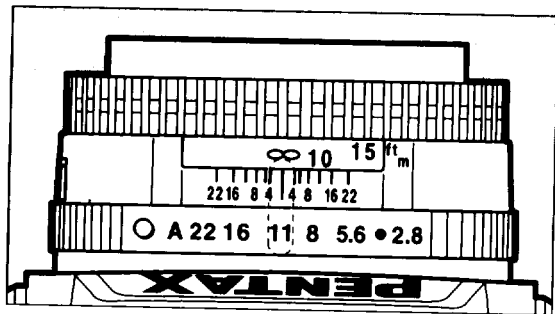

Using the Aperture-Priority AE Mode

Purpose

When the desired aperture is selected, an appropriate shutter speed is automatically set by the camera for a proper exposure. This mode is ideal for shooting landscapes with increased depth of field, or a portrait against a blurred background.

How to

1. **Set the lens aperture ring to the desired f-stop other than [A].**

- Turn the lens aperture ring while holding down the aperture-A lock button.

2

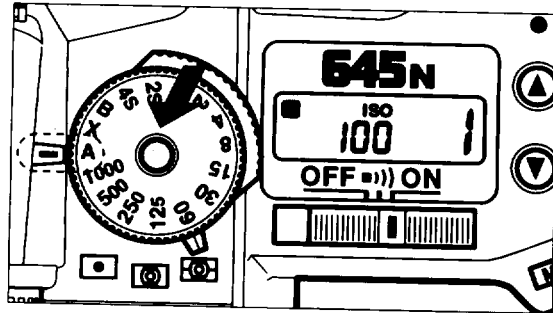

2. **Set the shutter speed dial to [A].**

- The shutter speed dial can be released from [A] to another position while holding down the shutter speed dial lock button.

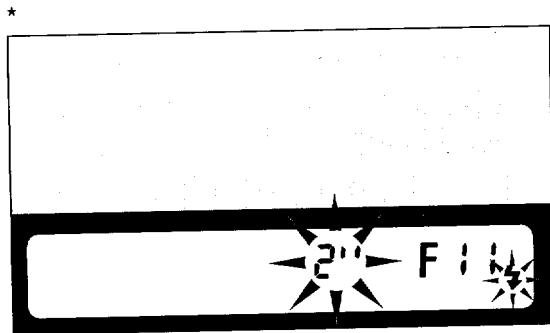
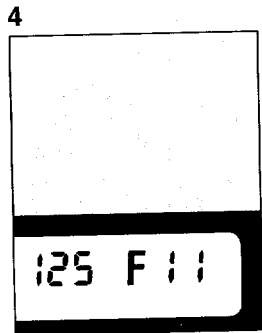
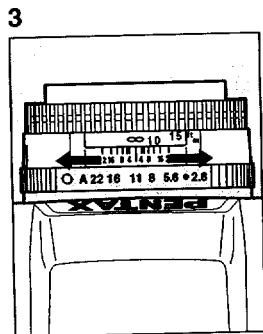

3. Set the desired f-stop.

4. The f-stop that you have selected and appropriate aperture indication determined by the camera can be seen in the viewfinder when the shutter release button is depressed halfway.

- The approximate aperture indication appears in the viewfinder. It may not be the same indication as you select the lens aperture ring especially when the A 645 150mm f/3.5 or A 645 45 - 85mm Zoom f/4.5 is attached.

* Exposure Warning

If the subject is too bright or too dark, the selected shutter speed will blink in the viewfinder and on the LCD panel as a warning as shown. When the subject is too bright, choose a smaller aperture, if available; when it is too dark, choose a larger aperture, if available. When the shutter speed indication stops blinking, you can take the picture. If both shutter and aperture blink, it means that the exposure is out of metering range, unable to obtain a correct exposure even if the aperture is adjusted. Select a darker subject if it is too bright, or use a flash if it is too dark.

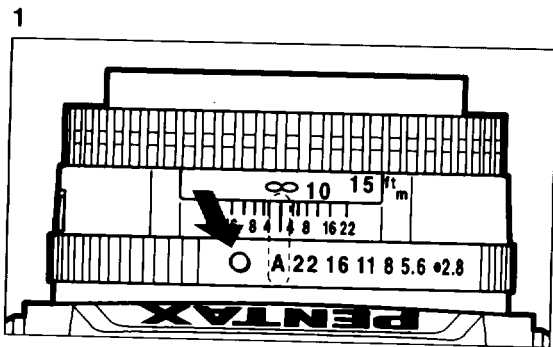

Using the Shutter-Priority AE Mode

Purpose

When the desired shutter speed is selected, the appropriate aperture is automatically set by the camera for a proper exposure according to the brightness of the subject. This mode is suitable for freezing the action with a fast shutter speed or capturing a flowing dynamic image with a slow shutter speed.

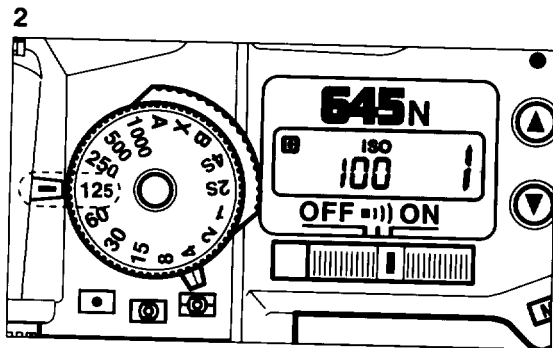

To set

- 1. Set the lens aperture ring to [A].**
 - While holding down the shutter speed dial lock button, turn the shutter speed dial to the desired shutter speed.
- 2. Set the shutter speed dial to a shutter speed other than [A].**
 - To set the shutter speed dial to a position other than [A], turn the shutter speed dial while holding down the shutter speed dial lock button.

3

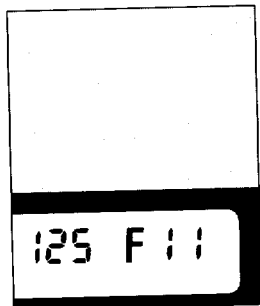
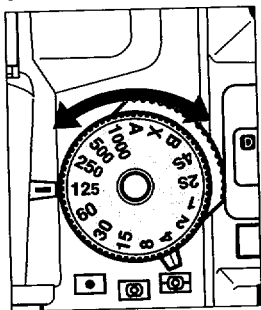

3. Set the shutter speed dial to the desired shutter speed.

- When the shutter release button is depressed halfway down, the shutter speed and the aperture value will be displayed in the viewfinder.
- In flash photography, when you use the flash sync shutter speed of 1/60 second or a non-dedicated external flash unit, set the shutter speed dial to the [X] (1/60 of second) position.

*

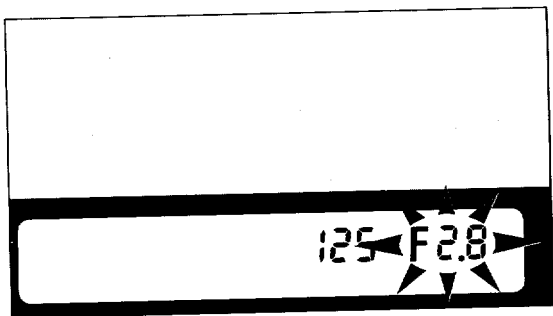

* Exposure Warning

If the subject is too bright or too dark, the shutter speed and aperture setting in the viewfinder blink. When the subject is too bright, choose a faster shutter speed. If it is too dark, choose a slower shutter speed. When the shutter speed indication stops blinking, you can take the picture. If both selected shutter speed and aperture blink, it means that the exposure is out of metering range, unable to obtain a correct exposure even if the shutter speed is adjusted. Select a darker subject if the subject is too bright. Use a flash if it is too dark.



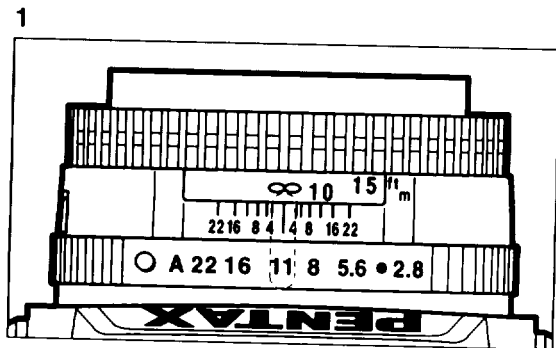

Using the Metered Manual Mode

Purpose

The Metered Manual Mode is a convenient exposure mode for taking pictures using the same shutter speed and aperture setting combination, or taking creatively under or overexposed photographs.

To set

1. Set the lens aperture ring to the desired f-stop setting.

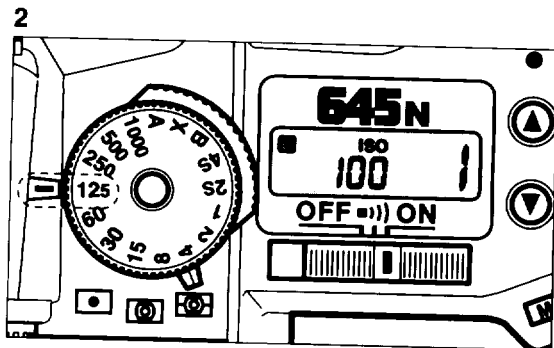

2. Set the shutter speed dial to the desired shutter speed.

- To set the shutter speed dial to a position other than [A], turn the shutter speed dial while holding down the shutter speed dial lock button.
- Turn the lens aperture ring while holding down the aperture-A lock button.
- The approximate aperture indication appears in the viewfinder. It may not be the same indication as you select the lens aperture ring especially when the A 645 150mm f/3.5 or A 645 45 - 85mm Zoom f/4.5 is attached.

3

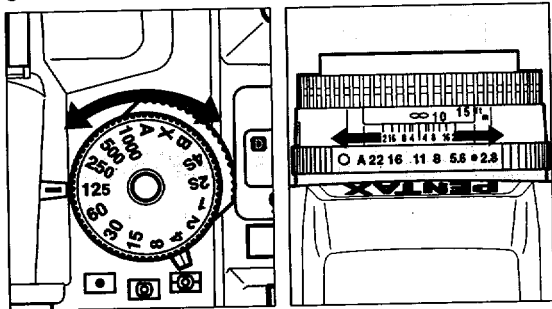

3. Turn either the shutter dial or lens aperture ring until a single bar is displayed in the center of the bar graph.
 4. When the shutter release button is depressed halfway, the shutter speed, approximate aperture and bar graph will be displayed in the viewfinder.
- When the bars are displayed to the [+] side on the bar graph, it indicates overexposure and when the bars are displayed to the [-] side, it indicates underexposure.
 - Moving one bar on the bar graph indicates 0.3 step (0.3EV). However, when under or over exposure is set beyond + 3 or - 3 steps (3EV), [+] or [-] indicator will blink.

4

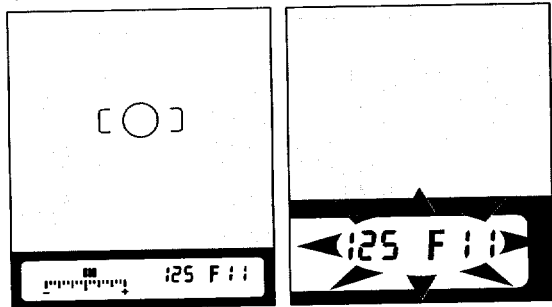

- In flash photography, when you use the flash sync shutter speed of 1/60 second or a non-dedicated external flash unit, set the shutter dial to the [X] (1/60 of second) position.

* Exposure Warning

If the subject is too bright or too dark, the selected shutter speed will blink in the viewfinder as a warning as shown. When the subject is too bright, choose a smaller aperture; when it is too dark, choose a larger aperture. When the shutter speed indication stops blinking, you can take a picture. If both shutter and aperture blink, it means that the exposure is out of metering range, unable to obtain a correct exposure even if the aperture is adjusted. Select a darker subject or use a flash if it is too dark.

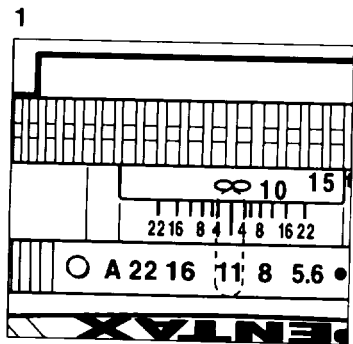

1 Using the Bulb Exposure Mode

Purpose

This mode is useful for the long exposures required for shooting night scenes and fireworks. The shutter remains open as long as the shutter release button is held down.

How to

1. Set the lens aperture ring to the desired f-stop other than [A] while holding down the aperture-A lock button.
- Do not set the lens aperture ring to [A]. If doing so, the aperture will always closed to the maximum position.

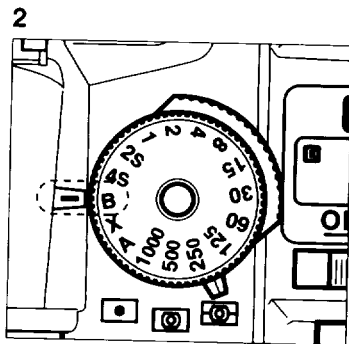

2. Set the shutter speed dial to [B].

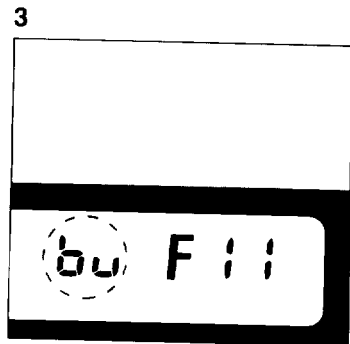

3. An appropriate aperture will be displayed in the viewfinder when the shutter release button is depressed halfway.

- Set the shutter speed dial to the [B] position. Turn the shutter speed dial while holding down the shutter speed dial lock button.
- The approximate aperture indication appears in the viewfinder. It may not be the same indication as you select the lens aperture ring especially when the A 645 150mm f/3.5 or A 645 45 - 85mm Zoom f/4.5 is attached.

4

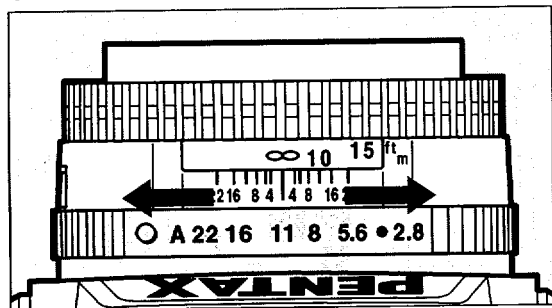

4. Adjust the desired aperture by lens aperture ring.

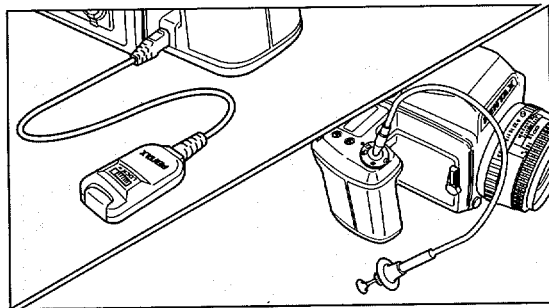

- When using this mode, use a steady tripod to prevent camera shake and attach the optional "Cable Switch F" after removing the Release Socket Cap F.
- Up to approx. 8 hours of time exposure are possible with new alkaline batteries at room temperatures.

ABOUT EXPOSURE COMPENSATION

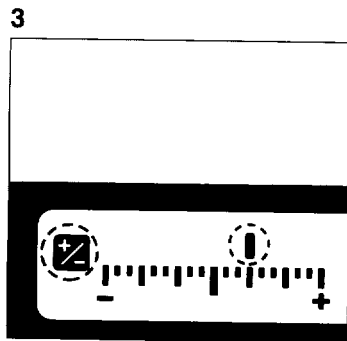
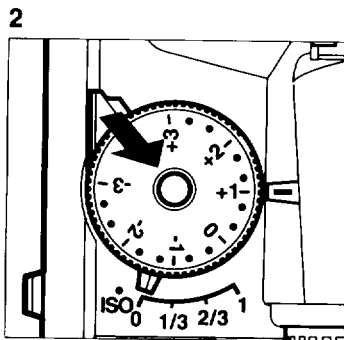
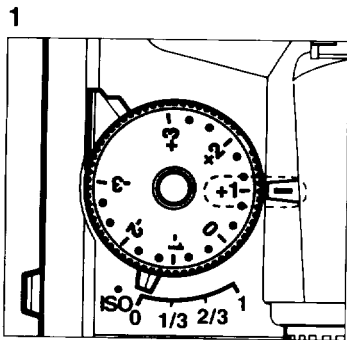

Purpose

The exposure compensation allows you to deliberately overexposure (brighten) or underexposure (darken) a subject, or to compensate for difficult lighting conditions which may fool the camera's built-in exposure meter.

To set

1. Turn the exposure compensation dial to the desired compensation value.
2. The exposure compensation dial locks at the [0] position. To set the exposure compensation dial to a position other than the [0] position, turn the exposure compensation dial while holding down the exposure compensation dial release button.

3. The bar graph indicates the compensation value and [] appear in the viewfinder.

- Exposure compensation does not work in the Bulb Exposure Mode.
- The exposure compensation range is -3EV to +3EV in 0.5EV step.
- Moving one bar on the bar graph indicates 0.3EV step.
- When exposure compensation is used in the Metered Manual Mode, the bar above the bar graph indicates under or overexposure, it is not indicating the exposure compensation value. [] is displayed.

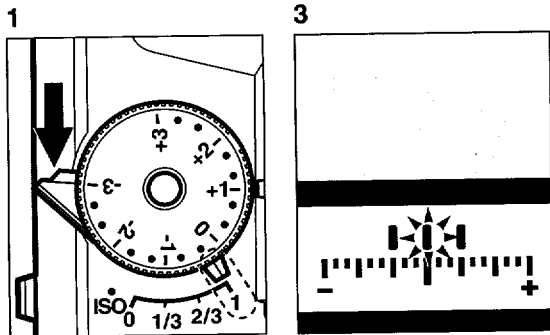

When you take a picture that requires the exposure compensation and it may be difficult to obtain the correct exposure, use this mode to make three different bracketed exposures with different exposure levels. The exposure can be bracketed in 1/3EV, 2/3EV or 1EV steps.

1. Set the auto bracketing selector to the desired exposure compensation value.
2. Depress the shutter release button fully. Three pictures are taken consecutively according to the auto-bracketing switch you have set.

• If the auto bracketing selector is set to 1, three pictures are taken consecutively as follows.

First picture: Correct exposure
 Second picture: 1.0 EV underexposure
 Third picture: 1.0 EV overexposure

3. For example, if the auto bracketing selector is set to [1], [■] blinks on the bar graph in the viewfinder in the following order.

Before shooting 1st frame: dot in the center blinks
 Before shooting 2nd frame: dot on -1 blinks
 Before shooting 3rd frame: dot on +1 blinks

- Moving one bar on the bar graph in the viewfinder indicates 0.3 EV step.
- The focus is locked at the first picture and remains locked until all pictures are taken.

Auto Bracketing Exposure Mode combined with the Exposure Compensation function.
 You can combine the Auto Bracketing Exposure Mode with exposure compensation function.
 Example: With the exposure compensation dial set +2 and auto bracketing selector set 1EV

First picture	2.0EV overexposure
Second picture	1.0EV overexposure
Third picture	3.0EV overexposure

SWITCHING THE METERING MODE

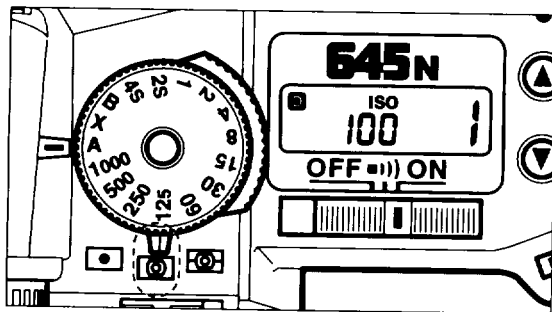

The Spot metering or center weighted metering mode can also be selected in this camera. Select the desired metering mode with the metering mode selector.

Using the Center-Weighted Metering Mode

This metering system does not automatically compensate for backlit or spotlighted scenes like the Multi(6) - Segment Metering Mode. Creative exposure control is decided by the user.

To use

Set the metering mode selector to the [] position.

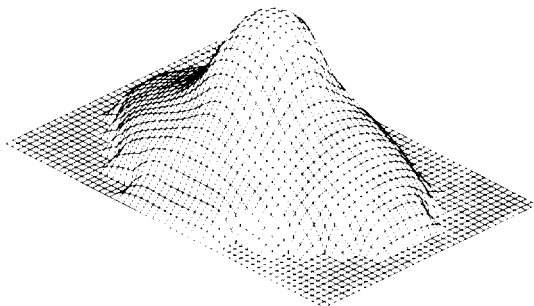

- The metering pattern in the illustration above shows that the upper part of the pattern (in the center of the viewfinder) has more sensitivity to light than the lower part.
- In this metering mode, the camera does not automatically compensate the exposure in backlit or spotlighted situations like the Multi (6) - Segment Metering Mode. Creative exposure control is decided by the user.

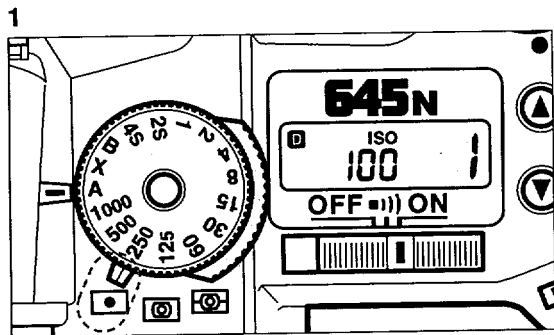

Using the Spot Metering Mode

The Spot Metering Mode measures light only in the small area in the center of the viewfinder.

To set

1. Set the metering mode selector to [].

2

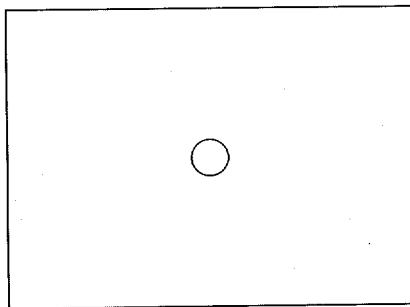

2. Measure the small area of the viewfinder as illustrated.

- If the brightness range between area in the photograph is too great, the exposure should be determined in consideration of the overall brightness. Otherwise, the picture will come out improperly exposed.

USING MEMORY LOCK

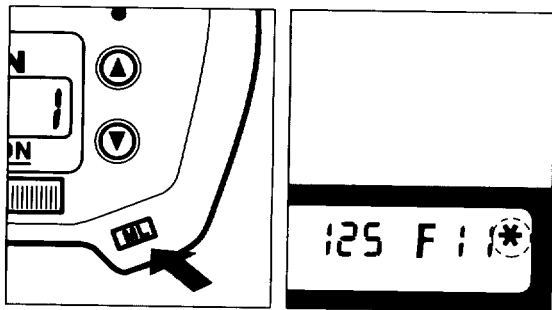

The memory lock function enables an exposure level to be memorized before shooting. The memory lock function is very effective when used along with spot metering. Use the memory lock function to get a correct exposure when the subject occupies only a small part of the viewfinder.

Position the area to be measured in the spot metering area and depress the memory lock button. The exposure level is memorized and [*] is displayed in the viewfinder.

- As soon as the memory lock button [ML] is depressed, and the camera stores the measured exposure level for 20 seconds. The memory lock function remains while the memory lock button is depressed.
- If the shutter release button is depressed halfway down while the memory lock timer is operating, the memorized meter reading will remain even if the memory lock button is released.
- The memory lock function cannot be used when the camera is set in the Metered Manual Mode.

How to cancel

To cancel the memory lock function, depress the memory lock button again.

SETTING THE FOCUS MODE SWITCH TO THE SERVO POSITION

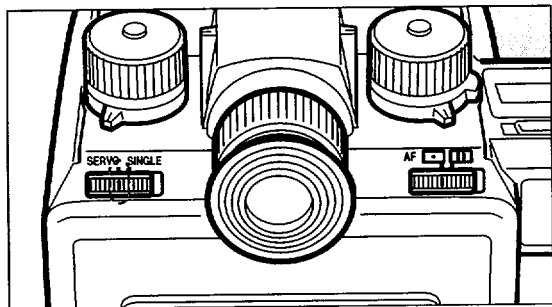

If the shutter release button is held at the halfway position, the lens focuses continuously to follow the subject. The shutter can be released even if the subject is out of focus.

Set the focus mode switch to [SERVO].

Predictive Autofocus Mode

When the camera senses subject movement during the autofocus operation, the camera will automatically switch the focus mode to the predictive autofocus mode to measure the speed of a moving subject, and predict where it will be at the moment of shutter release to maintain sharp focus on the subject. If the subject is moving too fast, the shutter may not be released.



USING THE SPOT AF MODE

1

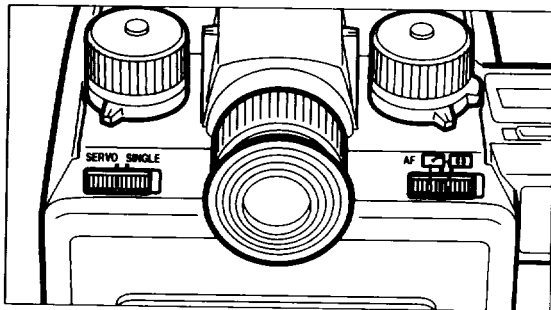

Select the Spot AF Mode to critically focus on a specific spot of the subject which is in the spot AF autofocus frame.

How to focus

1. Set the AF frame selector to [].

2



2. Focus on the main subject with the Spot AF frame [indicating in green in the illustration].

- When the main subject is off the Spot AF frame, use the focus-lock technique. See page 55.

FOCUS LOCK FUNCTION

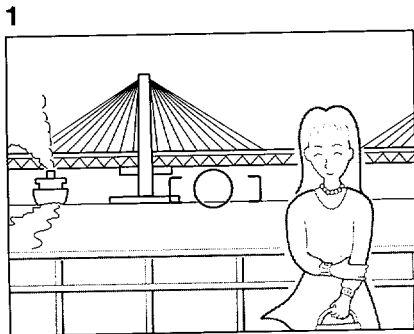

In the Spot Metering Mode, the camera focuses with the spot metering / focusing area of the viewfinder. If you shoot without positioning the spot metering / focusing area on the main subject, the main subject will not be focused properly.

Set the AF frame selector to [].

1. When the composition does not allow the autofocus frame to be placed over the most important subject, the camera will focus on the background as shown in the illustration.

- The focus lock can be used in the 3-point AF Mode and Spot AF Mode.
- The focus lock does not operate when the AF mode selector is at [SERVO].

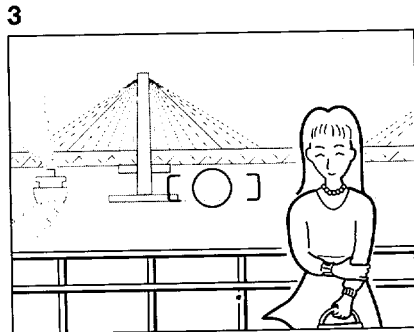
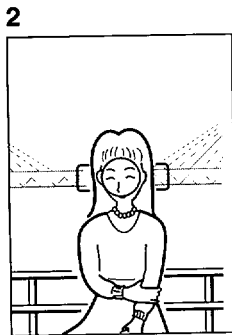

2. To prevent this, focus on the main subject with the spot metering / focusing area. Depress and hold the shutter release button halfway down. The in-focus indicator remains on, indicating that the focus is temporarily locked.
3. While holding the shutter release button halfway down, re-aim the camera or recompose the picture, then depress the shutter release button fully to release the shutter.

- Lifting your finger off the shutter release button clears the in-focus indicator [] in the viewfinder and cancels the focus lock function.
- To refocus on another subject, lift your finger off the shutter release button.

MANUAL FOCUSING

1

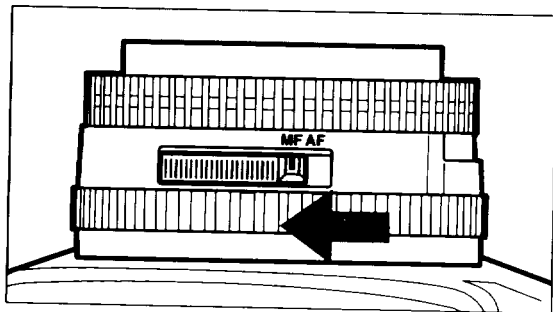

Using the in - focus indicator

How to focus

1. Set the lens in the manual focus mode.

- Switching between the autofocus and manual focus modes depends on the lens you use. For more details, read the operating manual of the lens.

2

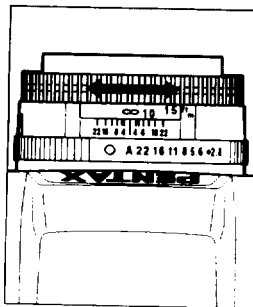

3

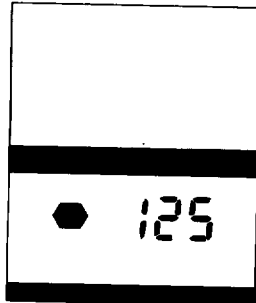

- 2. While looking through the viewfinder, turn the focusing ring to the right or left while holding the shutter release button halfway down.**
- 3. When the subject comes into focus, the in - focus indicator [] lights up in the viewfinder. Depress the shutter release button fully to take the photograph.**

- The camera is not equipped with the focus mode selector.
- When the subject comes into focus, the focus indicator [○] lights up in the viewfinder. An audible PCV signal can be heard if the main switch is set to the [○] position.
- The in-focus indicator can also be used when a non-autofocus lens with a maximum aperture of f/5.6 or larger (f/2.8 to f/5.6), the Auto Extension Tube - A 645 or Rear Converter A 645 is attached.

When the autofocus mode or the in-focus indicator is unsuited for focusing

When the autofocus function or the viewfinder's in-focus indicator [○] cannot be used when the subject on the AF frame is difficult to autofocus. Focus the subject in the manual focus mode with the aid of the matte field in the viewfinder as you would with a non-AF SLR camera.

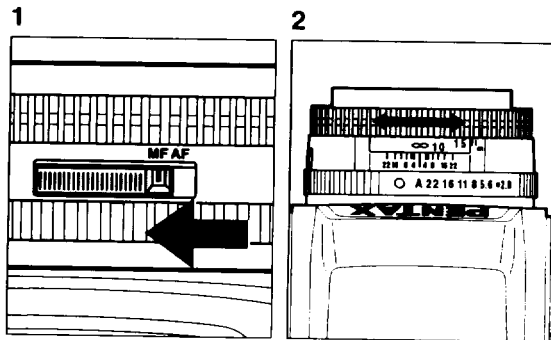

How to focus on the subject with the aid of the matte field

1. Set the lens in the manual focus position.
2. While looking through the viewfinder, turn the focusing ring to the right or left until the image in the viewfinder is clearest.

HARD-TO-AUTOFOCUS SUBJECTS

The autofocus system is highly precise, but not perfect. Depending on the brightness, contrast, shape, and size of your subject, the autofocus system may not operate. In such a case, use the focus-lock technique (see page 55.) on another subject that is the same distance away, or set the lens to use the manual focus mode to focus the lens on the subject with the aid of the matte field in the viewfinder.

Subjects which may fool the autofocus system include:

- a) Extremely low-contrast subjects such as a white wall in the autofocus frame [[]].
- b) Subjects which don't reflect much light in the autofocus frame [[]].
- c) Subjects which are moving too fast.
- d) Multiple subjects in the foreground and background of the autofocus frame [[]].
- e) Subjects positioned against reflected light or strong backlight or with extremely bright backgrounds.
- f) Subjects with horizontal lines or with finely complex or detailed patterns in the AF frame.

Notes on Accessories

The following conditions do not allow autofocusing or manual focusing with the in-focus indicator in the viewfinder. Use the manual focus mode to focus on the subject with the aid of the matte field surrounding the autofocus frame. See page 58 for manual focusing.

- a) When using special effect filters or "Magic Image Attachment".
- b) When using Extension Tubes or an Auto Bellows for close-up photography.

Using A Polarizing Filter

When using an ordinary polarizing filter; the half mirror incorporated into the autofocus system reduces the effectiveness of the autofocus function when used in combination with an ordinary polarizing filter. Use a CIRCULAR POLARIZING FILTER for proper autofocus operation.

IMPRINTING THE EXPOSURE DATA ON THE NEGATIVE

If a 645 A- or FA lens (autofocus lens) is attached, the camera imprints the following exposure data directly on the negative, outside of the picture frame with each exposure.

- Number of Frames
- Exposure Mode
- Shutter Speed
- Aperture Setting
- Exposure Compensation Value
- Metering Mode
- Focal length of Lens

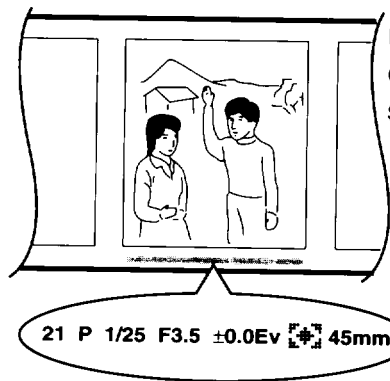

- Multi-Segment Metering Mode —
- Center-Weighted metering Mode —
- Spot metering Mode —

If [M] is displayed on the LCD panel, the exposure data will be imprinted on the negative.

- With a 645 A- lens attached, the exposure data but not the focal length of the lens will be imprinted even if [M] is displayed on the LCD panel.
- With an accessory without the lens information contacts such as a helicoid extension tube attached, the exposure data but not the focal length and aperture setting of the lens will be imprinted even if [M] is displayed on the LCD panel.
- Since the exposure data are imprinted on the outside of picture frame, the data will not be seen on the actual photographs.

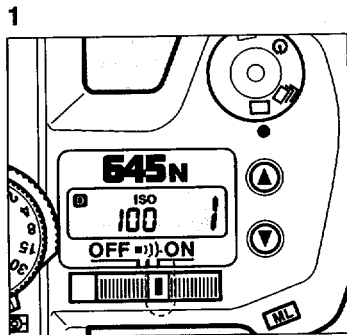

To cancel the Exposure Data Imprint Mode

1. Turn the power ON.

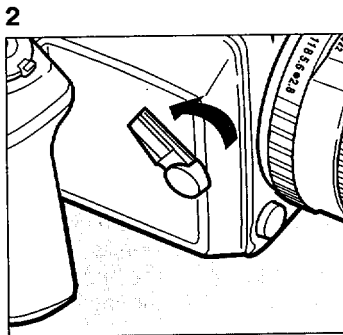

2. Depress the up/down button while holding down the preview lever in the direction of the arrow. [] will be disappeared from the LCD panel.

- To return to the Exposure Data Imprint Mode, repeat the above step and [] will reappear on the LCD panel.

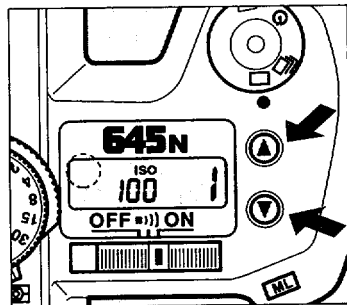

USING A PENTAX DEDICATED EXTERNAL FLASH

Using the TTL Auto Flash

1. Remove the hot shoe cover and attach a Pentax dedicated flash unit.
2. Turn the flash ON.
3. Set the flash to TTL Auto mode.
4. Confirm that the flash is fully charged.
5. Focus on the subject and release the shutter.

Auto Bracketing Exposure Mode with a Pentax TTL dedicated flash

When the Auto Bracketing Exposure Mode is selected with a Pentax dedicated TTL flash in use, only the amount of flash light is varied.

- When the flash is fully charged, the ready lamp on the flash unit lights up. When the shutter release button is depressed halfway down, [] appears in the viewfinder indicating the flash is ready.
- For more details, read the flash operating manual.

Exposure Compensation with a Pentax TTL dedicated flash

When the exposure compensation is set with a Pentax TTL flash in use, it makes possible to adjust the brightness of the subject on the background and the main subject respectively.

AF500FTZ and AF330FTZ

- These flash units feature a built-in infrared spotbeam to assist the autofocus system in dim light and low-contrast conditions.
- The auto zoom function will automatically adjust the angle of discharge according to the lens focal length only when a 645 FA lens is in use.
- The AF500FTZ features a wireless slave-sync flash function.
- The flash effective range appears on the LCD panel only when an a 645 A- lens is in use, or FA lens is in use.
- Multiple flash burst on a single frame is possible with the AF500FTZ.
- In the Programmed AE, Shutter-Priority AE, or Aperture-Priority AE, the TTL Auto Flash Mode will be set automatically even if the flash is set to Manual.
- When the flash is charged and left unused for about 3 minutes, the power automatically switches off to save battery power. Depressing the shutter release button halfway down will restart charging of the flash units.

AF240FT, AF400FTZ

- These flash units feature a built-in infrared spotbeam to assist the autofocus system in dim light and low-contrast conditions.
- In the Programmed AE, Shutter-Priority AE, or Aperture-Priority AE: TTL Auto Flash Mode will be set automatically even if the flash unit is set to Manual.
- When the flash unit is charged and left unused for about 5 minutes, the power will automatically switch off to save battery power. Depressing the shutter release button halfway down will restart charging of the flash unit.

AF200T, AF220T, AF280T, and AF400T

- If the TTL auto mode is selected, these flash units can be used for daylight-sync shooting, because the shutter speed is adjusted according to the ambient brightness. The slower shutter speed varies according to the lens focal length. The shutter speed varies within the shutter speed range of 1/60 of second to a slower speed which does not cause camera shake. However, when a 645 A- lens is in use, the shutter speed is set to 1/60 of second. The aperture value will also be fixed but will vary depending on what ISO film is loaded.



- When using the Three-Level Auto (red, green, and yellow settings) mode, the aperture value is adjusted as shown in the table. When the flash is fully charged, the shutter speed also varies within the shutter speed range of 1/60 to a slower speed which does not cause camera shake. The slowest shutter speed varies according to the lens focal length. When a 645A - lens is use, the shutter speed will be set to 1/60 of second.

	AF200T	AF280T	AF400T
Red	f/2.8	f/4	f/4
Green	f/5.6	f/8	f/8
Yellow			f/11

with ISO 100

Multi-burst flash with the Pentax dedicated flash
 When discharging more than 2 Pentax dedicated flashes, make sure that they are of the same type, combine the Type A with Type B or Type C with Type D. (refer to the overview of Flash Function on page 65).



Overview of Flash Function

CAMERA FUNCTION	TYPE A	TYPE B	TYPE C	TYPE D
After the flash is charged, the camera automatically switches to the flash-sync speed.	○	○	○	○
Automatic aperture setting in the Programmed AE Mode or Shutter-Priority AE mode.	○	○	○*1	○*1
Flash confirmation signal in the viewfinder	○	○		
TTL auto flash	○	○	○*2	
Slow-speed sync in the Shutter-Priority AEMode or Metered Manual Mode	○	○	○	○*3
AF spotbeam	○	○		
Trailing-shutter-curtain sync flash	○	○		
Contrast-control flash mode	○			

TYPE A : AF500FTZ(*4), AF330FTZ

TYPE B : AF400FTZ, AF240FT

TYPE C : AF400T, AF280T, AF220T, AF200T, AF080C,
AF140C, AF200SA

TYPE D : AF200s, AF160, AF140,

Notes:

*1. When using a Type C flash (except AF200SA and AF220T) in the MS (Manual Sync) or M (Manual) modes or when using a Type D flash, set the camera's exposure mode to the Aperture-Priority AE Mode, Manual or Bulb. The Program and Aperture-Priority AE Modes cannot be used because the actual required aperture value may change.

*2. Only the AF200SA flash does not operate.

*3. Only the manual mode can be used.

*4. Multi-burst and slave-sync flash are possible.

Using other type of a flash

Use of non-Pentax flash units may damage the camera.
For the best results, use a Pentax dedicated flash unit.

DAYLIGHT- SYNC SHOOTING



Without Daylight-Sync



With Daylight-Sync

Purpose

In daylight conditions, when a portrait picture is taken with a person's face cast in shadow, discharging the flash will eliminate the shadow.

Daylight-sync photography is obtained in the same manner as normal flash photography, so you simply depress the shutter release button.

- If the background is too bright, it may be overexposed.

SLOW-SPEED-SYNC SHOOTING

67

Purpose

It is possible to balance the exposure of a foreground subject against a dimly-lit background by using the flash to properly expose the foreground subject and a slow-shutter-speed to expose the low light background.

To set

With the Metered Manual Mode set

1. Turn the flash on.
2. Set the camera's exposure mode to the Metered Manual Mode.
3. Select an appropriate shutter speed (slower than 1/60 of second) and aperture combination for a correct exposure.
4. Release the shutter.

To set

With the Shutter-Priority AE Mode set

1. Set the camera's exposure mode to the Shutter-Priority AE Mode.
2. Set the desired shutter speed.
 - If the aperture in the viewfinder blinks, a correct exposure will not be obtained for the background. Adjust the shutter speed until the blinking stops.
3. Turn the flash on.
4. Take the picture.
 - If the power is on before the desired shutter speed is selected, the proper exposure for the background will not be obtained. Be sure to select the shutter speed before the flash is turned on.
 - In the slow-speed-sync shooting, use of a tripod is recommended to prevent camera shake.

USING THE PREVIEW LEVER

1

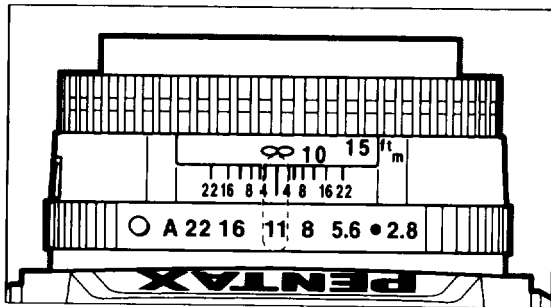

To confirm the depth of field in the viewfinder, depress the preview lever.

1. Turn the lens aperture ring a position other than the [A] position.

2

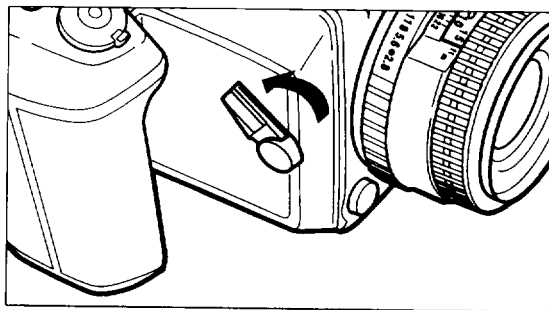

2. Depress the preview lever. The aperture will stop down to the preset value, and the depth-of-field can be confirmed through the viewfinder.

- The lens aperture is closed down while holding the preview lever.
- The shutter cannot be released while depressing the preview lever.
- The depth-of-field cannot be confirmed with the lens aperture set to [A].

ACCESSORIES (OPTIONAL)



A number of dedicated accessories are available for this camera.

- **Cable Switch F**

A shutter release cord designed for use with the 645N, MZ-5/ZX-5, MZ-5N/ZX-5N, MZ-10/ZX-10, MZ-50/ZX-50, Z-1P/PZ-1P, Z-70/PZ-70, Z-1/PZ-1, Z-20/PZ-20, Z-10/PZ-10.

- **Magnifier 645**

A viewfinder accessory for magnifying the central area of the viewfinder.

- **Refconverter A**

Right angle finder which attaches to the grooves on both sides of the viewfinder. The viewfinder magnification can be switched from 1X to 2X.

- **AF500FTZ**

A TTL Auto Zoom flash with a built-in AF spotbeam and large guide number of 50 in meters (ISO 100). It features slave-sync flash function, multiple-flash burst, contrast-control-sync flash, leading/trailing-curtain-sync flash mode.

- **AF330FTZ**

A TTL Auto Zoom flash with a built-in AF spotbeam and guide number of 33 in meters (ISO 100). It features contrast-control-sync flash sync, leading/trailing-curtain-sync flash mode.

- **AF220T**

A TTL Auto flash with the guide number of 22 in meters (ISO 100). It features a bounce-flash capability.

- **Hot Shoe Adapter FG, Extension Cord F5P (L) and Off-Camera-Shoe Adapter.**

The adapters and cord which allow the AF240FT, AF330FTZ, AF400FTZ and AF500FTZ to be used off the camera, while maintaining full electronic coupling to the camera.

- **Macro Flash AF140C**

A TTL macro flash unit with the guide numbers 14 in meters (ISO 100).

- **Filters**

Skylight, Cloudy, UV, Y2, O2, R2, and Circular Polarizing Filter are available. Each filter is available in sizes of 49mm, 52mm, 67mm and 77mm.

- **Remote Battery Pack 645**

The remote battery pack is an accessory to keep batteries warm when photographing in extremely cold temperature.

- **Film back 645**

120 film back and 220 film back are available.

- **AF400T Bracket for 645**

Attaches AF400T flash unit to a 645 camera or 645N camera via tripod socket on the base of camera.

- **Quick Shoe 645/67**

The camera can be attached or removed from the tripod in seconds.

- **Soft Case 645**

Made of soft suede, this can contain a camera with any one of the interchangeable lenses from 45mm to 150mm lens.



- Interchangeable screen

Four types of focusing screens including the standard focusing screen are available. (Please refer to the instruction sheets supplied with each screen for changing instructions.)

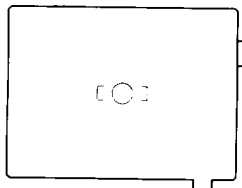

AS-80 (AF Center Spot Matte)

The standard focusing screen for general photography.

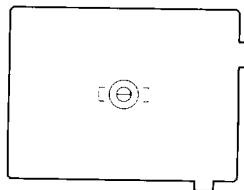

AB-82 (AF Sprit-Image Matte)

Matte screen with the sprit image.

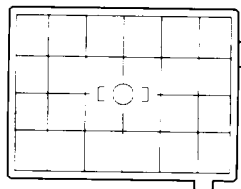

AG-80 (AF Cross-Lined Matte)

Designed to guide picture compositions. The sectional lines for horizontal and vertical are graduated in 9mm.

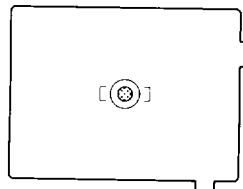

AA-82 (AF Microprism Matte)

For general use, the matte screen with the microprism.

Notes on Accessories

When using an ordinary polarizing filter, a half mirror incorporated into the autofocus system reduces the effectiveness of the autofocus function when used in combination with an ordinary polarizing filter. Use a CIRCULAR POLARIZING FILTER for proper autofocus operation.

- When using the Auto Bellow 645 with 645N camera, the double cable release A is required for releasing the shutter. If your Auto Bellows 645 does not include the double cable release A, the double cable release A is available as an optional accessory.

How to attach

- 1 Attach the double cable release so that the end with the red end ring of the double cable release is connected to the socket with the red ring in the lower part of the front board of the Auto Bellows 645.
- 2 The other end fits into the shutter release button.

Adjust the double cable release so that when the double cable release is pushed with the lens set at the minimum aperture, the shutter is released after the lens is fully stopped down. If the shutter is released before the aperture is stopped fully down to its minimum, adjust the cable so that the end with the red ring to extend further and/or the end that attaches to the shutter button to extend less.

Adjustment procedures

To extend the length, turn the knurled front ring to the left (when viewed from front end), and then turn the back knurled ring to the left (when viewed from front end) while holding the front ring.

To shorten the length, turn the back knurled ring to the right (when viewed from front) , and then turn the front knurled ring to the right while holding the back knurled ring.

INFRARED INDEX

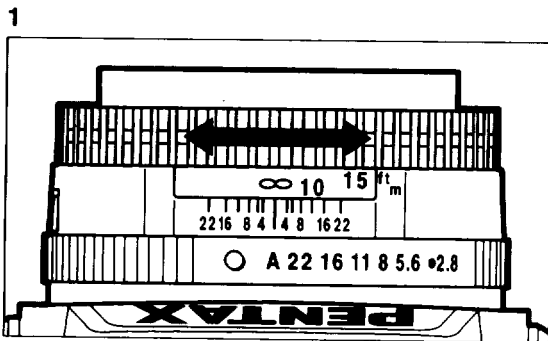

When infrared film and an "R2" or "O2" filter are used, the focal point is different from that of ordinary film exposed in visible light. The autofocus system cannot compensate for this difference automatically.

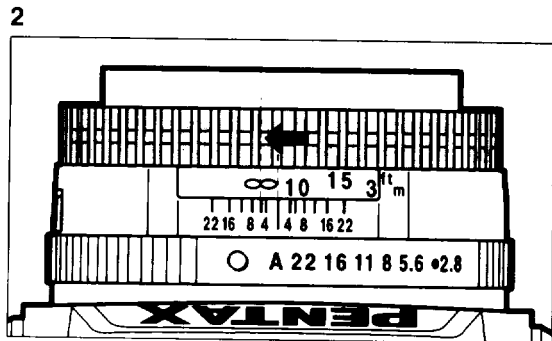

How to focus

1. Focus on a subject as usual.
2. Set the lens to the manual and turn the focusing ring to the left by the distance indicated on the infrared index.

- In the autofocus mode, the focus cannot compensate for infrared photography.
- To set the proper exposure level for infrared pictures, refer to the instructions accompanying the film. The Programmed AE Mode does not give a correct exposure. Use the Metered Manual Mode.

STATEMENT OF FCC COMPLIANCE

This device complies with Part 15 of the FCC Rules. Operation is subject to the following two conditions: (1) This device may not cause harmful interference, and (2) this device must accept any interference received, including interference that may cause undesired operation.

Changes or modifications not approved by the party responsible for compliance could void the user's authority to operate the equipment.

This equipment has been tested and found to comply with the limits for a Class B digital device, pursuant to part 15 of the FCC Rules. These limits are designed to provide reasonable protection against harmful interference in a residential installation. This equipment generates, uses and can radiate radio frequency energy and, if not installed and used in accordance with the instructions, may cause harmful interference to radio communications. However, there is no guarantee that interference will not occur in a particular installation. If this equipment does not cause harmful interference to radio or television reception, which can be determined by turning the equipment off and on, the user is encourage to try to correct the interference by one or more of the following measures:



- Reorient or relocate the receiving antenna.
- Increase the separation between the equipment and receiver.
- Consult the dealer or an experience radio/TV technician for help.

This class B digital apparatus meets all requirements of the Canadian Interference - Causing Equipment Regulations.

Cet appareil numérique de la class B respecte toutes les exigences du Règlement sur le matériel brouilleur du Canada.

TROUBLESHOOTING

What appears troublesome may be easily remedied. Here are some problems that may occur and their remedies. Before contacting a Pentax service center, check the following items.

Symptoms	Causes	Remedies	Reference
The shutter cannot be released.	The last frame is exposed and wound onto the take-up spool.	Remove the film from the film back.	P.21
	The main switch is set to [OFF].	Set the main switch to [ON].	P.10
	The battery warning [] appears.	Replace the battery.	P.8
	The auto bracketing selector is set to [ISO].	Set the auto bracketing selector to the another position.	P.20
	The self-timer mode is being set.	Cancel the self-timer mode.	P.35
The exposure counter does not indicate [!].	The shutter release button is not depressed after loading the film.	Depress the shutter release button after loading the film.	P.18
Indicators do not appear on the LCD panel.	The main switch is the [OFF] position.	Turn the main switch to [ON].	P.10
	No battery has been installed.	Install the batteries.	P.8
	The batteries are improperly installed	Install the batteries properly.	P.8
	The batteries are dead.	Replace the batteries.	P.8
The camera does not focus.	AF frame is not placed over the subject.	Move the camera until the AF frame [] covers the subject.	P.32
	The subject is too close.	Increase the camera-to-subject distance.	P.32
	The focus mode is set to [MF].	Set the lens in the autofocus position.	P.28
	The subject is difficult to autofocus.	Use the focus technique or focus manually using the matte field.	P.55, P.58

Symptoms	Causes	Remedies	Reference
[○] blinks in the viewfinder.	The subject is too close or difficult to autofocus.	Use the focus-lock technique or focus manually using the matte field.	P.55, P.58
[Err] blinks on the LCD panel.	The camera may be defective.	Consult your Pentax distributor or an authorized Pentax repair shop.	

SPECIFICATIONS

- Type:** --- TTL autofocus, auto-exposure 6 x 4.5 format SLR camera
- Format:** --- 56 x 41.5mm
- Usable Film:** 120 roll film (16 exposures) with 120 film holder, 220 roll film (33 exposures) with 220 film holder and 70mm roll film (about 95 exposures) with 70mm film holder
- Usable Film Speed:** --- ISO 12 - 6400
- Exposure Modes:** Programmed AE Mode, Shutter-Priority AE Mode, Aperture-Priority AE Mode, Metered Manual Mode, Bulb Mode, TTL Flash Mode
- Shutter:** Electronically-controlled vertical-run cloth focal-plane shutter, Speed range: (1) Auto 1/1000-30 sec.(stepless), (2) Manual 1/1000-4 sec.(3) Bulb,
- Lens Mount:** Pentax 645 AF mount (645 A-mount with AF coupler, lens information contacts)
- Compatible Lens:** Pentax 645 AF mount, Pentax 645 A-mount
- Autofocus System:** TTL phase-matching multi-(3 points) autofocus system switchable to Spot focusing, AF operational brightness range: EV -1 to 18 (at ISO 100), Focus lock available using shutter release button, Focus Mode: SERVO (predictive AF provided), SINGLE, Manual [MF]
- Viewfinder:** Keplerian telescopic viewfinder with Natural-Bright-Matte focusing screen (Interchangeable focusing screens available), Field of view: 92% vertical and 93% horizontal, Magnification:0.76X(with 75mm lens at infinity), Diopter: -3.5 to +1.5 diopters, 3-point AF frame, Spot AF frame, Spot AF range
- Viewfinder Indication:** Focus Information: In-focus (Green lamp [\circ] is lit), front or back focus signals and unable-to-focus indicator (Green lamp blinks), Shutter speed indication, Aperture indication, Flash ready indication [*] is lit, Bar graph (exposure compensation), Auto bracketing indicator, Over or Under exposure indication in Manual Exposure Mode, [■] exposure compensation indication, [*] memory lock indicator
- External LCD panel Indication:** [Ⓜ] = possible to imprint exposure data, [Ⓛ] =Battery exhaustion warning, Film speed, ISO indication, Film counter
- Self-timer:** --- Electronically-controlled type with delay time of 12 sec. Start by depressing of shutter release button, Operation confirmation: By PCV beep tone. Cancelable after operation
- Mirror:** --- Instant-return mirror with AF secondary mirror



- Film Loading:**———— 120 and 220 films semi-automatically loaded with a start mark, 70mm film automatically loaded
- Film Winding:**———— Auto film winding by built-in motor with single/consecutive mode, Approx.2.0 frames/sec.(consecutive mode)
- Exposure Meter:** —— TTL dual six-segment metering, Metering range from EV2 to EV21 at ISO100 with 75mm f/2.8 lens, Center-weighted and Spot metering mode can be set
- Exposure Compensation:** —— +/-3EV in 0.3EV step increments
- Multiple Exposure:** —— Via Multi-exposure switch
- Auto bracketing:** —— 1/3EV step increments, 2/3EV step increments, 1EV step increments, Possible to use with exposure compensation
- Flash sync:**———— Via Hot shoe with X-sync. contact with couples with Pentax dedicated auto flashes, X-sync speed at 1/60 sec., Slow shutter speed synchronization possible in Metered Manual Mode, X-sync. socket is provided, ISO range=25-800
- Exposure Data Imprinting** —— Possible to imprint the exposure data on the outside of the picture frame. Frame number, exposure mode, shutter speed, aperture value, exposure compensation, metering mode and focal length
- Power Source:** —— Six AA-size 1.5V batteries (Alkaline or Lithium battery), an optional Remote battery pack 645 is attachable with connecting the power cord.
- BatteryExhaustion Warning:** —— Battery exhaustion symbol [⏏] is lit (blinking when the shutter is locked; no indication in the viewfinder.)
- Dimensions and Weight:** —— 147.0mm(W) x 109.0mm(H) x 117mm(D) (5.8"x4.3"x4.6") 1280g (45.2 oz) without batteries.
- Supplied Accessories:** —— Body mount cap 645, Rear body cap 645, Release socket cap F, Strap D, Large eye cap 645, and Hot shoe cover Fc.

SPECIFICATIONS ARE SUBJECT TO CHANGE AT ANY TIME WITHOUT NOTIFICATION OR ANY OBLIGATION ON THE PART OF THE MANUFACTURER.

WARRANTY POLICY

All Pentax cameras purchased through authorized bona fide photographic distribution channels are guaranteed against defects of material or workmanship for a period of twelve months from date of purchase. Service will be rendered, and defective parts will be replaced without cost to you within that period, provided the equipment does not show evidence of impact, sand or liquid damage, mishandling, tampering, battery or chemical corrosion, operation contrary to operating instructions, or modification by an unauthorized repair shop. The manufacturer or its authorized representatives shall not be liable for any repair or alterations except those made with its written consent and shall not be liable for damages from delay or loss of use or from other indirect or consequential damages of any kind, whether caused by defective material or workmanship or otherwise; and it is expressly agreed that the liability of the manufacturer or its representatives under all guarantees or warranties, whether expressed or implied, is strictly limited to the replacement of parts as herein before provided. No refunds will be made on repairs by non-authorized Pentax service facilities.

Procedure During 12-month Warranty Period.

Any Pentax which proves defective during the 12-month warranty period should be returned to the dealer from whom you purchased the equipment or to the manufacturer. If there is no representatives of the manufacturer in your country, send the equipment to the manufacturer, with postage prepaid. In this case, it will take a considerable length of time before the equipment can be returned to you owing to the complicated customs procedures required. If the equipment is covered by warranty, repairs will be made and parts replaced free of charge, and the equipment will be returned to you upon completion of servicing. If the equipment is not covered by warranty, regular charges of the manufacturer or of its representatives will apply. Shipping charges are to be borne by the owner. If your Pentax was purchased outside of the country where you wish to have it serviced during the warranty period, regular handling and servicing fees may be charged by the manufacturer's representatives in that country. Notwithstanding this, your Pentax returned to the manufacturer will be serviced free of charge according to this procedure and warranty policy.

In any case, however, shipping charges and customs clearance fees to be borne by the sender. To prove the date of your purchase when required, please keep the receipt or bills covering the purchase of your equipment for at least a year. Before sending your equipment for servicing, please make sure that you are sending it to the manufacturer's authorized representatives or their approved repair shops, unless you are sending it directly to the manufacturer. Always obtain a quotation for the service charge, and only after you accept the quoted service charge, instruct the service station to proceed with the servicing.

The local warranty policies available from Pentax distributors in some countries can supersede this warranty policy. Therefore, we recommend that you review the warranty card supplied with your product at the time of purchase, or contact the PENTAX distributor in your country for more information and to receive a copy of the warranty policy.



Asahi Optical Co., Ltd. 11-1, Nagata-cho 1-chome, Chiyoda-ku, Tokyo 100-0014, JAPAN (Internet: //www.pentax.co.jp/)

Pentax Europe n.v. Weveldlaan 3-5, 1930 Zaventem, BELGIUM (Internet: //www.pentaxeurope.com/)

Pentax GmbH. Julius-Vosseler-Strasse, 104, D-22527 Hamburg, GERMANY (Internet: //www.pentax.de/)

Pentax U.K. Limited Pentax House, Heron Drive, Langley, Slough Berks SL3 8PN, U.K.

Pentax France S.A. 12/14, rue Jean Poulmarch, 95100 Argenteuil Cedex, FRANCE

Pentax Benelux B.V. (for Netherlands) Spinveld 25, 4815 HR Breda, NETHERLANDS

(for Belgium & Luxemburg) Weveldlaan 3-5, 1930 Zaventem, BELGIUM

Pentax (Schweiz) AG Industriestrasse 2, 8305 Dietlikon, SWITZERLAND

Pentax Scandinavia AB P.O. Box 650, 75127 Uppsala, SWEDEN

Pentax Corporation 35 Inverness Drive East, Englewood, Colorado 80112, U.S.A. (Internet: //www.pentax.com/)

Pentax Canada Inc. 3131 Universal Drive, Mississauga, Ontario L4X 2E5, CANADA



The CE marking assures that this product complies with the requirements of the EC directive for safety.

NAMES OF WORKING PARTS II

- 21 Battery holder release knob
- 22 External power supply socket (p.9)
- 23 Tripod socket (p.31)
- 24 Vertical tripod socket (p.31)
- 25 Multi-exposure switch (p.36)
- 26 X-sync socket
- 27 Strap lug (p.7)
- 28 Film holder (p.15)
- 29 Film holder release knob (p.15)
- 30 Mid-roll wind-up button (p.22)
- 31 Electronic Cable Release socket (p.47)
- 32 Battery holder (p.8)

