

ASAHI
PENTAX

**AUTO BELLOWS
SLIDE COPIER**

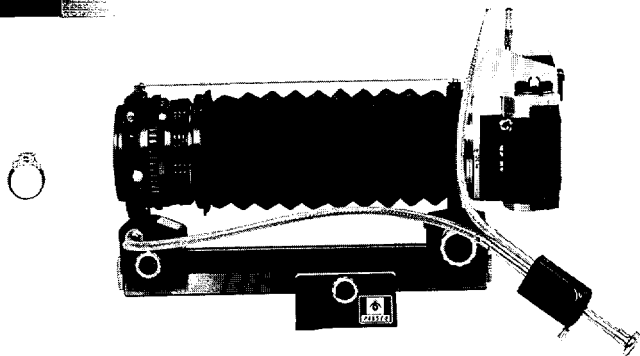

Bellows

Rear Plate

Bellows-to-Camera
Mounting Ring

Clamp Screw

Rear Plate Extension Knob

Rear Plate Clamp Knob
Tripod Position Shift Knob

1

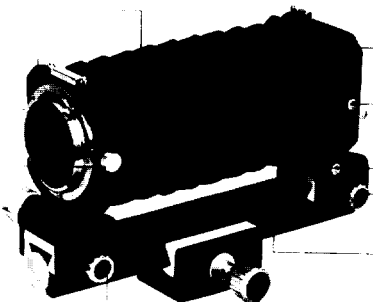

Front Plate

Bellows Clamp Screw

Cable Release Socket
Front Plate Clamp Screw

Gear Rail

Scales

Remote Cable Release



2

2 Slide Copier K

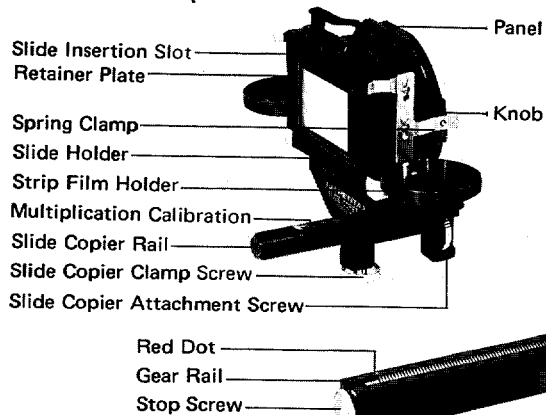

3 Auto Bellows K

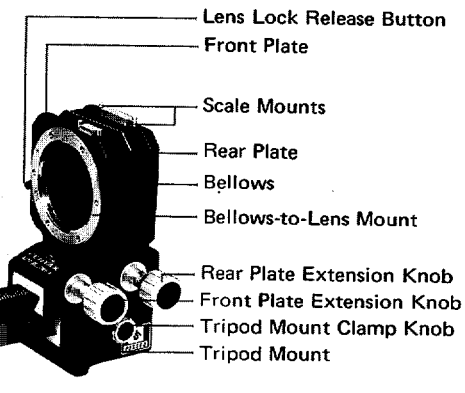

SPECIFICATIONS

Suitable Cameras	Pentax K Series cameras
Suitable Lenses	SMC Pentax-M lenses, and SMC Pentax lenses up to 300mm.
Bellows Extension	NORMAL 38 ~ 170mm. (Lenses mounted in the normal way) REVERSE 56 ~ 176mm. (For 50mm f/1.7 lenses mounted in the reverse direction)
Automatic Diaphragm	Automatic diaphragm closed by double cable release.
Size	Width 97 x height 131.5 x length 207mm (Auto Bellows only) Width 158 x height 135 x length 298mm (With Slide Copier)
Weight	792g. (Auto Bellows only. Scales and double cable release included) 256g. (Slide Copier only)
Accessories	Double cable release, scales (for both 50mm and 55mm lenses)

FEATURES

The Asahi Pentax Auto Bellows K used with an Asahi Pentax K Series camera and any of the SMC Pentax lenses is all you need to be ready for a wide range of photography, from close-up work to macrophotography. And with the addition of either the normal or the automatic K extension rings, a complete range from the closest of close-up work with all lenses, right up to macrophotography is possible.

The lenses can also be attached to the front plate in reverse, so there is no need for the reverse adaptor K-52mm or K-49mm. It is also equipped with diaphragm automation, operated by the double cable release.

Moreover, together with the Slide Copier, you can also reproduce slides and film strips.

HOW TO OPERATE THE AUTO BELLOWS K UNIT

WITH THE LENS UNREVERSED

Fig. 4 Loosen the clamp screw (2) on the right side of the rear plate (1), and remove the bellows-to-camera mounting ring (3).

Fig. 5 Remove the lens from the Pentax camera, and attach the bellows-to-camera mounting ring (3) to the lens mount (4) of the camera in place of the lens.

Fig. 6 Now connect the camera to the bellows unit by attaching the bellows-to-camera mounting ring (3) to the rear plate (1) of the bellows. If the camera is to be used in the horizontal position, align the upper edge of the rear plate (1) with the front edge of the pentaprism housing of the camera, and tighten the clamp screw (2).

4

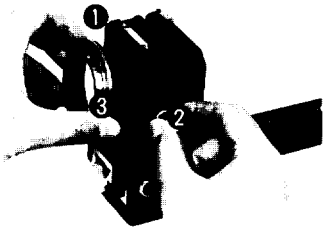

5

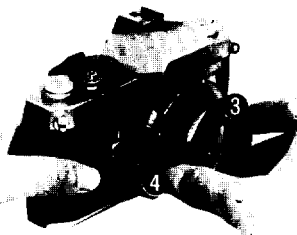

6

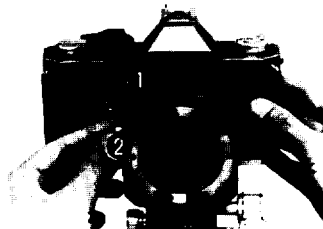

Fig. 7 If the camera is to be used in the vertical position, however, rotate the camera so that the shutter release button is on the operator's right hand side. Align the side edge of the camera with the upper edge of the rear plate (1), and then tighten the clamp screw (2).

7

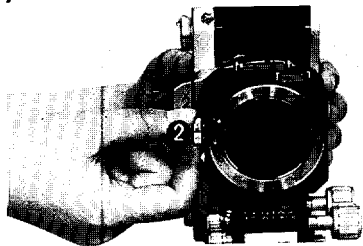
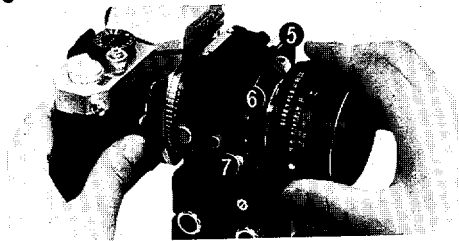

Fig. 8 Attach the lens to the bellows-to-lens mounting ring (6) located on the front plate (5). To remove the lens again, depress the lens lock button (7), and turn the lens 65° counterclockwise. Note that this lock button does not operate in the same way as the lens lock release lever on Pentax K Series cameras.

8



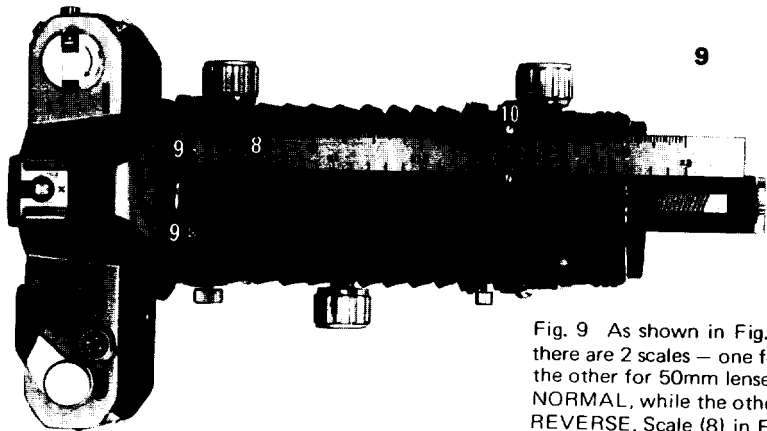
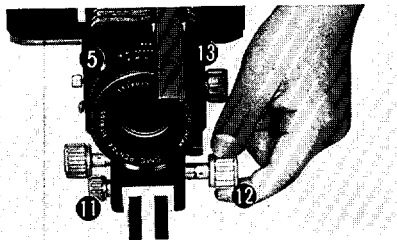

Fig. 9 As shown in Fig. 1 on page 2, there are 2 scales — one for 55mm lenses, and the other for 50mm lenses. One side is marked NORMAL, while the other is marked REVERSE. Scale (8) in Fig. 9 shows the

NORMAL side, and it is mounted on the two pins (9) at the upper side of the rear plate, the scale being kept in position by magnets. The extension (length) of the bellows is indicated on the top of the front plate (10). The magnification scale along the opposite edge of the extension scale is only for use with the slide copier.

Fig. 10 Loosen the front plate clamp screw (11)

10



and turn the front plate extension knob (12) to adjust the extension of the bellows (13). After focusing, always remember to retighten the front plate clamp screw (11).

Fig. 11 The bellows can also be adjusted by loosening the rear plate clamp screw (14) and turning the rear plate extension knob (15). Again, remember to retighten the clamp screw (14) after focusing.

11

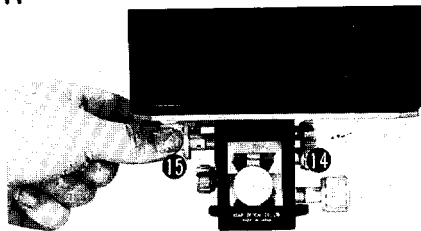
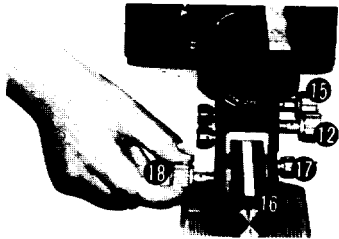

Fig. 12 The tripod mount (16) can be freely moved up and down the gear rail by turning the tripod position shift knob (18) after the tripod mount clamp knob (17) has been released. In other words, the Auto Bellows K assembly can be moved back and forth when mounted on a tripod. But the clamp knob must always be retightened again. This is a relatively simple operation, especially if you remember that the

12



shift knob (18) is located on your right side (when looking from behind), while the front extension (12) and rear extension knobs are located on your left. Fig. 13 The end of one of the cables of the double cable release (19) has a red ring. Screw this cable into the cable release socket (20) located below the front plate. (At this time, be careful not to force the socket in.) Screw the other cable into the shutter release button (21) of your Pentax camera.

13

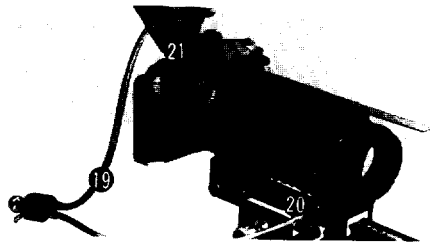

HOW TO OPERATE THE AUTO BELLOWS K UNIT

Fig. 14 First check the action of the automatic diaphragm. While looking through the front of the lens, press button (22) of the double cable release. The diaphragm should operate before the shutter. Because of the slight delay between these two actions, the auto bellows unit is not suitable for rapidly moving subjects. Note that if the double

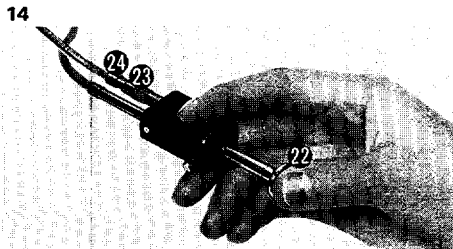

cable release is not inserted (or simply forgotten), the diaphragm will remain open.

Double Cable Release Check

Since a shutter release occurring before diaphragm closure will result in overexposure, test the double cable release by the following method. Screw the cable with the red ringed tip into the cable release socket as before, and set the diaphragm to the smallest aperture opening (f/22 for standard lenses, and f/32 for macro lenses). Do not screw in the other cable at this stage. Depress the double cable release button (22) as shown in Fig. 14. The diaphragm will close down to its minimal aperture. Make a note of this aperture position.

Now screw the other cable into the shutter release button as before and depress the double cable release button once again. Check whether the shutter releases after the diaphragm has closed down to its minimal aperture. If by chance, the shutter releases before the diaphragm reached its minimal aperture, loosen screw (23) in Fig. 14. Turn (24) in a clockwise direction, and (23) in a counterclockwise direction. This reduces the amount of projection from the cable for the shutter release, thus delaying the shutter release time. But be careful not to delay it too much.

Fig. 15 For T (time) exposure, set the shutter speed to B. While keeping the double cable release depressed (shutter remains open), tighten the locking screw (25). This enables you to make exposures of 10, 20 or more seconds. To close the shutter, simply release the locking screw (25).

15

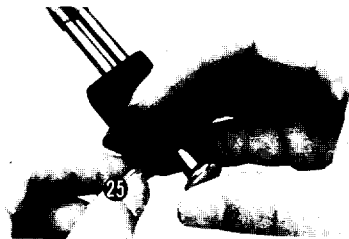

MOUNTING TO A TRIPOD

Fig. 16 Now the auto bellows assembly is ready to be mounted on a sturdy tripod which should be at least 3.5 kg in weight, and have very firm interlocking parts.

16

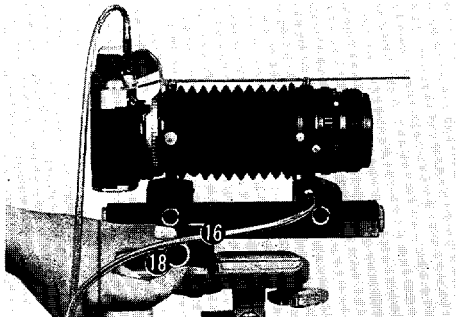

The assembly should be positioned with the lens side a little on the heavy side. Adjust the position of the tripod mount by turning the shift knob (18). Although mounting the assembly at its center of gravity would appear to be more stable, it can in fact often result in camera movement. A camera-heavy situation is definitely undesirable.

HOW TO ASSEMBLE THE AUTO BELLOWS K UNIT FOR REVERSE

Reversed lens photography is only for magnifications of greater than 1X.

Fig. 17 Undo the stop screw (27) from the end of the gear rail (26).

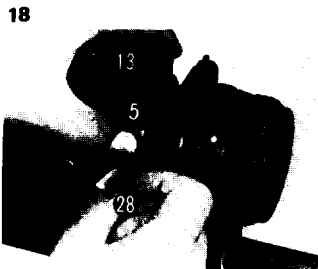
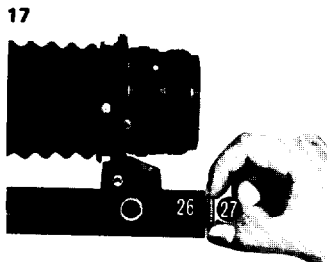

Fig. 18 Loosen the bellows clamp screw (28), and separate the bellows (13) from the front plate (5).

Fig. 19 Loosen the front plate clamp knob (11) and remove the lens and front plate from the gear rail.

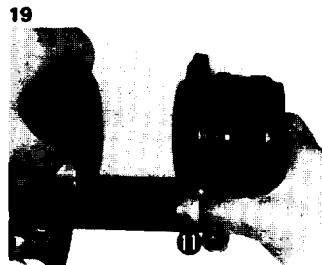

Fig. 20 When using a 49mm filter size lens, reverse the front plate (5) and then remove the adaptor (29) by rotating it counterclockwise.

Fig. 21 Screw the adaptor (29) into the front frame of the lens.

Fig. 22 Turn the lens and front frame in the reverse direction, and reinsert onto the gear rail (25).

20



21

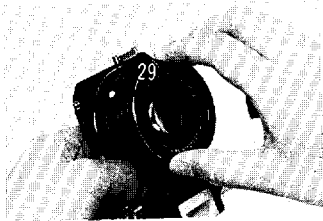

22

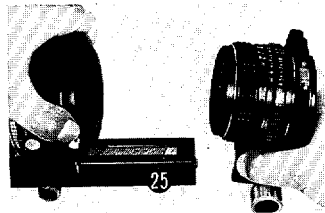

Fig. 23 Attach the front of the bellows (13) to the front frame of the lens, tighten the bellows clamp screw (27). 52mm threads are found inside the ring (30) at the rear side of the front panel (30). This ring is used for attaching a 52mm screw-in filter, 52mm lens hood, etc.

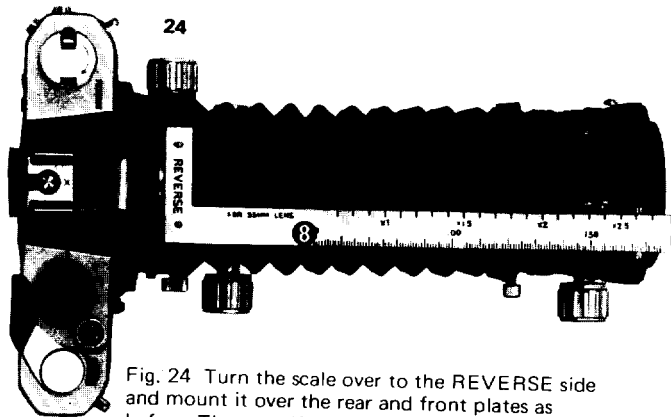
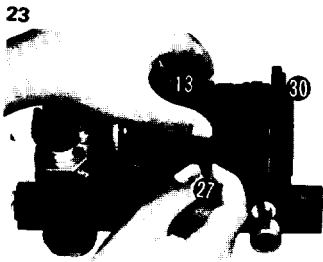
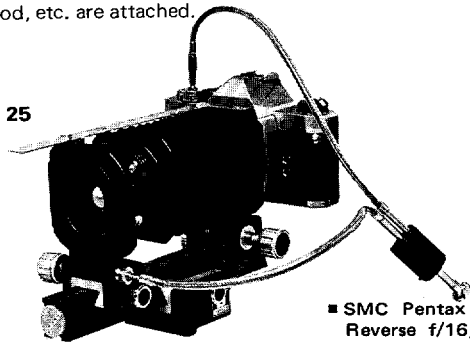

Fig. 24 Turn the scale over to the REVERSE side and mount it over the rear and front plates as before. The magnification calibration along the opposite edge is the same magnification for use with the slide copier as explained before.

Fig. 25 The double cable release is attached in the way as for NORMAL, and the same sturdy tripod shown in Fig. 16 can be used. The screw-in filter, lens hood, etc. are attached.



"Marigold"

■ SMC Pentax 35mm, f/3.5,
Reverse f/16, Neo-Pan film.
Auto Bellows K, bellows length 173mm,
magnification 5.2x. "Aurobo"
Automatic flash, synchronized cord
for distance adjustment.



FOCUSING

The diaphragm remains open no matter what aperture is selected. So it is possible to focus in the same way as any ordinary Pentax camera.

To focus the camera, move either the front plate (12) or rear plate (15) extension knobs or the shift knob (18), while looking through the viewfinder (31). What focusing method should be used depends on magnifications. When magnification is low, use the front plate extension knob. At higher magnifications, the the cross micropism and split image become dark, making focusing difficult. So the area around the dark region has to be used for focusing.

At higher magnifications, adjustment on the lens barrel will usually not give you a sharp picture. Remember that when you use the Auto Bellows K unit, the distance and depth of field scales on the lens barrel cannot be used.

26



27

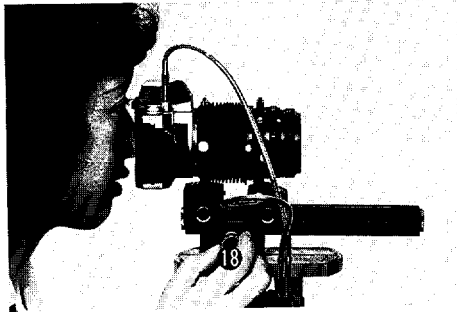

Depth of Field

The closer the lens is to the subject, the shallower the depth of field becomes. Even for minimum apertures of $f/22$ for standard lenses and $f/32$ for SMC Pentax Macro 50 and 100mm lenses, you may still not be able to get the desired depth of field. Therefore, be very careful in your focusing.

For close-ups, the focus plane lies right in the center of the depth of field. So in Fig. 28, the best focusing of the area between the closest and farthest limits of the depth of field is achieved by focusing for a position exactly mid-way between the two planes.

28

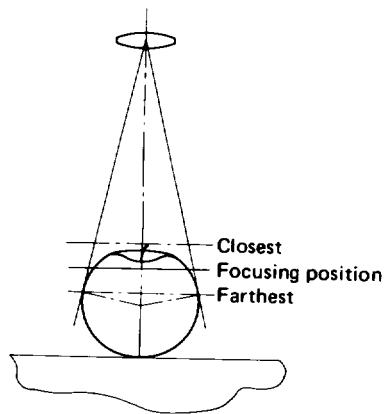

Exposure

The automatic diaphragm is operated by the double cable release with the exposure being measured when the diaphragm closes down. If Pentax K2 or ME is set to AUTOMATIC, and the double cable release used to first close the diaphragm down and then release the shutter, the exposure will still be measured automatically, but no stray light should be allowed to enter via the viewfinder. If you need to take your eye away from the viewfinder, cover it with the viewfinder cap. Manual exposure measurements with Pentax MX, K2, KX or KM must be made in the stopped-down mode. To stop down (close) the diaphragm, push in and rotate clockwise either of the knurled rings shown in the illustration, (32) or (33). After adjusting the camera for proper exposure by

rotating the shutter speed dial and aperture ring, release the shutter by pushing in the plunger of the double cable release (illus. 14, p. 11). The diaphragm can be reopened at anytime by rotating the knurled ring counterclockwise.

29

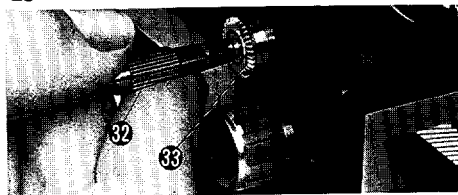

Outside the Exposure Meter Range

When the subject is too dark and the exposure lies outside the metering range at the particular aperture you wish to use, first open the diaphragm until a reading can be made. For example, if you want to use $f/11$, but the best possible reading is $f/4$ at 1 sec., increase the shutter speed by the same number of stops as the diaphragm is closed down to the desired aperture. That is, $f/4$ to $f/11$ is 3 stops, so increase the speed by 3 stops also — from 1 sec. to 8 secs.

F	1.4	2	2.8	4	5.6	8	11	16	22	32
Exposure Time (sec)	1/2	1	2	4	8	16	32	64	128	256

Irregularities in Color Films

For time exposures of over 1 sec. (and especially over 10 sec.) with color film, certain irregularities in film response leads to underexposure. So exposure times have to be increased. Particularly with most reversible color films, changes occur in the color reproduction if the exposure times exceed 1/10 sec. (and especially .1 sec.). This can be avoided by using CC filters (color compensation). Refer to Kodak's Color Data Guide for information on Kodak color films.

Larger Than Life Size

When the lens-to-film distance of any lens is twice the focal length of the lens, as shown Fig. 30-2 the photographic magnification will be 1x (life size). The bellows of the Auto Bellows K unit can be extended from 38mm to 170mm (the distance from the bellows-to-lens mount to the plane where the bellows-to-camera mounting ring meets the lens mount of the camera). So any lens of focal length under 150mm can be used to photograph larger than life.

Fig. 30 refers to the Macro 50mm lens. The lens has been designed for focusing with "a" larger than "b" which is the case for ordinary photography (Fig. 30-1). So it is only natural that optimum sharpness when

photographing larger than life, as in Fig. 30-3, is achieved with the lens reversed. The close-up tables between pages 33 and 51 have been roughly divided into those for up to life size (pp. 33 ~41) and those for larger than life (pp. 43 ~ 51).

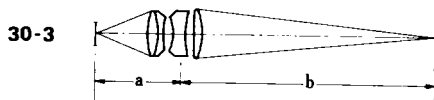
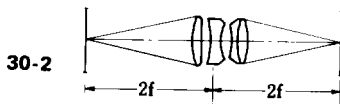
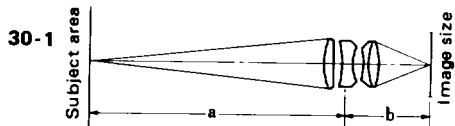

Aperture Not Shown in the Pentax MX & KX Viewfinders

The aperture numbers of most SMC lenses can normally be seen along the top edge inside the viewfinder of Pentax MX and KX cameras. But when the belows units is used, the lens is too far away and the numbers can no longer be seen.

Using the Screw-Mount Takumar Lenses
Takumar screw-mount lenses can be attached to the Auto Bellows K unit with the aid of the mount adaptor K, shown in Fig. 31.

Fig. 32 First screw the mount adaptor into the rear of the Takumar screw-mount lens. Line up the red dot (34) on the adaptor with the red dot (35) on the bellows-to-lens mount. Insert the lens and rotate it clockwise 65° to lock it into position.

The lens and mount adaptor are removed from the bellows unit in the same way as with the Pentax K Series cameras.
Focusing and exposure measurements are also the same as for ordinary cameras.

31



32

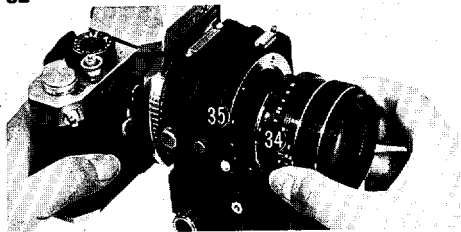

HOW TO USE THE CLOSE-UP TABLES

1. Area to be photographed
2. Lens
3. Picture area of film

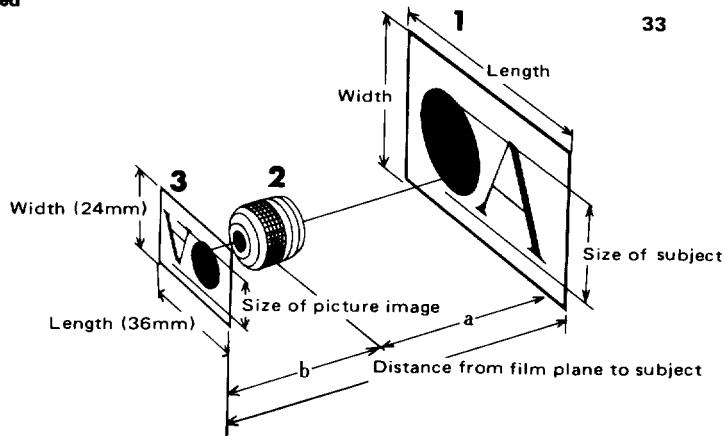

Magnification

$$\text{Magnification} = \frac{\text{Size of image}}{\text{Size of subject}} \text{ or}$$

$$\frac{\text{Height/ length of picture area}}{\text{Height/ length of subject}}$$

The size of the picture area for Pentax K series cameras is 24mm x 36mm. Therefore, magnification can be expressed as

$$\frac{24\text{mm}}{\text{Height of area to be photographed}} \text{ or}$$
$$\frac{36\text{mm}}{\text{Length of area to be photographed}}$$

Area to be Photographed

Is the subject area (measured as height x length) which completely fills the picture area on the film.

Exposure Factors

The Pentax K Series cameras have a built-in through-the-lens exposure meter which measures the amount of light actually passing through the lens. Therefore, these exposure factors will not be required. But bear in mind that close-up work requires longer exposure times than when photographing subjects of the same brightness from normal distances.

How to Read the Close-Up Tables

These tables may be used in three different ways, depending on whether you start with the magnification, picture area, or the film-to-subject distance.

Film-to-Subject Distance

The Pentax K Series cameras have no markings to show the exact position of the

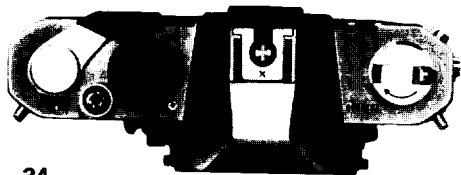

34

28

film plane, but the rear edge of the pentaprism housing (see Fig. 34) is almost in the same plane as the film. The desired distance is first determined from the close-up tables, and then the scales are used to measure the distance between the subject and the rear edge of the pentaprism more precisely.

When Starting with Magnification

When you want to photograph a subject of a certain size so that the image will be a particular size on the film, start by determining the magnification.

For example, if you want to take a photograph of a subject 40mm in size so that its size on the film will be 32mm, when using a 50mm f/1.7 lens, the magnification will be $32/40 = 0.8$. Table

1 shows that the bellows in this case should be extended to somewhere in between 40 and 50mm. To find the exact extension, use the following simple formulae:

$$m = \frac{f}{a - f} \quad \text{and} \quad b = \frac{af}{a - f}$$

where m = magnification
 a = distance from the subject to the first nodal point (shown in Fig. 32 on page 28)
 b = distance from film to second nodal point.
and f = real focal length of the lens.
 $b - f$ is the required bellows extension.
Measure this distance with the scales (shown in Fig. 9 page 8 and Fig. 24 on page 16) when adjusting the position of the front plate. Focus

by turning the tripod position shift knob as in Fig. 27 on page 19. Be careful not to touch the rear plate extension knob, since this may alter the bellows extension and the magnification. Depending on the lens, the real focal length f , may differ slightly from the quoted focal length. See your local Pentax dealer or Service Center for further details.

When Starting With Picture Area

When you want to photograph a particular subject area, first measure the size of the area. For example, if you want a subject measuring 30 x 45mm to completely fill the picture area of the film when using a 50mm $f/1.7$ lens, Table 1 shows that the bellows extension will have to be about 40 to 50mm. Again, use the scales to adjust the bellows position, and the tripod

position shift knob for the focusing. If small changes in the size of the area to be photographed are permissible, focusing may also be achieved by shifting the camera and tripod back and forth a little, or the subject itself may be moved. Even adjustments to the rear plate (by turning the rear plate extension knob) are possible.

The minimum magnification obtained when using a 200mm lens with the Auto Bellows K unit is 0.19 (Table 10); and 0.13 (Table 11) when using a 300mm lens. Consequently, the front plate will hardly ever be used for focusing purposes.

Moreover, remember that ordinary focusing (with the Focusing Ring of the lens) is rarely adopted when using bellows units.

When Starting With the Film-to-Subject Distance

When the subject cannot be approached too closely, first measure the distance to the subject. For example, if you would like a magnification of 0.2x when more than 1.5m distant from the subject, you will find by checking through the different tables, that this can only be achieved by using a 200mm lens (Table 10), or a 300mm lens (Table 11).

Focusing Problems and Aperture

In general, focusing becomes rather difficult when you approach magnifications of 1x when using any of the faster lenses, or the single lens reflex wide-angle lenses of shorter focal length, or telephoto lenses whose lens barrel lengths are relatively short in comparison with their focal lengths.

And where the lens is reversed for magnifications of over 1x, the same focusing problem will be encountered as the magnification approaches 1x. Lenses not included in the tables have been omitted because they are not suitable for close-up work with the Auto Bellows K unit. The 50mm f/1.2 and the 50mm f/1.4 lenses are more suitable for photographing three dimensional subjects where sharp focusing in all four corners is not necessary. The 50mm f/1.4 lens can only be used for photographing subjects in flat planes if the small apertures (f/11 and f/16) are employed. On the other hand, if the aperture is set at stops smaller than f/11 in ordinary photography, sharpness deteriorates due to diffraction. When the 50mm f/1.4 and f/1.2 lenses are set to f/16 or beyond for magnifications of 1x and less in NORMAL, or 1x and more in REVERSE,

the sharpness will deteriorate somewhat due to diffraction, but the improvement due to loss of peripheral aberration is greater. The close-up tables 1, 2, and 19-21 (standard lenses) also list the apertures which will still give satisfactory sharpness over the complete picture area when photographing subjects in a flat plane.

Lenses Best for Close-Ups

The SMC Pentax Macro 50mm f/4 and 100mm f/4 lenses are designed for maximum performance at magnifications of 1/5 ~ 1/10x. Hence they are particularly suitable for close-up work requiring critical focusing. Distortion (a kind of aberration where straight lines do not come out as straight lines in the photograph) has been reduced to a minimum. So the macro lenses are very good for close-up work requiring highly accurate dimensions.

CLOSE-UP TABLES (use of Lenses in Normal Position)

SPECIAL NOTES

1. The wide-angle lenses up to 35mm and the 40mm f/2.8 lens are excluded from the close-up tables. For such wide-angle lenses with short focal length and high-speed lenses are not suited for close-up work of high magnification, unless they are used in reverse.

The extension of the Auto Bellows K is 38mm or more. Therefore, if a wide-angle lens, 35mm or less, is used with the bellows, the magnification exceeds 1x. The lens should be reversed at such a time.

The 40mm f/2.8 lens, which provides a magnification of about 1x, should be used with the Auto Extension Tube K for close-up work.

2. Also excluded from the close-up tables are fast lenses such as the 50mm f/1.2 and 50mm f/1.4, which provide a magnification of about 1x and have unsatisfactory sharpness for flat subjects.

3. Magnification for the normal position has only been listed up to a little over 1x. For greater magnification, use the lens in reverse.

4. The SMC Pentax Macro 50mm f/4 lens can attain magnification of 1x by employing the Auto Extension Tube K No. 3, while the Macro 100mm f/4 attains magnification of over 1x with the Auto Extension Tubes No. 1, 2 and 3 (in combination). Diaphragm automation and full-aperture metering are also retained. The use of the extension tubes is highly recommended.

NOTES: •• The optimum aperture for subjects in a flat plane is f/11 or smaller.
 ••• The optimum aperture for subjects in a flat plane is f/8 or smaller.

Table 1: 50mm f/1.7(Distance scale set to ∞)

Magnification	Bellows Extension	Area to be Photographed	Film-Plane-to-Subject Distance	Exposure Factor
0.73	38 mm	33×50 mm	209 mm	× 2.8
0.77 ***	40	31×47	208	× 3.0
0.96 **	50	25×37	204	× 3.6
1.15 **	60	21×31	205	× 4.3

Table 2: 55mm f/1.8(Distance scale set to ∞)

Magnification	Bellows Extension	Area to be Photographed	Film-Plane-to-Subject Distance	Exposure Factor
0.67	38 mm	35.9×53.8 mm	233 mm	× 2.7
0.70	40	34.1×51.1	230	× 2.8
0.88 ***	50	27.3×40.9	224	× 3.4
1.06 **	60	22.7×34.1	223	× 4.1

Table 3: 85mm f/1.8(Distance scale set to ∞)

Magnification	Bellows Extension	Area to be Photographed	Film-Plane-to-Subject Distance	Exposure Factor
0.45	38 mm	53.8 × 80.7 mm	378 mm	× 2.3
0.59	50	40.9 × 61.4	345	× 2.9
0.82	70	29.2 × 43.8	323	× 3.9
1.06	90	22.7 × 34.1	320	× 5.1

Table 4: SMC PENTAX-M 100mm f/2.8(Distance scale set to ∞)

Magnification	Bellows Extension	Area to be Photographed	Film-Plane-to-Subject Distance	Exposure Factor
0.38	38 mm	63 × 95 mm	499 mm	× 2.4
0.50	50	48 × 72	448	× 3.0
0.70	70	34 × 51	411	× 4.0
0.90	90	27 × 40	399	× 5.3
1.10	110	22 × 33	398	× 6.7

Table 5: 105mm f/2.8(Distance scale set to ∞)

Magnification	Bellows Extension	Area to be Photographed	Film-Plane-to-Subject Distance	Exposure Factor
0.36	38 mm	66.3 × 99.5 mm	548 mm	× 2.4
0.48	50	50.4 × 75.6	491	× 2.9
0.67	70	36.0 × 54.0	448	× 4.0
0.86	90	28.0 × 42.0	433	× 5.2
1.05	110	22.9 × 34.4	431	× 6.6

Table 6: 120mm f/2.8(Distance scale set to ∞)

Magnification	Bellows Extension	Area to be Photographed	Film-Plane-to-Subject Distance	Exposure Factor
0.32	38 mm	75.8 × 113.7 mm	669 mm	× 2.3
0.42	50	57.6 × 86.4	590	× 2.8
0.58	70	41.1 × 61.7	528	× 3.8
0.75	90	32.0 × 48.0	502	× 5.0
0.92	110	26.2 × 39.3	493	× 6.3

Table 7: 135mm f/2.5 and f/3.5 (Figures in brackets for f/3.5 lens) (Distance scale set to ∞)

Magnification	Bellows Extension	Area to be Photographed	Film-Plane-to-Subject Distance	Exposure Factor	
				f/2.5	f/3.5
0.28	38 mm	84.9 × 127.3 (85.3 × 127.9) mm	801 (795) mm	× 2.2	× 2.1
0.37	50	64.5 × 96.7 (64.8 × 97.2)	699 (692)	× 2.7	× 2.5
0.45	60	53.7 × 80.6 (54 × 81)	649 (641)	× 3.1	× 2.9
0.52	70	46.1 × 69.1 (46.3 × 69.4)	616 (607)	× 3.6	× 3.4
0.59	80	40.3 × 60.5 (40.5 × 60.8)	594 (585)	× 4.1	× 3.8
0.67	90	35.8 × 53.7 (36 × 54)	579 (570)	× 4.6	× 4.3
0.74	100	32.2 × 48.4 (32.4 × 48.6)	569 (559)	× 5.2	× 4.8
0.82	110	29.3 × 44.0 (29.5 × 44.2)	562 (553)	× 5.8	× 5.3
0.97	130	24.8 × 37.2 (24.9 × 37.4)	557 (547)	× 7.1	× 6.5
1.04	140	23.0 × 34.5 (23.1 × 34.7)	557 (547)	× 7.8	× 7.1

Table 8: SMC PENTAX-M135mm f/3.5(Distance scale set to ∞)

Magnification	Bellows Extension	Area to be Photographed	Film-Plane-to-Subject Distance	Exposure Factor
0.28	38 mm	85 × 128 mm	845 mm	× 2.4
0.37	50	65 × 97	742	× 3.0
0.44	60	54 × 81	691	× 3.5
0.52	70	46 × 69	657	× 4.1
0.59	80	40 × 60	635	× 4.7
0.67	90	36 × 54	620	× 5.4
0.74	100	32 × 48	609	× 6.1
0.82	110	29 × 44	603	× 6.9
0.96	130	25 × 37	597	× 8.5
1.04	140	23 × 34	597	× 9.4

Table 9: 150mm f/4(Distance scale set to ∞)

Magnification	Bellows Extension	Area to be Photographed	Film-Plane-to-Subject Distance	Exposure Factor
0.25	38 mm	94.7 × 142.1 mm	983 mm	× 2.3
0.33	50	72.0 × 108.0	853	× 2.8
0.40	60	60 × 90	788	× 3.3
0.47	70	51.4 × 77.1	745	× 3.8
0.53	80	45.0 × 67.5	714	× 4.4
0.60	90	40 × 60	693	× 5.0
0.73	110	32.7 × 49.1	668	× 6.3
0.87	130	27.7 × 41.5	656	× 7.7
1.00	150	24. × 36	653	× 9.3
1.07	160	22.5 × 33.8	654	× 10.2

Table 10: 200mm f/4(Distance scale set to ∞)

Magnification	Bellows Extension	Area to be Photographed	Film-Plane-to-Subject Distance	Exposure Factor
0.19	38 mm	126.3×189.5 mm	1561 mm	×2.0
0.25	50	96 ×144	1321	×2.4
0.30	60	80 ×120	1197	×2.8
0.35	70	68.6×102.9	1112	×3.2
0.40	80	60 × 90	1051	×3.6
0.45	90	53.3× 80.0	1005	×4.0
0.55	110	43.6× 65.5	944	×5.0
0.65	130	36.9× 55.4	908	×6.0
0.75	150	32 × 48	887	×7.2
0.85	170	28.2× 42.4	876	×8.4

Table 11: 300mm f/4(Distance scale set to ∞)

Magnification	Bellows Extension	Area to be Photographed	Film-Plane-to-Subject Distance	Exposure Factor
0.13	38 mm	182.9 × 274.4 mm	3141 mm	× 2.0
0.17	50	139.0 × 208.6	2623	× 2.3
0.21	60	115.9 × 173.8	2354	× 2.7
0.24	70	99.3 × 149.0	2164	× 3.0
0.28	80	86.9 × 130.3	2024	× 3.4
0.31	90	77.2 × 115.9	1918	× 3.8
0.38	110	63.2 × 94.8	1768	× 4.7
0.45	130	53.5 × 80.2	1671	× 5.6
0.52	150	46.3 × 69.5	1605	× 6.7
0.59	170	40.9 × 61.3	1559	× 7.8

Table 12: Bellows 100mm f/4

Magnification	Bellows Extension	Area to be Photographed	Film-Plane-to-Subject Distance	Exposure Factor
0.02	40 mm	1198 × 1797 mm	5187 mm	×1.0
0.12	50	199.7 × 299.5	1044	×1.3
0.22	60	108.9 × 163.4	676	×1.6
0.32	70	74.9 × 112.3	545	×1.9
0.42	80	57.1 × 85.6	481	×2.2
0.52	90	46.1 × 69.1	445	×2.6
0.72	110	33.3 × 49.9	412	×3.4
0.92	130	26 × 39	402	×4.3
1.12	150	21.4 × 32.1	402	×5.3
1.32	170	18.2 × 27.2	409	×6.4

USE OF LENSES IN REVERSE POSITION

1. When the lens is reversed on Auto Bellows K, the bellows extends 170mm or more. It is, therefore, very useful for close-up work to reverse standard lenses and retro-focus wide-angle lenses. When reversed, the 55mm lens provides magnification up to 2.7x and the 28mm lens, up to 6.2x.
2. On the other hand, reversing the lens is not useful for telephoto lenses. When reversed, the 85mm lens provides magnification of 0.3x to 1.35x, and is excluded from the close-up tables.
3. The Macro 100mm lens or any other lens with a longer focal length cannot provide magnification of 1x even with the maximum bellows extension. It is meaningless to reverse such lenses for close-up work, and they are therefore excluded from the close-up tables.

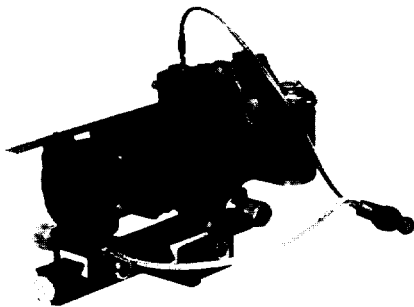

Table 13: 28mm f/2.8(Distance scale set to ∞)

Magnification	Bellows Extension	Area to be Photographed	Film-Plane-to-Subject Distance	Exposure Factor
2.61	56 mm	9.1 × 13.7 mm	158 mm	× 10.2
5.22	130	4.5 × 6.8	226	× 33.6
5.92	150	4.0 × 6.0	246	× 42.3
6.63	170	3.6 × 5.4	265	× 51.9

Table 14: 28mm f/3.5(Distance scale set to ∞)

Magnification	Bellows Extension	Area to be Photographed	Film-Plane-to-Subject Distance	Exposure Factor
2.66	70 mm	9.0 × 13.5 mm	172 mm	× 10.8
3.36	90	7.1 × 10.7	189	× 15.9
4.07	110	5.9 × 8.9	208	× 22.0
5.12	130	5.0 × 7.5	227	× 29.1
5.47	150	4.4 × 6.6	246	× 37.2
6.18	170	3.9 × 5.8	266	× 46.3

Table 15: 30mm f/2.8(Distance scale set to ∞)

Magnification	Bellows Extension	Area to be Photographed	Film-Plane-to-Subject Distance	Exposure Factor
2.57	63 mm	9.3 × 14.0 mm	166 mm	× 9.8
2.80	70	8.5 × 12.8	172	× 11.3
3.47	90	6.9 × 10.3	190	× 16.2
4.13	110	5.8 × 8.7	208	× 21.9
4.79	130	5.0 × 7.5	227	× 28.6
5.45	150	4.4 × 6.6	247	× 36.1
6.11	170	3.9 × 5.9	266	× 44.5

Table 16: 35mm f/2.8(Distance scale set to ∞)

Magnification	Bellows Extension	Area to be Photographed	Film-Plane-to-Subject Distance	Exposure Factor
1.90	62 mm	12.6×18.9 mm	171 mm	× 6.6
2.12	70	11.3×16.9	177	× 7.9
2.41	80	10.0×14.9	186	× 9.6
2.70	90	8.9×13.4	194	×11.4
2.98	100	8.0×12.1	203	×13.4
3.27	110	7.3×11.0	212	×15.6
3.84	130	6.2× 9.3	230	×20.5
4.41	150	5.4× 8.1	249	×26.0
4.98	170	4.8× 7.2	268	×32.1

Table 17: 35mm f/3.5(Distance scale set to ∞)

Magnification	Bellows Extension	Area to be Photographed	Film-Plane-to-Subject Distance	Exposure Factor
2.01	58 mm	12.0 × 18.0 mm	166 mm	× 7.6
2.34	70	10.2 × 15.4	176	× 9.6
2.63	80	9.1 × 13.7	184	× 11.5
2.92	90	8.2 × 12.4	193	× 13.5
3.20	100	7.5 × 11.2	202	× 15.7
3.49	110	6.9 × 10.3	211	× 18.1
4.06	130	5.9 × 8.9	230	× 23.2
4.63	150	5.2 × 7.8	248	× 29.1
5.20	170	4.6 × 6.9	268	× 35.6

Table 18: 40mm f/2.8

(Distance scale set to ∞)

Magnification	Bellows Extension	Area to be Photographed	Film-Plane-to-Subject Distance	Exposure Factor
1.32	45 mm	20.0×30.0 mm	170 mm	× 4.1
1.34	50	18.0×27.0	172	× 4.6
1.58	60	15.0×23.0	177	× 5.7
1.82	70	13.0×20.0	184	× 6.9
2.06	80	11.6×17.4	191	× 8.2
2.30	90	10.4×15.6	199	× 9.7
2.78	110	8.6×12.9	216	×12.9
3.27	130	7.3×11.0	233	×16.6
3.75	150	6.4× 9.6	252	×20.8
4.23	170	5.7× 8.5	271	×25.4

Table 19: SMC PENTAX-M50mm f/1.4, 50mm f/1.4

(Distance scale set to ∞)

Magnification	Bellows Extension	Area to be Photographed	Film-Plane-to-Subject Distance	Exposure Factor
1.10	(M) 60 mm	21.7 × 32.6 mm	197 mm	× 3.3
1.18	64	20.3 × 30.5	198	× 3.6
1.30	70	18.5 × 27.7	200	× 4.1
1.50	80	16.0 × 24.0	205	× 4.9
1.69	90	14.2 × 21.3	211	× 5.9
1.89	100	12.7 × 19.1	218	× 6.8
2.09	110	11.5 × 17.3	225	× 7.9
2.48	130	9.7 × 14.5	242	× 10.3
2.87	150	8.4 × 12.5	259	× 12.9
3.26	170	7.4 × 11.0	276	× 15.9

NOTES:

- * The optimum aperture for subjects in a flat plane is f/16 or smaller.
- ** The optimum aperture for subjects in a flat plane is f/11 or smaller.
- ***The optimum aperture for subjects in a flat plane is f/8 or smaller.

Table 20: 50mm f/1.7

(Distance scale set to ∞)

Magnification	Bellows Extension	Area to be Photographed	Film-Plane-to-Subject Distance	Exposure Factor
0.90 **	56 mm	26.6×39.9 mm	205 mm	× 3.4
1.17 **	70	20.5×30.7	205	× 4.5
1.36 ***	80	17.6×26.4	209	× 5.3
1.56	90	15.4×23.1	214	× 6.2
1.75	100	13.7×20.6	221	× 7.2
1.94	110	12.3×18.5	228	× 8.3
2.32	130	10.3×15.5	243	× 10.7
2.71	150	8.8×13.3	260	× 13.3
3.09	170	7.7×11.6	278	× 16.3

NOTES:

- * The optimum aperture for subjects in a flat plane is f/16 or smaller.
- ** The optimum aperture for subjects in a flat plane is f/11 or smaller.
- *** The optimum aperture for subjects in a flat plane is f/8 or smaller.

Table 21: 55mm f/1.8

(Distance scale set to ∞)

Magnification	Bellows Extension	Area to be Photographed	Film-Plane-to-Subject Distance	Exposure Factor
1.08 **	80 mm	22.2 × 33.3 mm	224 mm	× 4.2
1.26 ***	90	19.1 × 28.7	226	× 5.0
1.61	110	14.9 × 22.4	236	× 6.6
1.96	130	12.2 × 18.4	250	× 8.6
2.31	150	10.4 × 15.6	266	× 10.8
2.67	170	9.0 × 13.5	282	× 13.2

Table 22: Macro 50mm f/4(Distance scale set to ∞)

Magnification	Bellows Extension	Area to be Photographed	Film-Plane-to-Subject Distance	Exposure Factor
1.23	77 mm	19.5×29.2 mm	210 mm	× 5.3
1.49	90	16.2×24.2	216	× 6.5
1.87	110	12.8×19.2	229	× 8.7
2.26	130	10.6×15.9	244	×11.1
2.65	150	9.1×12.5	261	×13.9
3.04	170	7.9×11.9	278	×16.9

HOW TO ASSEMBLE AND OPERATE SLIDE COPIER K

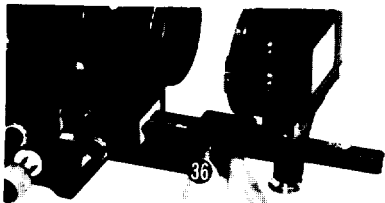

- 1** Fig. 1 Remove the stop screw from the end of the gear rail (as shown in Fig. 17 on page 14). Attach the slide copier, inserting and then tightening the slide copier screw (36) into the end of the rail.

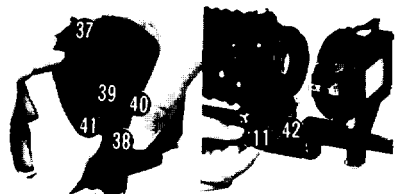

- 2-3** Fig. 2 When using a 49mm filter size lens, remove the panel (37) of Slide Copier K from the spring clamp (38), hold the slide copier at the two grips (40) on both sides of the lens mounting ring with thumb and forefinger, remove the adaptor (41) (the same adaptor as used for the reverse position) and screw it into the front frame of lens. In the case of a 52mm filter size lens, remove the adaptor but do not attach it to the lens. In either case, the grips (40) should be attached to the lens mounting ring (39).

Fig. 3 For the 50mm f/1.4 lens, extend the front plate right up to Slide Copier K, and then tighten the front plate clamp knob (11). For the 55mm f/1.7 and macro

50mm lenses, extend the front plate up to the red dot shown in Fig. 3, and then tighten the front plate clamp knob (11).

Set the distance scale to ∞ for the 50mm f/1.4 and 55mm lenses, but to around 0.7m for the 50mm f/1.7 and the macro 50mm lenses.

Fig. 4 Release the spring clamps (38) from the panel (37) of the Slide Copier K. Hold the slide copier at the two grips (40) on both sides of the lens mounting ring with thumb and forefinger as shown, and mount it into the front of the lens. Lens hoods are attached in the same way.

Fig. 5 Insert the slide to be copied into the slide insertion slot (44) of the slide holder (43). This slide holder can be moved up and down several millimeters to facilitate trimming of the slide when magnifying by more than 1x. The center position is indicated by a click stop, and this is the normal position giving 1x magnification.

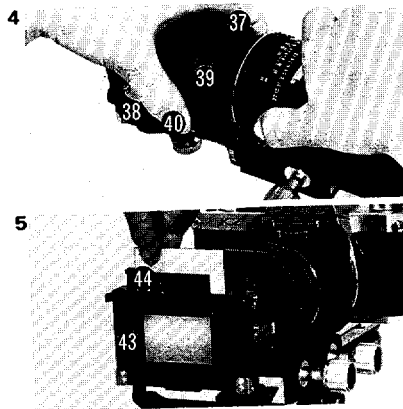

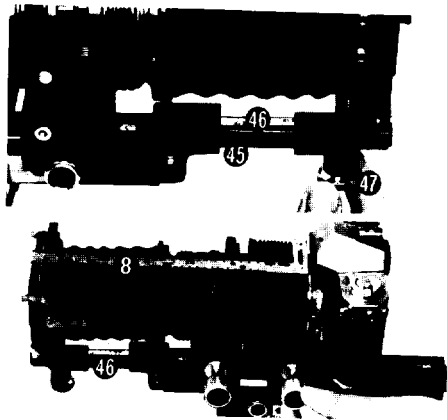

- 6 Fig. 6 The magnification calibrations (46) marked on the slide copier rail (45) are for use with the 50mm and 55mm lenses. Magnifications of 1x, 1.1x, 1.2x, 1.3x, 1.4x, and 1.5x are selected by operating the slide copier clamp screw. The calibration for the macro 50mm lens coincides with the other 50mm lens at the 1x position.
- 7 Fig. 7 Most copying is done at the 1x position, so the scales (8) mounted on top of the Auto Bellows K unit is set to NORMAL. Match the magnification calibration on the scales (8) with the magnification calibration (46) on the Slide Copier K rail. The 50mm lens calibration however, is not suited for the macro 50mm lens.

Reverse

Fig. 8 When you want to "crop" the slide while making the copy, increase the magnification. 1.5x will crop the slide by 2/3. However, for magnifications of more than 1.2x, use the lens in reverse. Reverse the lens in the same way as described on pages 14 ~ 17. (Fig. 17 ~ 25), setting the assembly up as shown in Fig. 8. The lens mounting ring (39) of the slide copier is mounted into the rear of the front plate (5) in the same way as it is mounted into the front of the lens. But remember to turn the scales over to REVERSE.

For the macro 50mm lens, the front plate is extended up to the front edge and clamped into place just like the other 50mm lenses. The distance scale too is set to ∞ . However,

the bellows cannot be retracted to magnifications any lower than about 1.2x. All reverse positions differ from the normal positions, so the magnification calibration on the rail (46) (see Fig. 7) cannot be used.

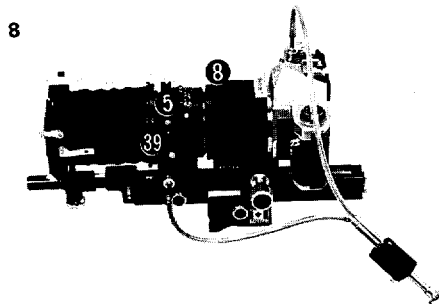

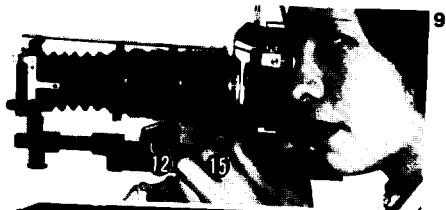

Focusing

Fig. 9 Adjust the focus by rotating the rear plate extension knob (15) while looking through the viewfinder. The lens position must remain fixed, so the front plate extension knob (12) should not be adjusted at this stage under any circumstances at all.

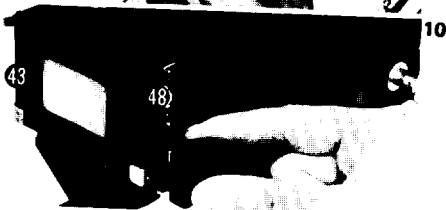

Copying Film Strips

Fig. 10 When the film to be copied is strip film, align the two openings in the strip film holder arm (48) with the pins found on the slide holder (43), and push down.

Fig. 11 Open the retainer plate (49) (which includes the ground glass window) attached to the slide holder (43), and carefully insert the strip film. Close the retainer plate again.

Fig. 12 Wind both ends of the strip film around the strip film holders (48) to prevent any damage to the film surface. The strip film is unloaded by opening up the retainer plate and pushing the strip film holders upwards. Focusing is adjusted as before, by turning the rear plate extension knob. The strip film however, lies in a plane about 3mm further away than ordinary slides. So the position on the magnification calibration (46) (see Fig. 6) will have to be moved by the same amount towards the lens.

11

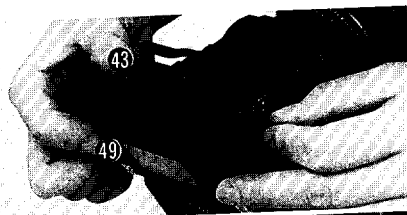

12

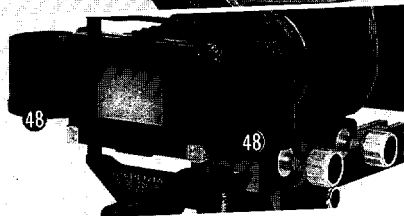

HOW TO USE SLIDE COPIER K

Illumination

1. During the day, the simplest method is to face the equipment towards the sky. But on very fine days, the blue sky will tend to tint the copies a shade of blue. For reversible color film, the shutter speed should be shorter than 1/10 sec. (1/1000 - 1/25 sec.) due to the irregularities referred to earlier on page 22. This should be relatively simple when facing the sun. However, note that color slides tend to "curl" if exposed to the sun for too long. Another point to remember is that the sun striking the ground glass window at an angle may cause shadows of the the slide holder retaining plate (49) to appear if the angle of the retaining plate exceeds 45 degrees.

2. At night, use a 500W color photographic floodlight (reflector lamp). The brightness varies greatly with distance, but distances not requiring a shutter speed longer than 1/10 sec. are preferable.

13

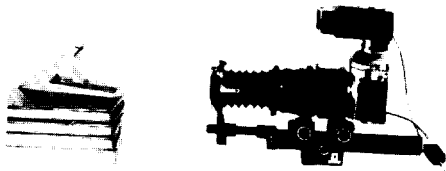

3. Automatic flash "Autorobo" (see Fig. 13) may also be employed. Reflect the light from a convex mirror at about 18cm from the ground glass plate. Use ASA 100 reversible color film and apertures of $f/11 \sim f/16$. The height and angle of the mirror are important factors. The Pentax exposure meter cannot be used, but always set the "AUTOROBO" automatic flash to M (manual). Nor are the guide numbers of any help, but with experience, correct exposure will be obtained.

Due to the reasons described under "Focusing Problems and Aperture" on page 30, the following apertures are recommended. $f/11$ for 50mm $f/1.7$ or 55mm $f/1.8$ lenses, and $f/16$ or $f/22$ for 50mm $f/1.4$ lenses.

For Macro 50mm $f/4$ lenses, $f/4$ may be used, but only if the surface of the slide is absolutely flat. The surfaces of most slides however, tend to bulge somewhat at the center, so $f/5.6$ gives better results.

Exposure

Should be the same as that for the Auto Bellows K unit. However, in the K2 and KX cameras at a magnification of 1x, the shutter speed values in the viewfinder are hidden, and only the indicator needle can be seen.



ASAHI OPTICAL CO., LTD. C.P.O. 895, Tokyo 100-91, JAPAN

ASAHI OPTICAL EUROPE N.V. Weveldlaan 3-5, 1930 Zaventem, BELGIUM

ASAHI OPTICAL EUROPE N.V. (Deutschland-Niederlassung) 2000 Hamburg 54 (Lokstedt), Grandweg 64, WEST GERMANY

ASAHI OPTICAL BRASILEIRA IND. E COM. LTDA. Rua Estados Unidos, 1053, São Paulo-SP, BRASIL

PENTAX CORPORATION 5501 South Broadway, Littleton, Colorado 80120, U.S.A.

06961

Printed in Japan