

# PENTAX

# IR REMOTE CONTROL SYSTEM

(Transmitter/Receiver)

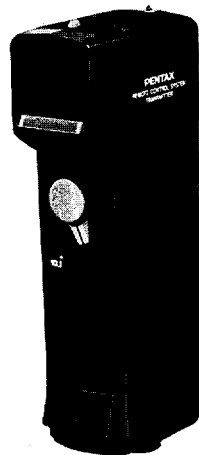
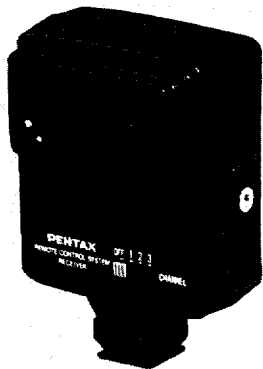

The Pentax Infrared Remote Control System is a unit which permits an almost unlimited possibility of special photographic assignments through a cordless remote control principle. It is comprised of a transmitter and a receiver. The transmitter emits a pulse of near-infrared ray which then is received by the receiver unit to simultaneously operate the camera mechanism, motor drive, a winder, or a flash. The system is able to wirelessly control the operations cited from a maximum distance of 60m in a straight path; a three-channel control provision allows the simultaneous or independent operation of three cameras, with the addition of three infrared pulse receiving units.

To assure the maximum utilization of the system, it is recommended that this manual be read and thoroughly understood prior to the actual operation of the unit itself.

## CONTENTS

---

Description of parts .....	2
Battery (for the transmitter) .....	4
Battery (for the receiver) .....	5
Battery check (Transmitter and receiver) .....	6
Battery precautions .....	7
Mounting unit on the camera.....	8
Kinds of cords .....	9
Proper connecting of the cords .....	10
Infrared remote control.....	12
Channel selection .....	13
Single and consecutive operation .....	14
Optional shoe bracket .....	16
Cordless multi-flash photography .....	18
Specifications .....	20
General precautions concerning proper care of system .....	21

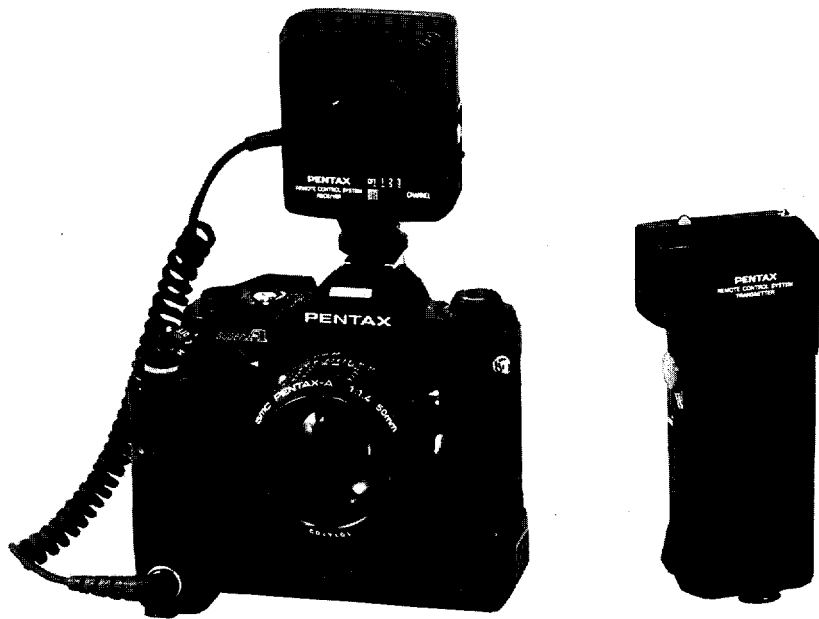

## DESCRIPTION OF PARTS

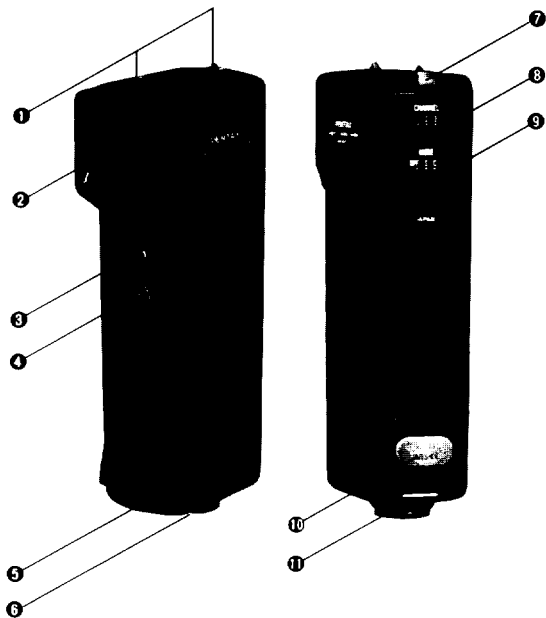

### Transmitter

- ① Sight
- ② Flash window
- ③ Trigger button
- ④ Trigger lock lever
- ⑤ Battery chamber
- ⑥ Hotshoe
- ⑦ Pilot lamp
- ⑧ Channel switch
- ⑨ C/S switch
- ⑩ Hotshoe lock button
- ⑪ Strap retainer

(Fix the strap as in the drawing.)

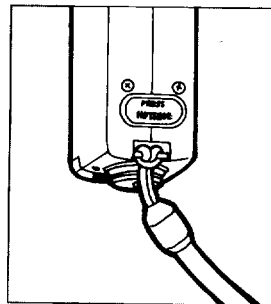

## Receiver

- ① Light receiving window
- ② Confirmation lamp
- ③ Power/channel switch
- ④ Fastening ring
- ⑤ Cold shoe (360° rotatable, with click stop at every 30°)
- ⑥ Remote release cord socket
- ⑦ Remote synch cord socket
- ⑧ Battery chamber
- ⑨ Battery chamber lock lever
- ⑩ Tripod socket

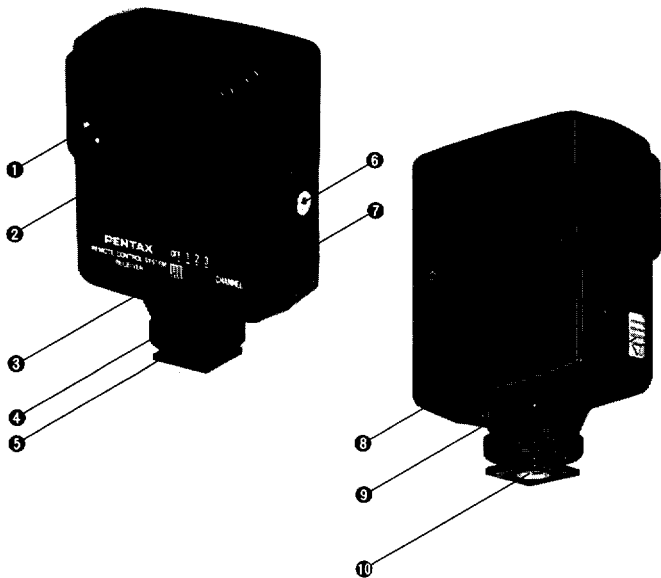

## BATTERY (for the transmitter)

1



2

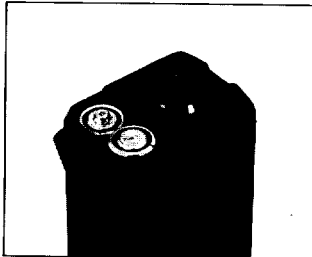

3



Use two AA size batteries mentioned below.

Manganese batteries SUM-3

Alkaline manganese batteries LR-6

Ni-Cd rechargeable batteries (You need  
a battery charger.) KR-AA

1. Slide the battery chamber cover to the direction of the arrow mark to open the cover, while depressing.
2. Insert two AA size batteries into the battery chamber in accordance with the +/- markings and close the cover.

## BATTERIES (for the receiver)

1

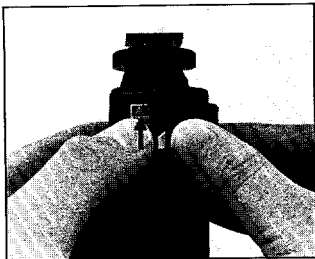

2

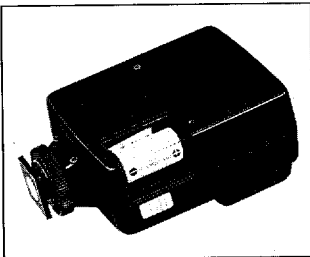

3

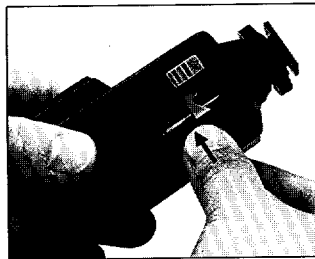

Use one battery mentioned below.

Alkaline-manganese battery 4LR44

Lithium battery 2CR-1/3

Silver oxide battery 4SR44 (4G13) recommended  
for low temperature weather condition.

1. Slide the lock lever of the battery chamber cover to the direction of the arrow mark to open the cover.

2. Insert the battery into the battery chamber in accordance with the +/- markings and close the cover.

## BATTERY CHECK

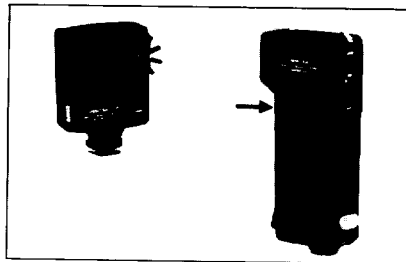
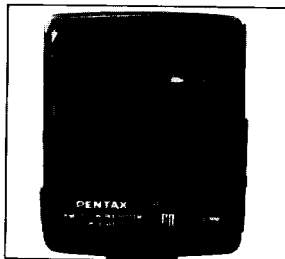
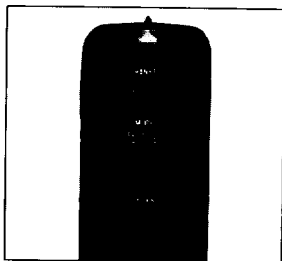

### Transmitter

Adjust Power/C.S switch to either the "S" (Single) or "C" (Consecutive) position, as the situation may require; the power source will automatically turn ON, and the pilot lamp will be lit. In the event the pilot lamp does not light, reconfirm that the batteries have been inserted in proper sequence of polarity (+ & -). Batteries should be replaced whenever two seconds or more are required before the pilot lamp is lit, for it indicates battery depletion.

### Receiver

Whenever the channel switch is positioned to 1, 2, or 3, the power source will be turned ON; only the

OFF position will turn the power off.

Battery check may be conducted in the following manner; set the same channel indication upon the transmitter and the receiving unit, while adjusting the C-S switch (transmitter) to "C". Confirm that the pilot lamp is lit, then direct the flash window to face the light receiving window of the receiver as indicated in the photograph and depress the trigger button. Keep depressing and the receiver confirmation lamp will keep lighting. Releasing finger pressure upon the trigger button will halt lighting, indicating that the battery condition is satisfactory.

Following battery check, do not fail to turn the unit OFF.



## BATTERY PRECAUTIONS

- When inserting batteries, make sure that polarities are properly aligned. Wrong polarity alignment may cause unexpected damages to your equipment.
- Replace all the batteries at the same time. Do not mix battery brands, types or old batteries with new ones.
- Remove batteries when not using your equipment for a long time. Batteries tend to leak if left too long in your equipment and may cause serious damages.
- Never throw used batteries into fire since it may explode, causing unexpected damages to you.
- Store batteries in a cool place, and out of reach of children.
- Batteries are very sensitive to cold and performance tends to deteriorate at temperatures near freezing point. Performance is restored as soon as batteries are brought back to room temperature. Keep a set of batteries warm in your pocket when shooting in freezing weather to substitute when the others no longer perform well.

AA batteries for the transmitter

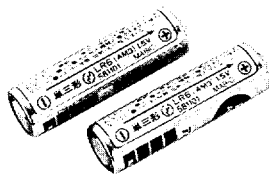

4G13 battery for the receiver



## MOUNTING UNIT ON THE CAMERA

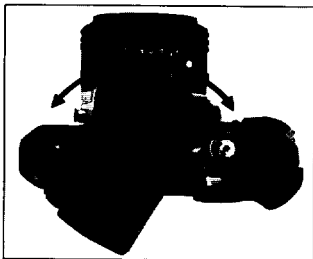

### Receiver

Slide the receiver shoe into the hotshoe located on the camera; tighten fastening ring in direction of the arrow to affix securely. The receiver may be rotated within a  $360^\circ$  circular direction with click stops at  $30^\circ$  as may be observed in the photograph. Adjust light receiving window of the receiver to face the direction of signal transmission. Receiver removal from the camera may be executed by merely loosening the fastening ring.

### Transmitter

Insert transmitter the shoe completely into the hotshoe of the camera while depressing the hotshoe lock release button. Removal of finger pressure upon the lock release button will affix the unit securely. The transmitter is rotatable, and may thus be directed to face the receiving unit to absorb the emitted signal. To remove the transmitter, again depress the hotshoe lock release button, and pull out gently — it will slide out easily.

## KINDS OF CORDS

1. Infrared remote release cord 2p

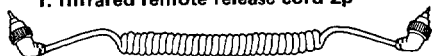

2. Infrared remote release cord 3p



3. Infrared remote release power cord 4p

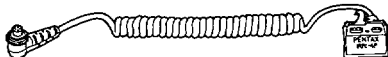

4. Infrared remote release power cord 5p



Cord Numbers	Camera & Accessories
1	Super A
2	Winder LX, Winder MEII
3	Motor drive LX
4	Motor drive A

★ It is recommended to use new batteries for the above winders and motor drive units since low battery capacity may cause malfunctions.

★ Motor drive MX not usable.

★ All these cords are optional items, so that you will please separately obtain according to your purposes.

## PROPER CONNECTING OF THE EXCLUSIVE CORDS

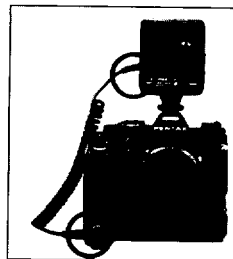
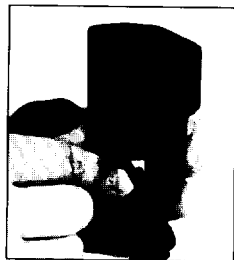
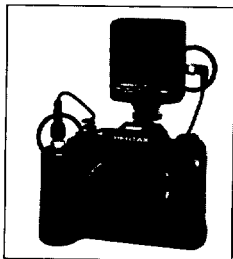
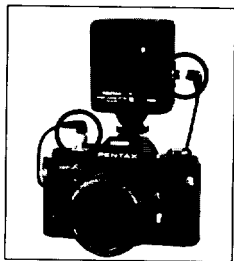

In the event a camera equipped with an electromagnetic shutter release is utilized with this Remote Control System, the infrared remote release cord (2P) is employed. One end of the cord should be connected to the remote release cord socket found on the receiver, and the other, to the camera's shutter button cable connector.

Remote control operation is also possible with a motor drive in conjunction with the camera for rapid sequence photography.

The infrared remote release cord 3P is used to connect the release cord socket of the receiver with the remote control socket of the winder. When the infrared remote release power cords 4P and 5P are used, the receiver's power is supplied from motor drive batteries. So take away the battery cover and put the cord plug in the same manner as closing the battery cover. The other end is inserted into the remote control socket of the motor drive or winder and is fastened by the screw.

● Super A

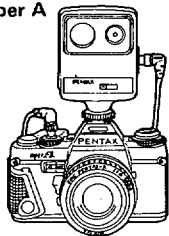

● Motor drive A

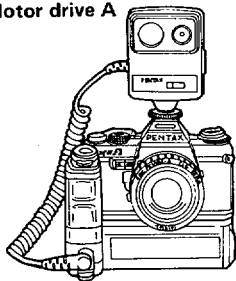

● Winder ME II

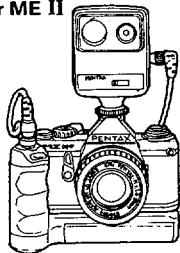

● Winder LX

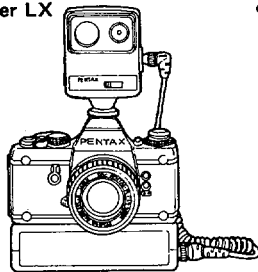

● Motor drive LX

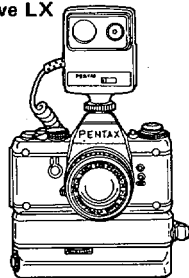

## INFRARED REMOTE CONTROL

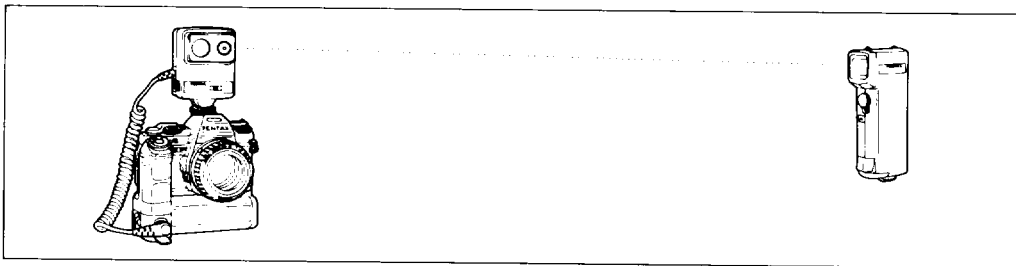

### Remote control photography

The normal operable distance between the transmitter and receiver during infrared remote control is a maximum of approximately 60m, provided that they are positioned to face one another in a straight path without interference. The distance, however, may become shorter according to certain weather conditions — for example, haze or a somewhat dusty situation; also, when sunlight falls upon the light receiving window of the receiver unit.

Under certain indoor conditions, the system may trigger even though the transmitter-receiving units are not aligned with one another, due to signal being reflected off the surrounding buildings or walls. At times, the system may be activated due to the strong light emitted from certain sources, such as a high voltage fluorescent or mercury vapor lamp. Malfunctions can be minimized or eliminated by operating the system prior to the actual shooting to confirm that it is functioning properly and is not being affected by conditions cited earlier.

## CHANNEL SELECTION

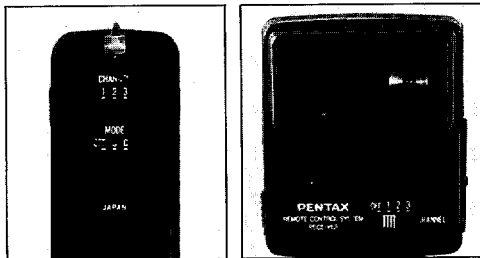

When the normal combination of a transmitter-receiver is utilized, the respective channel switches on both units should be set at the identical channel designations.

★ When a combination of two or three receivers are utilized as illustrated (top right) and channel switches of the respective receivers are set to different designations, the cameras involved (2 or 3) may be controlled individually through a single transmitter.

★ As illustrated (lower right) multiple cameras may be simultaneously controlled within the prescribed range (of simultaneous signal receiving), should the channel switches of the respective receivers be positioned at the same designation.

- Individual remote controls of three cameras

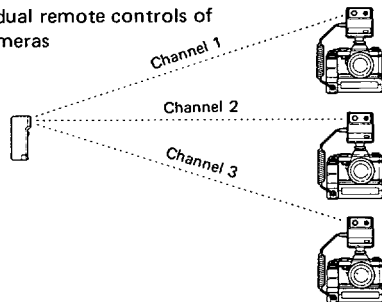

- Simultaneous remote controls of multiple cameras

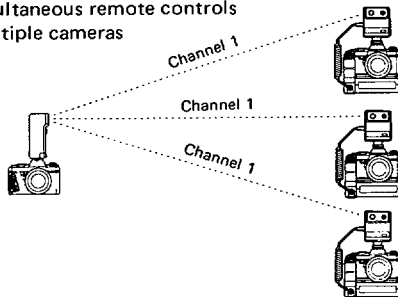

## SINGLE AND CONSECUTIVE OPERATION

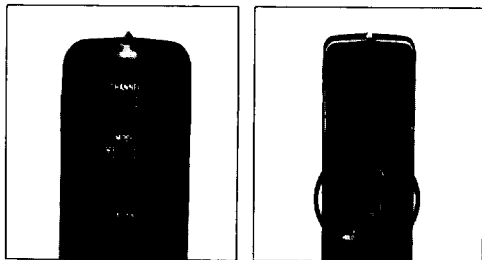

Adjust the C.S. switch of the motor drive or winder unit to either C or H.L (Motor Drive A). Then single or consecutive shooting can be selected by the setting of the Power/C.S switch of the transmitter. "S" indicates single exposure, while the "C" marking, consecutive exposures. To start signal transmission, confirm that the pilot lamp is lit, then depress the trigger button.

### Single-frame exposure

Set trigger lock lever to position indicated in the illustration, and depress the trigger button to commence operation. When film winding is

completed, the single frame remote control operation will automatically cease. To indicate that the signal has been properly received, the confirmation lamp will be lit once on the receiver.

### Consecutive exposures

Consecutive exposures are possible by holding down the trigger button (first signal); releasing finger pressure upon the trigger button (second signal) will halt the transmitter operation, after the film is wound. Finger pressure must be released only after the pilot lamp has been lit. For a long sequence of exposures in a continuous manner, set the trigger lock lever to "Hold" position; the depressed trigger will then be locked into position, permitting consecutive exposures. Return the trigger lock lever to the original position (next to "Hold") to stop foregoing repeat sequence (see above photo). During consecutive exposures, the receiver confirmation lamp will be successively lit.

\* Releasing finger pressure on the trigger button in consecutive exposure mode before the pilot lamp has been lit, may cause malfunctions and may not stop consecutive exposure operation. In that case, turn off the C.S. switch to stop operation, after confirming that the pilot lamp has been lit.



### **Precautionary notes**

- Prior to the film loading, confirm that the system is functioning in proper order, with the transmitter and receiver positioned correctly for immediate use. This can be readily ascertained through the lit pilot lamp and/or by the advancing film counter of the camera itself (particularly, in the event the transmitter-receiver distance may be beyond normal range).

- When photographing at a slow shutter speed, emit the subsequent signal after the shutter has been completely released.

- To avoid possible accidental triggering, when two or three sets of the infrared remote control system are utilized simultaneously at a given location, different channels should be set for each separate combination of units.

- In photographing in the AE mode (other than the LX), utilize the accessory viewfinder cap to avoid light penetration through the viewfinder eyepiece.

- It is highly recommended that the transmitter flash and the receiver window be facing one another in a straight path. Indoors, the system may be triggered due to reflected signal off buildings or walls though the signal transmitting/receiving windows may not be positioned to face one another.

- Only such cameras that are provided with the electromagnetic shutter release allow the use of the Bulb (B) long exposure in combination with this particular system; the transmitter's C.S switch is positioned to "C", when used this way. The bulb extended time exposure (shutter kept fully opened) may be utilized by maintaining trigger button pressure; and stopped by removal of finger pressure upon the trigger button, or releasing the trigger lock lever.

## OPTIONAL SHOE BRACKET

A specially designed shoe bracket is optionally available to be utilized when a camera's hotshoe is occupied by a flash unit, or whenever a camera does not possess a shoe. The optional shoe can be utilized to connect the receiver to the camera, or to join the receiver with the flash unit for cordless, multi-flash photographic requirements. The shoe bracket is recommended in the following instances:

1. A flash unit is already attached onto the camera hotshoe.
2. Photographing with a camera in a vertical position.
3. Signals emanating from either below or above the camera itself.

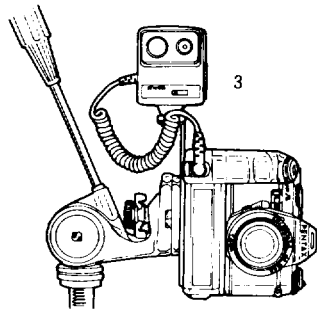
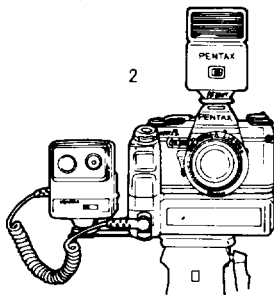
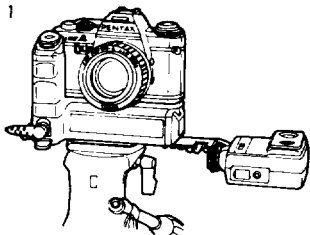



## CORDLESS MULTI-FLASH PHOTOGRAPHY

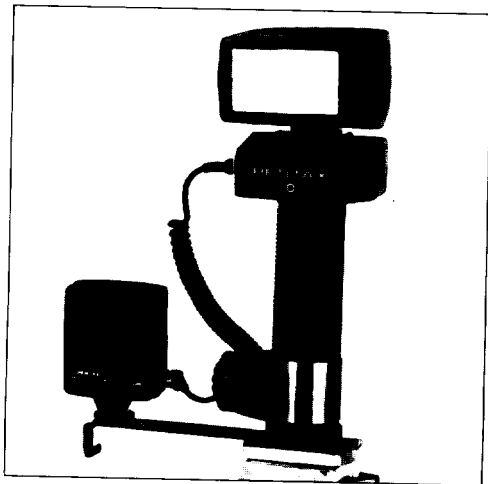

The manual shutter release of the camera will permit the synchronized flash operation of the separate flash unit(s) in use, under the following situations (as illustrated in 1 and 2 on the opposite page); when utilizing a separate flash through

a cordless operation, or triggering and activating two-step multiple flash units for simultaneous firing. The addition of an accessory "distributor," when used in wireless/wired combination, permits multi-flash operation with a single receiver. In this event, the receiver's synchro cord socket should be connected to an AF400T flash unit or to the 4P outlet of the hotshoe grip, via the utilization of the optional 4P synch cord C.

Following the signal emitted from the transmitter, there may be a slight delay prior to the actual shutter activation. In utilizing the foregoing cordless procedures, it is therefore recommended that the shutter speed be adjusted for each model being used according to the following guide line:

Camera	Preferred manual shutter speed
LX, Super A, Super Program, MEF, ME Super,	Slower than 1/60 sec.
*MX	Slower than 1/30 sec.
6x7	Slower than 1/15 sec.

\* Usable only in the cordless flash mode

## Cordless Flash

Fig. 1

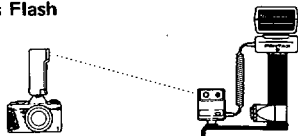
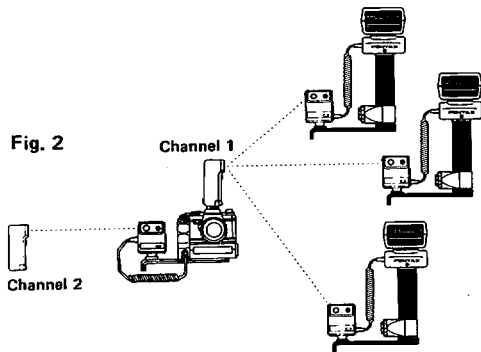

Fig. 2



### Precautionary notes

- Confirm that the Power/C.S switch (transmitter) is set to "S" designation.
- The TTL auto flash mode is not applicable, even though it may be a dedicated flash unit, as the operation is cordless and therefore is separate from the camera.
- The utilization of flash under external-metering auto flash modes may not produce an appropriate exposure, depending upon the existing photographic condition (for example, unusual or adverse lighting situations). Thus, it is recommended that several pictures be taken at different aperture values (by changing f/stops for proper flash exposure control).
- The following formula may be used in calculating the guide number, when multiple units (3 units) of manual type are utilized from the same direction.

$$[GN] = \sqrt{(GN_1)^2 + (GN_2)^2 + (GN_3)^2}$$

Proper aperture value can be obtained by taking into consideration the flash-to-subject distance and other related factors involved.

When using this system with other manufacturers' products, please confirm prior to your actual use if this system synchronizes well with such products.

## SPECIFICATIONS

### Infrared Remote Control Transmitter

**Transmission system:** Infrared ray pulses.

**Number of transmission channels:** 3.

**Modes:** C (consecutive shooting), S (single frame shooting).

**Transmission interval:** Less than 0.7 sec.

**Number of possible transmissions:** about 1,000 times (with fresh alkaline-manganese batteries).

**Max. distance:** Approx. 60m in beeline.

**Transmission button:** One-touch operation for both C & S modes.

**Power source:** Two 1.5V AA-size manganese or alkaline-manganese batteries.

**Other:** Transmitter can be mounted in camera hotshoe and will emit pulses when shutter is pressed; transmitter can control multiple units.

**Dimensions:** 36(W) x 145(H) x 62mm(T)

**Weight:** 150 g

### Infrared Remote Control Receiver

**Reception system:** Designed to receive only those infrared pulses sent by transmitter.

**Number of channels:** 3.

**Mode:** Selection of C or S automatically controlled by transmitter.

**Max. reception distance:** Approx. 60m in beeline.

**Power source:** One 6V alkaline, silver or lithium battery.

Power supply possible from Motor Drive (Motor Drive LX and A) using a special cord.

**Continuous stand-by time:** Approx. 15 hours (with fresh battery).

**Other:** 2P trigger terminal provided (used to connect the receiver to camera's electromagnetic shutter release via infrared remote release cord 2P; multiple flash unit operation possible; DIN X terminal provided).

**Dimensions:** 64(W) x 95(H) x 40mm(T)

**Weight:** 130 g

## GENERAL PRECAUTIONS CONCERNING PROPER CARE OF SYSTEM

- Do not attempt to disassemble unit(s), since a high voltage component has been incorporated; it can result in a heavy accidental electrical shock.
- In mounting/dismounting the receiver or transmitter onto the hotshoe, the hotshoe itself or the section nearest should be held; do not attempt to force the transmitter/receiver into the camera hotshoe by twisting same while holding onto the top of the units – it may damage the hotshoe.
- The transmitter/receiver should not be cleaned by using solvents such as thinners or other compounds; it can cause damage to the delicate electrical components. Cleaning should be limited to using a soft clean cloth or a silicone-impregnated cloth.
- The Pentax Infrared Remote Control system is a highly sophisticated product incorporating a series of complex circuits and components. It should not be subjected to conditions of high temperature/humidity/vibrations or sudden shocks, for they may prove harmful. Avoid storage or use in a car or near heating units. Treat the system with proper care, and it will continue to perform satisfactorily over the years.



**Asahi Optical Co., Ltd.** C.P.O. 895, Tokyo 100-91, JAPAN  
**Asahi Optical Europe N.V.** Weiveldlaan 3-5, 1930 Zaventem Zuid-7, BELGIUM  
**Pentax Handelsgesellschaft mbH** Postfach 54 0169, 2000 Hamburg 54, WEST GERMANY  
**Pentax U.K. Limited** Pentax House, South Hill Avenue, South Harrow, Middlesex HA2 0LT, U.K.  
**Pentax France S.A.**, 72-76 rue Paul Vaillant Couturier, 92300 Levallois-Perret, FRANCE  
**Pentax (Schweiz) AG** Industriestrasse 2, 8305 Dietlikon ZH, SWITZERLAND  
**Pentax Svenska AB** Hornsgatan 50A, 11721 Stockholm, SWEDEN  
**Pentax Nederland** Spinveld 25, 4815 HR Breda, THE NETHERLANDS  
**Pentax Corporation** 35 Inverness Drive East, Englewood, Colorado 80112, U.S.A.  
**Pentax Canada Inc.** 1760 West 3rd Avenue, Vancouver, B.C. V6J 1K5, CANADA  
**Asahi Optical Brasileira Ind. e Com. Ltda.** Rua Estados Unidos, 1053, São Paulo-SP, BRASIL