

PENTAX

VHS VIDEO CAMERA/RECORDER

MODEL **PV-C77A**

INSTRUCTION MANUAL

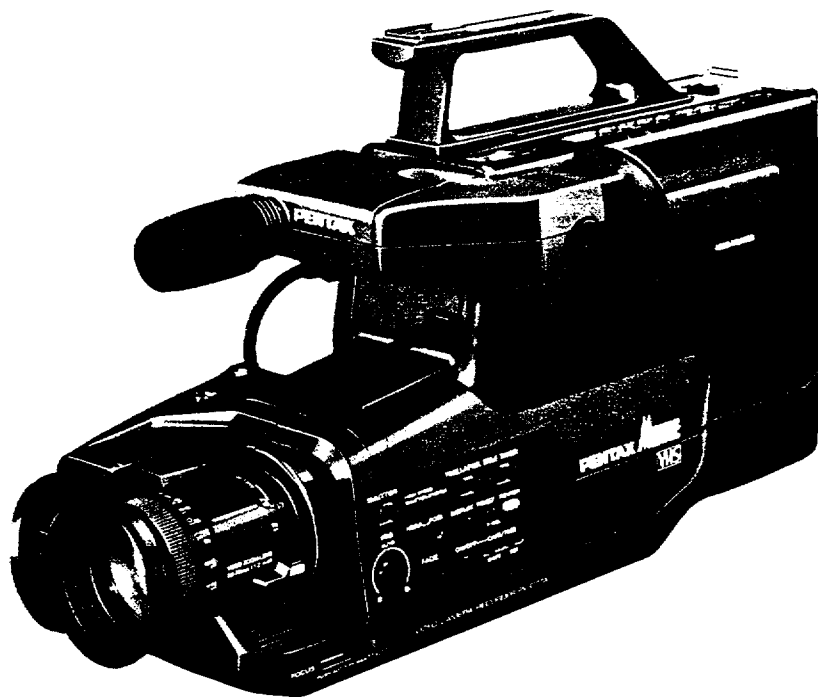

PENTAX *MOVIE*

WARNING: TO PREVENT FIRE OR SHOCK HAZARD, DO NOT EXPOSE THIS UNIT TO RAIN OR MOISTURE.

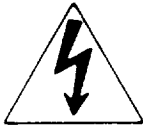

CAUTION
RISK OF ELECTRIC SHOCK
DO NOT OPEN



This symbol warns the user that uninsulated voltage within the unit may have sufficient magnitude to cause electric shock. Therefore, it is dangerous to make any kind of contact with any inside part of this unit.

CAUTION: TO REDUCE THE RISK OF ELECTRIC SHOCK, DO NOT REMOVE COVER (OR BACK). NO USER - SERVICEABLE PARTS INSIDE. REFER SERVICING TO QUALIFIED SERVICE PERSONNEL.



This symbol alerts the user that important literature concerning the operation and maintenance of this unit has been included. Therefore, it should be read carefully in order to avoid any problems.

CAUTION:
TO PREVENT ELECTRIC SHOCK DO NOT USE THIS (POLARIZED) PLUG WITH AN EXTENSION CORD, RECEPTACLE OR OTHER OUTLET UNLESS THE BLADES CAN BE FULLY INSERTED TO PREVENT BLADE EXPOSURE.

MOISTURE

Moisture may occur if the video camera/recorder is moved from a cold area to a warm humid area. A flashing "POWER" light indicates that moisture is on the recorder mechanism, which could result in tape damage. When the "POWER" light is flashing the unit will not operate. When this happens, press the "EJECT" button, remove the tape, and wait for the moisture to dry the "POWER" indicator will stop flashing.

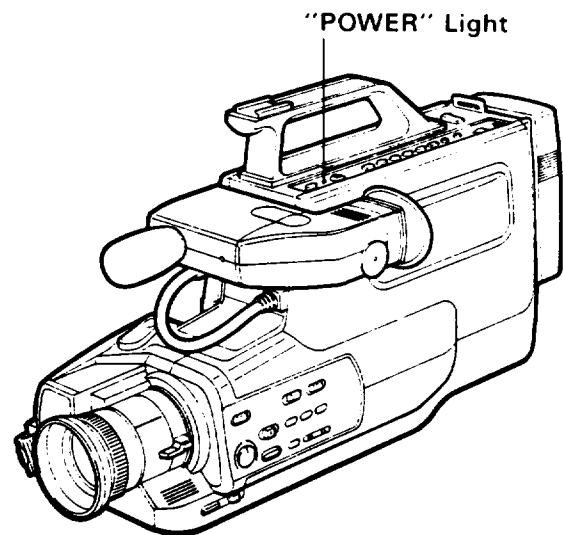

Read the Important Safety Instructions for AC adaptor charger before use.

PRECAUTIONS

- **No water, dust or sand**
Be careful that no water, dust or sand enters the camera/recorder.
- The solid-state image sensor is basically immune to direct sunlight or excessively bright objects, but, avoid prolonged exposure.
- When you are not using the camera/recorder, switch off the power and attach the lens cap.
- Be sure not to leave it in a place where the temperature exceeds 120°F, or the pickup device may be damaged.
Dangerous includes:
 - Inside a car with the windows closed and in direct sunshine.
 - Near heating appliances.
- Do not leave the viewfinder lens facing sunlight for a prolonged period, or the phosphorescent surface of the cathode ray tube may be damaged.

Congratulations on buying the **VHS** video camera/recorder. For maximum pleasure and convenience please read these simple instructions before operating your camera/recorder.

WARNING: Many television programs and films are copyrighted. In certain circumstances, copyright law may apply to private in-home video taping of copyrighted materials.

* **HQ** This video camera/recorder with this marking incorporates **VHS** high-quality picture technology and is compatible with any video tape recorder bearing the **VHS** mark.

FEATURES

- Solid-state camera pickup
- **HQ** High Quality picture technology
- Auto Focus Power Zoom Lens with macro feature
- Full record and playback capability with standard **VHS** cassette
- High speed shutter
- Time-lapse and one-shot recording

ACCESSORIES

Check to make sure you have the following components and accessories (besides the camera/recorder unit itself) before disposing of the packing material.

1. AV Input Cable
2. Battery Pack
3. AC Adaptor Charger
4. RF Converter Unit
5. 75-ohm Coaxial Cable with Antenna Adaptor (75/300-ohm), 1.5 m
6. Antenna Adaptor (300-ohm to 75-ohm)
7. Shoulder Strap
8. AV Output Cable
9. DC Cord
10. Battery for Clock

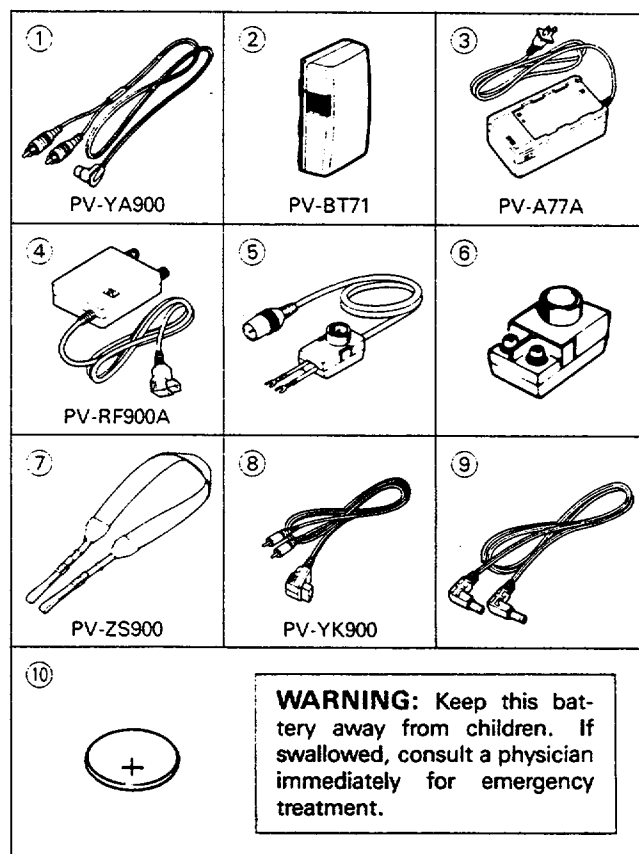

This digital apparatus does not exceed the Class B limits for radio noise emissions from digital apparatus set out in the Radio Interference regulations of the Canadian Department of Communications.

IMPORTANT SAFEGUARDS

In addition to the careful attention devoted to quality standards in the manufacture of your video product, safety is a major factor in the design of every instrument. But, safety is your responsibility too.

This page lists important information that will help to assure your enjoyment and proper use of a Video Camera/Recorder and accessory equipment. Please read it carefully before operating your video product and keep it in a handy place for future reference.

INSTALLATION

- 1 Read and Follow Instructions**—All the safety and operating instructions should be read before the video product is operated. Follow all operating and use instructions.

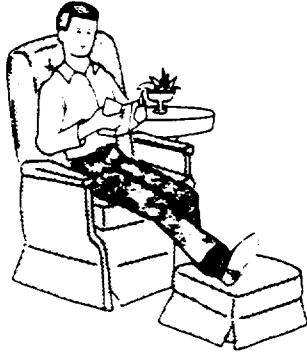

- 2 Retain Instructions**—The safety and operating instructions should be retained for future reference.

- 3 Heed Warnings**—Comply with all warnings on the video product and in the operating instructions.

- 4 Polarized Plug**—This video product is equipped with a polarized alternating-current line plug (a plug having one blade wider than the other). This plug will fit into the power outlet only one way. This is safety feature. If you are unable to insert the plug fully into the outlet, try reversing the plug. If the plug should still fail to fit, contact your electrician to replace your obsolete outlet. To prevent electric shock do not use this polarized plug with an extension cord, receptacle or other outlet unless the blades can be fully inserted without blade exposure. If you need an extension, use a polarized cord.

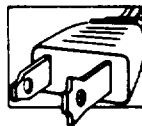

- 5 Power Sources**—This video product should be operated only from the type of power source indicated on the marking label. If you are not sure of the type of power supply to your home, consult your video dealer or local power company. For video products intended to operate from battery power, or other sources, refer to the operating instructions.

- 6 Overloading**—Do not overload wall outlets and extension cords as this can result in a risk of fire or electric shock. Overloaded AC outlets and extension cords are dangerous, and so are frayed power cords, damaged or cracked wire insulation and broken plugs. They may result in a shock or fire hazard. Periodically examine the cord and have it replaced by your service technician if appearance indicates damage or deteriorated insulation.

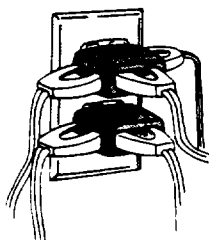

- 7 Power-Cord Protection**—Power-supply cords should be routed so that they are not likely to be walked on or pinched by items placed upon or against them, paying particular attention to cords at plugs, convenience receptacles, and the point where they exit from the appliance.

- 8 Ventilation**—Slots and openings in the cabinet are provided for ventilation to ensure reliable operation of the video product and to protect it from overheating. These openings must not be blocked or covered. The openings should never be blocked by placing the video product on a bed, sofa, rug, or other similar surface. This video product should never be placed near or over a radiator or heat register. This video product should not be placed in a built-in installation such as a bookcase or rack unless proper ventilation is provided or the video product manufacturer's instructions have been followed.

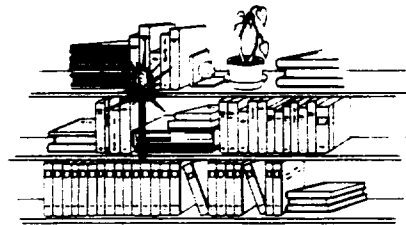

- 9 Attachments**—Do not use attachments unless recommended by the video product manufacturer as they may cause hazards.

Caution: Maintain electrical safety. Powerline operated equipment or accessories connected to this unit should bear the UL listing mark or CSA certification mark on the accessory itself and should not have been modified so as to defeat the safety features. This will help avoid any potential hazard from electric shock or fire. If in doubt, contact qualified service personnel.

- 10 Water and Moisture**—Do not use this video product near water—for example, near a bath tub, wash bowl, kitchen sink, or laundry tub, in a wet basement, or near a swimming pool, and the like.

- 11 Accessories**—Do not place this video product on an unstable cart, stand, tripod, bracket, or table. The video product may fall, causing serious injury to a child or adult, and serious damage to the appliance. Use only with a cart, stand, tripod, bracket, or table recommended by the manufacturer, or sold with the video product. Any mounting of the product should follow the manufacturer's instructions, and should use a mounting accessory recommended by the manufacturer.

- 11A** An appliance and cart combination should be moved with care. Quick stops, excessive force, and uneven surfaces may cause the appliance and cart combination to overturn.



S3125A

12 Outdoor Antenna Grounding—If an outside antenna or cable system is connected to the video product, be sure the antenna or cable system is grounded so as to provide some protection against voltage surges and built-up static charges. Section 810 of the National Electrical Code, ANSI/NFPA No. 70-1984, provides information with respect to proper grounding of the mast and supporting structure, grounding of the lead-in wire to an antenna discharge unit, size of grounding conductors, location of antenna-discharge unit, connection to grounding electrodes, and requirements for the grounding electrode. See example below.

EXAMPLE OF ANTENNA GROUNDING ACCORDING TO NATIONAL ELECTRICAL CODE INSTRUCTIONS CONTAINED IN ARTICLE 810 — "RADIO AND TELEVISION EQUIPMENT"

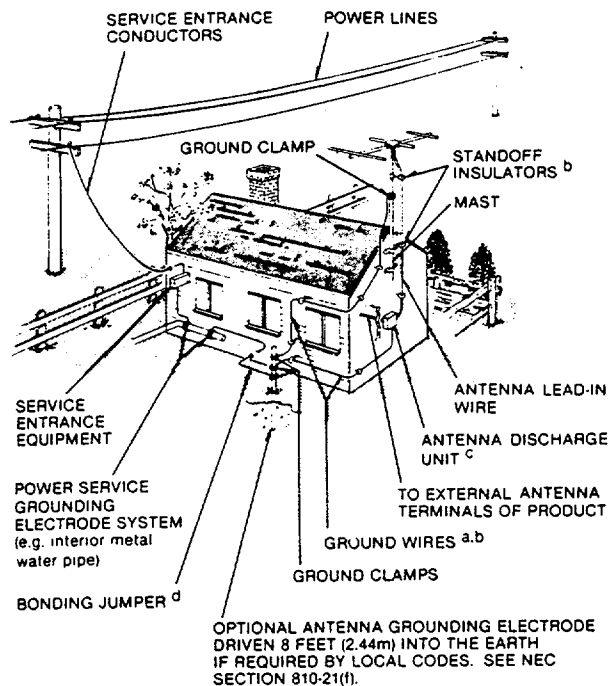

a. Use No. 10 AWG copper or No. 8 AWG aluminum or No. 17 AWG copper-clad steel or bronze wire, or larger as ground wires for both mast and lead-in.

b. Secure lead-in wire from antenna to antenna discharge unit and both ground wires to house with stand-off insulators, spaced from 4 feet (1.22 meters) to 6 feet (1.83 meters) apart.

c. Mount antenna discharge unit as close as possible to where lead-in enters house.

d. Use jumper wire not smaller than No. 6 AWG (13.3 mm²) copper, or the equivalent, when a separate antenna-grounding electrode is used. See NEC Section 810-21(j).

13 Power Lines—An outside antenna system should not be located in the vicinity of overhead power lines or other electric light or power circuits, or where it can fall into such power lines or circuits. When installing an outside antenna system, extreme care should be taken to keep from touching or approaching such power lines or circuits as contact with them might be fatal. Installing an outdoor antenna can be hazardous and should be left to a professional antenna installer.

USE

14 Cleaning—Unplug this video product from the wall outlet before cleaning. Do not use liquid cleaners or aerosol cleaners. Use a damp cloth for cleaning.

15 Object and Liquid Entry—Never push objects of any kind into this video product through openings as they may touch dangerous voltage points or short-out parts that could result in a fire or electric shock. Never spill liquid of any kind on the video product.

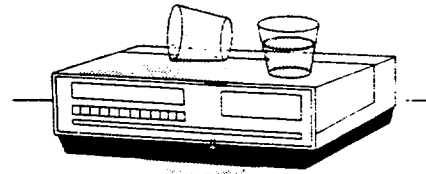

16 Lightning—For added protection for this video product during a lightning storm, or when it is left unattended and unused for long periods of time, unplug it from the wall outlet and disconnect the antenna or cable-system. This will prevent damage to the video product due to lightning and power-line surges.

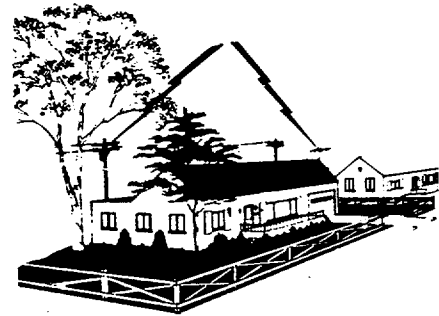

SERVICE

17 Servicing—Do not attempt to service this video product yourself as opening or removing covers may expose you to dangerous voltage or other hazards. Refer all servicing to qualified service personnel.

18 Conditions Requiring Service—Unplug this video product from the wall outlet and refer servicing to qualified service personnel under the following conditions.

- When the power-supply cord or plug is damaged.
- If liquid has been spilled, or objects have fallen into the video product.
- If the video product has been exposed to rain or water.
- If the video product does not operate normally by following the operating instructions. Adjust only those controls that are covered by the operating instructions. Improper adjustment of other controls may result in damage and will often require extensive work by a qualified technician to restore the video product to its normal operation.
- If the video product has been dropped or the cabinet has been damaged.
- When the video product exhibits a distinct change in performance—this indicates a need for service.

19 Replacement Parts—When replacement parts are required, have the service technician verify that the replacements he uses have the same safety characteristics as the original parts. Use of replacements specified by the video product manufacturer can prevent fire, electric shock or other hazards.

20 Safety Check—Upon completion of any service or repairs to this video product, ask the service technician to perform safety checks recommended by the manufacturer to determine that the video product is in safe operating condition.

TABLE OF CONTENTS

Features.....	3	Self timer.....	26
Accessories.....	3	Negative/positive inversion.....	26
Important safeguards.....	4	Time lapse recording.....	27
Electronic viewfinder position adjustment.....	6	One shot recording.....	27
How to install the shoulder strap.....	7	Index signal recording.....	28
Loading battery for date/clock.....	7	Eyepiece adjustment.....	28
Power sources.....	7	Microphone mixing.....	28
Checking the battery.....	9	Recording TV program.....	29
Charging the battery.....	9	Audio dubbing.....	30
Making a sample camera recording.....	10	Video dubbing.....	31
Identification and operation of controls.....	12	Viewing the picture played back on your TV.....	32
Date/clock setting.....	20	Still.....	34
Auto focus.....	21	F-search and R-search.....	34
Auto iris.....	22	Camera/Recorder to VCR dubbing.....	35
Instant review.....	23	Edit search.....	35
Fade in fade out.....	23	Flying erase head.....	35
Power zoom.....	24	Troubleshooting.....	36
Variable shutter speed.....	24	Head cleaning.....	38
Display button.....	25	Periodic maintenance.....	38
Memory.....	25	Specifications.....	38
Time remaining.....	25	Optional accessories.....	39

ELECTRONIC VIEWFINDER POSITION ADJUSTMENT

The position of the Electronic Viewfinder can be adjusted so it can be viewed with the left eye as well as the right eye.

- When viewing with right eye

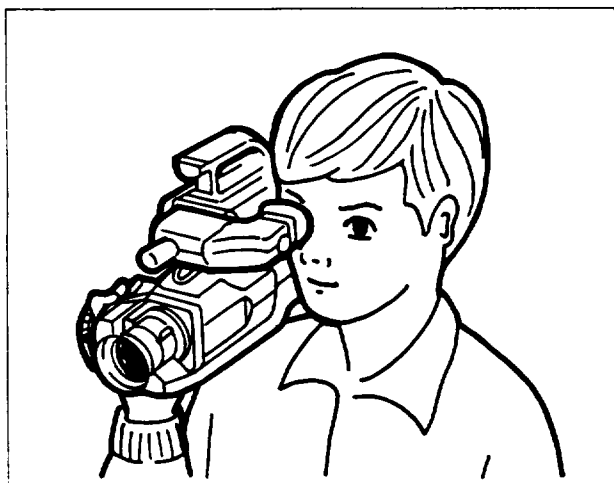

- When viewing with left eye

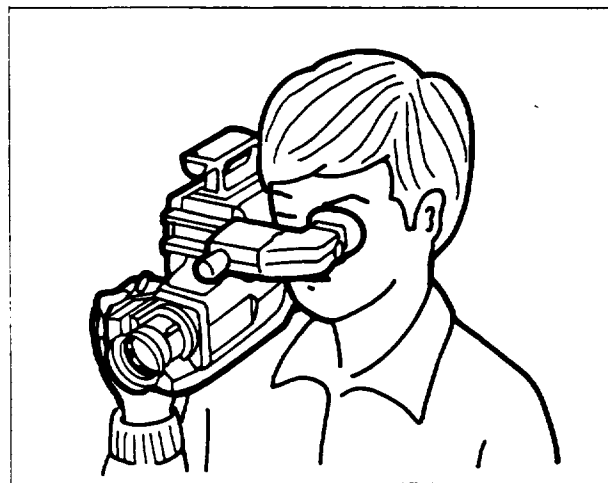

HOW TO INSTALL THE SHOULDER STRAP

Attach the shoulder strap (Accessory No. 7), as illustrated.

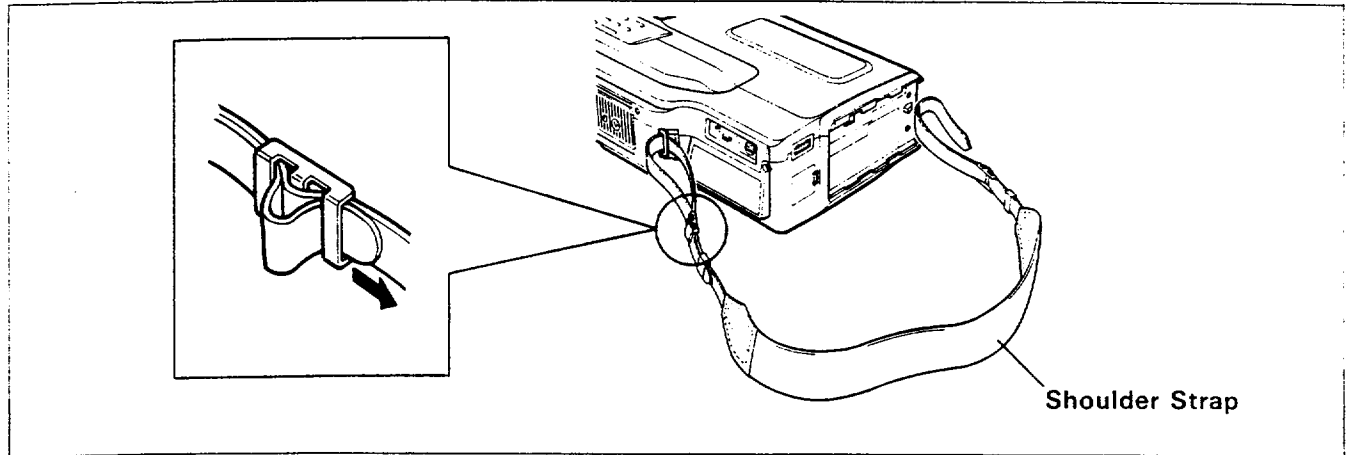

LOADING BATTERY FOR DATE/CLOCK

You may want to install the clock battery (Accessory No. 10) immediately to prevent misplacing it.

1. Pull the tab to open the cover and expose the compartment.
2. Insert the clock battery with the "+" terminal facing out (as illustrated inside the battery cover).
3. Gently push the cover closed until it snaps into place.

NOTES:

- When replacing the batteries, use 3V micro lithium cell such as Maxell CR2025 or equivalent.
- Instructions for setting the time and date are on page 20. You can do that later if desired after you're more familiar with your camera/recorder.

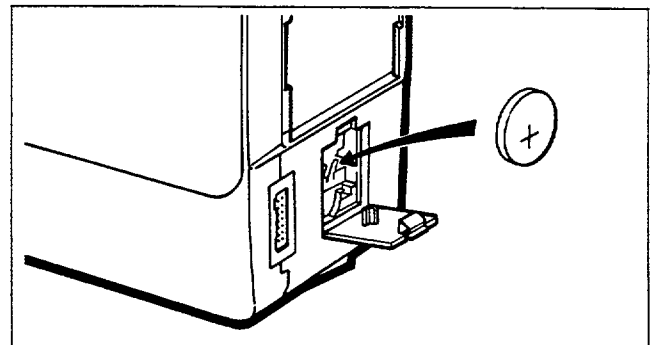

POWER SOURCES

■ WHEN USING WITH THE BATTERY (Accessory No. 2)

1. To attach align the mark "▶" on the side of the battery with that on the rear left side of the camera/recorder so that the battery fits into the grooves, and slide the battery downward, as illustrated.
2. To remove slide the battery upward while sliding the "BATTERY" eject lever in the direction of the arrow.

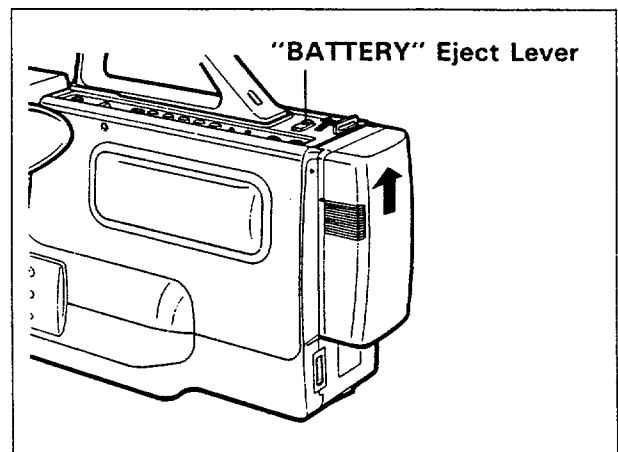
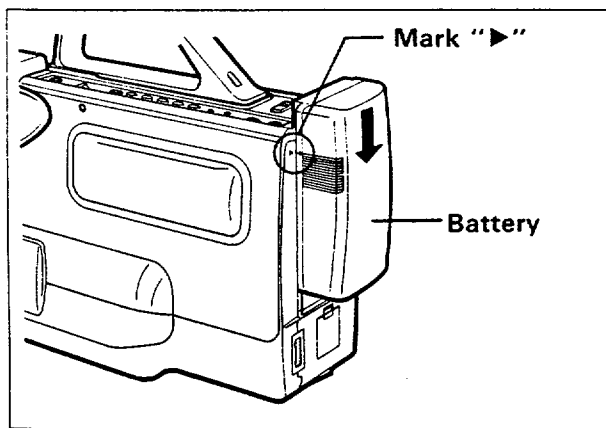

■ WHEN USING WITH THE AC ADAPTOR CHARGER (Accessory No. 3)

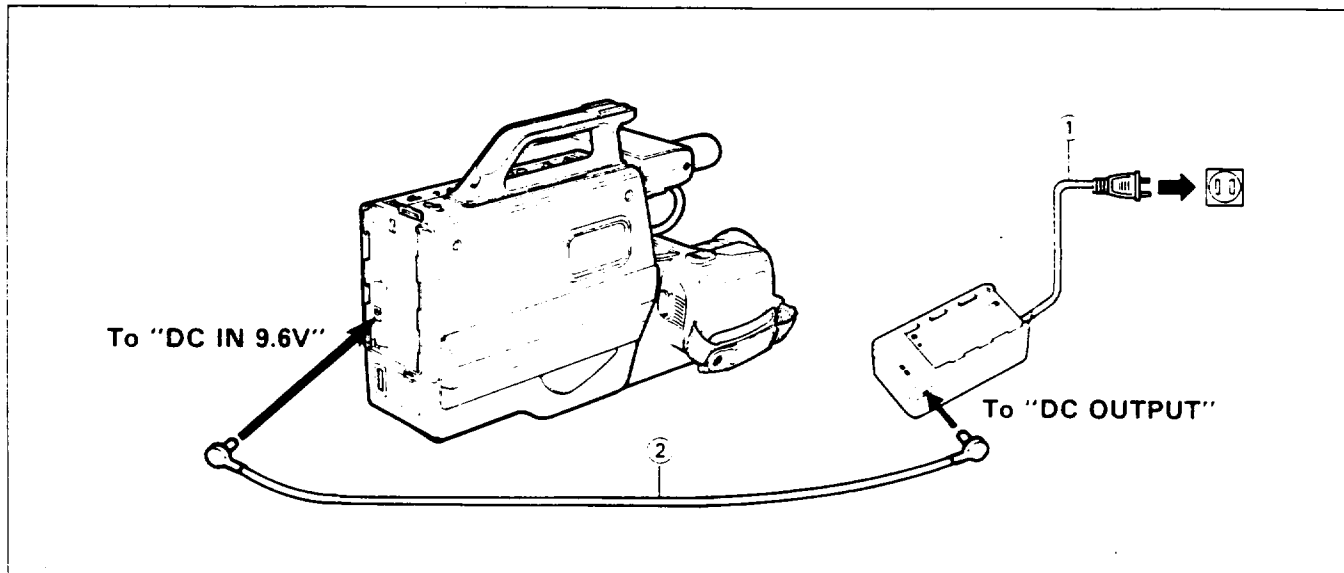

1. Plug the AC adaptor charger power cord into AC electrical outlet.

NOTE: This adaptor charger is universal for use with AC 100 – 240V around the world.

2. Connect one end of the DC cord (provided) to the "DC IN 9.6V" jack of the camera/recorder. Connect the other end of the DC cord to the "DC OUTPUT" of the AC adaptor charger.

NOTE: The AC adaptor charger cannot charge the battery and operate the camera/recorder at the same time. Remove the battery from the AC adaptor charger to supply power to the camera/recorder.

See the bottom of the AC adaptor charger. The rating label is located on the bottom of the AC adaptor charger.

■ WHEN USING WITH THE CAR BATTERY (By using optional car battery cord Pentax PC-YC77)

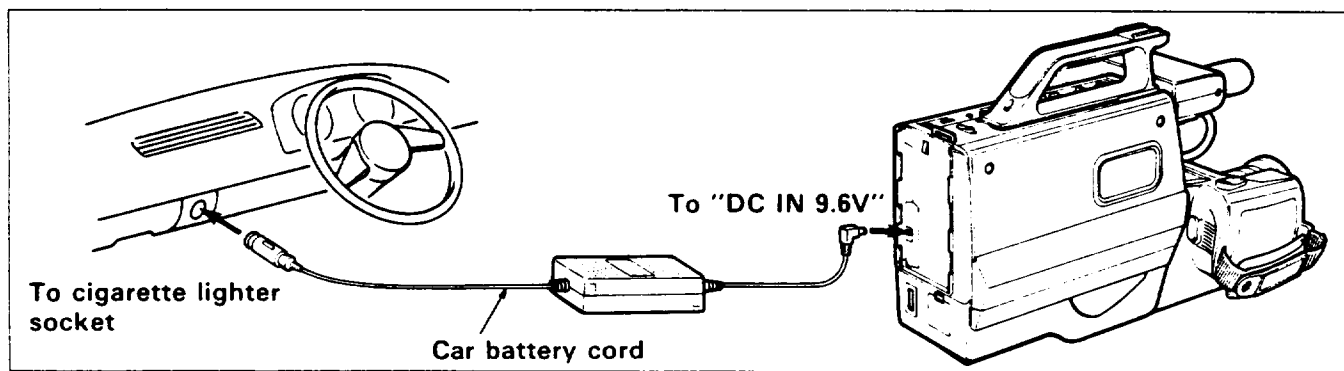

1. Connect the small plug of the car battery cord to the "DC IN 9.6V" jack of the camera/recorder.
2. Connect the other of the car battery cord to the car's cigarette lighter socket.

NOTES:

- The car cord is designed to be used only with automobiles having a 12-volt negative ground system.
- To avoid possible damage to your camera/recorder, make sure the car cord you plan to use has positive tip polarity and is capable of converting 12 volts to 9.6 volts such as Pentax model PC-YC77.

CHECKING THE BATTERY

When the "E" indication in the viewfinder appears and flashes while the camera/recorder is operated with a battery (Accessory No. 2) during recording, it indicates that the battery charge is insufficient. Then, charge it or replace it with a charged battery.

NOTE: Whenever the tape counter or time remaining display is present in the viewfinder, it appears with a 3-dash read-out indicating the condition of camera/recorder battery power. When the battery is fully charged, the display reads "E---F". After several minutes, only two dashes appear.

When the battery is very near empty, only one dash remains. When the last dash starts blinking, you should find an alternative power source or recharge the battery before continuing to use your camera/recorder.

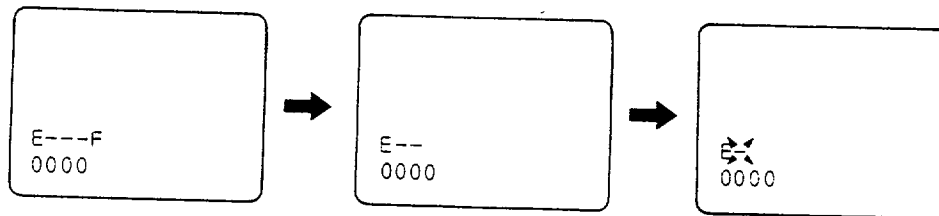
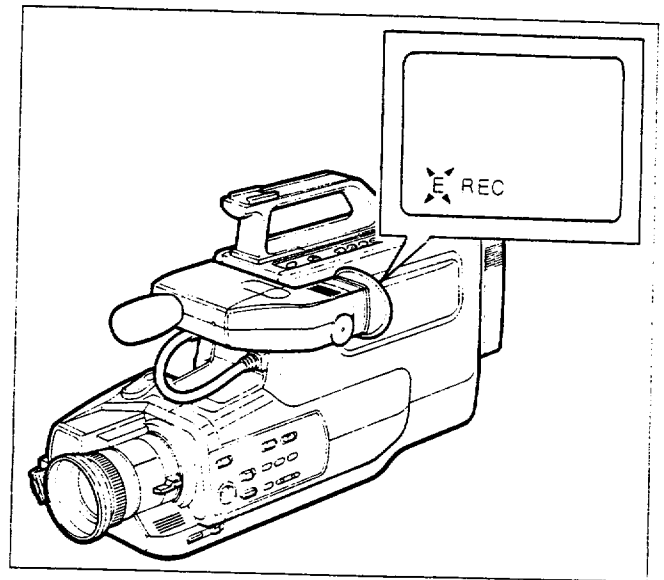

CHARGING THE BATTERY

1. Plug the AC adaptor charger power cord into AC electrical outlet.
2. Attach the battery to the AC adaptor charger. Align the reference arrow on the battery with that of AC adaptor charger and push the battery flush with the AC adaptor charger and slide it in the direction of arrow.

NOTE: You must remove the DC cord from the AC adaptor charger to charge the battery. If the DC cord is connected, charge light will flash.

3. The charge light will be lit while the battery is accepting a charge, and will go out when the battery is fully charged.

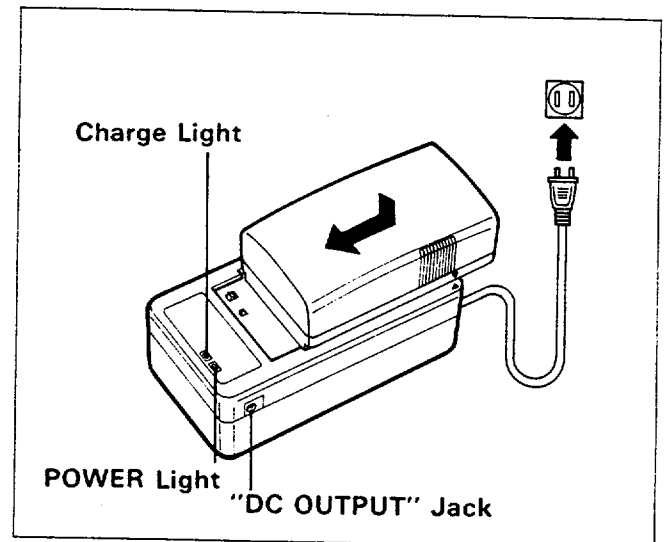

NOTES:

1. The time required for charging the battery is approx. one hour.
2. An optional long play battery (PV-BT72) may also be charged by the AC adaptor charger. The time for battery charging is approx. two hours.
3. Charging is not possible when a DC cord is connected to the DC output jack.
4. When a battery, which has become very hot, is attached to the AC adaptor charger the "POWER"

light of the AC adaptor charger flashes. In this event unplug the AC adaptor charger from the AC outlet for approximately ten seconds. After that period the power cord may be plugged back into the AC outlet. Attaching an extremely hot battery to the AC adaptor charger is not recommended; it should be allowed to cool down before being attached.

MAKING A SAMPLE CAMERA RECORDING

1. Connect the POWER SOURCE. (See pages 7 and 8.)
2. Press "EJECT" button and insert the cassette so the transparent window is toward you and the arrow toward the cassette holder. Slide the cassette into cassette holder as far as it will go.

NOTE: If the power source is not connected to camera/recorder, the cassette holder will not open.

3. Press the cassette holder. The holder will latch in the operating position.

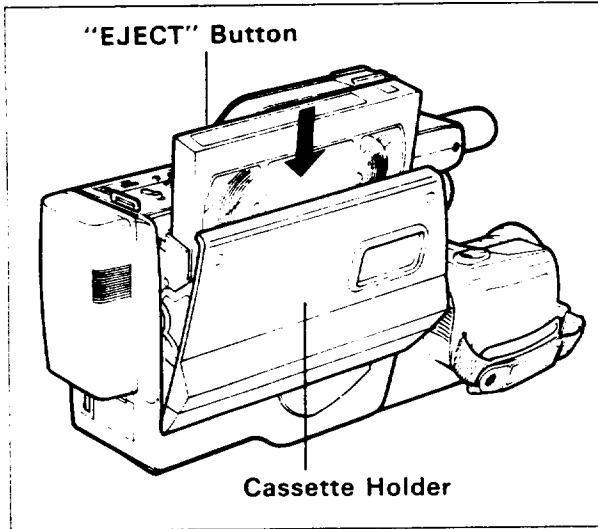

4. Slide "VCR/CAM" select switch to "CAM".
5. Press "POWER" ON/OFF button on. The camera/recorder will enter record/pause mode automatically.

NOTE: If the erase prevention tab on the cassette is removed, the camera/recorder will not enter record/pause mode and recording is not possible.

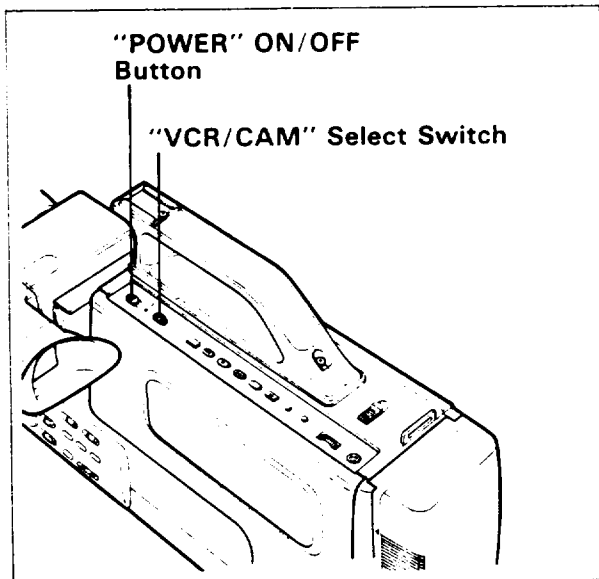

6. Set "IRIS" control to AUTO (center).
7. Set "FOCUS AUTO/MAN" switch to "AUTO".
8. Set "NEGA/POSI" switch to "POSI".

NOTE: See page 28 for "EYEPIECE ADJUSTMENT".

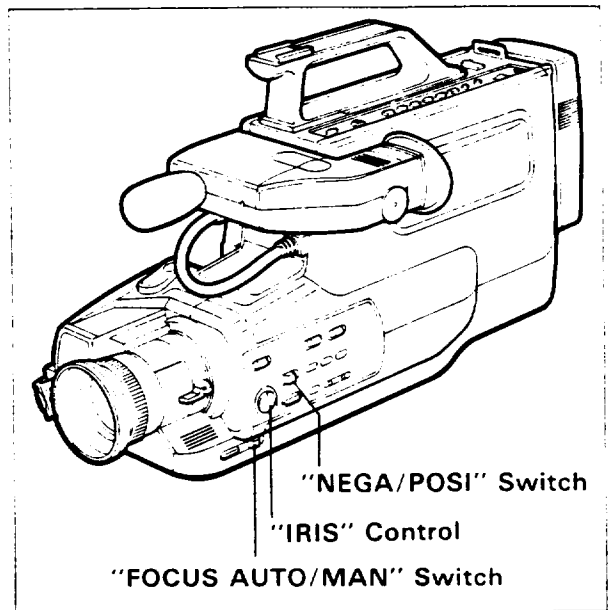

9. Now, press record start/stop button to start shooting the picture. "REC" indication appears in the viewfinder and you are now recording the picture you see through the viewfinder.
10. Press record start/stop button to stop recording. Press the button again to resume recording. The "PAUSE" indication in the viewfinder appears instead of "REC" in the record/pause (stand-by) mode.

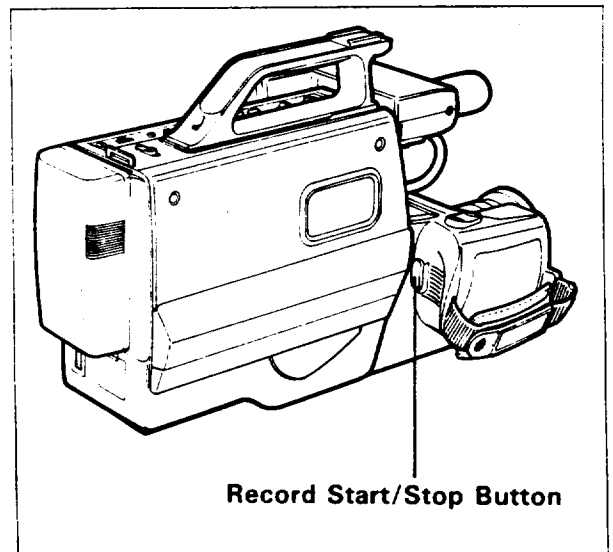

11. After recording, slide "VCR/CAM" select switch to "VCR", and the camera/recorder will be now in the stop mode.

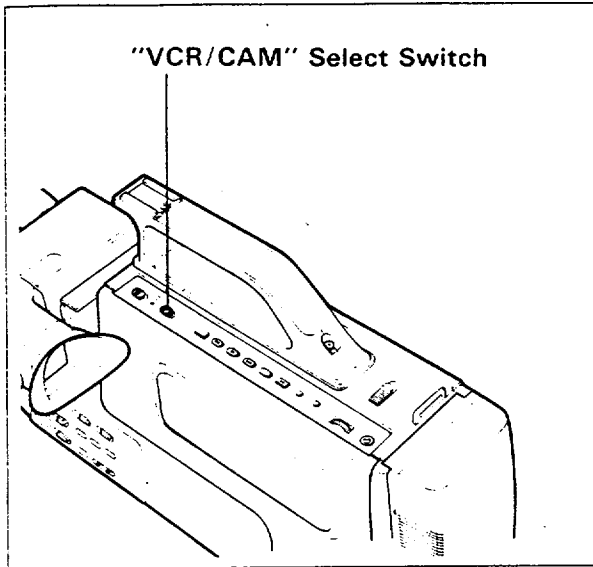

15. Press "POWER" ON/OFF button off and then "EJECT" button to remove cassette.

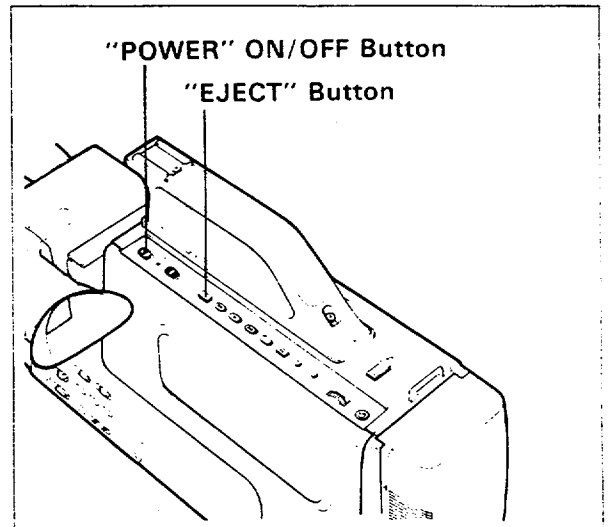

12. Press "REW" button. The tape will be rewound to the beginning.
13. Press "PLAY" button. The picture you just recorded will be seen through the viewfinder and sound can be heard by earphone (Not supplied).

NOTE: If you connect the camera/recorder to your TV, you can see the picture played back on your TV. Refer to "VIEWING THE PICTURE PLAYED BACK ON YOUR TV" on page 32.

14. After playing, press "STOP" button.

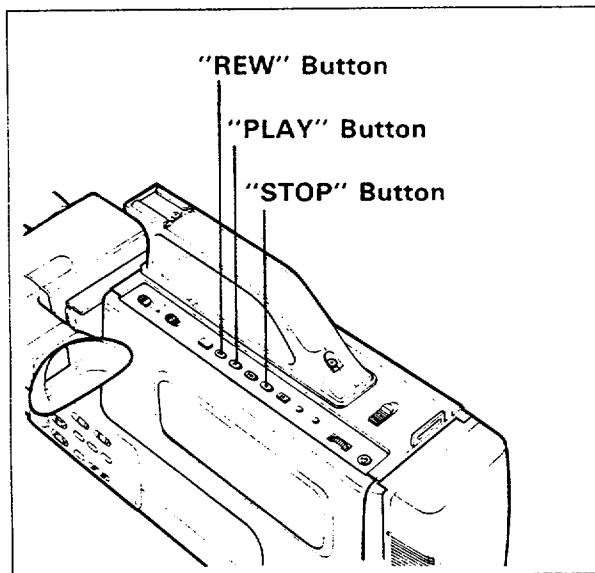

16. Always remove the power source from the camera/recorder after use.

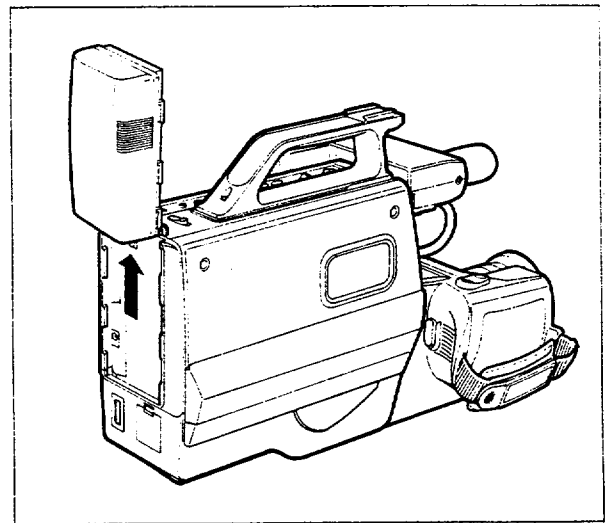

NOTE: If you have a cassette tape that has already been partially recorded on and you want to record the remaining blank section, see "EDIT SEARCH" on page 35.

IDENTIFICATION AND OPERATION OF CONTROLS

“SHUTTER SPEED” Control Switch

Used to control the shutter speed during recording and/or record/pause (stand-by) mode. (See “VARIABLE SHUTTER SPEED” on page 24.)

Power Zoom Switch

This switch performs zooming electrically.

“W”: Picture becomes wider gradually.

“T”: Picture becomes telescopic gradually.

Zoom Ring (Manual Zooming)

The picture size can be magnified 8 times with the use of the zoom feature. Just rotate the zoom ring for a close up (T) or wide angle (W) picture. Macro close-up, as close as 1 cm from object, is feasible.

Focus Ring

Do not attempt to manually turn the focus ring when the camera/recorder is in the auto focus mode.

Auto Focus Window

To automatically focus the camera lens, this window transmits and receives infrared light which is reflected off the object. Make sure you don't obstruct this window when recording.

Lens

F1.2 (8,7–70 mm) 8:1 power zoom lens features auto focus and auto iris functions.

“PUSH AUTO” Focus Button

Auto focusing can be also performed during manual focus mode by pushing this button.

Record Indicator

Flashes for about 10 seconds when the “SELF TIMER” switch is pressed during record/pause (stand-by) mode and stays on to indicate recording starts.

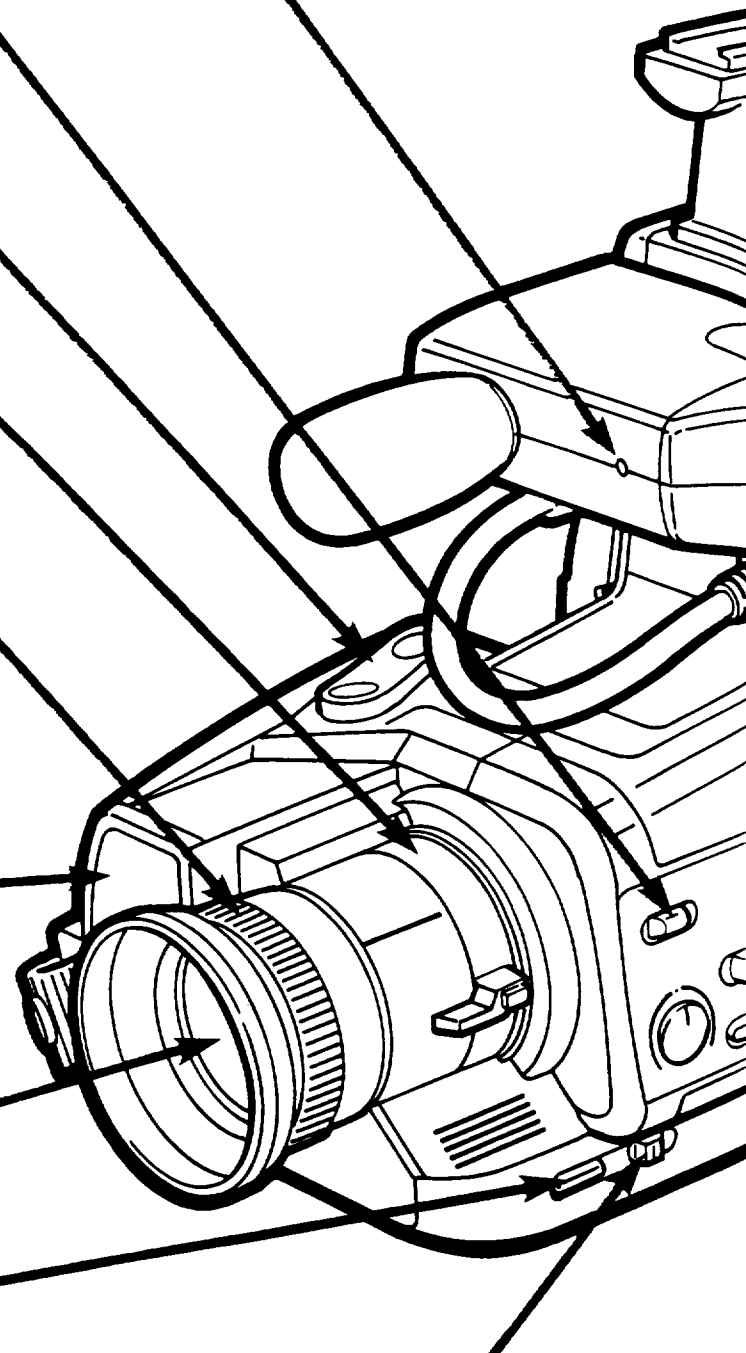

“FOCUS AUTO/MAN” Switch

Set this switch to the “AUTO” position for automatic focusing, and to the “MAN” position for focusing with the focus ring.

Accessory Shoe

Used to attach a camera light (Not supplied).

"BATTERY" Eject Lever

Releases the battery attached to the video camera/recorder.

Earphone Speaker

When you record or play a tape in the camera/recorder you can hear the audio through this speaker. To control the volume, adjust the "SPEAKER" volume control located on the bottom of the camera/recorder.

NOTE: If feed back noise (howling) occurs during recording, turn the "SPEAKER" volume control down and attach the optional earphone to "EAR" phone jack to monitor the sound.

"DISPLAY" Button

Pressing this button once causes a 4 digit tape counter and battery indicator to appear in the camera/recorders viewfinder. Pressing the button again will cause counter memory mark "M" to appear

Pressing the button third time will cause battery indicator and the amount of time remaining on the cassette in the camera/recorder.

Press a 4th time to delete all displays.

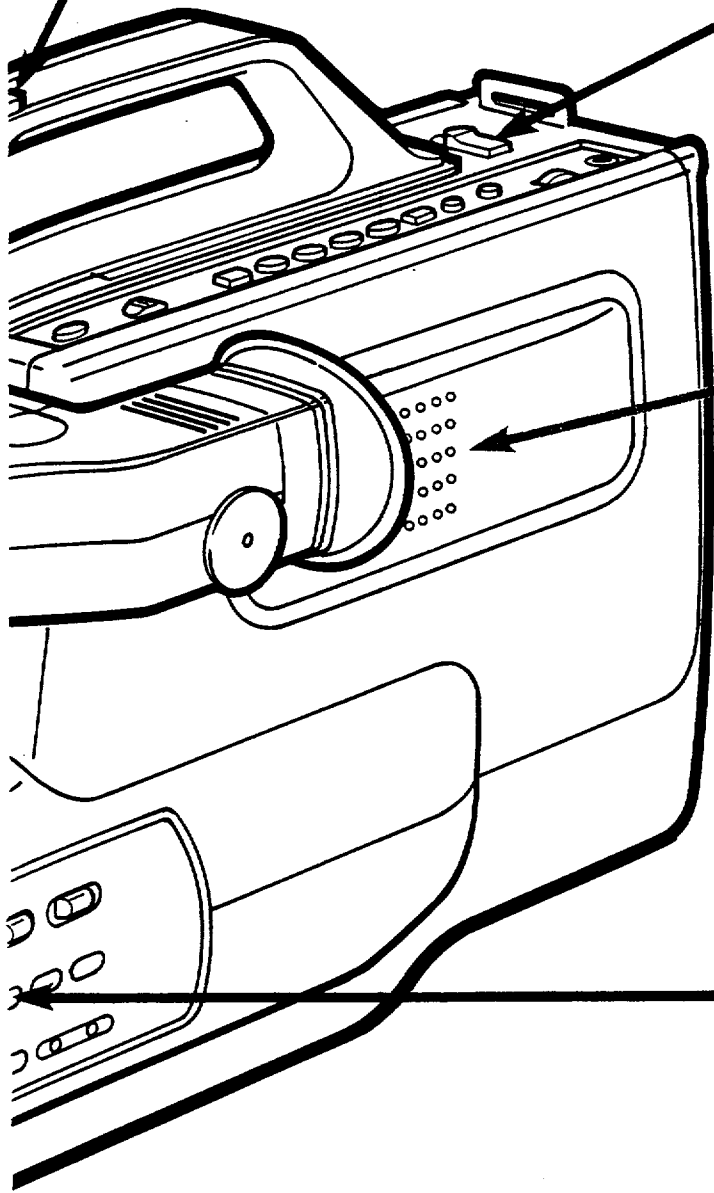

Electronic Viewfinder (EVF)

Displays what the camera/recorder lens sees. The electronic viewfinder also functions as a convenient black-and-white monitor during playback of recorded material.

"NEGA/POSI" Switch

- Normally set to "POSI".
- Set to "NEGA" for special effects as in a negative film.

"IRIS" Control

When this control is in the AUTO (center) position, the iris is controlled automatically. Turn this control to the right or left for manual iris control.

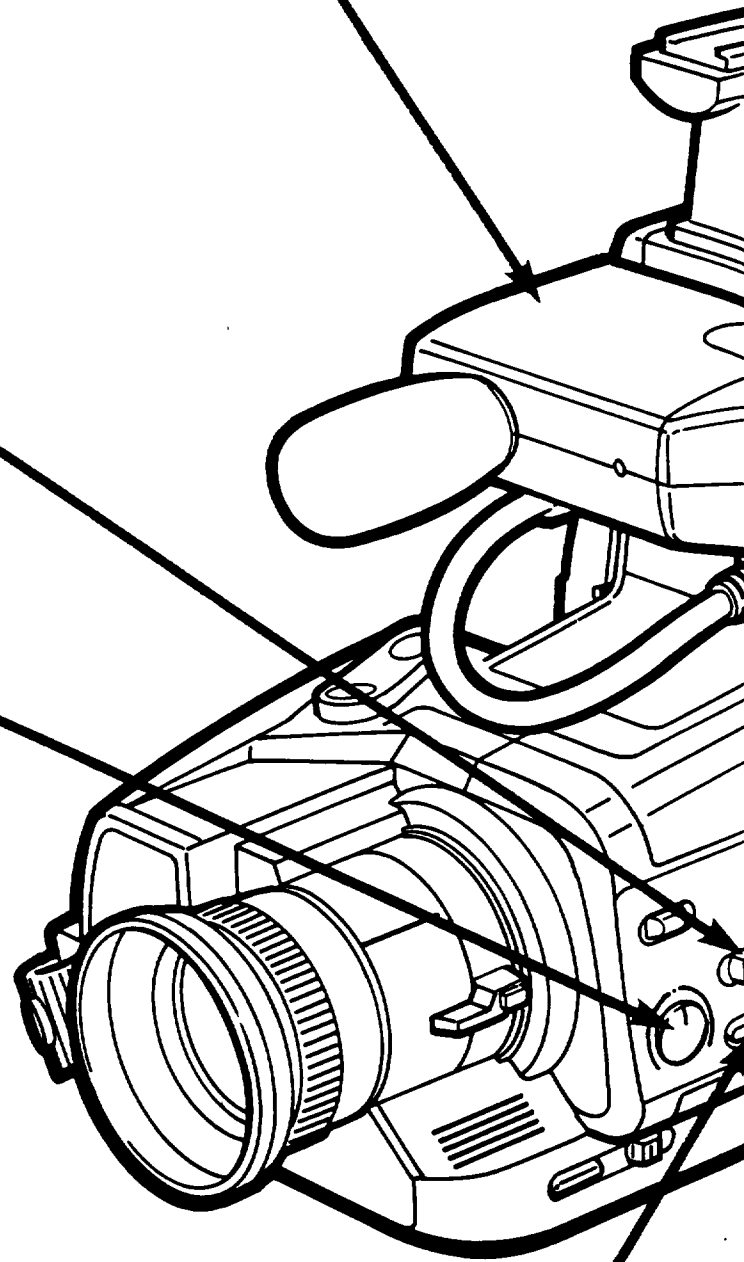

"FADE" Button

During recording you can add a professional touch to your recordings by fading in and out of scenes.

NOTE: When you use to "FADE" button to fade in and out, the sound will also fade in and out with the picture.

"TIME LAPSE" Switch

This switch allows time lapse and one shot recording. See pages 27 and 28.

Diopter Control

To use the electronic viewfinder without eye-glasses on, turn this control knob for your optimum focus adjustment.

"SELF TIMER" Switch

This switch allows you to start recording after about 10 seconds when the switch is pressed. (See "SELF TIMER" on page 26.)

"RESET/T-160" Button

When the tape counter is displayed in the viewfinder, pressing this button resets the counter to "0000".

When the time-remaining read-out is displayed, pressing this button changes the display for extended length T-160 tapes, the indicator under the T-160 button will light.

"REVIEW" Button

Used to review the last few seconds of the recorded segment in the record/pause mode.

"DATE & CLOCK" Set Buttons

These buttons are used to set the clock (time and date) in your camera/recorder so it can be recorded on your tapes for future reference. (See page 20.)

"DATE/TIME" Button

Press this button to display the date and clock in the viewfinder.

Whenever the date and clock appear in the viewfinder, they will be recorded on the tape.

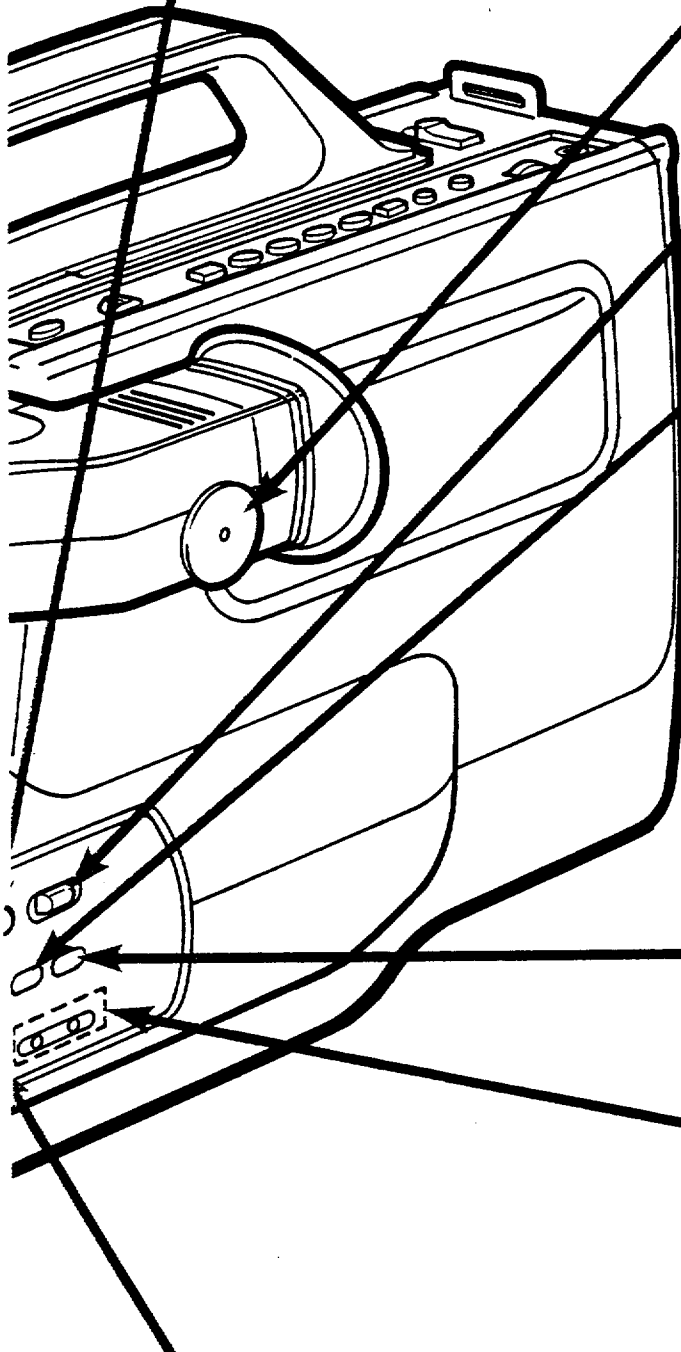

"VCR/CAM" Select Switch

This switch changes the camera/recorder to the record mode or to the playback mode. The switch must be in "CAM" position for recording.

"EJECT" Button

Operates with "POWER" either on or off, if a power source is connected to the camera/recorder.

"POWER" ON/OFF Button

Press "POWER" ON/OFF button to turn camera/recorder on. Press again to turn camera/recorder off.

"POWER" light illuminates when "POWER" ON/OFF button is pressed and camera/recorder is on.

"POWER"/Dew Indicator Light

Flashing of the light indicates dew condensation on camera/recorder mechanism. While this light is flashing, the unit will not operate. If this occurs, eject the tape and leave the power on. When the light stops flashing, the unit can be operated.

"REW" Button

Press this button during stop or fast forward mode, and fast-rewinding starts. "REWIND" indication appears in the viewfinder whenever the tape counter or time remaining is present. Press the button during playback of tape, and the tape is played back in the rewind direction approximately 3 times faster than the normal speed to confirm the recorded contents.

Press "PLAY" button to return to normal playback mode or press "STOP" button to stop tape movement.

NOTE: You can also visually scan backward when the camera/recorder is record/pause (stand-by) mode by pressing and holding this button.

"PLAY" Button

Used for playback of tape recorded in the SP mode.

NOTE: When the camera/recorder is record/pause (stand-by) mode, pressing and holding this button will play the tape at normal.

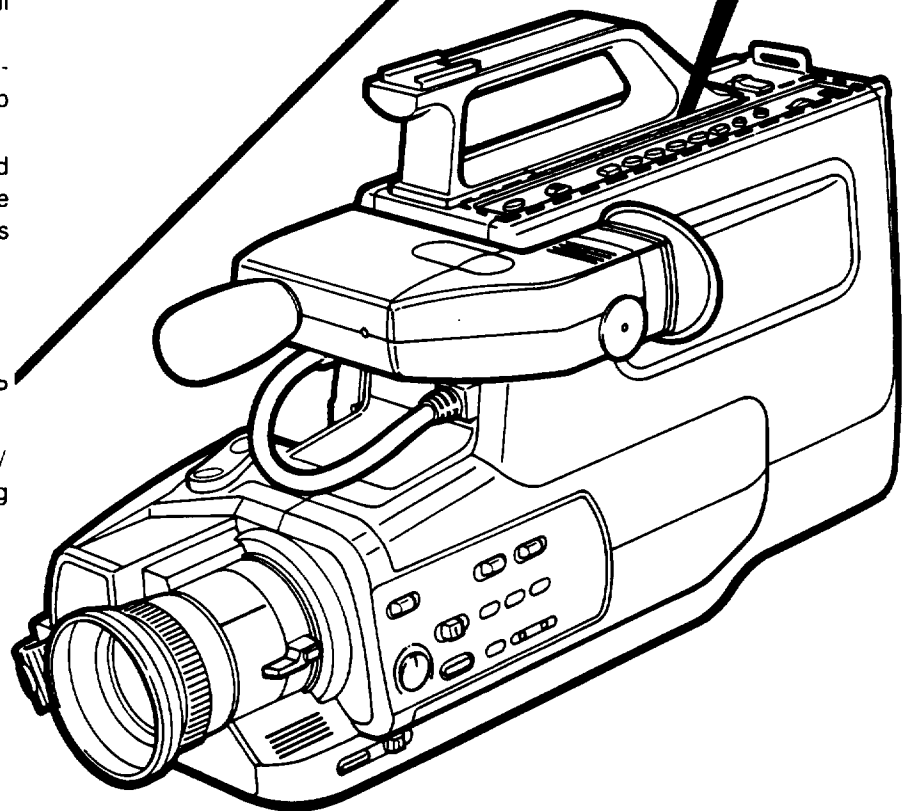
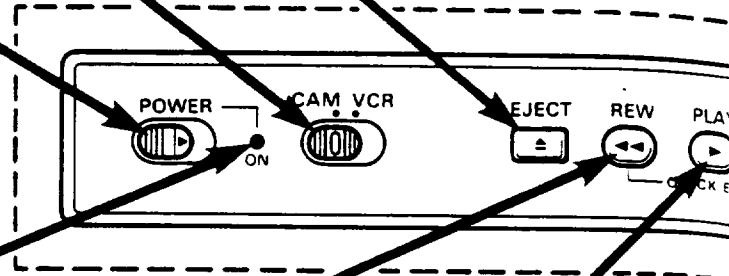

"STOP" Button

The "STOP" button is used to stop playback, rewind, and fast forward operations. The "STOP" button has no effect during record operation.

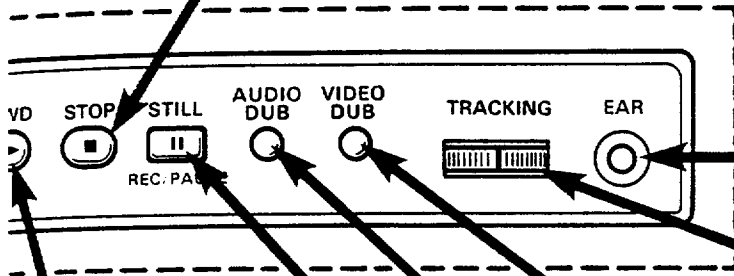

"EAR"phone Jack

Sound being recorded by the microphone or played back may be monitored by attaching earphone (Not supplied) to this jack.

"TRACKING" Control

Used when playing a tape recorded on another VCR. Adjust for best picture. At all other times leave it in the center position, which can be found as a small detent in the movement of the knob.

"VIDEO DUB" Button

This button is used to record new video in place of existing video without erasing the audio. See page 31.

"AUDIO DUB" Button

This button is used to record new audio in place of existing audio without erasing the video. See page 30.

"F.FWD" Button

Press this button during stop or rewind mode, and fast-forwarding starts. "FAST FWD" indication appears in the viewfinder whenever the tape counter or time remaining is present. Press the button during playback of tape, and the tape is played back in the forward direction approximately 3 times faster than the normal speed to confirm the recorded content. Press "PLAY" button to return to normal playback mode or press "STOP" button to stop tape movement.

NOTE: You can also visually scan forward when the camera/recorder is record/pause (stand-by) mode by pressing and holding this button.

"STILL/REC/PAUSE" Button

When this button is pressed during recording, the tape stops and the camera/recorder enters the record/pause (stand-by) mode. When this button is pressed again, the tape runs to resume recording. This button may be also used to display a still picture during playback mode.

Cassette Holder

Press "EJECT" button to open the cassette holder. Be aware of the cassette direction when inserting.

NOTE: Power source must be connected to open the cassette holder.

"DC IN 9.6V" Jack

When using the AC adaptor charger, connect one end of the DC cord (provided) to this jack and the other end to "DC OUTPUT" of the AC adaptor charger. When using the car battery cord (optional), connect this jack and the car's cigarette lighter socket.

"AV OUT" Jack

Connect the AV output cable (Accessory No. 8) to this jack and to the audio and video inputs of your TV/monitor receiver. You may also connect the RF converter unit (Accessory No. 4) to this jack and your TV receiver.

Clock Battery Compartment

Pull the tab to open the cover and install the clock battery (provided).

"MIC MIX (ON/OFF)" Switch

This switch lets you add additional comments (or music) to a tape while you are copying a tape from your camera/recorder onto another VCR.

"SPEAKER" Volume Control

This control lets you increase or decrease the sound level of the built-in earphone speaker.

"AV IN" Jack

Use this connector jack when you want to send signals from another device into your camera/recorder for recording.

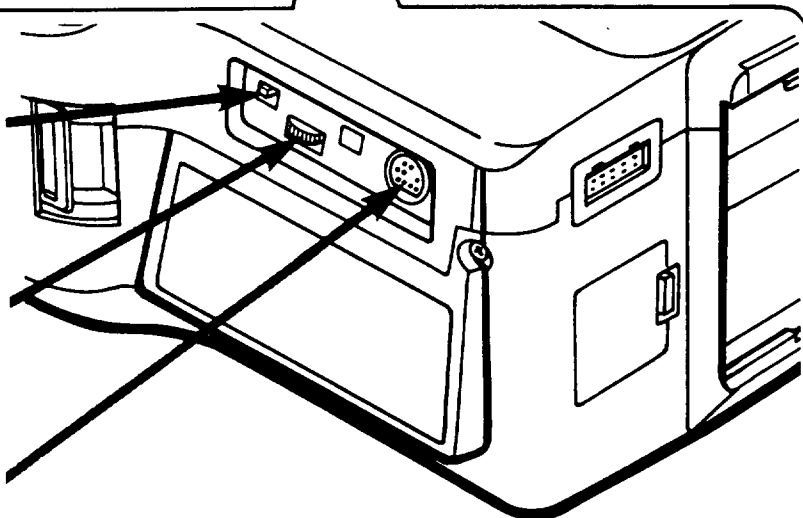
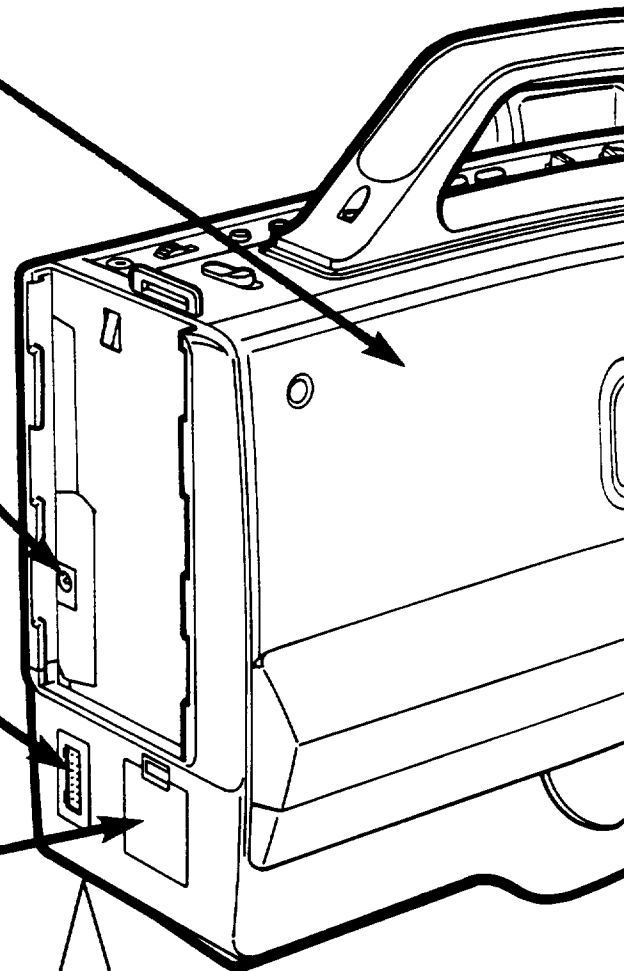

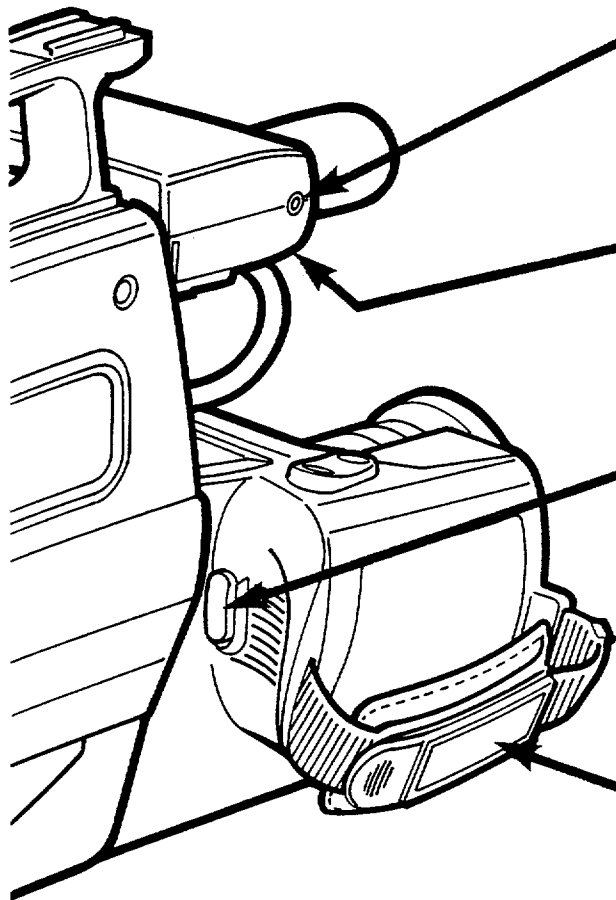

"MIC" Jack

Connect an external microphone (Not supplied) here to record sound from the external microphone.

NOTE: Connecting an external microphone automatically switches off the built-in microphone.

"MIC WIND/NORMAL" Switch

This switch is used to reduce noise that occurs due to wind. Place the switch in the **NORMAL** position for normal use.

Record Start/Stop Button

This button is used to control the camera/recorder. When this button is pressed with the camera/recorder set to the recording mode, the tape runs to start recording. "REC" appears in the viewfinder.

When this button is pressed again, "PAUSE" appears instead of "REC" and the tape stops and the camera/recorder enters the record/pause (stand-by) mode.

Lens Cap Tab

Place the lens cap on this tab when you are ready to record a scene. The tab also prevents the lens cap from swinging around on its cord.

Hand Strap

Adjust to best fit to your hand.

■ **Service Access Door**

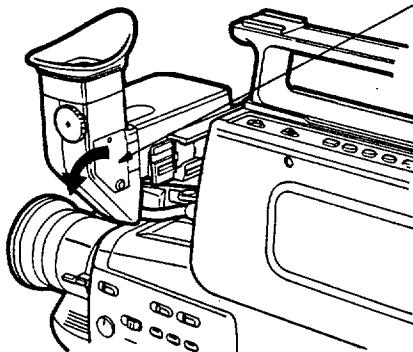

Open to clean picture tube face, mirror and lens. To prevent scratching, use a soft non abrasive cloth, swab or lens cleaning paper.

DATE/CLOCK SETTING

The date and clock can be recorded on your tapes to act as a handy reference when viewing them at a later time. Use the following procedure to set up this display for the current date and time.

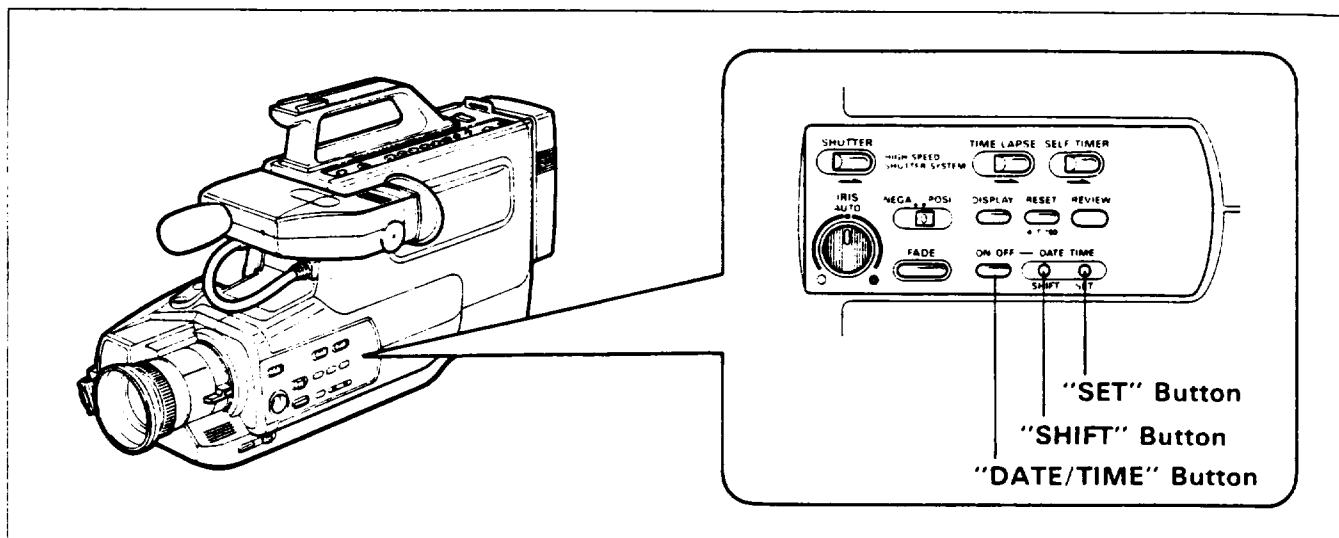

1. Load the camera/recorder's date/clock battery as described on page 7.
2. Turn on power of camera/recorder.
3. Slide "VCR/CAM" select switch to "CAM".
4. Press "DATE/TIME" button.
Date and time appear in the viewfinder and "1" flashes.

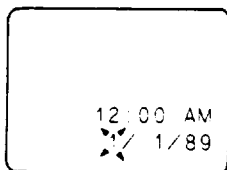

5. Press "SET" button to select correct month. Hold button down to advance rapidly. When the correct month appears, press "SHIFT" button.

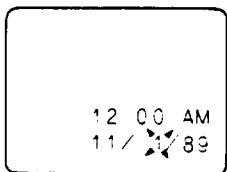

6. Press "SET" button to select correct date. Hold button down to advance rapidly. When the correct date appears, press "SHIFT" button.

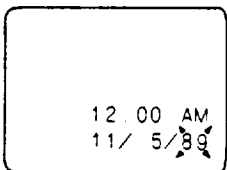

7. Press "SET" button to select year, and then press "SHIFT" button.

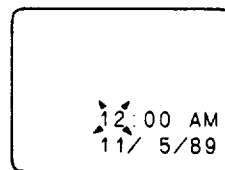

8. Press "SET" button as many times as may be required to select correct hour, and then press "SHIFT" button.
9. Repeat steps 8 to select minute and AM/PM.

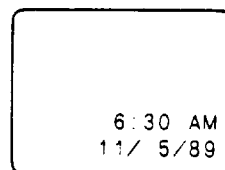

10. After setting AM or PM, press "SHIFT" button again to erase the flashing cursor and start the internal clock.

NOTE:

- To correct date/clock information during programming or after starting the date/clock, press "SHIFT" button until the incorrect digit is flashing. Then use "SET" button to enter the correct digit.
- The date/clock graphics will be recorded whenever they appear in the viewfinder. To display date and clock together, press "DATE/TIME". To display date only, press "DATE/TIME" again. Pressing "DATE/TIME" a third time removes both graphics.

AUTO FOCUS

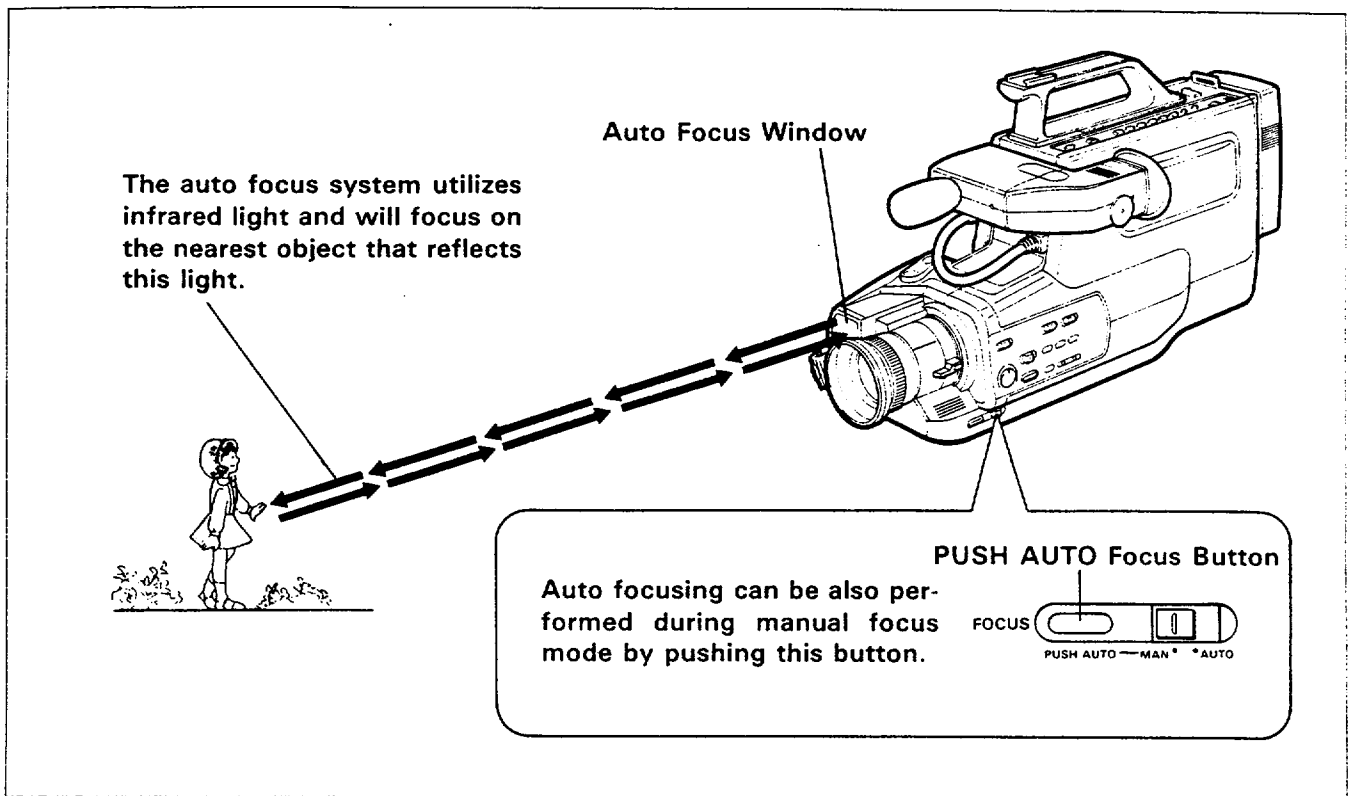

With the "FOCUS AUTO/MAN" switch set to "AUTO" position, ordinary objects are automatically in optimum focus.

■ OBJECTS HARD TO AUTO FOCUS

The distance between the auto focus window and the object is measured, and the focus ring is automatically turned for focusing. However, with the scenes such as shown below, the auto focusing may not operate properly, and manual focus must be performed. See next page.

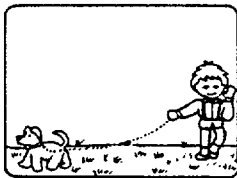

1. Object is not in the center.



2. Object in far and near positions at the same time.

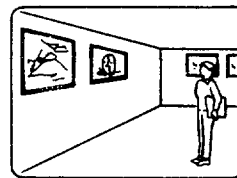

3. Object with continuous variation from far to near positions.

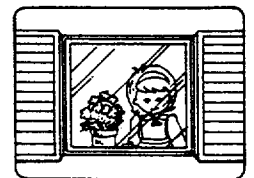

4. Object behind glass.

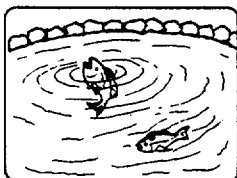

5. Black object or water which does not reflect infrared light.



6. Object always moving such as a crowd.

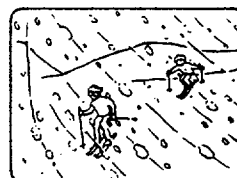

7. Object in the snow or fog.

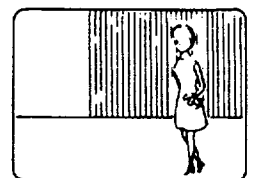

8. Objects with equal pitches.

■ MANUAL FOCUS

1. Set "FOCUS AUTO/MAN" switch to "MAN" position.
2. Zoom in on the object by pressing the power zoom switch on the "T" side.

NOTE: See page 24 for "POWER ZOOM".

3. Focus on the object by turning the focus ring.

NOTE: If focusing is performed without zooming up first, the picture may become out of focus when the zoom-in is done during actual picture taking.

4. Then, zoom out from the object as desired.

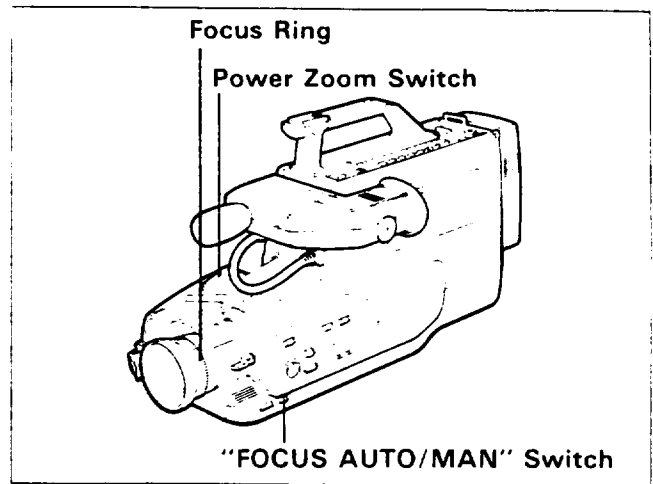

■ MACRO FOCUS

It permits you to shoot objects as close as 1 cm from the lens tip.

1. Set "FOCUS AUTO/MAN" switch to "MAN" position.
2. Turn the zoom lever to "MACRO" while pressing "MACRO" switch.
3. Turn the zoom ring within the "MACRO" range (green line on the zoom ring) for focusing.

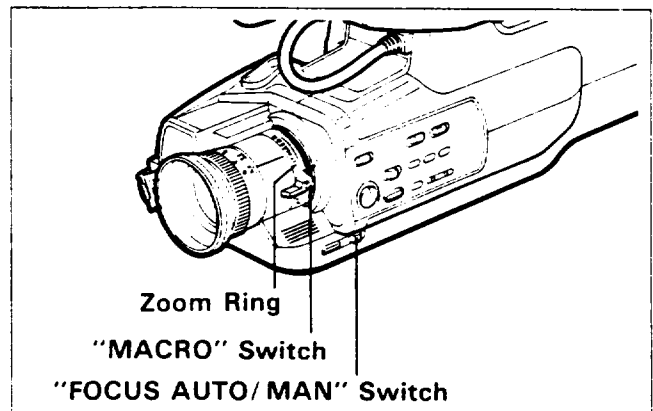

AUTO IRIS

This camera/recorder is provided with an auto iris mechanism which automatically adjusts the lens aperture in accordance with the incident light when the "IRIS" control is placed in AUTO (center) position. When the object is dark, the iris opens automatically, and it closes when the object is bright. When the power is switched off, the iris is automatically set to the fully closed position.

■ To manually adjust the iris

You can also adjust the iris manually.

- When the object is in bright light and the background is dark, adjust the "IRIS" control counterclockwise to narrow the iris opening.
- When the background is in bright light and the object appears to be too dark, adjust "IRIS" control clockwise to widen the iris opening.

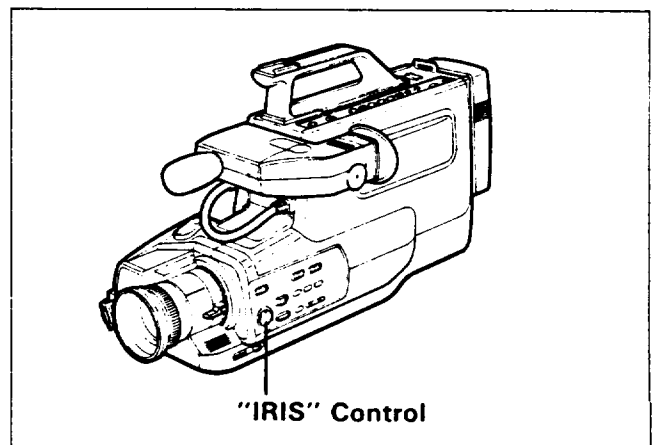

INSTANT REVIEW

1. In record/pause (stand-by) mode, press **"REVIEW"** button, and the recorded scene of the last few seconds is played back in the reverse direction and then played back in the forward direction.

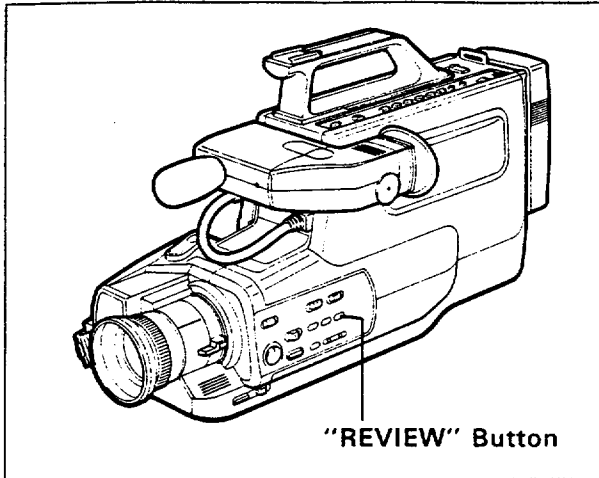

2. When the tape reaches the end of the scene you have just recorded, the camera/recorder returns to the record/pause (stand-by) mode. Recording starts again when the record start/stop button is pressed again.

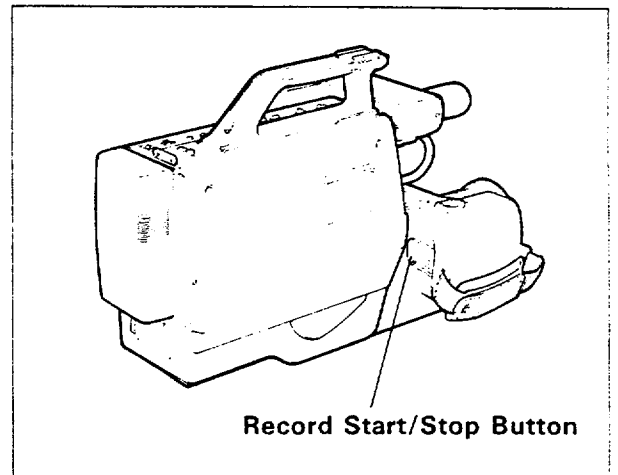

FADE IN FADE OUT

This feature lets you add a professional touch to your home recordings. When you fade into a scene, the recording will start with a blank scene and the picture will gradually appear. The picture gradually disappears when fading out.

■ FADE-IN

1. While the camera/recorder is in the record/pause mode, press and hold **"FADE"** button.
2. Press record start/stop button to start recording.
3. Release **"FADE"** button after a few seconds. The picture will gradually appear on a blank screen.

■ FADE-OUT

1. While the camera/recorder is recording, press and hold **"FADE"** button. The picture will gradually disappear from the screen.
2. Continue to hold **"FADE"** button, and press record start/stop button to stop recording.
3. After the recording has stopped, release **"FADE"** button. The picture will reappear in the viewfinder.

NOTE: When using **"FADE"** button, both picture and sound will gradually appear and disappear. The fade speed is automatically controlled by the camera/recorder.

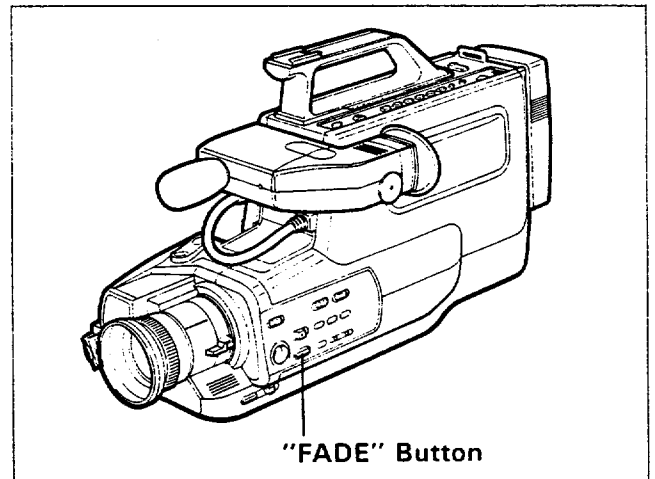

POWER ZOOM

- Press power zoom switch on the "W" side, and the picture gradually widens.



- Press power zoom switch on the "T" side, and the picture gradually becomes telescopic.

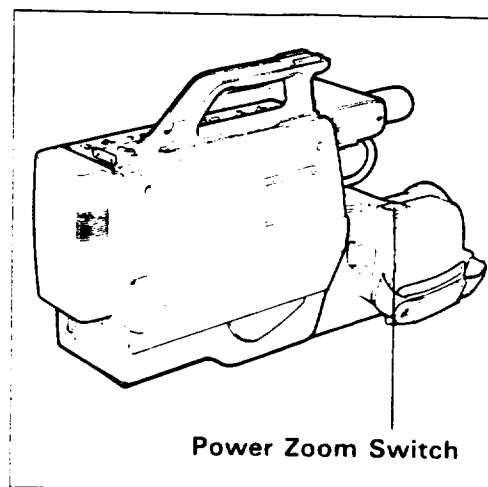

VARIABLE SHUTTER SPEED

Use this feature to shoot tennis and golf shots that contain rapid movement. You can replay the still pictures at the crucial moments without any fluctuations.

Normally the shutter speed is 1/60 seconds. The speed can be changed up to 1/1000 seconds or 1/500 seconds.

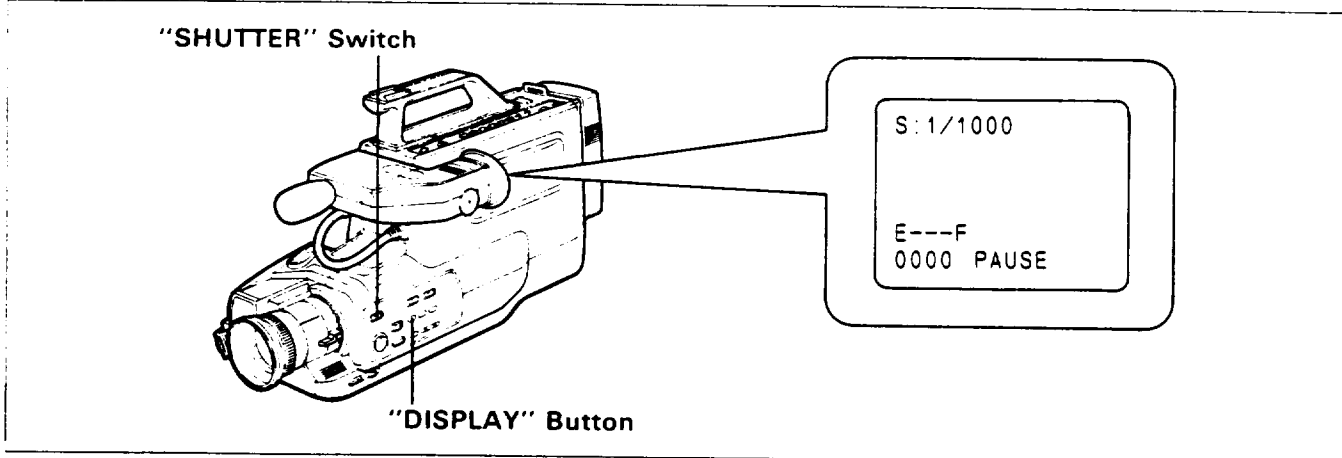

1. In record/pause (stand-by) or record mode, press "DISPLAY" button to display battery level indicator in the viewfinder.
2. Press "SHUTTER" switch once or twice. The shutter speed will change 1/500 or 1/1000 and then back to 1/60 seconds. The shutter speed is displayed in the viewfinder.
For example, the speed is 1/1000 seconds, "S:1/1000" will be displayed.
NOTE: When the shutter speed is 1/60 seconds, "S:1/60" will not be displayed in the viewfinder.
3. Press record start/stop or "STILL (REC/PAUSE)" button to start recording.

NOTES:

- After use, press "SHUTTER" switch so that display of 1/500 or 1/1000 will disappear.
- When shooting at the 1/1000 speed, more light is required because the pictures become darker than the normal shooting at 1/60 speed. When there is insufficient light, the speed indication flashes to warn you.
- When a tape that was recorded using the high speed shutter feature is played back, scenes changes will not be seen as a smooth motion.
- When the camera is pointed at an object that is moving rapidly, it may not be focused in the auto focus mode. In this case, focus manually.
- When you are recording with the 1/500 seconds shutter speed or play back the tape on which recording was made with this shutter speed, the top and bottom of the picture may be lost on some TVs connected to the camera/recorder, but this does not indicate a fault.

DISPLAY BUTTON

Pressing the "DISPLAY" button lets you check several special displays in the viewfinder.

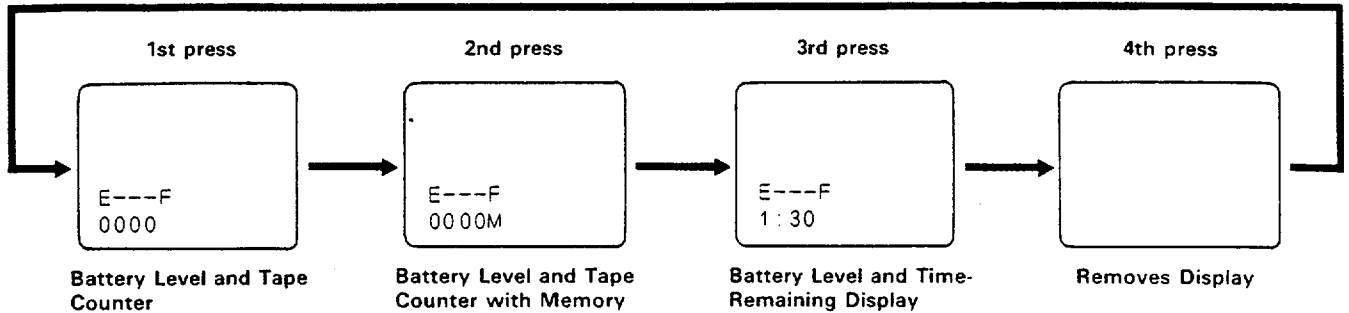

MEMORY

When the tape counter with memory indication appears in the viewfinder, a tape that is being rewind automatically stops when the counter reads approximately "0000". This is useful if there is a section of tape you want to review immediately after recording or if you want to return to the same point several times in a row.

1. Press "DISPLAY" button until the tape counter with memory is displayed.
2. Start playing or recording a tape.
3. At the point you want playback to start, press "RESET/T-160" button to reset the counter to "0000".
4. Continue to play or record.
5. Press "STOP" button.
6. Press "REW" button. The tape will be rewound to the preselected point, at approximately "0000" indication.

NOTE: The tape will also stop approximately at "0000" during fast forward mode.

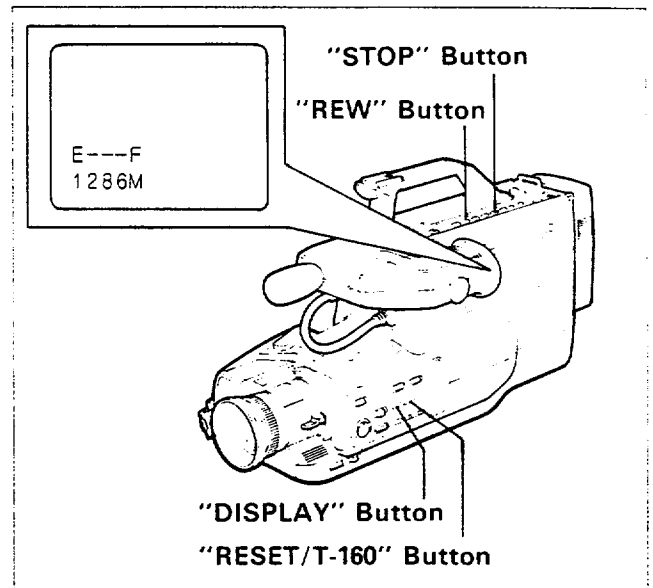

TIME REMAINING

When the tape counter with memory is present in the viewfinder, pressing "DISPLAY" button again will change the display to a read-out showing the amount of recording or playback time left on the tape. Pressing "DISPLAY" button once more clears all graphics from the viewfinder.

NOTE: When using an extended length T-160 cassette, you must press "RESET/T-160" button to adapt the camera/recorder's time remaining system for an accurate read-out. (If the counter is being displayed, "RESET/T-160" button resets the counter to "0000".)

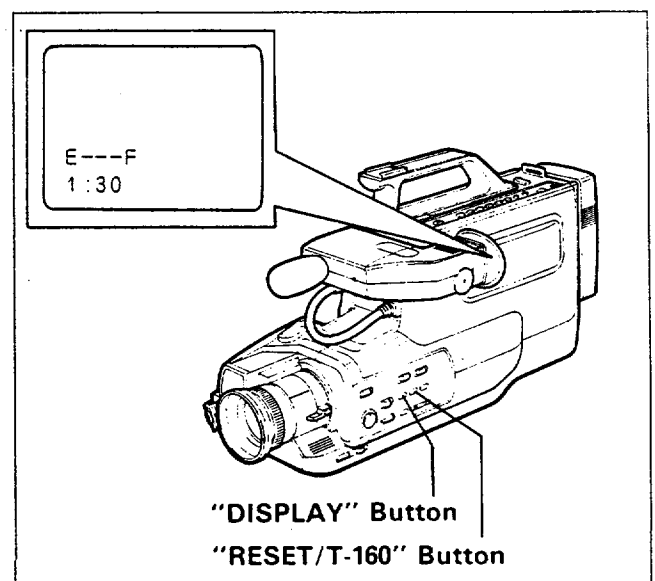

SELF TIMER

The self timer allows you to automatically start recording after about ten seconds.

Press **"SELF TIMER"** switch **once** while in the record/pause mode.

The camera/recorder will automatically start recording after ten seconds when the switch is pressed and will continue to record for approx. 30 seconds.

If you press the **"SELF TIMER"** switch **twice**, the camera/recorder will automatically start recording after ten seconds when the switch is pressed and then recording will continue until the record start/stop button or **"STILL (REC/PAUSE)"** button is pressed.

NOTES:

- Record indicator flashes for about 10 seconds to indicate self timer mode when you press **"SELF TIMER"** switch and stays on during recording.
- Pressing **"SELF TIMER"** switch a third time before recording starts releases the self timer mode.
- To stop the camera/recorder during self timer recording, press record start/stop button or **"STILL (REC/PAUSE)"** button and the camera/recorder will enter the record/pause (stand-by) mode.
- The **"SELF TIMER"** switch has no effect during normal recording.

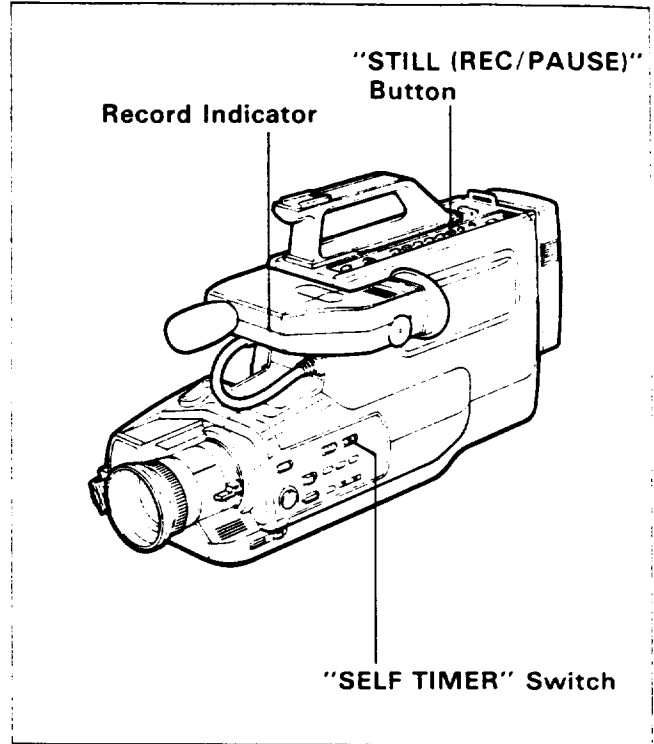

NEGATIVE/POSITIVE INVERSION

You can record a subject while inverting the colors and black/white as in a negative film.

- Normally set to **"POSI"**.
- Set to **"NEGA"** for special effects.



Positive picture



Negative picture

NOTE: Always return the switch to **"POSI"** after shooting with the switch set to **"NEGA"**.

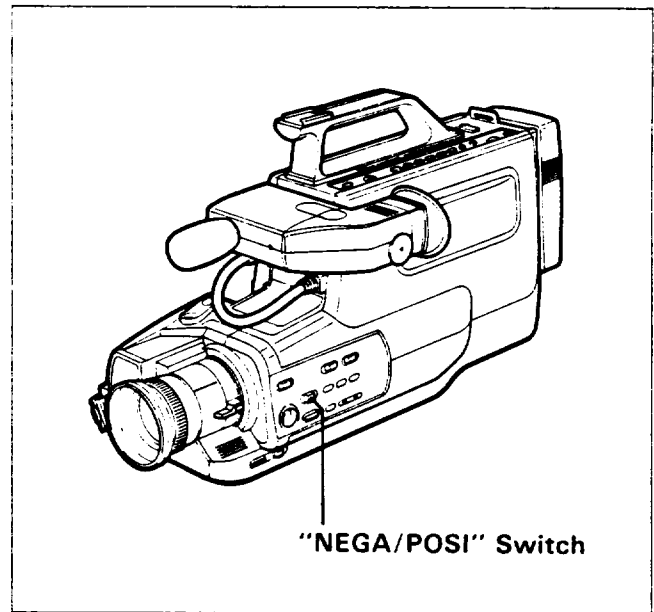

TIME-LAPSE RECORDING

This function is convenient to record the blooming of flowers, etc. as it starts and stops recording at a predetermined interval.

For example, this function allows recording for one second after a pause of 30 seconds and repeats this procedure.

1. In the record/pause (stand-by) mode, press "TIME LAPSE" switch repeatedly until the length of time you want between recordings appears in the viewfinder.
 - The interval is changed from 0:30 (30 seconds) to 1:00 (1 minute), 2:00 (2 minutes), 5:00 (5 minutes), MAN (Manual) and again to 0:30 every time the switch is pressed.

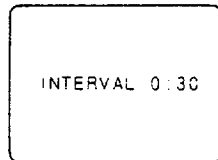

2. Press the record start/stop or "STILL (REC/PAUSE)" button.

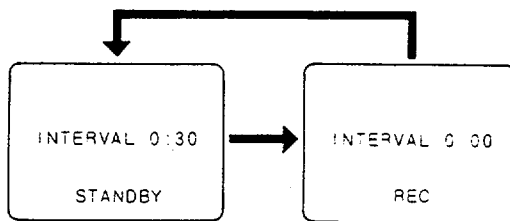

- The clock starts counting, and when it reaches "0:00", a recording is performed for a second, and then the record/pause (stand-by) mode is entered. After 30 seconds, recording is repeated for another second.
3. Press the record start/stop or "STILL (REC/PAUSE)" button to stop recording.

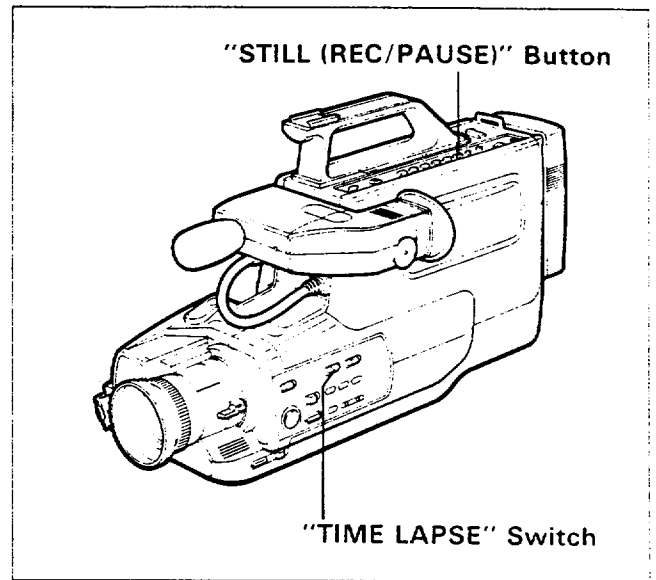

NOTES:

- Do not continue to time-lapse record for more than 48 hours.
- The interval time can be changed any time (even during time-lapse recording) by pressing the "TIME LAPSE" switch.
- If "MAN" is selected for the interval time, one shot recording can be done. See the next page for operations.

ONE SHOT RECORDING

This function is convenient to produce an animated video.

One shot (a few frames) each is recorded every time the record start/stop button is pressed. Shoot a doll, etc. while moving it slightly between shots to produce an animated video of your own.

1. In the record/pause (stand-by) mode, press "TIME LAPSE" switch repeatedly to select "INTERVAL MAN".
2. Press the record start/stop or "STILL (REC/PAUSE)" button.
 - One shot (a few frames) is recorded every time the button is pressed.
3. Press the "TIME LAPSE" switch so that "INTERVAL MAN" disappears to stop recording.

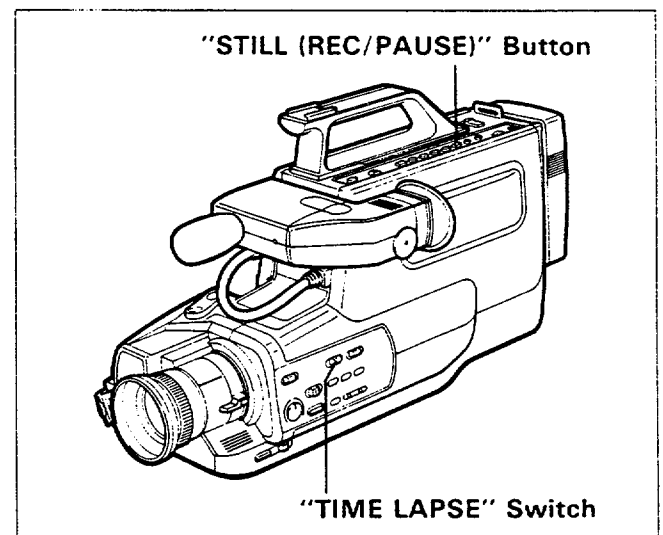

INDEX SIGNAL RECORDING

Indexing your tapes while recording makes it easy to find desired program segments when you play back the tape in a VCR that has a compatible indexing feature called the "VHS Index Search System". See your VCR's instruction manual for index playback instructions.

"INDEX" signals are recorded when the following operations are performed.

- When power is turned on about 4 hours after it is switched off and then recording is started.
- When power is turned on after the date is changed to the next day with the power off and then recording is started.

NOTE: "INDEX" is displayed in the viewfinder, and when an "INDEX" signal is recorded, "INDEX" disappears.

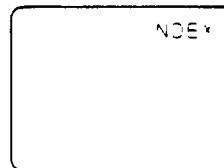

EYEPIECE ADJUSTMENT

To use the electronic viewfinder without eyeglasses on, adjust the diopter control for optimum focus adjustment.

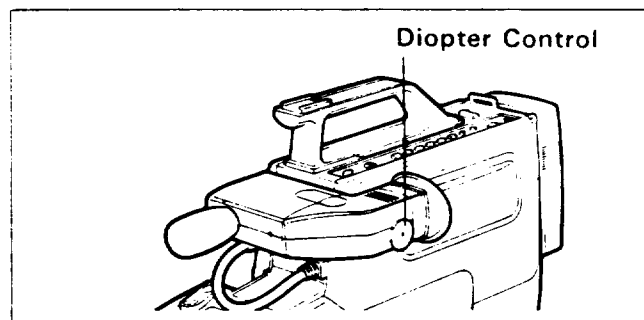

MICROPHONE MIXING

You can mix audio through a microphone during playback.

Connect a source from which you want to mix sound, following the procedure shown on page 30.

NOTE: If no external microphone or equipment is connected, you can mix sound from the built-in microphone.

1. Set the "MIC MIX" switch on the bottom of the camera/recorder to "ON".

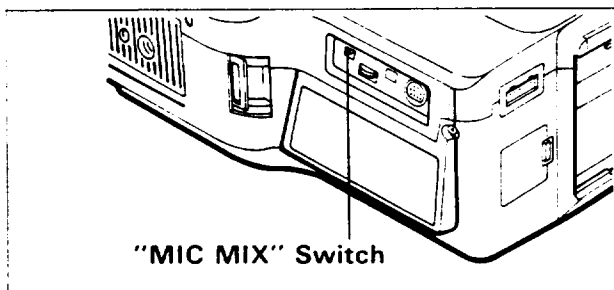

2. Slide "VCR/CAM" select switch to "VCR" position.
3. Press "PLAY" button to play a tape.
 - The picture appears on the TV and sound is output. When you speak to the built-in microphone, your voice is also output from the TV. When external equipment is connected, the sound from it is also output from the TV.

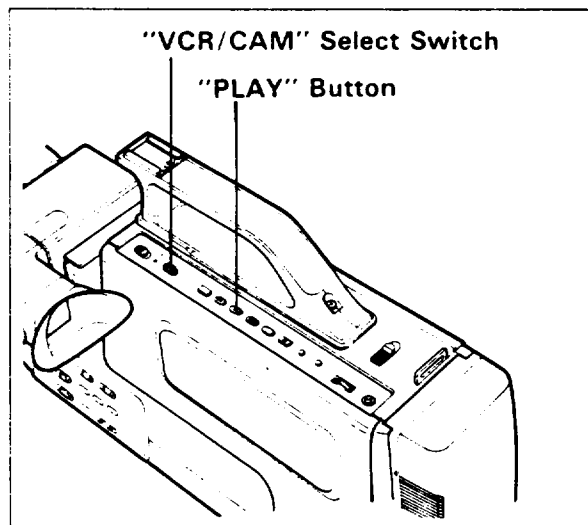

NOTE: If you use this microphone mixing function when copying a tape from the camera/recorder to a VCR, you can copy the mixed sound.

RECORDING TV PROGRAM

If your TV or VCR has an audio/video out jacks, you can record the TV program with camera/recorder.

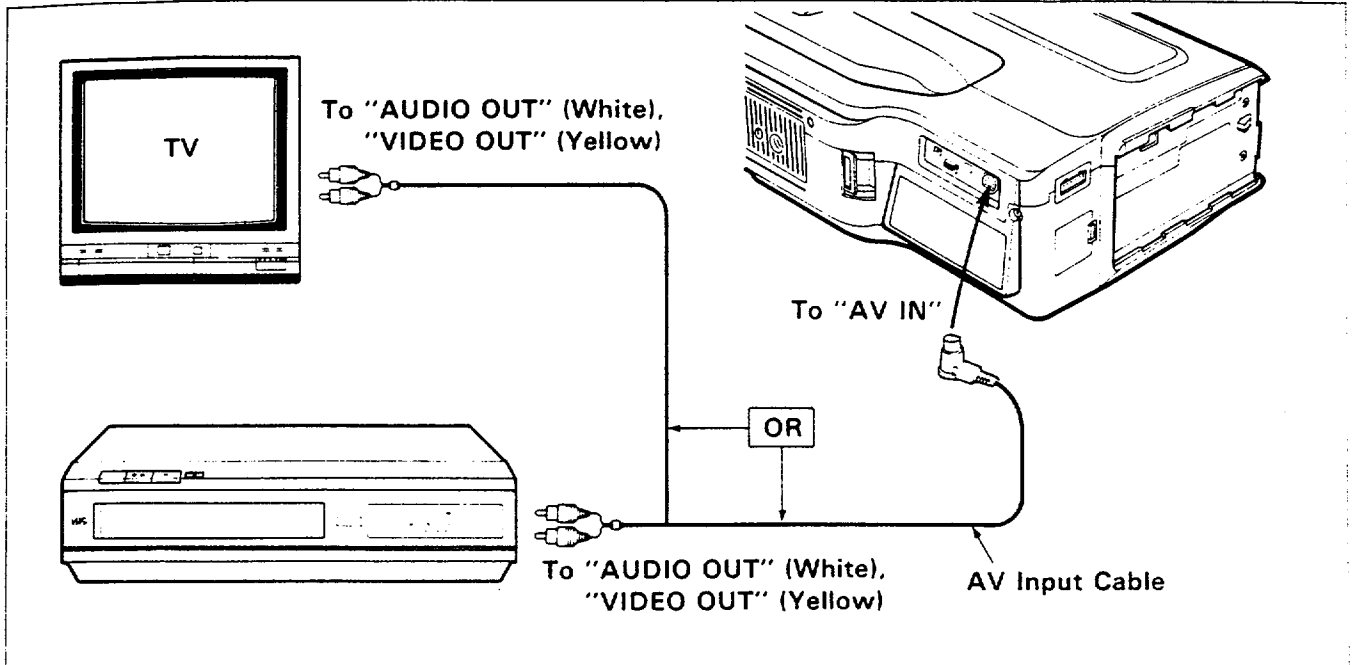

1. Connect the AV input cable to "AUDIO OUT" and "VIDEO OUT" of your TV or VCR.
 2. Connect the other end to "AV IN" of camera/recorder.
 3. Slide "VCR/CAM" select switch to "CAM" position.
 4. Insert the cassette.
- NOTE:** Power source must be connected to the camera/recorder.
5. Turn on power of camera/recorder.

6. Turn on your TV or VCR and tune it to the channel you wish to record.
7. Press record start/stop or "STILL (REC/PAUSE)" button to start recording. You are now recording the TV program.
8. Press record start/stop or "STILL (REC/PAUSE)" button to stop recording.

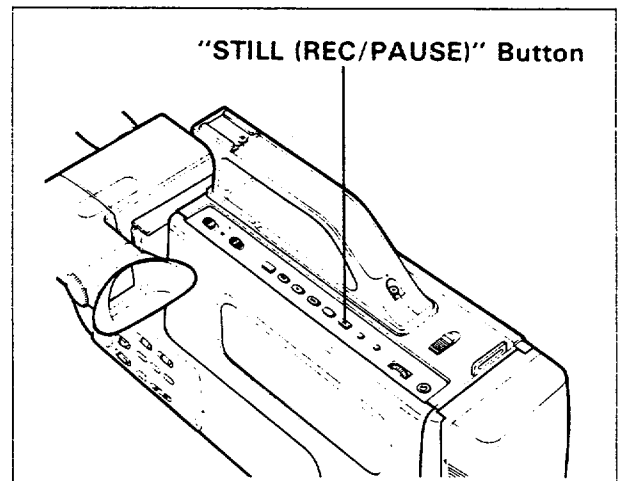
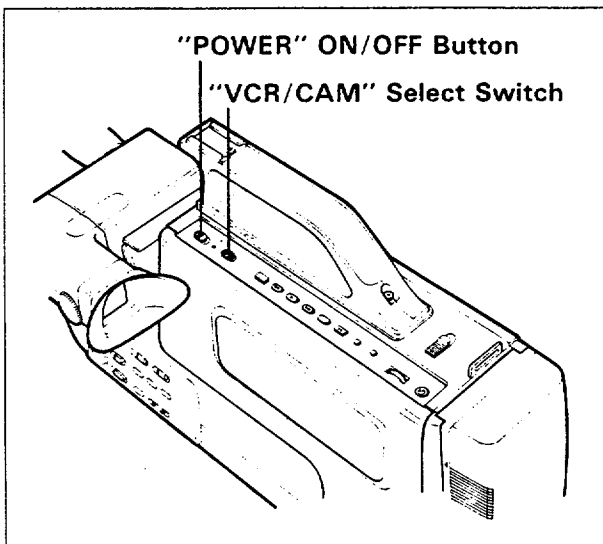

AUDIO DUBBING

The audio dubbing feature lets you record new audio (sound) on a previous recorded tape without erasing the original video (picture).

When you audio dub a tape, the previous audio is erased and replaced with new sound.

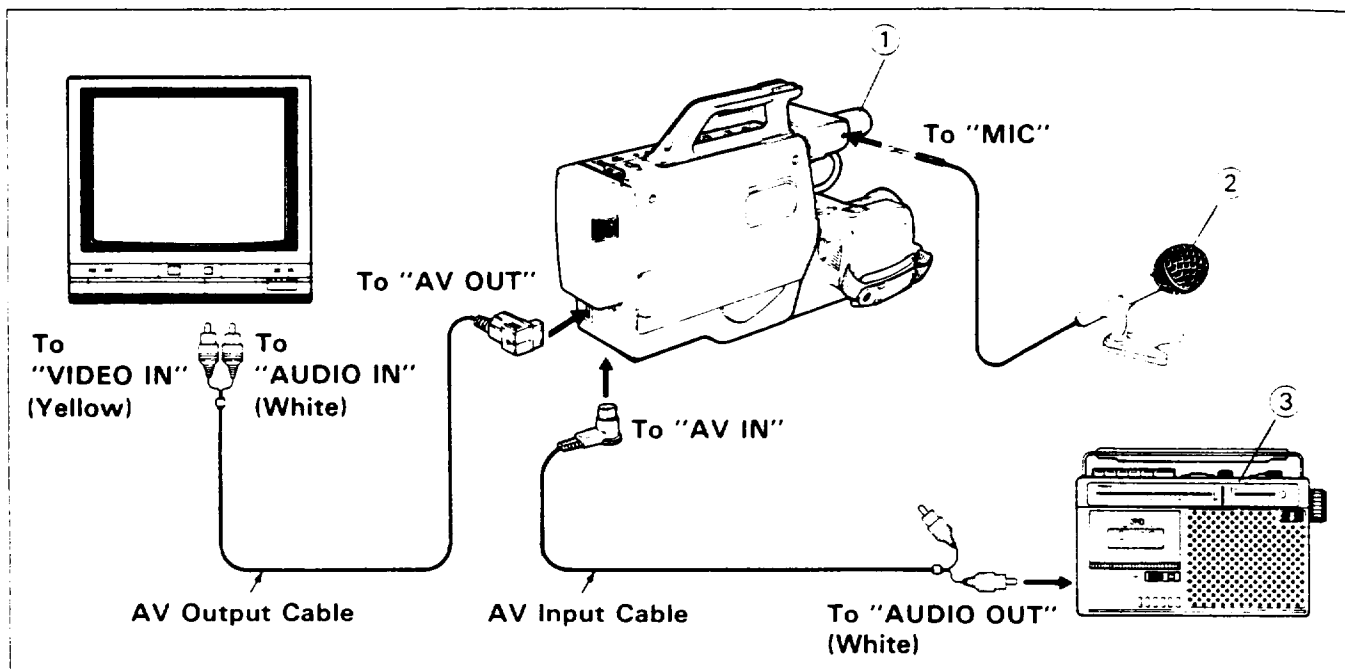

- NOTES:**
- Sound from the built-in microphone, external microphone and the AV IN jack can be dubbed.
 - Do not connect the "AV IN" jack when dubbing audio from the external microphone or built-in microphone. Connecting an external microphone also switches off the built-in microphone automatically.

1. Insert a recorded tape.
Be sure that the record safety tab is not missing.
2. Slide "VCR/CAM" select switch to "VCR".
3. Play the tape and press "STILL (REC/PAUSE)" button where you want to dub audio.
 - The camera/recorder enters the still play mode.
4. Press "AUDIO DUB" and "PLAY" buttons at the same time.
 - "A.DUB" appears in the viewfinder.
5. Press "STILL (REC/PAUSE)" button to start audio dubbing.
6. Press "STOP" button to stop audio dubbing.

NOTE: If counter memory "M" appears in the viewfinder, the tape stops automatically at the reading of "0000" and audio dubbing stops.

NOTE: You can also dub both the video and audio simultaneously if desired. To do so, press "AUDIO DUB" and "PLAY" buttons first, then press "VIDEO DUB" and "PLAY" buttons in step 4 above.

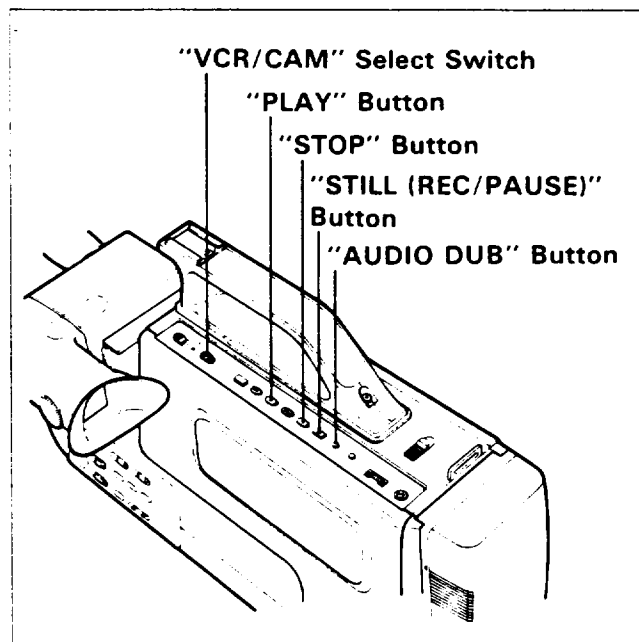

VIDEO DUBBING

The video dubbing feature lets you record new pictures on a previous recorded tape without erasing the original audio (sound).

When you video dub a tape, the previous video is erased and replaced with the new pictures. In video dubbing, the source of the video dub is whatever you are seeing in the viewfinder.

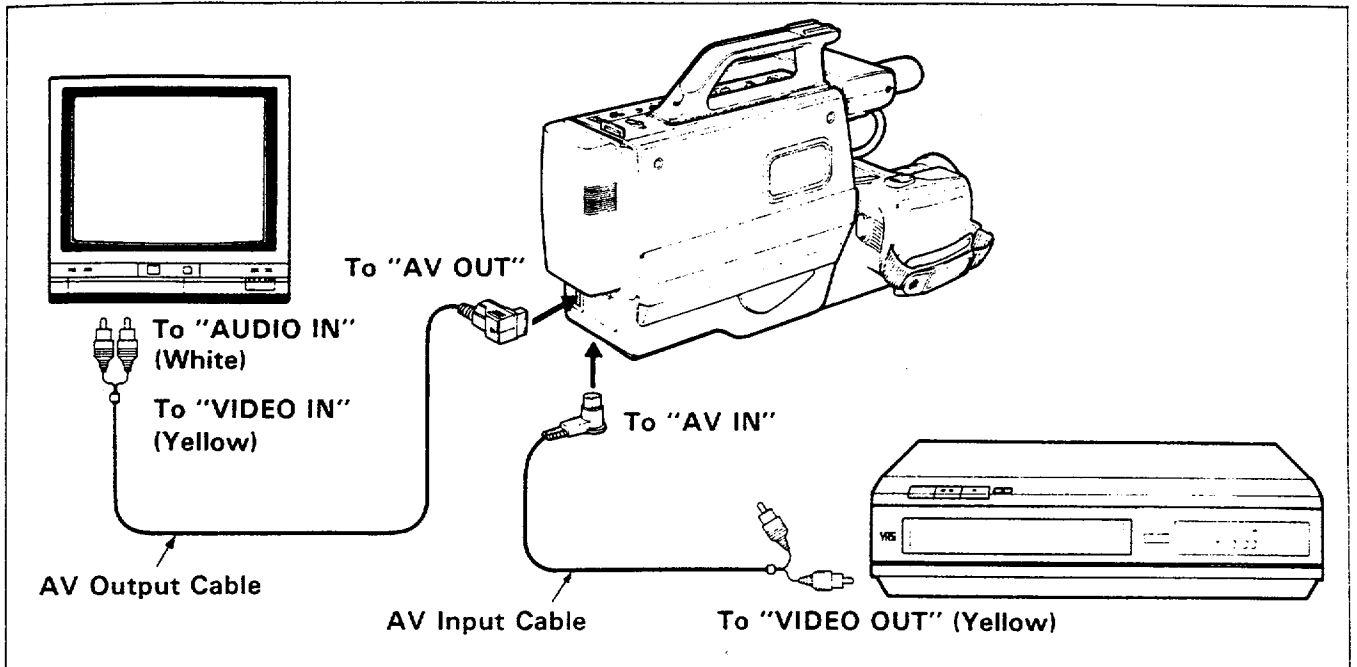

NOTE: The picture shot by the camera/recorder or the picture of a video source connected to the "AV IN" jack can be dubbed.

1. Insert a recorded tape.
Be sure that the record safety tab is not missing.
2. Slide "VCR/CAM" select switch to "VCR".
3. Press "PLAY" button and then "REW" or "F.FWD" button to search to the approximate position of the tape on which you want to dub a picture.
4. Press "PLAY" button again to search the exact position where you stop dubbing and then press "STILL (REC/PAUSE)" button.
5. Press "DISPLAY" button so counter memory "M" appears and then press "RESET/T-160" button to set the counter reading to "0000".
6. Press "REW" button to rewind the tape to the approximate position from which you want to start dubbing.
7. Press "PLAY" button, and when the exact position from which you start to dub is reached, press "STILL (REC/PAUSE)" button.
8. Press "VIDEO DUB" and "PLAY" buttons simultaneously. "V.DUB" is displayed in the viewfinder, and at the same time the picture to be dubbed appears.
9. Press "STILL (REC/PAUSE)" button.
Video dubbing will start and will stop when the counter reads "0000".

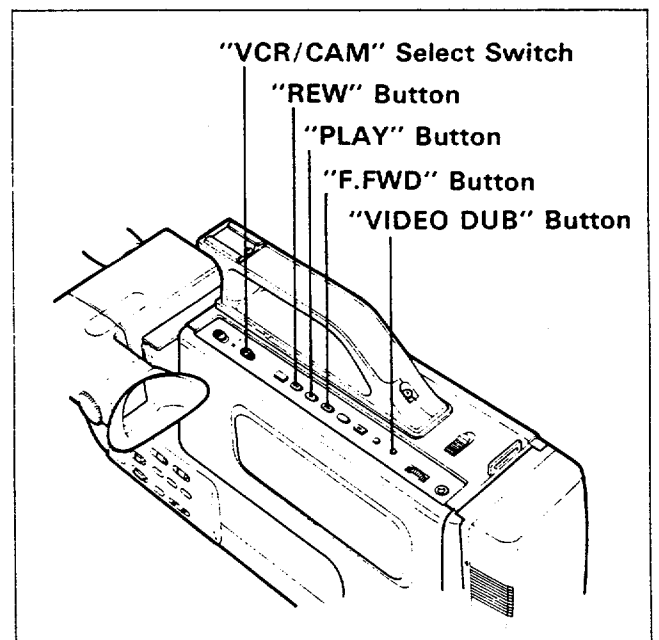

VIEWING THE PICTURE PLAYED BACK ON YOUR TV

To play back a tape recorded on your camera/recorder and view it on your TV receiver, you must connect the camera/recorder to the TV receiver using either AV output cable (Accessory No. 8) or RF converter unit (Accessory No. 4).

You also may play back the tape recorded by your camera/recorder on any other VHS video cassette recorder. The camera/recorder records and plays back in VHS standard speed (SP). A tape recorded in long play (LP) or extra long play (EP) cannot be played back on this camera/recorder.

Example 1: If your TV is a regular TV.

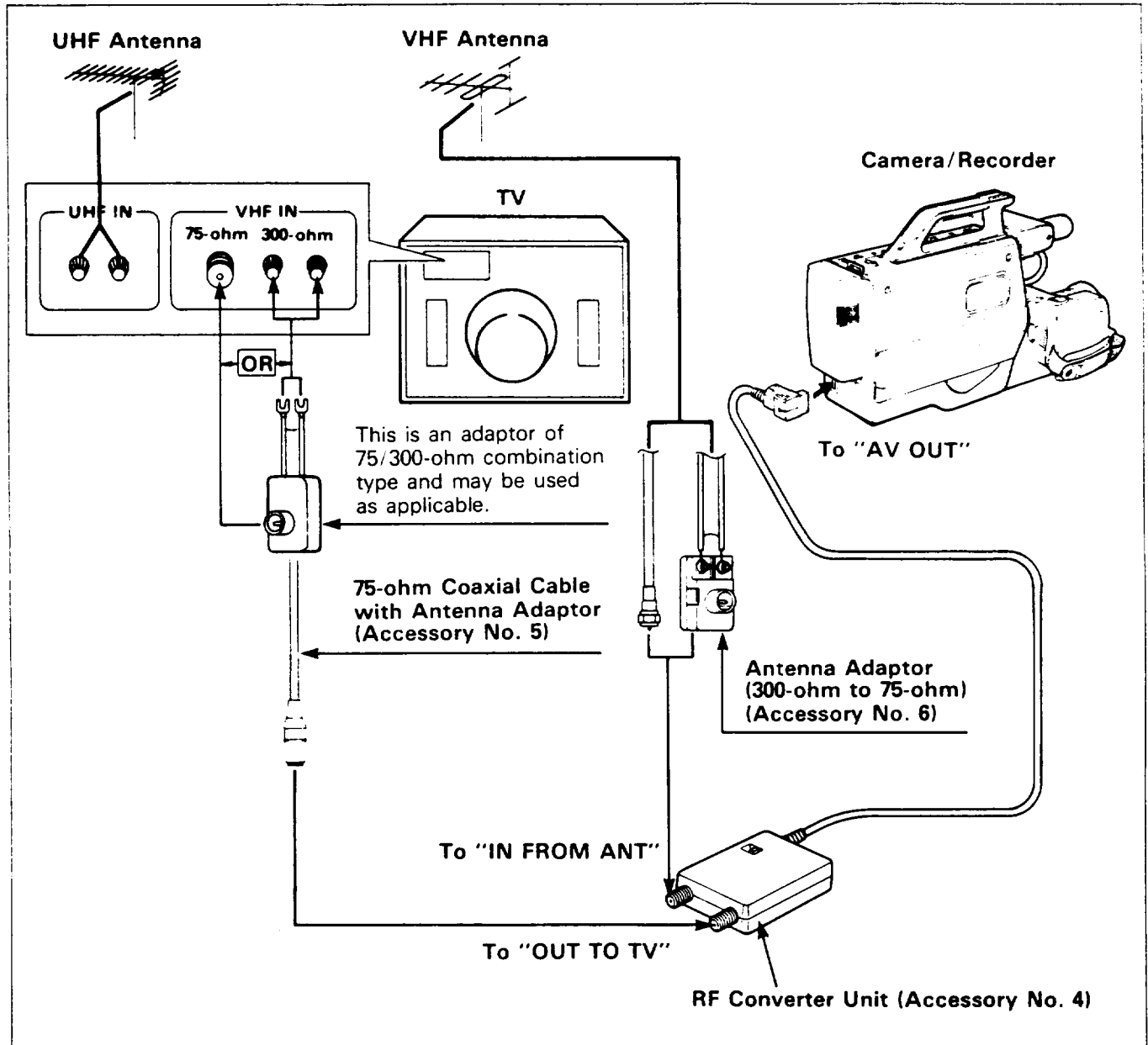

1. Disconnect the VHF antenna leads from the rear of the TV receiver.

NOTE: Leave the UHF antenna leads connected to the TV.

2. Connect the VHF antenna lead to "IN FROM ANT" on the RF converter unit (Accessory No. 4). If the cable is round (75-ohm), it will connect directly to the "IN FROM ANT". If it is the flat type (300-ohm), connect it to the antenna adaptor (300-ohm to 75-ohm) (Accessory No. 6) and slip the adaptor on to the "IN FROM ANT" terminal.

3. Connect the 75-ohm coaxial cable with antenna adaptor (Accessory No. 5) to "OUT TO TV" on the RF converter unit.
4. Connect the other end to the VHF antenna terminal on the TV, as illustrated.
5. Connect the connector cable from RF converter unit to "AV OUT" jack on the camera/recorder.
6. Turn on the TV and set to channel 3 unless channel 3 is one of the TV stations in your area. If channel 3 is used in your area, set your TV to channel 4.
7. Set the RF channel selector on the RF converter unit to "CH3" or "CH4" to match the channel selector on your TV. This is the camera/recorder channel on your TV set. Your TV receiver must be tuned to this channel any time a video cassette is played back on the camera/recorder.

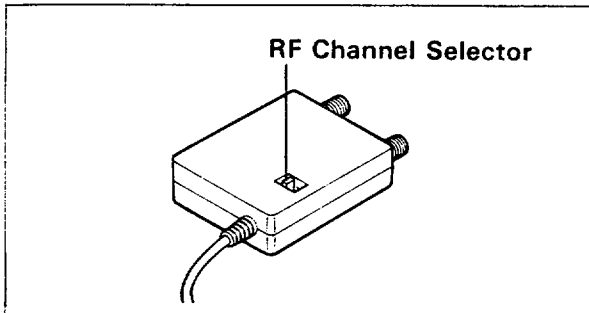

8. Press "EJECT" button on the camera/recorder and then insert the cassette.

9. Slide "VCR/CAM" select switch to "VCR" position.
10. Press "POWER" ON/OFF button on.
11. Press "PLAY" button.
12. After playing press "STOP" button.

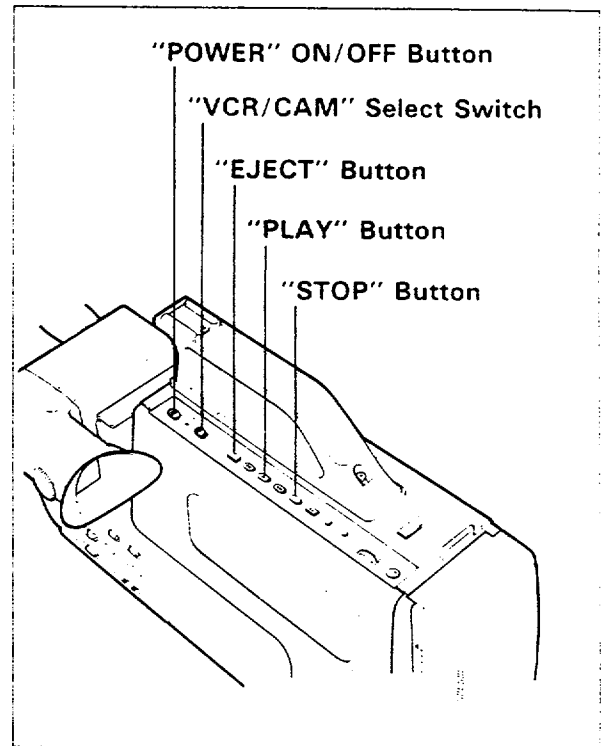

NOTE: If you want to watch a TV program with camera/recorder connected as illustrated, press "POWER" ON/OFF button of the camera/recorder off, or disconnect the connector cable of RF converter unit from "AV OUT" jack on the camera/recorder.

Example 2: If your TV has "VIDEO IN" and "AUDIO IN" jacks.

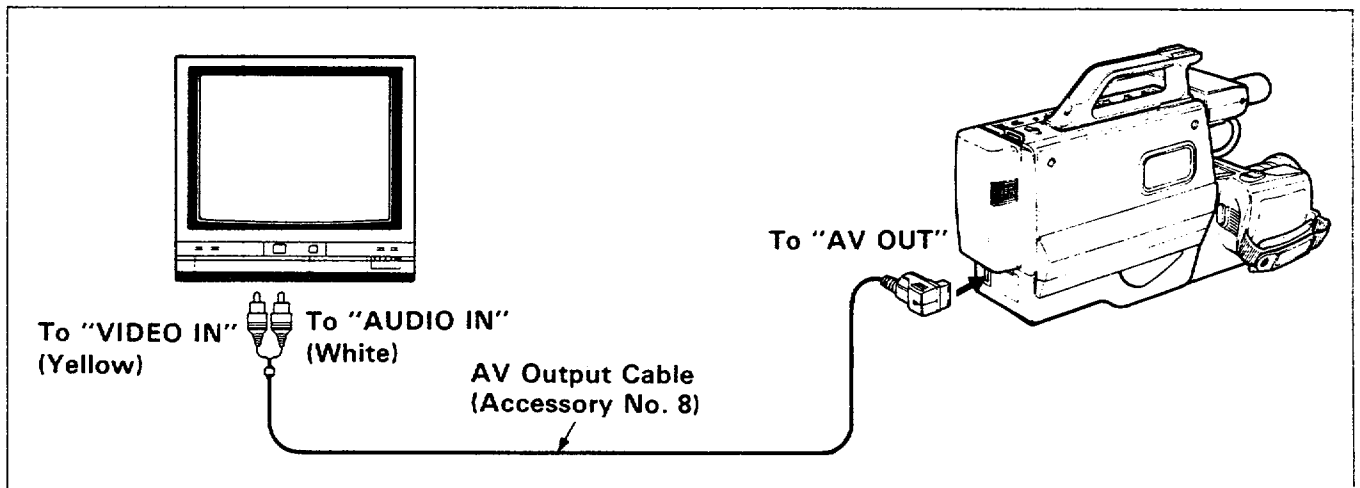

1. Connect the AV output cable (Accessory No. 8) to "AUDIO IN" and "VIDEO IN" of your TV.
2. Connect the other end of the AV output cable to "AV OUT" of your camera/recorder.
3. Turn on TV.
4. Perform same procedures in steps 8 through 12 of "Example 1" above.

Example 3: If you have a VHS VCR,

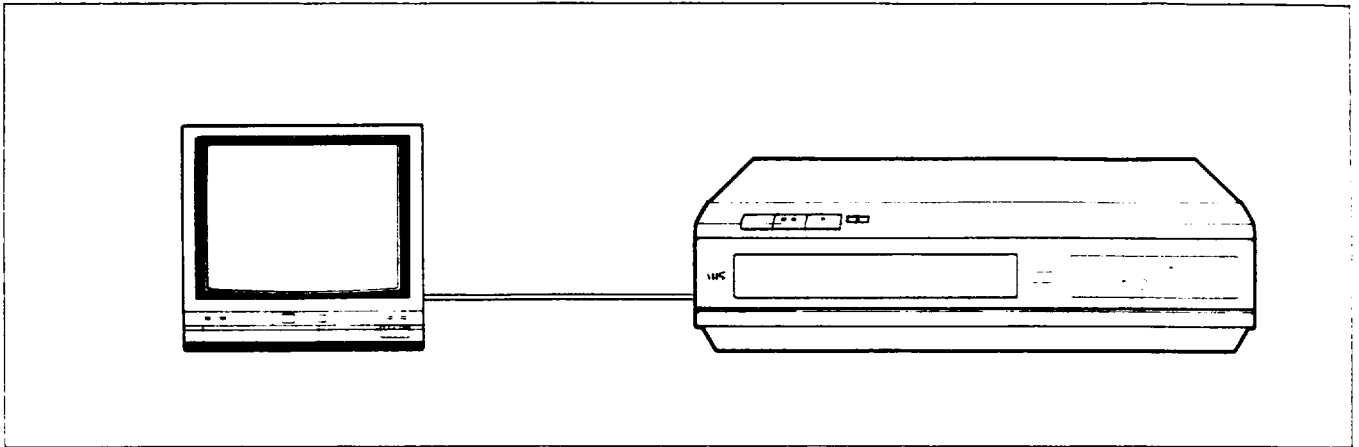

1. Insert the recorded tape into your VCR.
2. Press "PLAY" button of your VCR.

NOTE: When noise appears in the played back picture, adjust "TRACKING" control on the VCR so there is no noise.

STILL

When "STILL (REC/PAUSE)" button is pressed during playback, a still picture can be seen. To start again press "STILL (REC/PAUSE)" button and playback will be resumed.

NOTE: There will be some noise (interference) in the still picture.

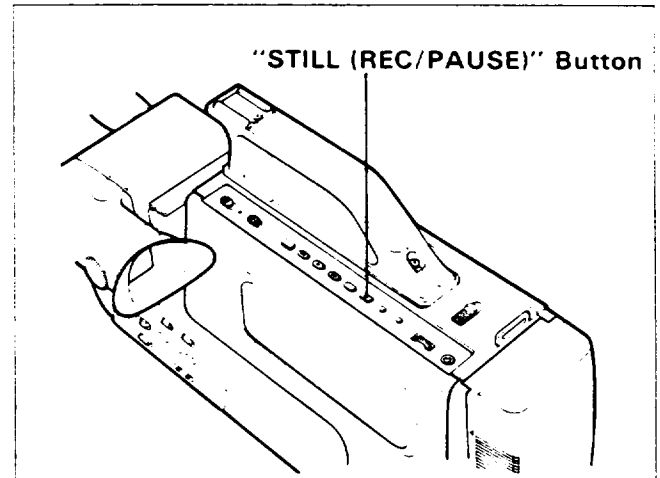

F-SEARCH AND R-SEARCH

When you press "F.FWD" or "REW" button during playback, the tape will be played back at a speed about 3 times faster than the normal playback speed, and you can easily locate a certain spot on the tape.

NOTE: There will be some noise (interference) in the F-search or R-search pictures.

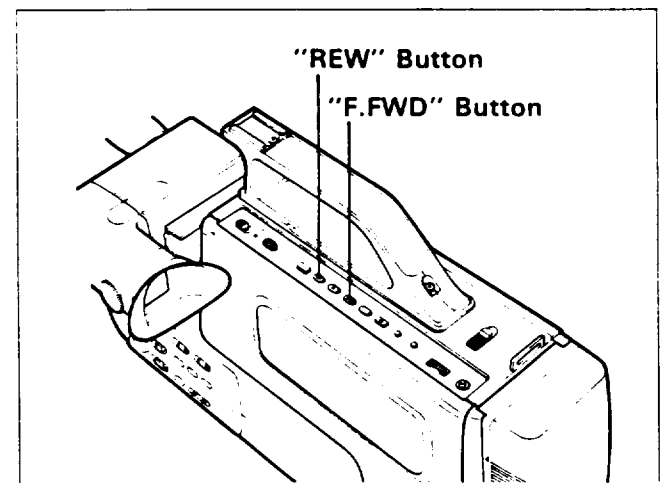
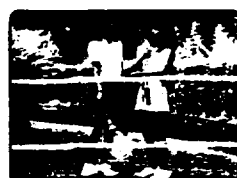

CAMERA/RECORDER TO VCR DUBBING

If you wish to exchange or copy some of your friend's favorite home recordings, the following instructions can be used to connect camera/recorder to VCR for this purpose.

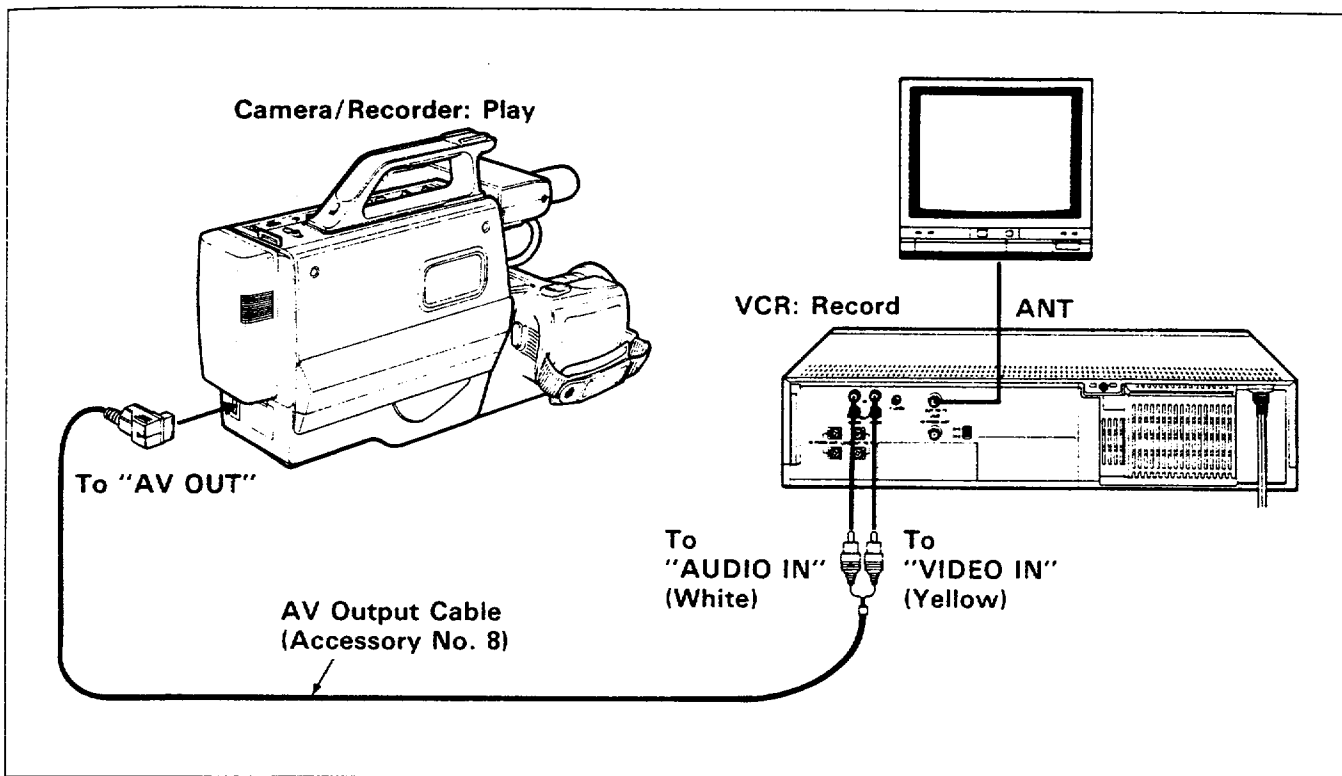

1. Connect the AV output cable to "AV OUT" of your camera/recorder.
2. Connect the other ends to "AUDIO IN", "VIDEO IN" of your VCR respectively.
3. Play the tape on the camera/recorder and record it on the VCR.

NOTE: If you connect the "VHF OUT TO TV" connector of VCR to the "TV ANT" connector, as illustrated and set "VCR/TV" selector of the VCR to "VCR" mode, the picture being dubbed by VCR can be monitored.

EDIT SEARCH

Visual scanning can be performed while "F.FWD" or "REW" button is held depressed in the record/pause (stand-by) mode. And also when "PLAY" button is pressed in the record/pause mode, playback can be done while it is held depressed. Use this feature to search for the end of the previously recorded material in the record/pause mode when you are going to record a new program on the remaining blank section of the tape.

FLYING ERASE HEAD

A rotating erase head eliminates glitches and rainbow noise that occurs at the joints between recordings in previous models.

TROUBLESHOOTING

Your camera/recorder is a highly sophisticated instrument. It has been carefully checked and adjusted at the factory under the most rigid quality control and inspection systems. However, should problems develop, check the following points and take necessary corrective measures.

INSERTING OR REMOVING THE CASSETTE

Symptom	Check Point & Correction
Cassette holder cannot be opened when you press "EJECT" button.	* Connect the power source.
Cassette cannot be inserted into cassette compartment.	* Load cassette in direction indicated by arrow on cassette.
	* Cassette window must be toward outside.

CAMERA RECORDING

Symptom	Check Point & Correction
Picture does not appear in the viewfinder.	* Remove the lens cap.
	* Press "POWER" ON/OFF button on.
	* Set "VCR/CAM" select switch to "CAM" position.
	* Set "IRIS" control to AUTO (center) position.
	* Disconnect the AV input cable from the camera/recorder.
The camera/recorder will not go into the recording mode, even when record start/stop button is pressed.	* The cassette has had the erase prevention tab removed. Stick a piece of cellophane tape over the erase prevention hole or select a different cassette.
	* Set "VCR/CAM" select switch to "CAM" position.
Picture is out of focus. Auto-focus does not operate.	* Set "FOCUS AUTO/MAN" switch to "AUTO".
	* The camera/recorder is set to MACRO mode. Release the MACRO mode, and then focus on the object.
	* Auto-Focus does not operate if the wide conversion or tele conversion lens is attached.

RECORDING TV PROGRAMS OFF THE AIR

Symptom	Check Point & Correction
The camera/recorder will not go into the recording mode, even when record start/stop button is pressed.	* The cassette has had the erase prevention tab removed. Stick a piece of cellophane tape over erase prevention tab hole or select a different cassette.
	* Set "VCR/CAM" select switch to "CAM" position.
	* Connect the camera/recorder and TV (or VCR).

PLAYBACK OF PRE-RECORDED CASSETTE

Symptom	Check Point & Correction
"PLAY" button cannot be engaged.	* Set "VCR/CAM" select switch to "VCR" position.
No picture appears on television screen when "PLAY" button is pressed. (TV is connected to the camera/recorder by using RF converter unit.)	* Set the television to the camera/recorder channel (3 or 4) depending upon the selected channel on the RF channel select switch of RF converter unit.
Interference on playback picture.	* Adjust "TRACKING" control.
	* When you see the playback picture on your TV, adjust fine tuning knob on television set to obtain best picture.
	* The pre-recorded tape is EP or LP recording. This camera/recorder is for use in SP recording only.
Picture bends at the top of TV screen.	* TV receiver is of older type. It needs to be modified to work properly with camera/recorder.
	* Tape is damaged. Try another cassette.
Color of your TV screen is too bright, too faint or change.	* TV set has VIR circuit. Turn it off during playback.

DEW LIGHT

Symptom	Check Point & Correction
"DEW (POWER)" light flashes.	* Condensation on the camera/recorder mechanism – wait until the unit has reached normal room temperature, and condensation has dried. "DEW (POWER)" light will then stop flashing.

BATTERY CONDITION

Symptom	Check Point & Correction
The "E" indication in the electronic viewfinder flashes to indicate battery is discharged.	* Try another battery or charge the battery.

HEAD CLEANING

- Picture playback may become blurred or be interrupted. This does not mean that the recorded program has been erased.
- Dirt accumulated on the head after long periods of use causes this problem. In this case, head cleaning requiring highly technical care is necessary.
- For head cleaning consult the nearest dealer or VCR service center for recommendations.



PERIODIC MAINTENANCE

The video camera/recorder is a precision electromechanical device which will require periodic maintenance after a period of normal use. We expect that no maintenance other than head cleaning will be required during the warranty period by most users, unless the video camera recorder is heavily used or seldom used. Normal maintenance is the responsibility of the user, although defective parts are covered during the warranty period. Consult your VCR service center to determine recommendations for normal maintenance based on your location, use patterns and machine age.

SPECIFICATIONS

■ General

Power requirements	9.6V DC
Power consumption	9.6 watts (When "FOCUS AUTO/MAN" switch to "MAN".)
Dimensions	5"(W) x 9-1/4"(H) x 14-7/8"(D) 127(W) x 235(H) x 378(D) mm
Weight	5.3 lbs (2.4 kg)
Operating temperature	32°F ~ 104°F
Storage temperature	-4°F ~ 122°F



■ Video Recorder Section

Format	VHS
Record/playback system	Two video record/playback heads
Video signal	EIA standard NTSC color
Tape speed	33.35 mm/sec.
Video input	1.0 Vp-p, 75 ohm
Video output	1.0 Vp-p, 75 ohm
Audio input	-7.8 dBs (316 m Vrms), more than 47K ohms
Audio output	-7.8 dBs (316 m Vrms), less than 1K ohm
Fast forward/rewind time	Less than 10 minutes with T-160 cassette

■ Camera Section

Scanning	525 lines/60 fields/30 frames
Required minimum illumination	3 lux
Pickup device	1/2" C.C.D
Lens diameter	46 mm

OPTIONAL ACCESSORIES

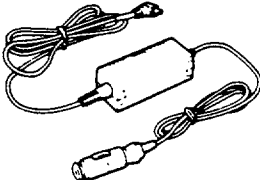
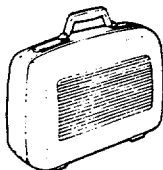
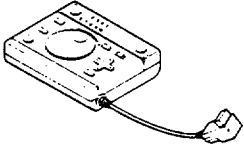
<p>Battery Pack (for standard play) PV-BT71</p>	<p>Battery Pack (for long play) PV-BT72</p>	<p>Car Battery Cord PC-YC77</p>	<p>Carrying Case PV-Z77</p>
			
<p>Character Generator PV-CG900A</p>			
			

PENTAX

PENTAX CORPORATION. 35 Inverness Drive East, Englewood, CO 80112
Service Information: (303)799-8000

PENTAX CORPORATION. 1101 Stewart Ave. Garden City, NY 11530
Service Information: (516)222-0830

PENTAX CORPORATION. 350 East Devon Ave. Itasca, IL 60143
Service Information: (312)250-9000

PENTAX CORPORATION. 8363 Reseda Blvd. Northridge, CA 91324
Service Information: (818)701-5080

PENTAX CORPORATION. 5500 Oakbrook Pkwy, Suite 220 Norcross, GA 30093
Service Information: (404)441-9111

PENTAX CANADA Inc.
3131 Universal Drive, Mississauga, Ontario L4X 2E5
Tel.(416)625-4930

1760 West 3rd Avenue, Vancouver, B.C. V6J 1K5
Tel.(604)733-1161

145 Montée de Liesse, St. Laurent, Québec, H4T 1T9
Tel.(514)739-1715

ASAHI OPTICAL Co., Ltd.
Miyakezaka Bldg., 11-1, Nagata-cho 1-chome, Chiyoda-ku, Tokyo JAPAN
(C.P.O. 895, Tokyo 100-91, JAPAN)
Tel:(03)580-2051

IMPORTANT SAFETY INSTRUCTIONS FOR AC ADAPTOR CHARGER

1. **Save these instructions** — This manual contains important safety and operating instructions for AC Adaptor Charger Model PV-A77A.
2. Before using AC Adaptor Charger, read all instructions and cautionary markings on (1) AC Adaptor Charger, (2) battery and (3) product using battery.
3. **Caution** — To reduce risk of injury, charge only rechargeable battery PV-BT71 or PV-BT72. Other types of batteries may burst causing personal injury and damage.
4. Do not expose charger to rain or snow.
5. Use of an attachment not recommended or sold by the battery charger manufacturer may result in a risk of fire, electric shock, or injury to persons.
6. To reduce risk of damage to electric plug and cord, pull by plug rather than cord when disconnecting charger.
7. Make sure cord is located so that it will not be stepped on, tripped over, or otherwise subjected to damage or stress.
8. An extension cord should not be used unless absolutely necessary. Use of improper extension cord could result in a risk of fire and electric shock. If extension cord must be used, make sure:
 - A. That pins on plug of extension cord are the same number, size, and shape as those of plug on charger.
 - B. That extension cord is properly wired and in good electrical condition; and
 - C. That wire size should be met below:

Minimum AWG size	Length of extension cord (feet)
18	Equal to or less than 100
16	Equal to or less than 150
9. Do not operate charger with damaged cord or plug — replace them immediately.
10. Do not operate charger if it has received a sharp blow, been dropped, or otherwise damaged in any way; take it to a qualified serviceman.
11. Do not disassemble charger; take it to a qualified serviceman when service or repair is required. Incorrect reassembly may result in a risk of electric shock or fire.
12. To reduce risk of electric shock, unplug charger from outlet before attempting any maintenance or cleaning.
13. **Heed Warnings** — All warnings on the appliance and in the operating instructions should be adhered to.
14. **Follow Instructions** — All operating and use instructions should be followed.
15. **Cleaning** — Unplug this video product from the wall outlet before cleaning. Do not use liquid cleaners or aerosol cleaners. Use a damp cloth for cleaning.
16. **Grounding or Polarization** — This video product is equipped with a polarized alternating current line plug (a plug having one blade wider than the other). This plug will fit into the power outlet only one way. This is a safety feature. If you are unable to insert the plug fully into the outlet, try reversing the plug. If the plug should still fail to fit, contact your electrician to replace your obsolete outlet. Do not defeat the safety purpose of the polarized plug.
17. **Overloading** — Do not overload wall outlets and extension cords as this can result in a risk of fire or electric shock.
18. **Object and Liquid Entry** — Never push objects of any kind into this video product through openings as they may touch dangerous voltage points or short-out parts that could result in a fire or electric shock. Never spill liquid of any kind on the video product.
19. **Damage Requiring Service** — Unplug this video product from the wall outlet and refer servicing to qualified service personnel under the following conditions:
 - a. When the power-supply cord or plug is damaged.
 - b. If liquid has been spilled, or objects have fallen into the video product.
 - c. If the video product has been exposed to rain or water.
 - d. If the video product does not operate normally by following the operating instructions. Adjust only those controls that are covered by the operating instructions as an improper adjustment of other controls may result in damage and will often require extensive work by a qualified technician to restore the video product to its normal operation.
 - e. If the video product has been dropped or the cabinet has been damaged.
 - f. When the video product exhibits a distinct change in performance — this indicates a need for service.
20. **Replacement Parts** — When replacement parts are required, be sure the service technician has used replacement parts specified by the manufacturer or have the same characteristics as the original part. Unauthorized substitutions may result in fire, electric shock or other hazards.
21. **Safety Check** — Upon completion of any service or repairs to this video product, ask the service technician to perform safety checks to determine that the video product is in proper operating condition.

WARNING: TO PREVENT FIRE OR SHOCK HAZARD, DO NOT EXPOSE THIS UNIT TO RAIN OR MOISTURE.