

# PENTAX

8mm VIDEO CAMERA/RECORDER

# MODEL PV-C850A

## INSTRUCTION MANUAL

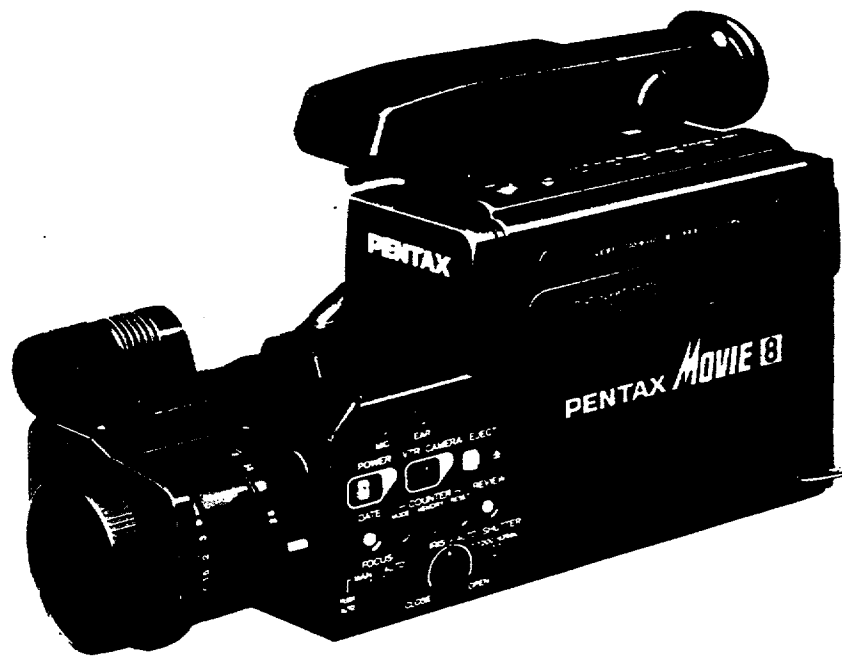

# PENTAX *MOVIE* 8

**WARNING: TO PREVENT FIRE OR SHOCK HAZARD, DO NOT EXPOSE THIS UNIT TO RAIN OR MOISTURE.**



**CAUTION**  
**RISK OF ELECTRIC SHOCK**  
**DO NOT OPEN**



This symbol warns the user that uninsulated voltage within the unit may have sufficient magnitude to cause electric shock. Therefore, it is dangerous to make any kind of contact with any inside part of this unit.

**CAUTION:** TO REDUCE THE RISK OF ELECTRIC SHOCK, DO NOT REMOVE COVER (OR BACK). NO USER - SERVICEABLE PARTS INSIDE. REFER SERVICING TO QUALIFIED SERVICE PERSONNEL.



This symbol alerts the user that important literature concerning the operation and maintenance of this unit has been included. Therefore, it should be read carefully in order to avoid any problems.

## DEW (MOISTURE CONDENSATION)

Moisture condensation may occur if the video camera/recorder is moved from a cold area to a warm humid area. A flashing "POWER" light indicates that moisture is on the recorder mechanism, which could result in damage to the tape. When the "POWER" light is flashing the unit will not operate. In this condition, slide the "EJECT" Button, remove the tape, and wait for the moisture to dry (until the "POWER" indicator stops flashing).

"DEW" ("POWER") Light

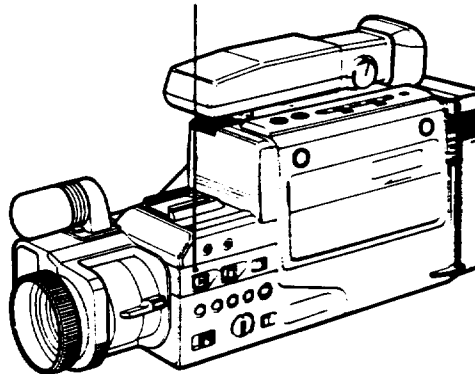

Read the Important Safety Instructions for AC Adaptor/Battery Charge Adaptor before use.

## PRECAUTION

### ■ No water, dust or sand

Be careful that no water, dust or sand enters the Camera/Recorder because it may cause trouble and accidents.

### ■ Never point the lens at the sun or any other strong light.

Do not shoot excessively bright subjects for a long time to prevent damage to the pickup device. When you are not using the Camera/Recorder, switch off its power and attach the lens cap.

### ■ Do not subject to shocks

Do not apply shocks to the end of lens and do not attach a heavy conversion lens as this could cause a malfunction. It is recommended that you use a conversion lens weighing less than 100 g.

### ■ Do not leave the unit where temperatures may exceed 120°F, or the pickup device may be damaged.

- Inside a car with the window closed and in direct sunshine.
- Near heating appliances.
- In direct sunshine in summer.

### ■ Do not hold the unit by the electronic viewfinder or microphone when carrying as this could cause a malfunction.

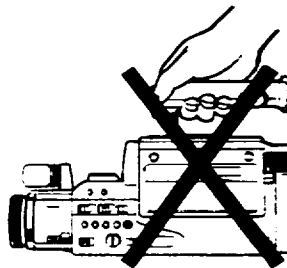

### ■ Close the cover of the A V jack when the RF Converter Unit is not used so that no water or dust can enter the unit.

### ■ When candlelight enters the picture being shot in a dark place, a vertical band of lines may appear.

Congratulations on buying the Video Camera/Recorder. For maximum pleasure and convenience please read these simple instructions before operating your Camera/Recorder.

### RECORDING AND PLAYBACK

- This is an 8mm VTR. Use 8mm video cassettes only.
- Recording speed is 1.43 cm/second (SP).
- You cannot play tapes recorded by other units in the LP mode.
- You may not be able to play certain foreign-made video cassettes on this Video Camera/Recorder because of different TV broadcasting systems. Check to make sure that the cassette tape was recorded on a NTSC system.

**WARNING:** Many television programs are copyrighted. One court has held that private, non-commercial, in-home video taping of copyrighted televised programs constitutes copyright infringement. Purchasers are advised not to copy such programs.

Check to make sure you have the following components and accessories (besides the Camera/Recorder Unit itself) before disposing of the packing material.

1. Adjustment driver
2. RF Converter Unit
3. 75-ohm Coaxial Cable with Antenna Adaptor
4. Antenna Adaptor (300-ohm to 75-ohm)
5. Battery Pack (1 hour type)
6. AC Adaptor
7. Battery Charge Adaptor
8. Battery for clock/date
9. Earphone
10. Shoulder Strap

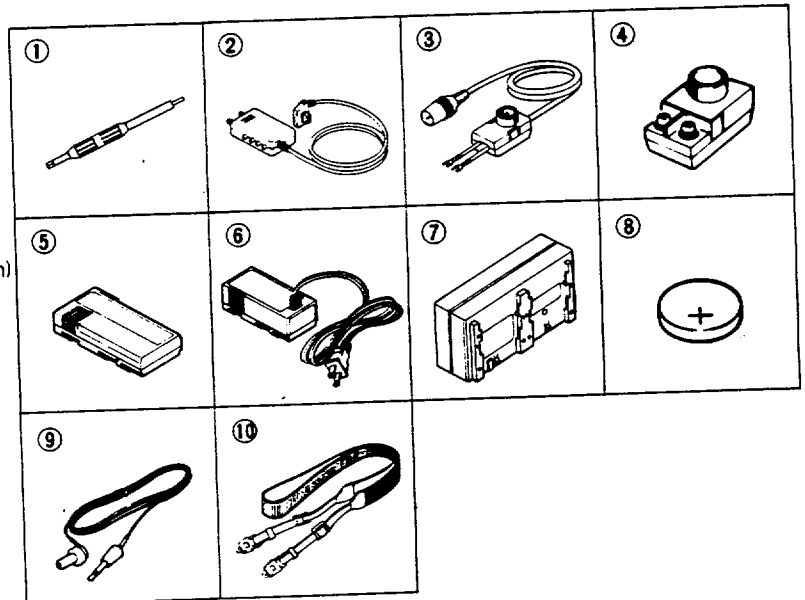

## TABLE OF CONTENTS

Before using .....	4
8mm video cassette .....	5
Power sources .....	5
Checking the battery pack .....	7
Charging the battery pack .....	7
Identification and operation of controls .....	8
Recording with camera .....	14
Using the auto focus feature .....	16
Using the auto iris feature .....	17
Using the fade-in/fade-out feature .....	18
Using the high speed shutter feature .....	18
Using the power zoom feature .....	19
Using the macro feature .....	19
Using the instant review feature .....	19
Using the date recording feature .....	20

Producing best color program .....	21
Connections and operations for viewing the picture played back on your TV .....	22
Connections and operations for recording TV program .....	24
Using the pause and frame advance feature .....	25
Using the slow feature .....	26
Using the F-search and R-search features .....	26
Using the memory feature .....	26
Using the time remaining feature .....	27
Tape dubbing .....	27
Using the insert recording feature .....	28
Head cleaning .....	29
Periodic maintenance .....	29
Specifications .....	29
Troubleshooting .....	30
Optional accessories .....	32

# BEFORE USING

## LOADING THE BATTERY FOR CLOCK/DATE

Slide the Battery Cover upward while pressing triangular mark ▲ on the cover to open the Battery Compartment. Insert the clock battery (Accessory No. 8) with the "+" terminal facing out. See page 20 for instructions on setting the clock.

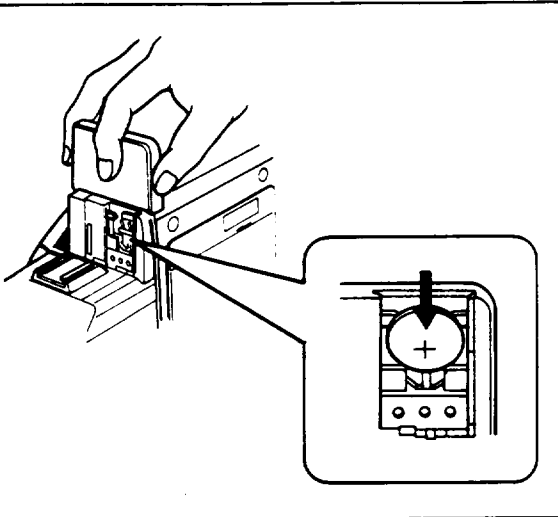

Press the section shown by the arrow to remove the battery.

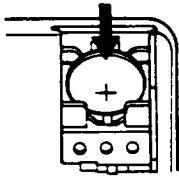

**NOTE:** When replacing the battery, use 3-Volt Lithium Battery (CR2025 or equivalent).

## INSTALLING THE SHOULDER STRAP

Attach the Shoulder Strap (Accessory No. 10) as illustrated below.

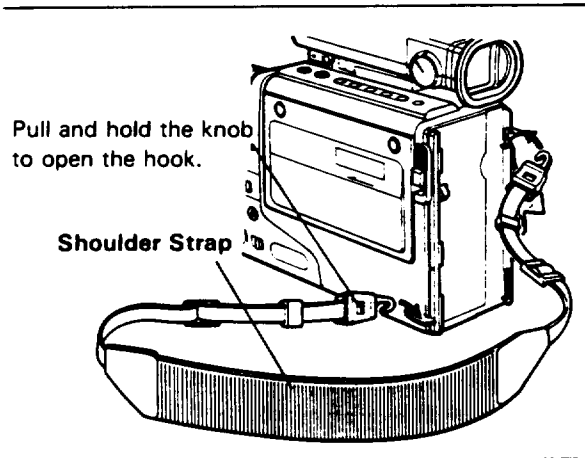

Pull and hold the knob to open the hook.

## EYEPiece ADJUSTMENT

If you wear eyeglasses, you can remove them and still operate the Camera/Recorder.

To sight through the electronic viewfinder without eyeglasses, use the Eyepiece Control (shown) to adjust viewfinder focus. This will not affect the focus of the image recorded by the Camera/Recorder.

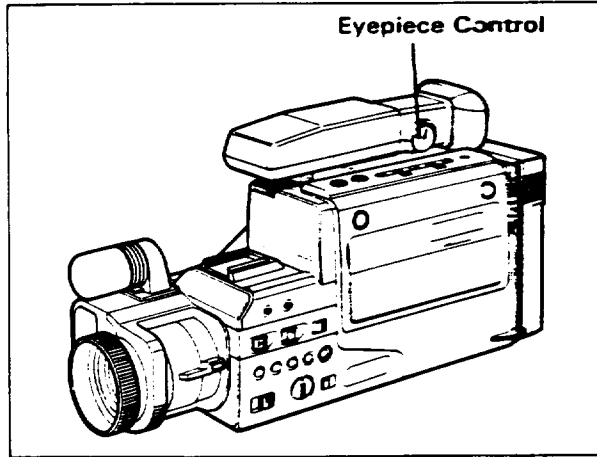

## POSITION AND ANGLE ADJUSTMENTS OF ELECTRONIC VIEWFINDER (EVF)

You can move the viewfinder backward or forward. After moving, depress it until a click sound is heard.

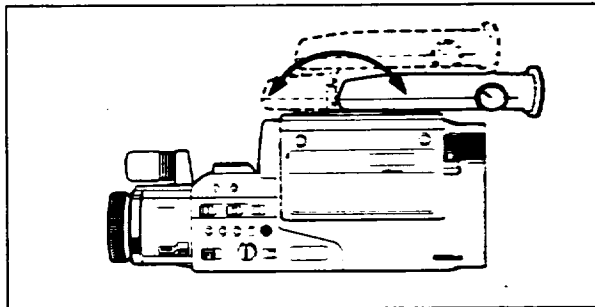

For convenient viewing, the EVF can be tilted about 110° up.

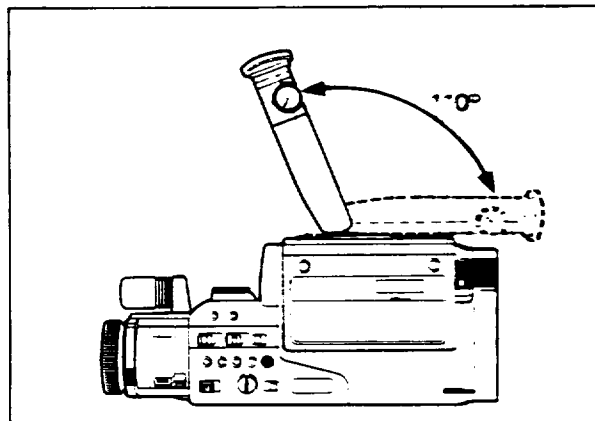

## 8MM VIDEO CASSETTE

The 8 mm Video Cassette has a Safety Tab on the bottom of the cassette that can be adjusted to prevent accidental erasure of recorded material.

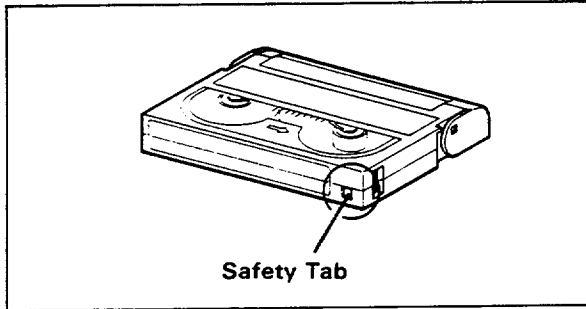

To prevent accidental erasure, slide the Safety Tab in the direction of arrow until the red Safety Tab is completely visible.

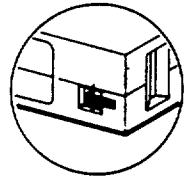

To record again on the cassette, slide the Safety Tab in the direction of arrow. The red Safety Tab will disappear behind the cassette case.

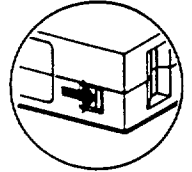

## POWER SOURCES

### ■ WHEN USING THE BATTERY PACK (Accessory No. 5)

1. Move the EVF forward.

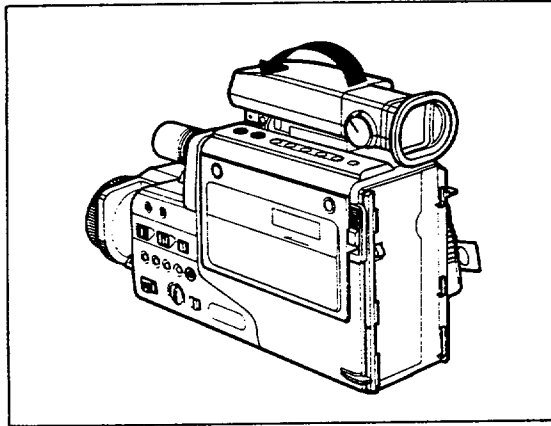

3. For removal, slide the Battery Pack upward while holding the Battery Release Lever downward.

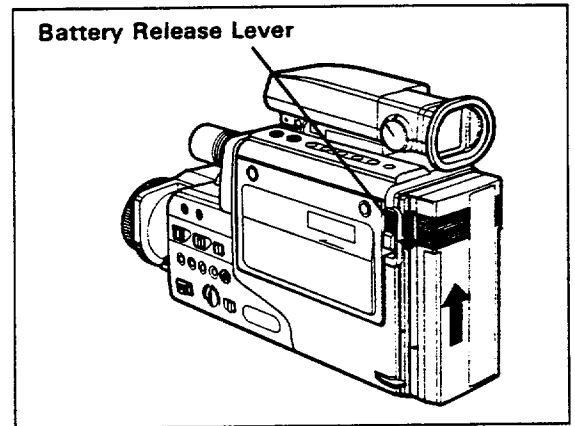

2. For attachment align the mark ► on the side of the Battery Pack with that on the side of the Video Camera/Recorder so that they are joined together in the grooves, and slide the Battery Pack downward, as illustrated.

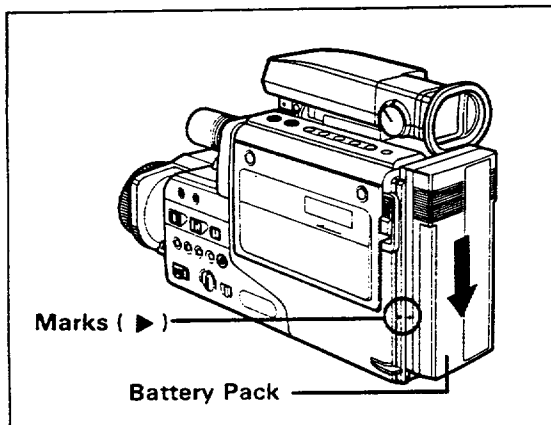

■ **WHEN USING WITH THE AC ADAPTOR (Accessory No. 6)**

1. Move the EVF forward.

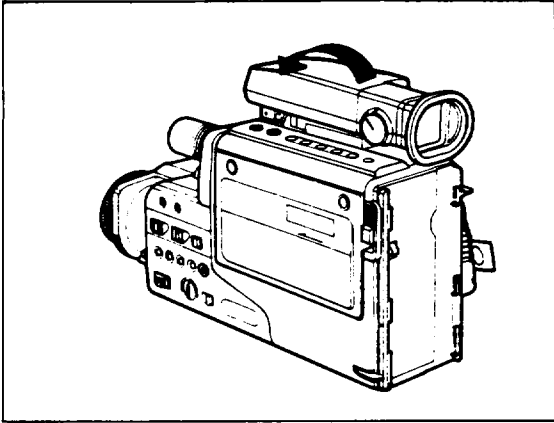

2. For attachment align the mark ► on the side of the AC Adaptor with that on the side of the Video Camera/Recorder so that they are joined together in the grooves, and slide the AC Adaptor downward as illustrated.

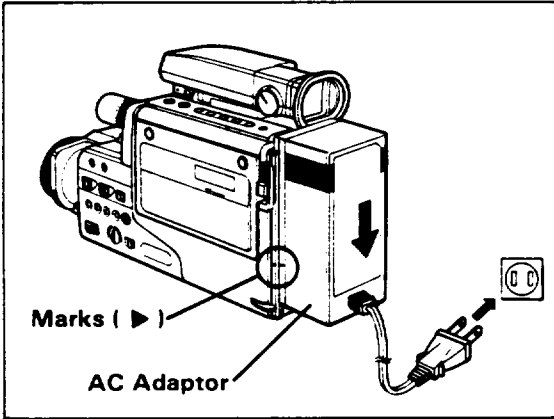

3. Plug the AC Adaptor power cord into AC electrical outlet.

**NOTE:** This Adaptor is universal for use with AC 100 – 240V around the world.

4. For removal, slide the AC Adaptor upward while holding the Battery Release Lever downward.

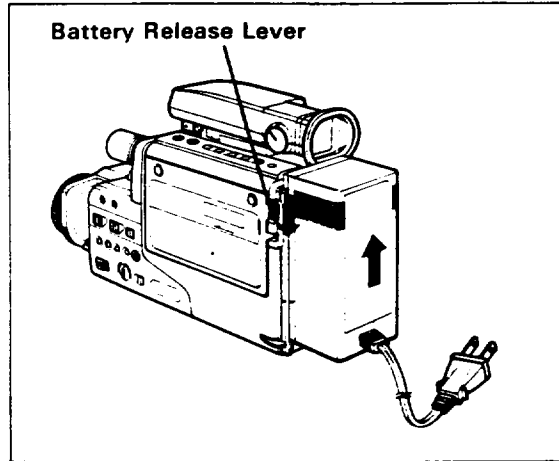

■ **WHEN USING WITH THE CAR BATTERY (By using optional Car Battery Adaptor PV-YC800A manufactured by PENTAX Corporation.)**

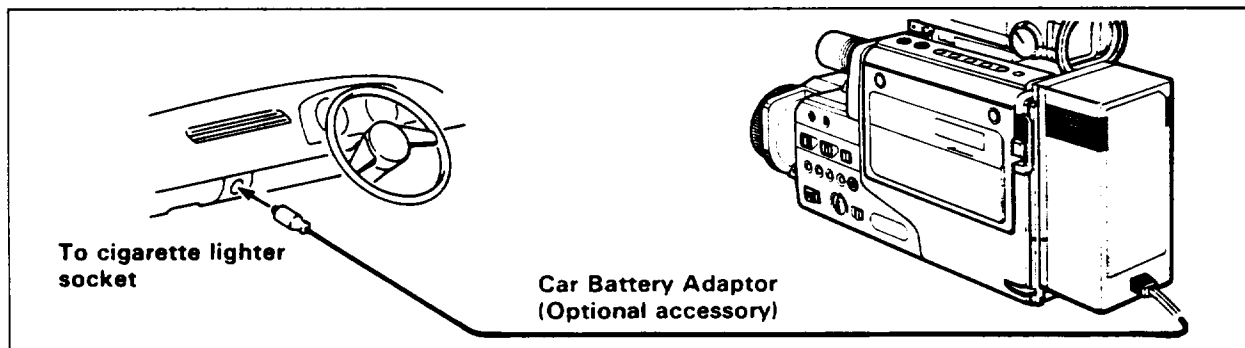

Connect the optional Car Battery Adaptor to the Video Camera/Recorder and its cord to the car's cigarette lighter socket. See "WHEN USING WITH THE AC ADAPTOR" for Car Battery Adaptor installation and removal.

**NOTE:** The Car Battery Adaptor is designed to be used only with automobiles having a 12-24-volt negative ground system.

## CHECKING THE BATTERY PACK

When the Indicator Lamp (RED) in the Electronic Viewfinder flashes while the Video Camera/Recorder is operated with a Battery Pack (Accessory No. 5), it indicates that the battery capacity is insufficient. Then, charge it or replace it with a charged battery pack.

**NOTE:** Whenever the tape counter or time remaining display is present in the viewfinder, it appears with a 3-dash read-out indicating the approximate status of Camera/Recorder battery power. When the battery is fully charged, the display reads "E---F". After few minutes, the display changes to "E--". When the last dash starts blinking, you should find an alternative power source or recharge the battery before continuing to use your Camera/Recorder.

### NOTES:

1. A new battery pack will provide the normal usable time after it is charged and discharged several times. If the battery pack is fully charged during the beginning of use, the usable time will be shorter than normal.
2. When the battery pack is charged and discharged several hundred times, the usable times becomes shorter. In this case, replace the battery pack with a new one.

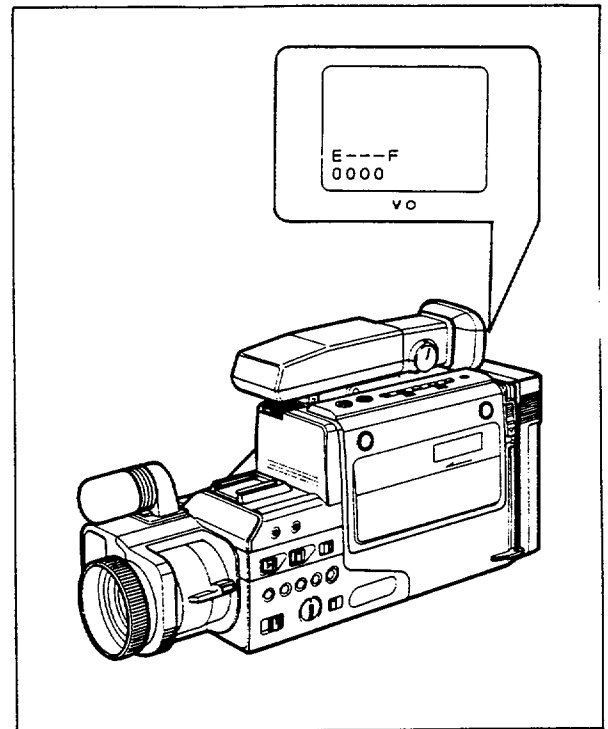

## CHARGING THE BATTERY PACK

1. Attach the Battery Pack and AC Adaptor to the Battery Charge Adaptor (Accessory No. 7).

**NOTE:** For attachment align the marks ► on the Battery Pack and AC Adaptor with them on the Battery Charge Adaptor so that they are joined together in the grooves, and slide them downward.

2. Plug the AC Adaptor power cord into AC outlet. The Charge Indicator Light will light while the Battery is accepting a charge, and will go out when the Battery is fully charged.

### NOTES:

1. The time for one Battery charging is approx. 70 minutes.
2. An optional 2-hour playback Battery may also be charged. The time for charging is approx. 140 minutes.
3. Battery Pack can also be charged by using the Car Battery Adaptor PV-YC800A.

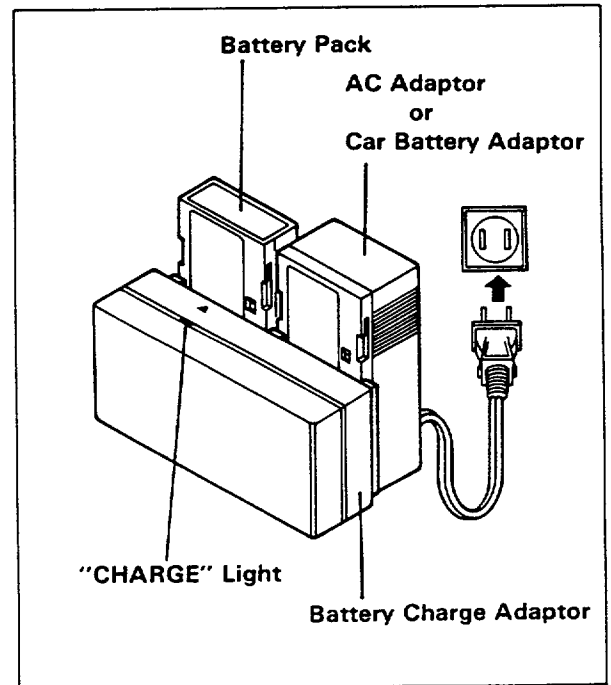

# IDENTIFICATION AND OPERATION OF CONTROLS

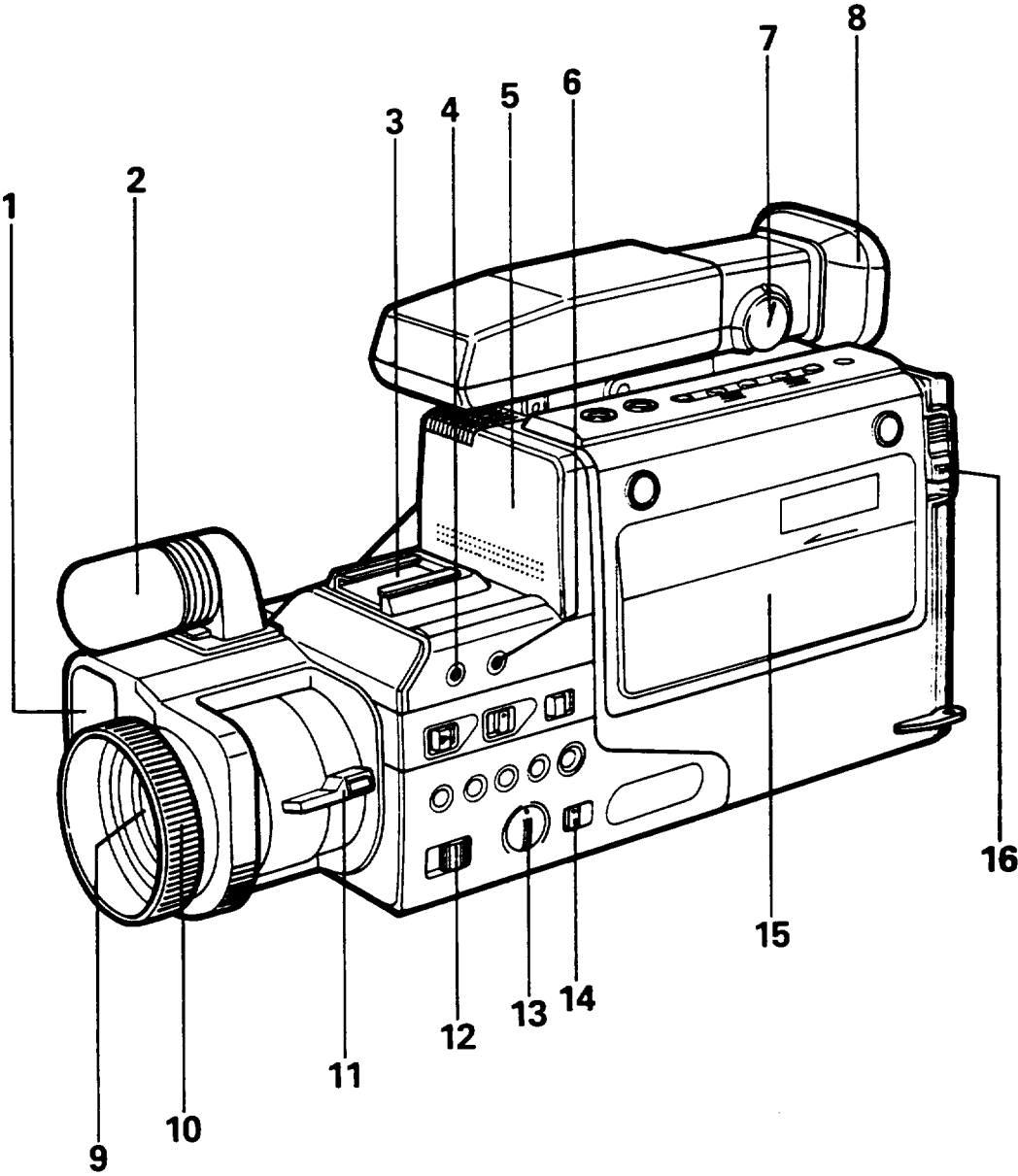



1. **Auto Focus Window**  
To automatically focus the camera lens, this window transmits and receives infrared light which is reflected off the subject. Make sure you don't obstruct this window when recording.
2. **Microphone**  
Sensitive to sounds coming from the direction in which the camera is pointed.
3. **Accessory Shoe**  
Used to attach light accessories (weighing less than 400g).  
You will need an optional Accessory Shoe Adapter (PV-YS850) to mount accessories such as an external microphone.
4. **External "MIC" rophone Jack**
5. **Time/Date Set Buttons (behind cover)**  
The Buttons behind the cover let you set the Camera/Recorder's internal calendar for the correct date.
6. **"EAR" phone Jack**  
Sound being recorded by the microphone or played back may be monitored by attaching earphone (Accessory No. 9) to this jack.
7. **Eyepiece Control**  
Use this control to adjust viewfinder focus. These adjustments will not affect the focus of the image recorded by the Camera/Recorder. This control permits most users who wear glasses to remove them while operating the Camera/Recorder.
8. **Electronic Viewfinder (EVF)**  
Displays what the Camera/Recorder lens sees. The electronic viewfinder also functions as a convenient black-and-white monitor during playback of recorded material.
9. **Lens**  
F1.4 (9 - 54 mm) 6:1 power zoom lens features auto focus and auto iris functions.
10. **Focus Ring**  
Do not attempt to manually turn the Focus Ring when the Camera/Recorder is in the AUTO FOCUS mode.
11. **Zoom Lever**  
The picture size can be magnified 6 times with the use of the zoom feature. Just rotate the Zoom Lever for a telephoto (T) or wide angle (W) picture. Macro close-up, as close as 1 cm from object, is feasible.
12. **"FOCUS AUTO/MANUAL" Switch**  
Set this Switch to the "AUTO" position for automatic focusing, and to the "MANUAL" position for focusing with the Focus Ring. When the Switch is pushed inwards while in the "MANUAL" position, automatic focusing is performed until the Switch is released.
13. **"IRIS" Control**  
With this control in the center click position, the Camera/Recorder automatically adjusts the lens opening for the best picture.  
The lens iris opening also can be adjusted manually to compensate for unusual lighting. When the subject is in bright light and the background is dark, turn this control counterclockwise to close the lens iris opening. When the background is in bright light and the subject appears too dark, turn the control clockwise to open the lens iris.
14. **"SHUTTER" Switch**  
Set the switch to "1/1200" when shooting a rapidly moving object. Generally, set to "NORMAL".
15. **Cassette Holder**  
Slide "EJECT" Button on the side panel to open the Cassette Holder. Be aware of the Cassette direction when inserting.
16. **Battery Release Lever**  
Releases the Battery, the AC Adaptor or Car Battery Adaptor attached to the Video Camera/Recorder.

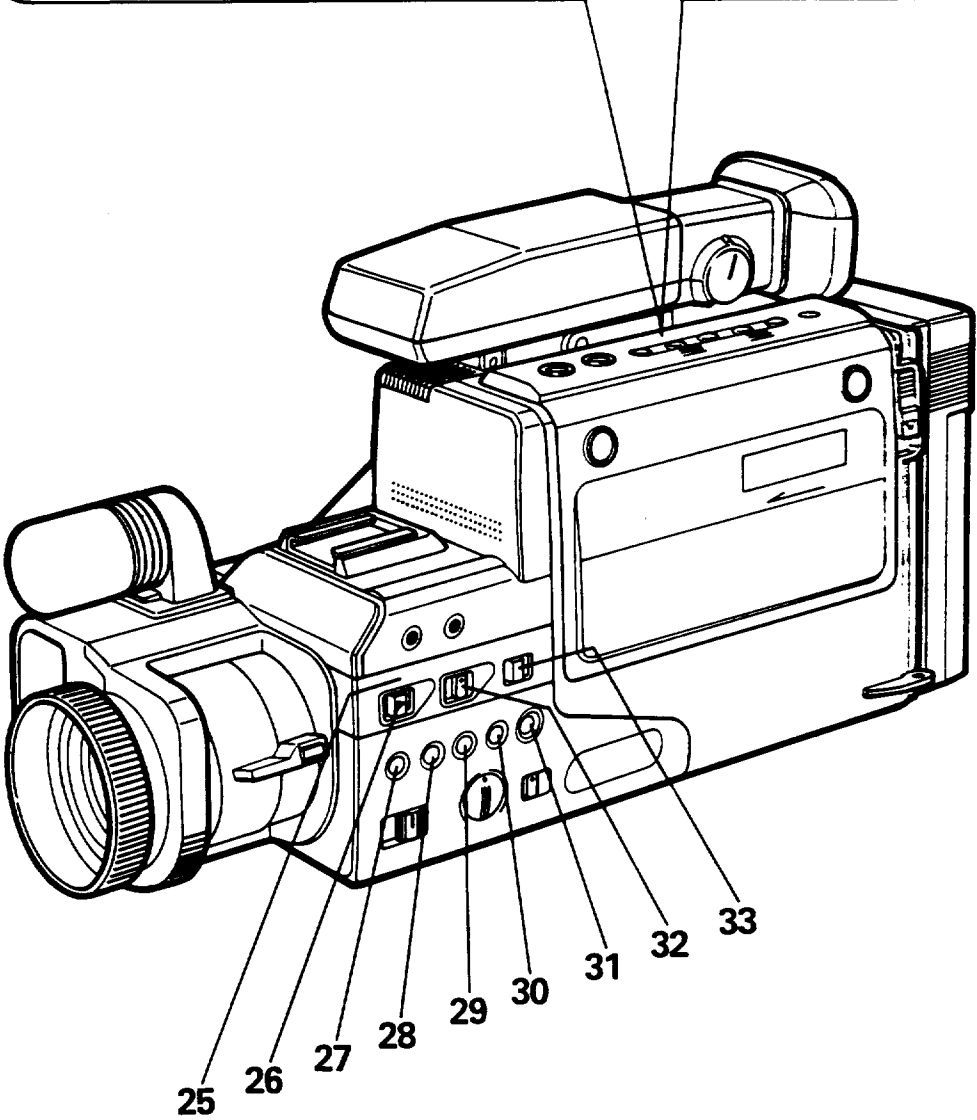
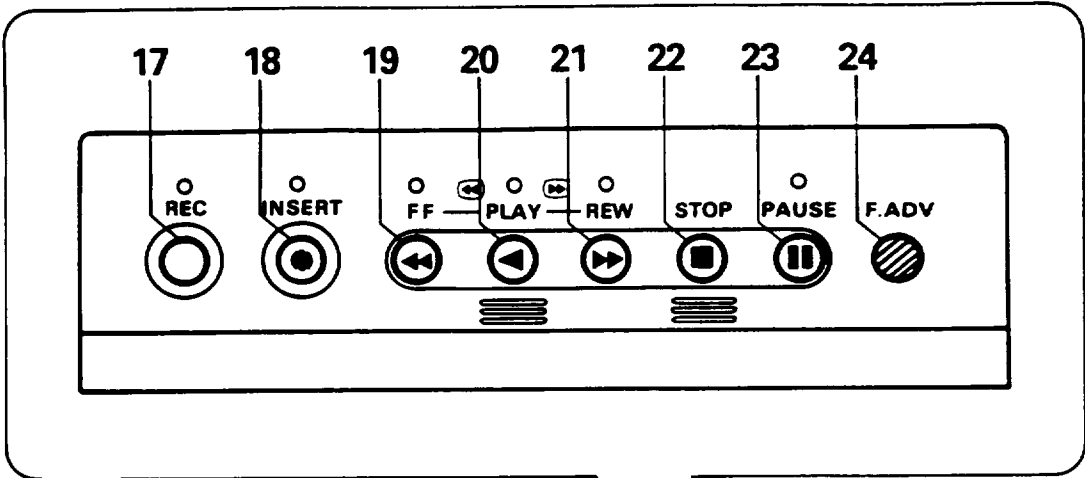

17. **"REC"ord Button**  
Used when recording from "A/V" jack on the top panel of the Camera/Recorder. This Button has no effect during camera recording operation.
18. **"INSERT" Button**  
This button is used when recording a scene or title on a previously recorded tape.
19. **"FF" Button**  
Press this Button during Stop or Rewind mode, and fast-forwarding starts.  
Press the Button during playback of tape, and the tape is played back in the forward direction approximately 5 times faster than the normal speed to confirm the recorded content.  
Press "PLAY" Button to return to normal playback mode or press "STOP" Button to stop tape movement.
20. **"PLAY" Button**  
Press to play back a tape.
21. **"REW"ind Button**  
Press this Button during Stop or Fast forward mode, and fast-rewinding starts. Press the Button during playback of tape, and the tape is played back in the rewind direction approximately 5 times faster than the normal speed to confirm the recorded contents.  
Press "PLAY" Button to return to normal playback mode or press "STOP" Button to stop tape movement.
22. **"STOP" Button**  
The "STOP" Button is effective when the "VTR/CAMERA" Switch is in the "VTR" position and used to stop playback, record, rewind and fast forwarding. This Button has no effect during camera recording operation.
23. **"PAUSE" Button**  
Press this Button to stop recording temporarily when recording from A/V jack. Press again to resume recording.  
This Button also allows you to view still frame during playback.
24. **"Frame Advance" Button**  
Press to view tape one frame at a time. Hold down button to advance frames continuously.  
Operates after "PAUSE" Button has been pressed during playback.
25. **"POWER"/Dew Indicator Light**  
Flashing of the Light indicates dew condensation on Camera/Recorder mechanism. While this Light is flashing, the unit will not operate. If this occurs, eject the tape and leave the power on. When the Light stops flashing, the unit can be operated.
26. **"POWER" ON/OFF Switch**  
Slide "POWER" ON/OFF Switch to turn Camera/Recorder on. Slide again to turn Camera/Recorder off.  
"POWER" Light illuminates when the Camera/Recorder is on.
27. **"DATE" Button**  
Operate this button to record the date superimposed on the picture being shot.
28. **"MODE" Button**  
Pressing this Button once causes a 4-digit tape counter and battery indicator display to appear in the Camera/Recorder's electronic viewfinder. Press again to display the battery indicator and the amount of time remaining on the cassette in the Camera/Recorder. Press a third time to delete all displays.
29. **"MEMORY" Button**  
This Button lets you index any place on a tape so that the Camera/Recorder will stop at that point during fast forward or rewind. When this Button is activated, the letter "M" will appear next to the counter display in the viewfinder. With the memory function active, the Camera/Recorder will stop rewind or fast forward operation when the tape counter reaches 0000.
30. **"RESET" Button**  
Pressing this Button resets the counter to 0000.
31. **"REVIEW" Button**  
Used to review the last few seconds of recorded segment in the record/pause mode.
32. **"VTR/CAMERA" Select Switch**  
Set "VTR/CAMERA" Select Switch to the "CAMERA" position to record from camera. The "VTR" position is used to play back a tape or to record from A/V jack on the top of Camera/Recorder.
33. **"EJECT" Button**  
Power must be turned on before operating this button.

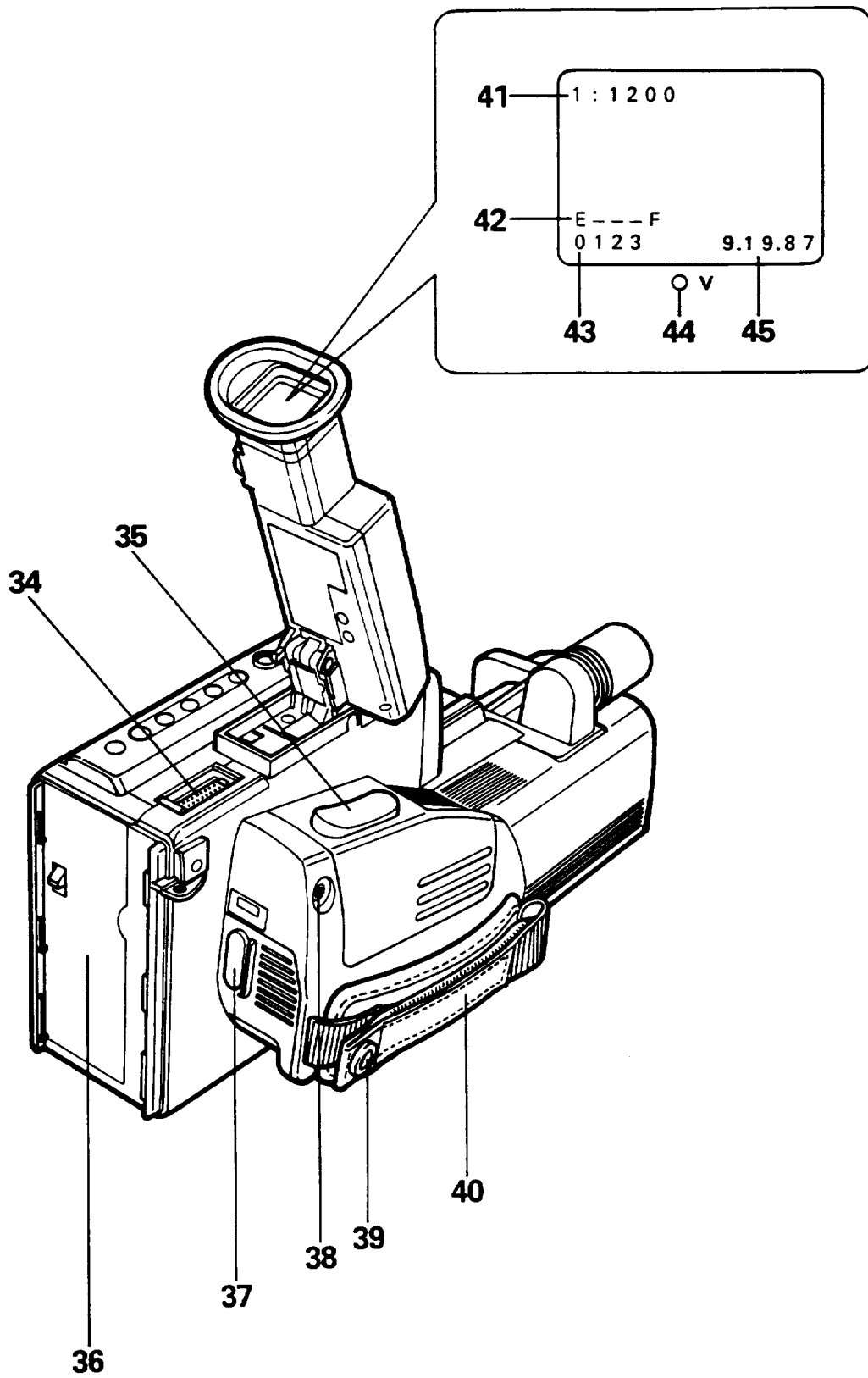

**34. "A/V" Jack**

Connecting the RF Converter Unit (Accessory No. 2) to this jack allows you to play back a recording through your TV receiver or to record a TV program from your TV.

**35. Power Zoom Switch**

This switch performs zooming electrically.  
"W": Picture becomes wider gradually.  
"T": Picture becomes telescopic gradually.

**36. Power Connector Panel**

Connect the power source. See pages 5 and 6 for details.

**37. Record Start/Stop Button**

This Button is used to control the Camera/Recorder. When this Button is pressed with the Camera/Recorder set to the camera recording mode, the tape runs to start recording. When this Button is pressed again, the tape stops and the Camera/Recorder enters the record/pause (stand-by) mode.

This Button has no effect when the "VTR/CAMERA" Select Switch on the side panel is in the VTR position.

**38. "CAMERA/REMOTE" Jack**

Recording and pausing may be remotely controlled by a wired Remote Pause Cable with switch (Optional accessory).

**39. Lens Cap Holding Tab**

Place the Lens Cap on this tab when you are ready to record a scene. The tab also prevents the Lens Cap from swinging around on its cord.

**40. Hand Strap**

Adjust to best fit to your hand.

**41. Shutter Speed Display**

This appears when the "SHUTTER" Switch is set to 1/1200, and goes out when the Switch is set to "NORMAL". (See page 18 for details)

**42. Battery Power Display**

This appears when the "MODE" Button is pressed. (See page 7 for details)

**43. Tape Counter/Tape Remaining Time Display**

Press the "MODE" Button to display the tape counter. Press it again to display the tape remaining time. (See pages 26 and 27 for details)

The reading of the tape counter is stored in memory by power supplied from the clock battery after the power of the unit is turned on. (The reading may not be stored in memory, however, when the power source is removed before turning the power switch off.)

**44. Record/Battery Indicator**

This is lit during recording and goes out when pause is instructed. When the power level of the battery pack becomes low, the indicator will flash.

**45. Date Display**

The year, month and day will appear when the "DATE" Button is pressed. They will disappear when the button is pressed again. (See page 20 for details)

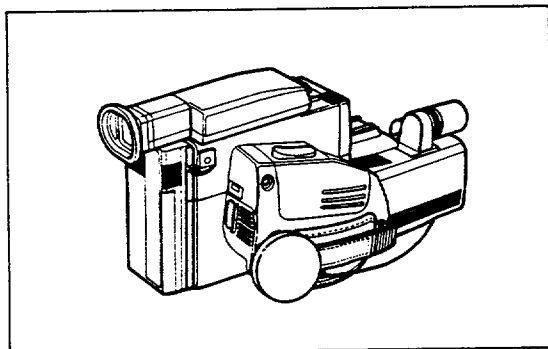

## RECORDING WITH CAMERA

1. Connect either one of the "POWER SOURCES". (See pages 5 and 6.)
2. Set "VTR/CAMERA" Select Switch to "CAMERA" position.
3. Slide "POWER" ON/OFF Switch to turn on power.

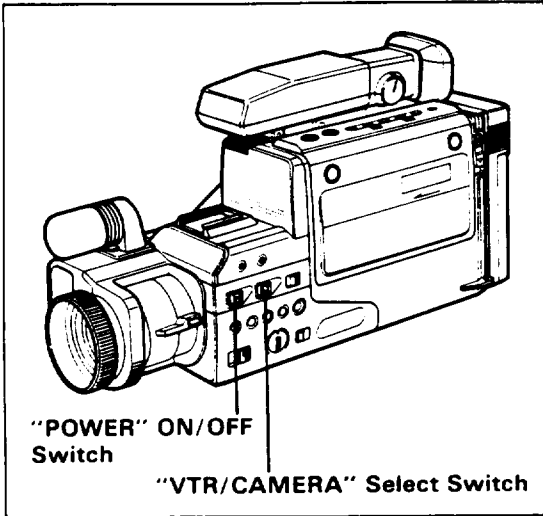

4. Slide "EJECT" Button and insert the cassette so the transparent window is toward you and the arrow toward the Cassette Holder. Slide the Cassette into Cassette Holder as far as it will go.

**NOTE:** If the power switch is not turned on, the Cassette Holder will not open.

5. Push and close the Cassette Holder. Camera/Recorder will enter record/pause mode automatically.

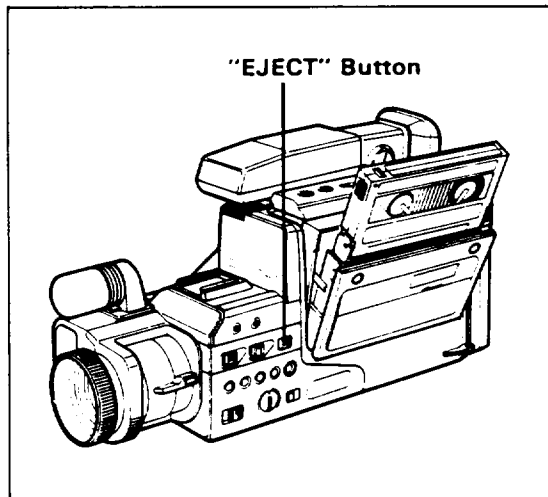

6. Set the "IRIS" Control to the center click (AUTO) position.
7. Set "FOCUS AUTO/MANUAL" Switch to "AUTO".
8. Set the "SHUTTER" Switch to "NORMAL".

**NOTE:** See page 4 for "EYEPIECE ADJUSTMENT".

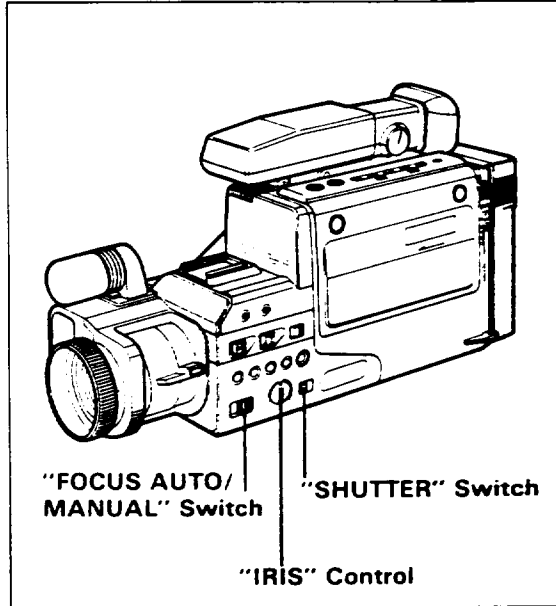

9. Now, press Record Start/Stop Button to start shooting the picture. You are now recording the picture you see through the Electronic Viewfinder. The Record/Battery Indicator in the Electronic Viewfinder will light.

**NOTE:** If the Camera/Recorder does not enter record mode, check the Tab on the bottom of cassette. See page 5 for detail.

10. Press Record Start/Stop Button to stop recording. Press the Button again to resume recording. The Record/Battery Indicator in the Electronic Viewfinder goes off in the record/pause (stand-by) mode.

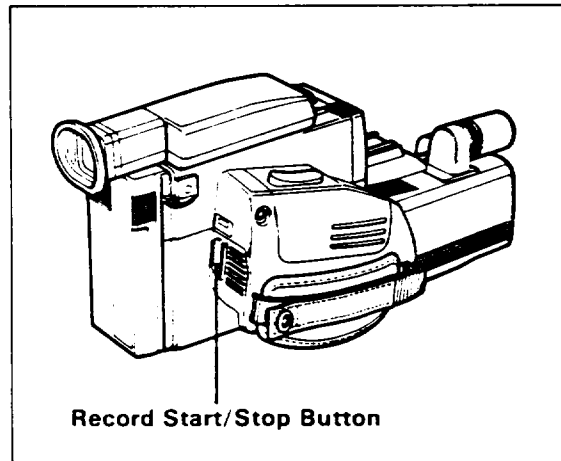

11. After recording, set "VTR/CAMERA" Select Switch to "VTR", and the Camera/Recorder will be now in the stop mode.

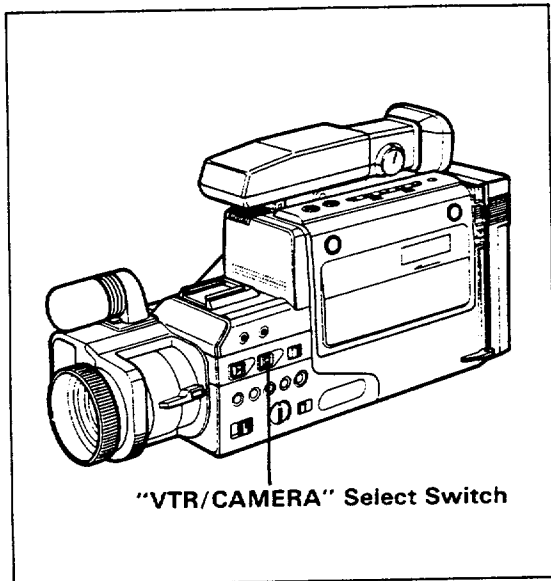

12. Press "REW"ind Button. The tape will be rewound to the beginning.
13. Press "PLAY" Button. The picture you just recorded will be seen through the Viewfinder and sound will be heard by earphone (Accessory No. 9).

**NOTE:** If you connect the Video Camera/Recorder to your TV, you can see the picture played back on your TV. Refer to "CONNECTIONS AND OPERATIONS FOR VIEWING THE PICTURE PLAYED BACK ON YOUR TV" on pages 22 and 23.

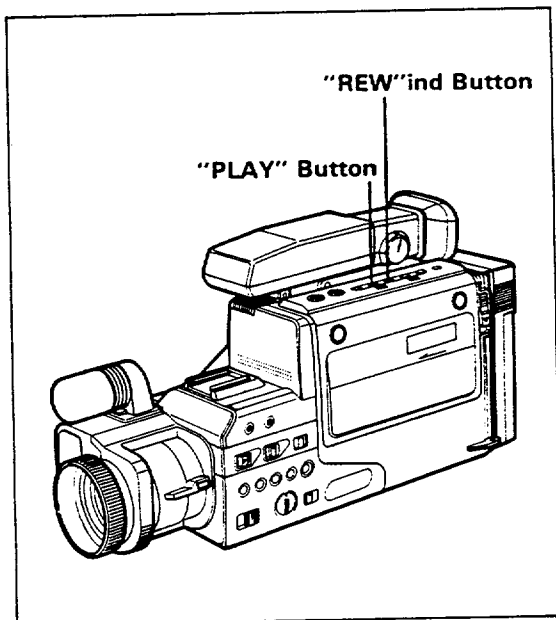

14. After playing, press "STOP" Button.

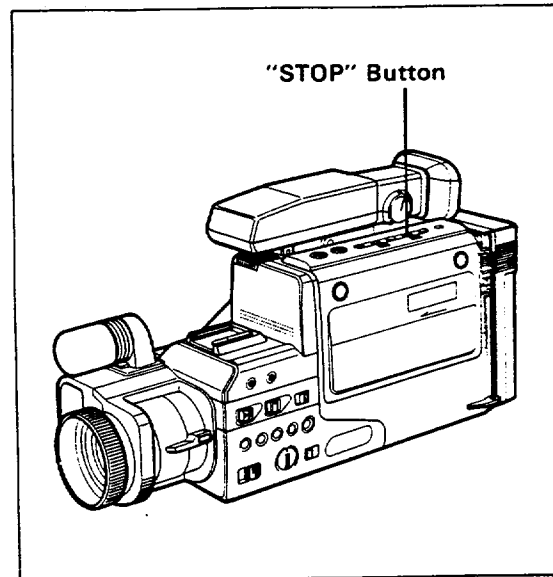

15. Slide "EJECT" Button to remove cassette and then set "POWER" ON/OFF Switch off.

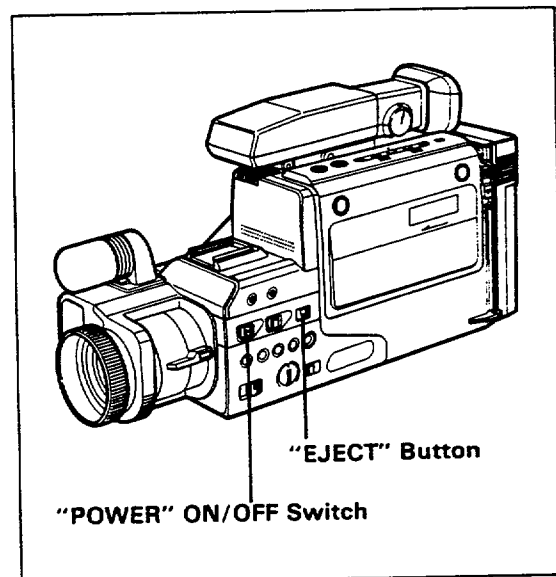

16. Always remove the power source from the Video Camera/Recorder after use.

# USING THE AUTO FOCUS FEATURE

With the "FOCUS AUTO/MANUAL" Switch set to "AUTO" position, the ordinary subjects are automatically in optimum focus.

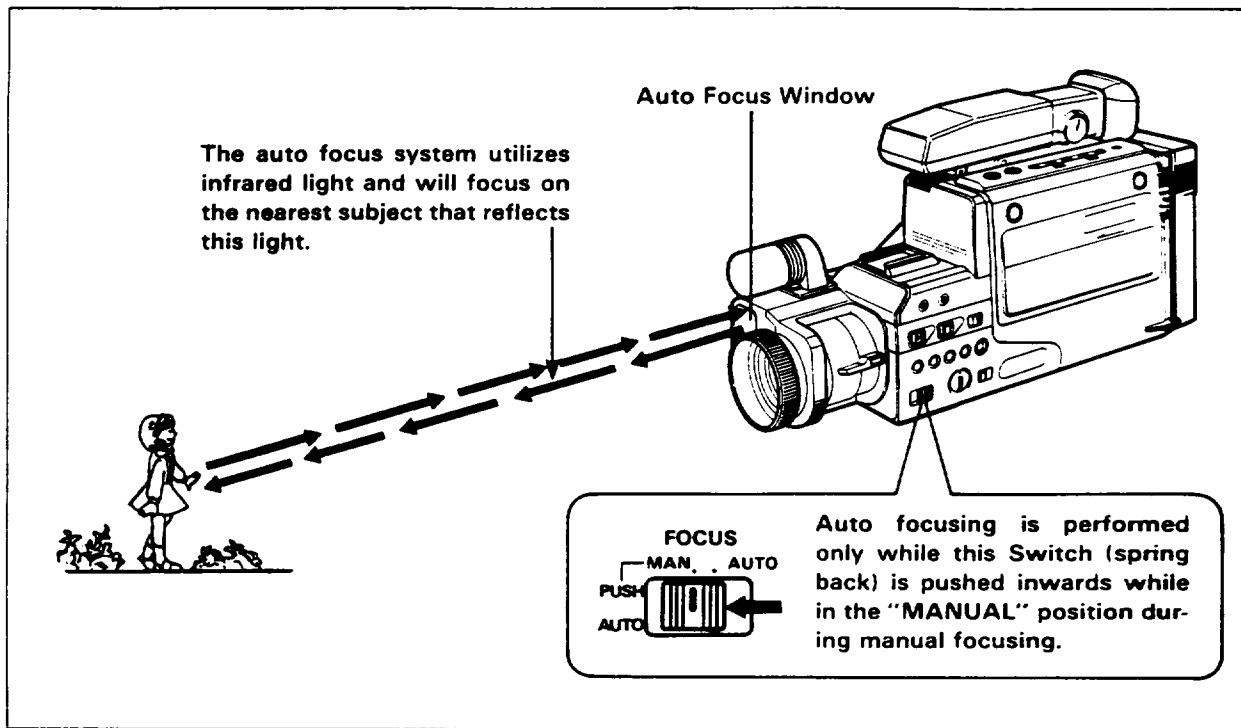

## ■ DIFFICULT AUTO FOCUS

The distance between the Auto Focus Window and the subject is measured by infrared light, and the Focus Ring is automatically turned for focusing. However, with scenes like those shown below, the auto focusing may not operate properly. In these cases, use the manual focus. See next page.

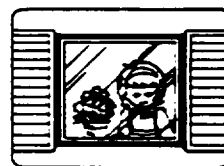
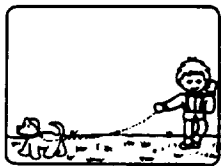

1. Subject is not in the center.
2. Subject in far and near positions at the same time.
3. Subject with continuous variation from far to near positions.
4. Subject behind glass.

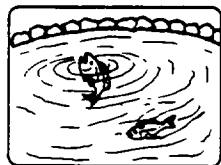

5. Black subject or water which reflects infrared light poorly.
6. Subject always moving such as a crowd.
7. Subject in snow or fog.

### 8. Miscellaneous

- Sections with rapidly changed contrast
- Subject with equal-pitch pattern
- During macro shooting
- Subject more than 10 m away
- When a generally available conversion lens, etc. is used



## ■ MANUAL FOCUSING

1. Set "FOCUS AUTO/MANUAL" Switch to "MANUAL" position.
2. Zoom up the subject by turning the Zoom Lever.

**NOTE:** See page 19 for "USING THE POWER ZOOM FEATURE".

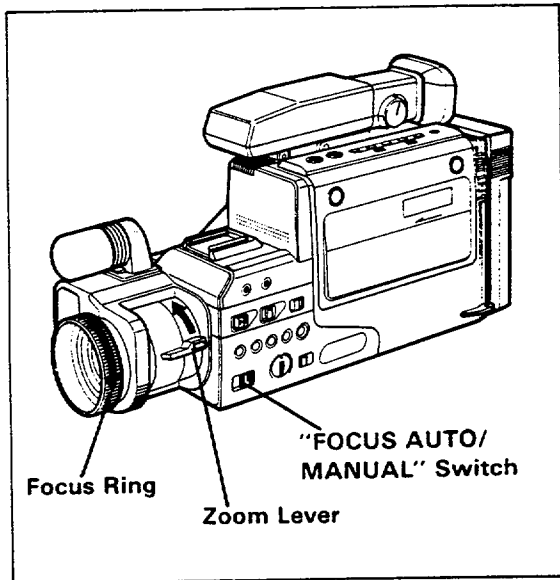

3. Focus on the subject by turning the Focus Ring.

**NOTE:** If focusing is performed without zooming up first, the picture may become out of focus when the zoom-up is done during actual picture taking.

4. Then, zoom back the subject as desired.

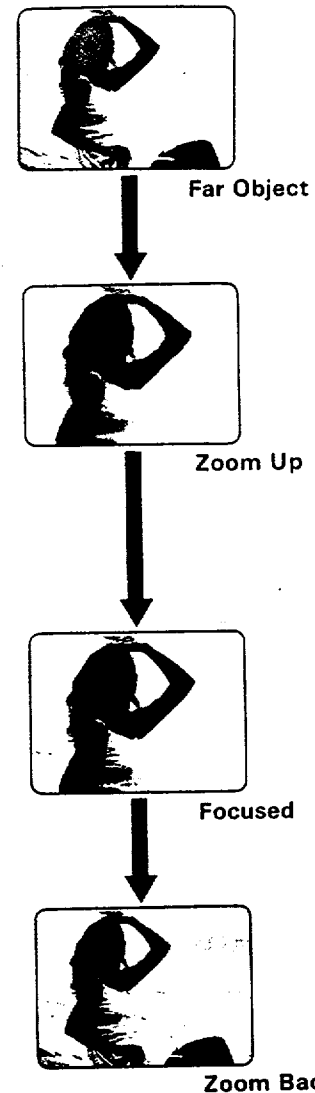

## USING THE AUTO IRIS FEATURE

This Camera/Recorder is provided with an auto iris mechanism which automatically adjusts the lens aperture in accordance with the incident light when the "IRIS" Control is placed in the center (AUTO) position. When the subject is dark, the iris opens automatically, and it closes when the subject is bright. When the power is switched off, the iris is automatically set to the fully closed position.

### ■ To manually adjust the iris

- When the subject is bright and the background is dark, turn "IRIS" Control to the "CLOSE" position to reduce the iris opening.
- When the background is bright and the subject appears to be too dark, turn "IRIS" Control to the "OPEN" position to increase the iris opening.

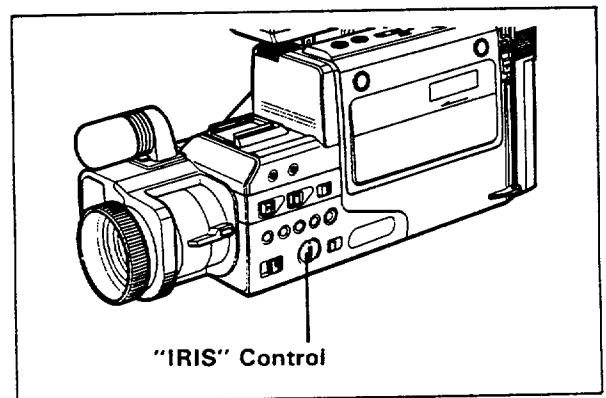

## USING THE FADE-IN/FADE-OUT FEATURE

Fade-in and fade-out are shooting techniques to soften the transition from one scene to another. Fade-in starts with a dark picture and gradually increases in brightness. In fade-out, the opposite takes place; a normal picture gradually becomes darker until it disappears completely.

### ■ FADE-IN

1. Turn the "IRIS" Control fully counterclockwise before starting recording. The picture in the Electronic Viewfinder disappears.
2. Gradually turn the "IRIS" Control to the center (AUTO) position after starting recording.

### ■ FADE-OUT

1. Set the "IRIS" Control to the center (AUTO) position before starting recording.
2. Gradually turn the "IRIS" Control fully counterclockwise after starting recording. The picture fades out.

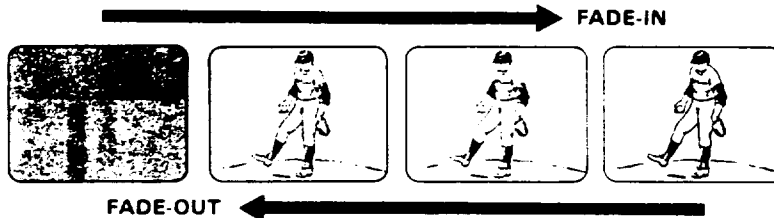

## USING THE HIGH SPEED SHUTTER FEATURE

Use this to shoot tennis and golf shots that contain rapid movement. You can replay still or slow motion pictures at the crucial moments without any disturbance.

Set the "SHUTTER" Switch to "1/1200". "1:1200" appears in the viewfinder. (Setting the switch to "NORMAL" sets the shutter speed to "1/60" second and nothing is displayed in the viewfinder.)

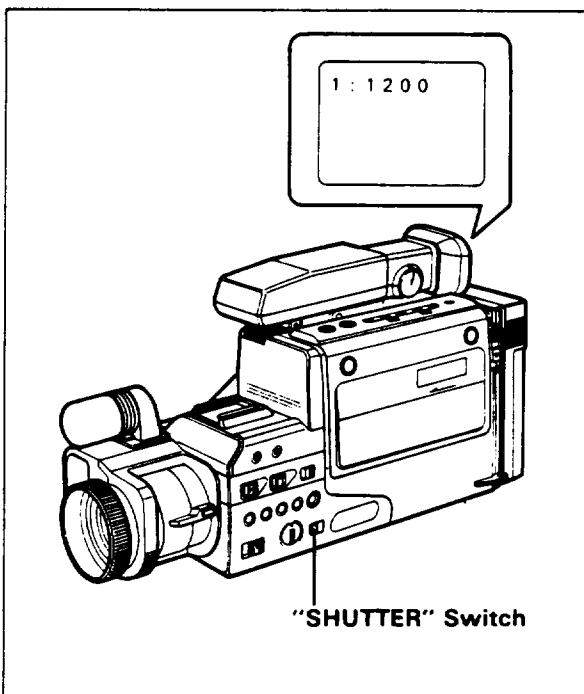

### NOTES:

- Tape recorded at "NORMAL" (1/60-second speed) will provide 60 frames of 1/60-second movement in a second, and tape recorded at "1/1200" will provide 60 frames of 1/1200-second movement in a second. If a tape recorded at "1/1200" is played back normally, movements will not be smooth.
- Return the "SHUTTER" Switch to "NORMAL" after recording is completed.
- When shooting at 1/1200 speed, more light is required because the pictures become darker than in shooting at NORMAL (1/60) speed.
- When the camera is pointed at an object that is moving rapidly, it may not be focused correctly in the auto focus mode. In this case, focus manually.
- When recording with illumination such as a fluorescent lamp, a mercury vapor lamp or a sodium lamp, the picture may become bright or dark (flickering).
- Because instantaneous movements are shot for 1/1200 seconds each, the picture becomes darker than normal.
- The "IRIS" Control may not work.
- The brightness of the picture changes momentarily when the "SHUTTER" Switch is changed over, but this is not a malfunction.

## USING THE POWER ZOOM FEATURE

- Press Power Zoom Switch on the "W" side, and the picture gradually widens.



- Press Power Zoom Switch on the "T" side, and the picture gradually becomes telescopic.

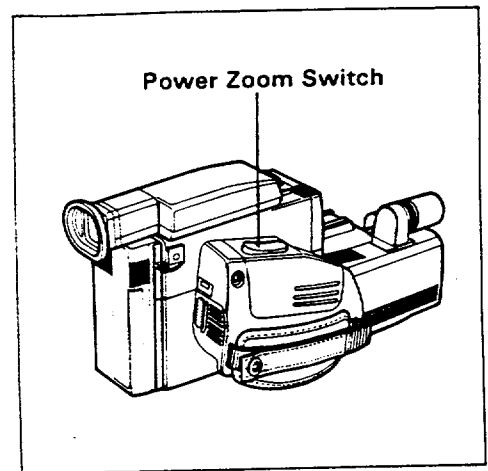

**NOTE:** Do not touch the Zoom Lever or Zoom Ring during power zooming.

## USING THE MACRO FEATURE

It permits you to shoot subjects as close as 1 cm from the lens tip.

1. Set "FOCUS AUTO/MANUAL" Switch to "MANUAL" position.
2. Turn the Zoom Lever to "MACRO" while pressing "MACRO" Switch.
3. Turn the Zoom Ring within the "MACRO" range (green line on the Zoom Ring) for focusing.

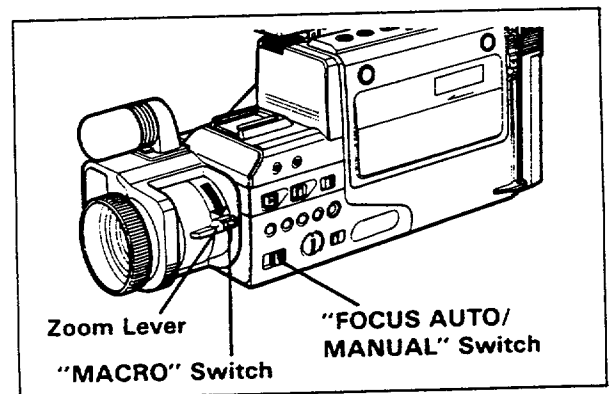

## USING THE INSTANT REVIEW FEATURE

1. In record/pause (stand-by) mode, press "REVIEW" Button, and the recorded scene of the last few seconds is played back in the reverse direction and then played back in the forward direction.
2. When the tape reaches the end of the scene you have just recorded, the Video Camera/Recorder returns to the record/pause (stand-by) mode. Recording starts again when the Record Start/Stop Button is pressed again.

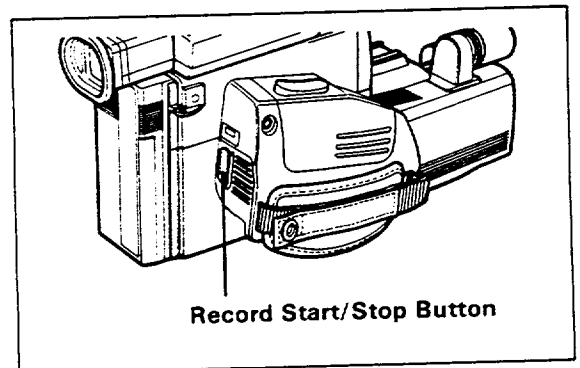
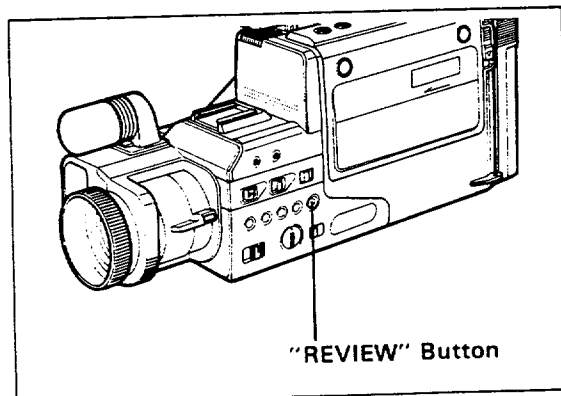

## USING THE DATE RECORDING FEATURE

The date can be recorded on your tapes to act as a handy reference when viewing them at a later time. Use the following procedure to set the current date and time.

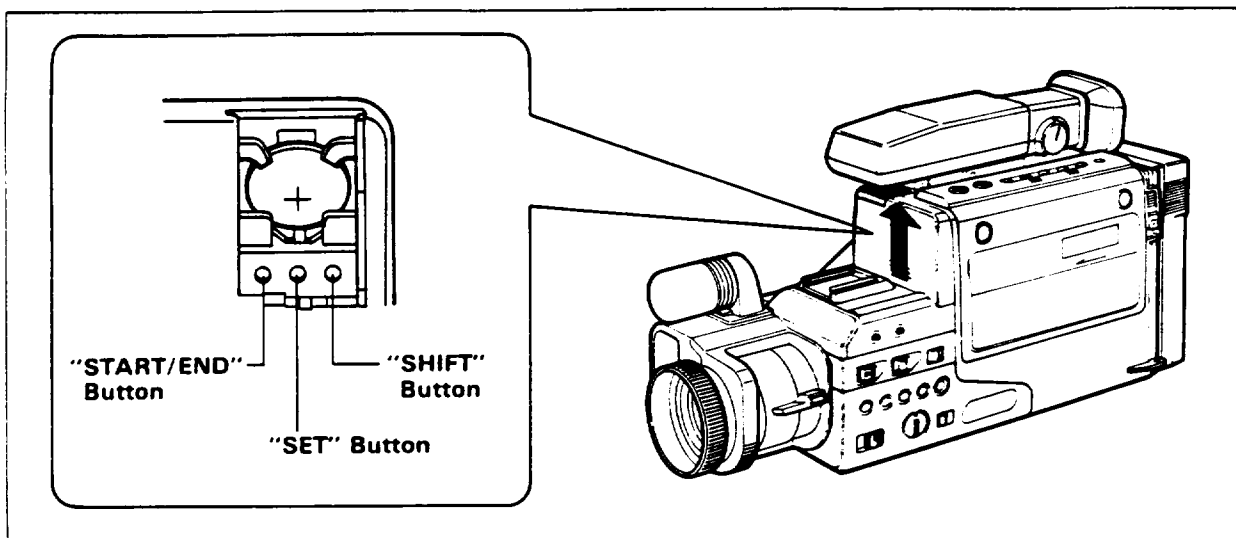

1. Load the Camera/Recorder's date/clock battery (Accessory No. 8) as described on page 4.
2. Turn on Power of Camera/Recorder. The clock and date graphics appear in the Viewfinder and the first "1" flashes.

(For example)

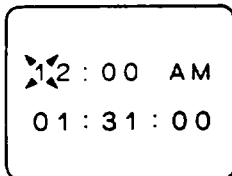

3. Press "SET" Button to select correct hour. When the correct hour appears, press "SHIFT" Button.

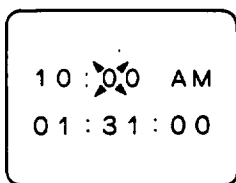

4. Repeat Step 3 to select minute, AM/PM, month, day and year.

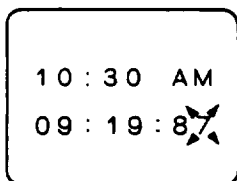

5. Press "START/END" Button to activate the date/clock. The clock graphics disappear and the date graphics remain.
6. Press "DATE" Button on the side of Camera Recorder to remove the date display from the viewfinder. The date/clock will continue to keep the correct time in memory.

### NOTES:

1. To correct date/clock information during programming, press "START/END" Button twice and press "SHIFT" Button until the incorrect digit is flashing. Then use "SET" Button to enter the correct digit. If you wish to correct information after starting the date/clock, first press the "DATE" Button to display the date graphics, then press "START/END" Button and repeat Steps 3 through 6.
2. The date graphics will be recorded whenever they appear in the viewfinder. To display date, press "DATE" Button. Pressing "DATE" Button again removes graphics.

# PRODUCING BEST COLOR PROGRAM

## LIGHTING – Lighting should be uniform from the top –

### Essential points on lighting people

1. A key light should be provided at the upper left in front of the person.
2. A weaker base light (spot) should be provided at the upper right and balanced with the key light.  
(Adjusting so that the left:right ratio is 2 : 1.5 by moving the lights backwards and forwards.)
3. Use one more light behind the subject. This emphasizes the person's head and shoulders and prevents the subject from being lost in the background.

**Caution:** Do not place lighting equipment near the Video Camera/Recorder as heat from the lighting equipment can cause the Video Camera/Recorder to malfunction.

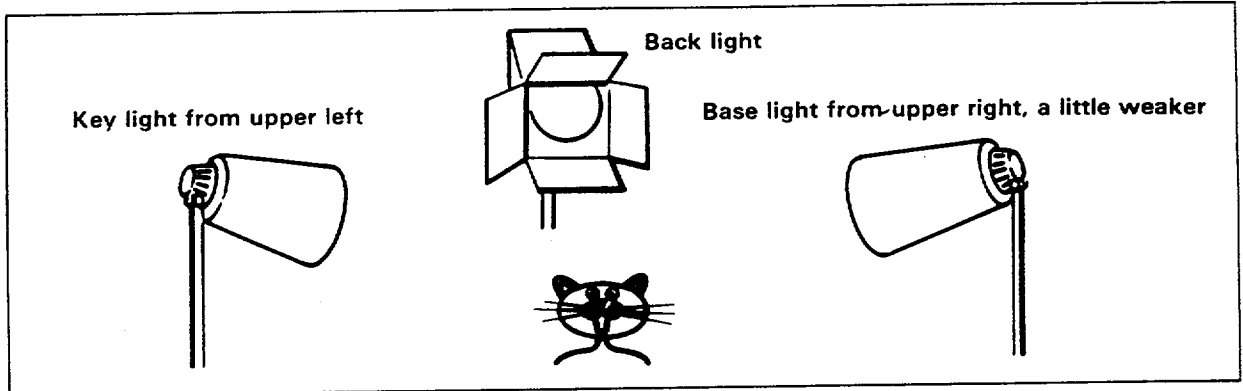

### Approximate brightness value (for reference only)

Illumination of 500 to 100,000 lux is required for clearest pictures, though the camera can shoot an object in illumination of 7 to 100,000 lux. Increase illumination when object illumination is less than 500 lux. Install an ND (Neutral Density) filter (46 mm dia. and 0.75 mm pitch) on the lens if an object's illumination exceeds 100,000 lux.

Unit: lux

7	<ul style="list-style-type: none"> <li>• Candle at 20 cm (10–15)</li> <li>• Cigarette lighter at 30 cm (15)</li> </ul>
100	<ul style="list-style-type: none"> <li>• During intermission at a movie theater (15–35)</li> <li>• Workshop in a machinery factory (150–200)</li> <li>• Arcade at night (150–200)</li> <li>• Flashlight at 1 meter (250)</li> <li>• Study desk with fluorescent lighting (400)</li> <li>• Office with fluorescent lighting (400–500)</li> <li>• Library reading room (400–500)</li> <li>• Bowling alley (500)</li> </ul>
1,000	<ul style="list-style-type: none"> <li>• Sales floor of a department store (500–700)</li> <li>• Clear day one hour before sunset (1,000)</li> <li>• Cloudy day one hour after sunrise (2,000)</li> </ul>
10,000	<ul style="list-style-type: none"> <li>• Cloudy day at 10 AM (25,000)</li> <li>• Cloudy day at noon (32,000)</li> <li>• Clear day at 3 PM (35,000)</li> <li>• Clear day at 10 AM (65,000)</li> </ul>
100,000	<ul style="list-style-type: none"> <li>• Clear day at noon (100,000)</li> </ul>

Do not mount a camera light on this unit. Heat generated by the camera light may damage the case.

## CONNECTIONS AND OPERATIONS FOR VIEWING THE PICTURE PLAYED BACK ON YOUR TV

To play back a tape recorded on your Video Camera/Recorder and view it on your TV receiver, you must connect the Video Camera/Recorder to the TV receiver using RF Converter Unit (Accessory No. 2) or Audio Video Output Cable (Optional).

**Example 1: If your TV is a regular TV, use RF Converter Unit (Accessory No. 2)**

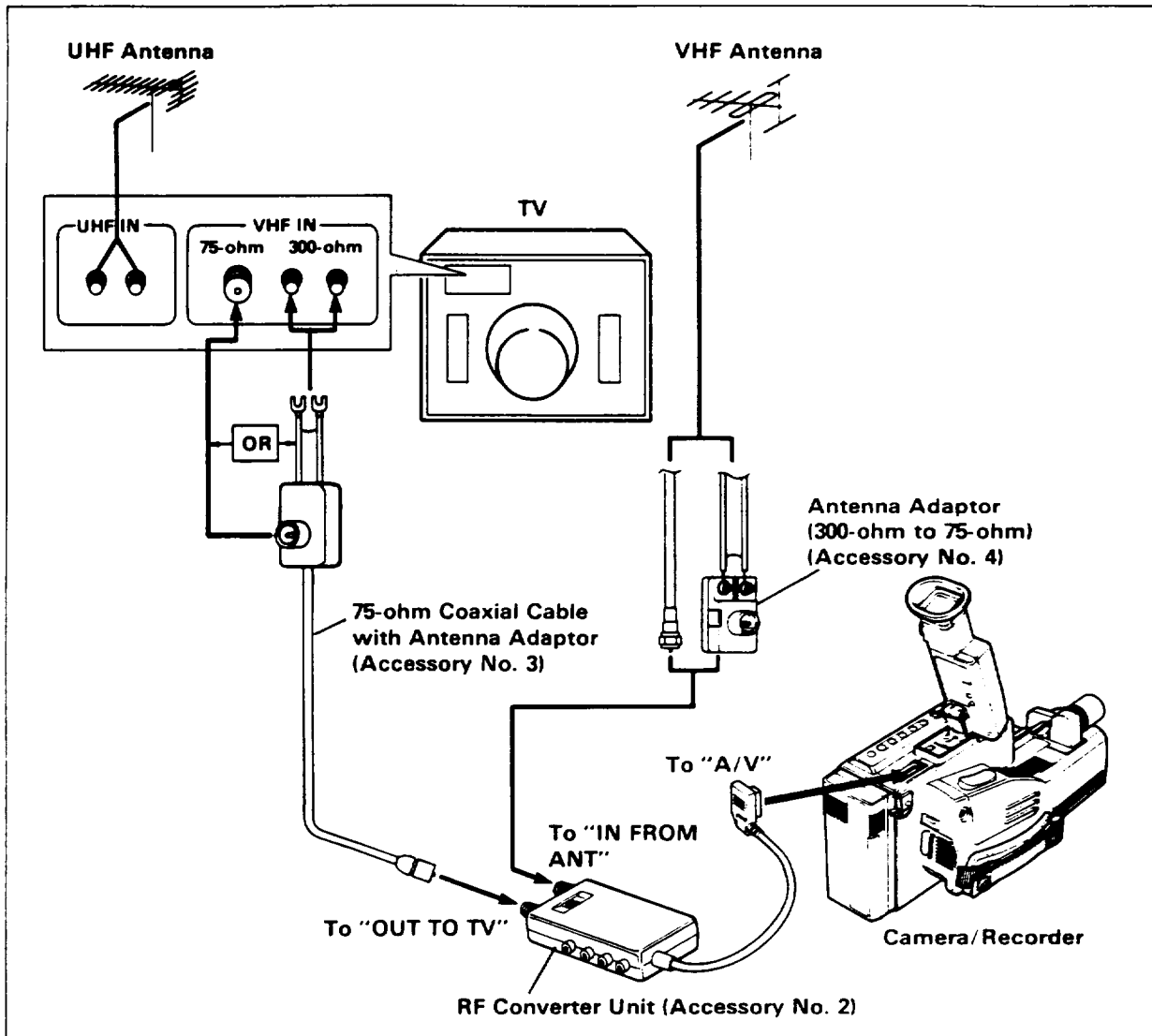

1. Disconnect the VHF antenna leads from the rear of the TV receiver.

**NOTE:** Leave the UHF antenna leads connected to the TV.

2. Connect the VHF antenna lead to "IN FROM ANT" on the RF Converter Unit. If the cable is round (75-ohm), it will connect directly to the "IN FROM ANT". If it is the flat type (300-ohm), connect it to the Antenna Adaptor (300-ohm to 75-ohm) and slip the Adaptor on to the "VHF IN FROM ANT" terminal.

3. Connect the 75-ohm Coaxial Cable to "OUT TO TV" on the RF Converter Unit.
4. Connect the other end to the VHF antenna terminal on the TV, as illustrated above.
5. Connect the Connector Cable from RF Converter Unit to "A/V" jack on the Video Camera/Recorder.
6. Turn on the TV and set to Channel 3 unless Channel 3 is one of the TV stations in your area. If Channel 3 is used in your area, set your TV to Channel 4.

- Set the RF Channel Select Switch on the RF Converter Unit to "CH3" or "CH4" to match the channel selector on your TV. This is the Video Camera/Recorder channel on your TV set. Your TV receiver must be tuned to this channel any time a video cassette is played back on the Video Camera/Recorder.

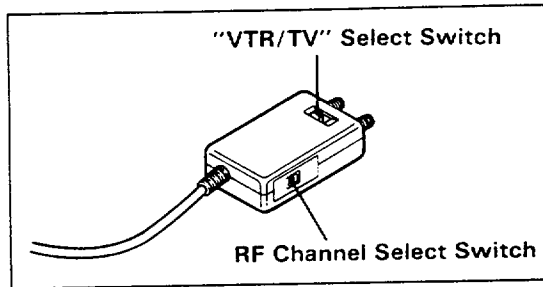

- Set "VTR/TV" Select Switch on the RF Converter Unit to "VTR".
- Set "POWER" ON/OFF Switch on.
- Slide "EJECT" Button on the Video Camera/Recorder and then insert the cassette.

- Set "VTR/CAMERA" Select Switch to "VTR" position.
- Press "PLAY" Button.
- After playing press "STOP" Button.

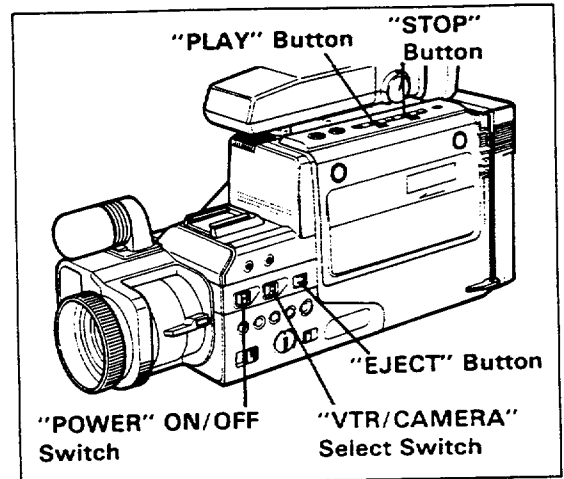

**NOTE:** If you want to watch a TV program with Video Camera/Recorder connected as illustrated, set "VTR/TV" Select Switch on the RF Converter Unit to "TV" position.

**Example 2:** If your TV has "VIDEO IN" and "AUDIO IN" jacks, you may use either RF Converter Unit (Accessory No. 2) or Audio/Video Output Cable (Optional).

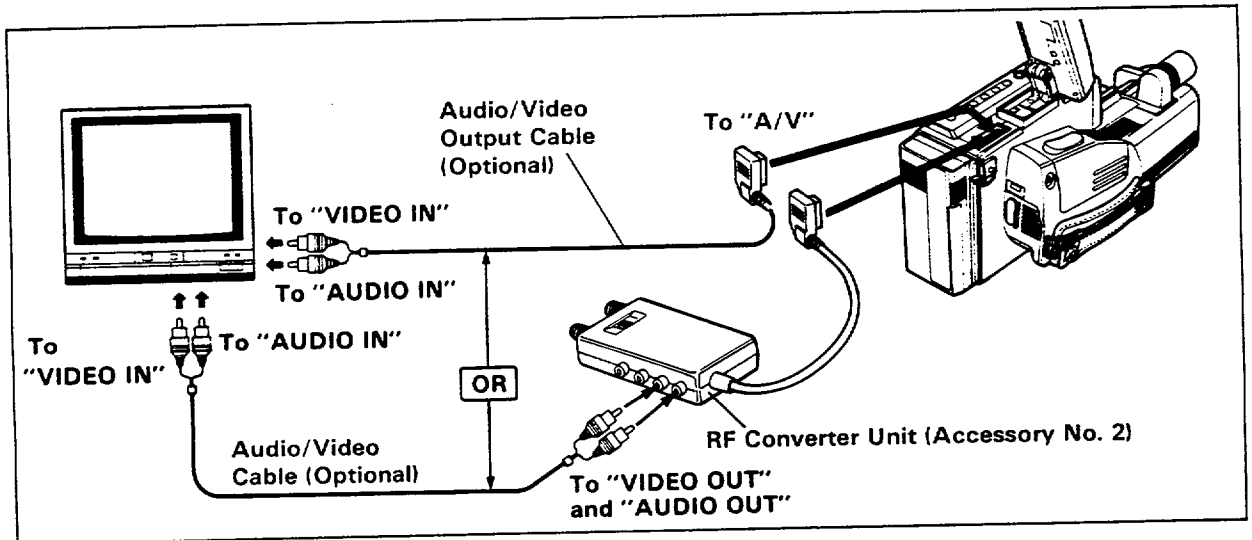

#### Using RF Converter unit

- Connect "VIDEO OUT" and "AUDIO OUT" of RF Converter Unit to "VIDEO IN" and "AUDIO IN" of TV using the optional cables.
- Connect the Connector Cable from RF Converter Unit to "A/V" jack on the Video Camera/Recorder.
- Perform same procedures in Steps 9 through 13 of "Example 1" above.

#### Using Audio/Video Output Cable

- Connect the Audio/Video Output Cable (Optional) to "AUDIO IN" and "VIDEO IN" of your TV.
- Connect the other end of the Audio/Video Output Cable to "A/V" of your Video Camera/Recorder.
- Perform same procedures in Steps 9 through 13 of "Example 1" above.

# CONNECTIONS AND OPERATIONS FOR RECORDING TV PROGRAM

If your TV has video/audio out jacks, you can record the TV program with Camera/Recorder.

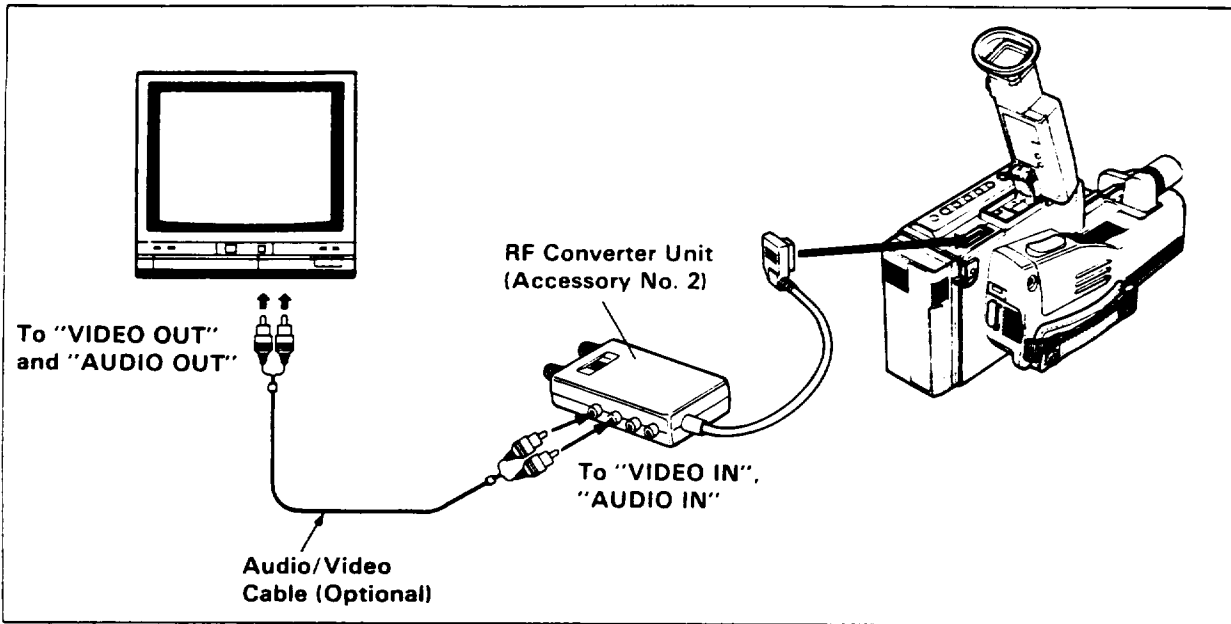

1. Connect the Connector Cable from RF Converter Unit to "A/V" jack on the Video Camera/Recorder.
2. Connect the Audio/Video Cable (Optional) to "AUDIO IN" and "VIDEO IN" of the RF Converter Unit. Connect the other ends to "AUDIO OUT" and "VIDEO OUT" of your TV respectively.
3. Set "VTR/CAMERA" Select Switch to "VTR".
4. Slide "POWER" ON/OFF Switch to turn on power.
5. Slide "EJECT" Button and insert the cassette.
6. Press "RECORD" Button to start recording. You are now recording the program you see on your TV screen. To stop recording temporarily press "PAUSE". Press again to resume recording.
7. Press "STOP" Button to stop recording.

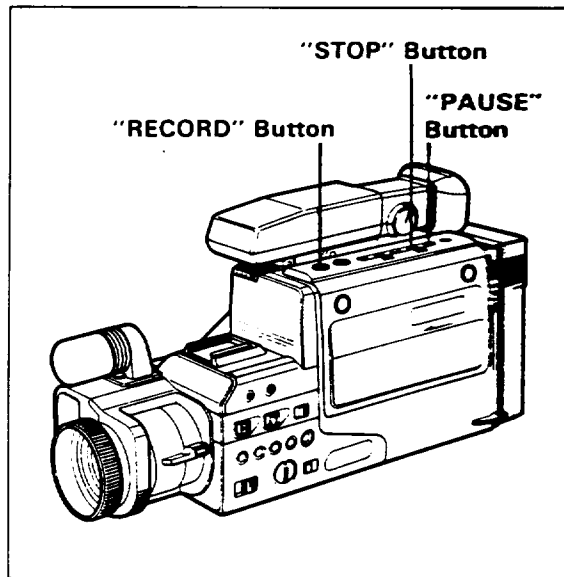
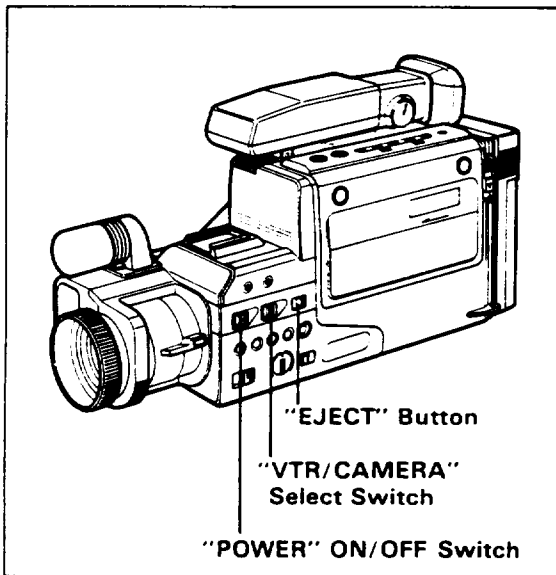



8. Slide "EJECT" Button to remove the cassette then set "POWER" ON/OFF Switch off.

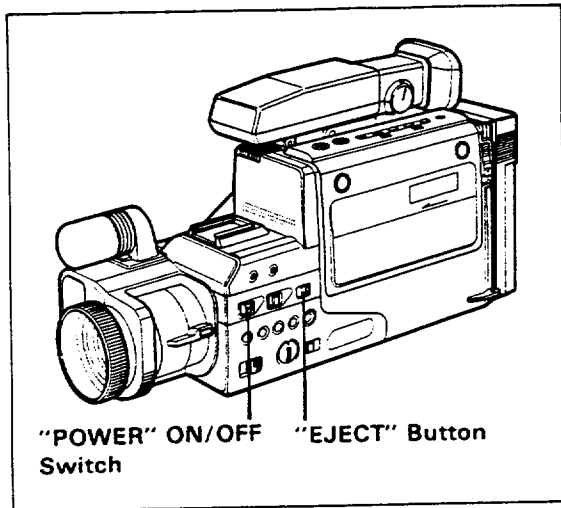

9. Remove the Power Source from the Video Camera/Recorder.

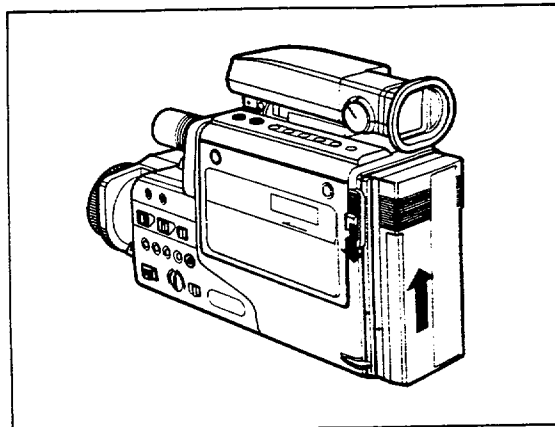

**NOTE:** Be sure to remove the Power Source after using the camera.

## USING THE PAUSE AND FRAME ADVANCE FEATURE

When "PAUSE" Button is pressed during playback, "PAUSE" Light will come on and a still picture can be seen. To start again press "PAUSE" Button and "PAUSE" Light will go off and playback will be resumed.

A frame-by-frame picture can be viewed by pressing the Frame Advance button during the still playback mode. Frames are advanced continuously if you keep the button depressed.

### NOTES:

- There will be some noise (interference) in the still picture.
- Three frames may be advanced when you press the Frame Advance button once so that a picture without noise and jitter can be obtained.
- If you see vertical shaking on the TV screen in the still playback mode, turn the vertical jitter control on the bottom of the Camera/Recorder to minimize shaking. (Turning this control can also suppress shaking during slow playback.)

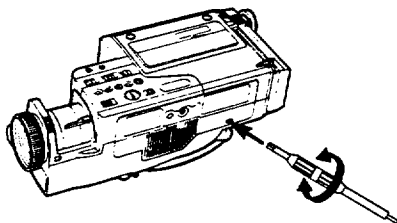

Adjustment Driver (provided)

- When the still playback mode continues for about 5 minutes, the Camera/Recorder switches to the stop mode automatically to protect the tape from damage.

Pressing "PAUSE" during recording from "A/V" jack of Camera/Recorder (for example, during recording TV program) stops recording temporarily. Pressing the Button again re-starts recording.

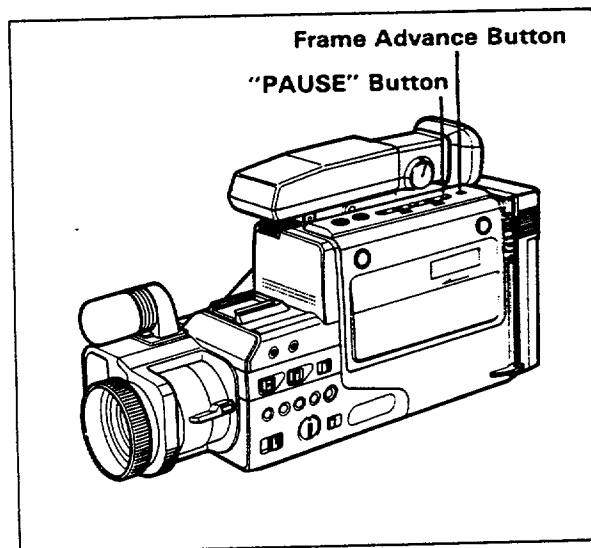

## USING THE SLOW FEATURE

When the "PLAY" Button is pressed during still playback, the tape will be played back at slow speed. To release Slow Playback, press the "PLAY", "PAUSE" or "STOP" Button. The Camera/Recorder will change to the mode corresponding to the button pressed.

### NOTES:

- There will be some noise (interference) in the slow playback picture.
- When the slow playback mode continues for about 5 minutes, the Camera/Recorder switches to the normal playback mode automatically to protect the tape from damage.

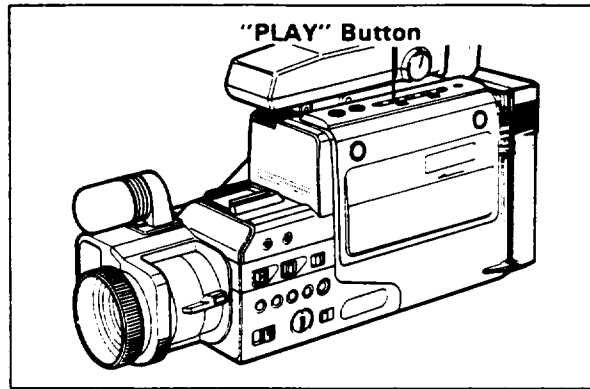

## USING THE F-SEARCH AND R-SEARCH FEATURES

When you press "FF" or "REW"ind Button during playback, the tape will be played back at a speed about 5 times faster than the normal playback speed, and you can easily locate a certain spot on the tape.

**NOTE:** There will be some noise (interference) in the F-search or R-search pictures.

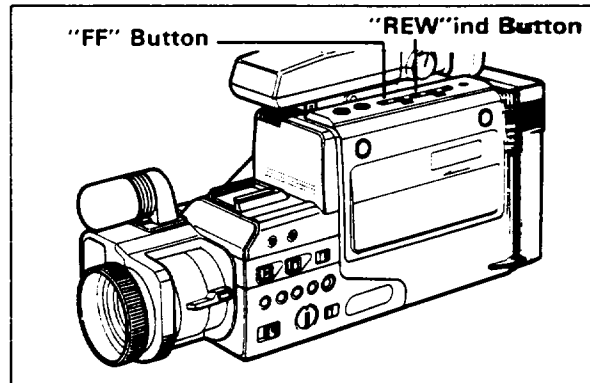

## USING THE MEMORY FEATURE

Pressing "MODE" Button causes a 4-digit counter display to appear in the viewfinder (along with the battery level graphic). The tape counter acts as a handy reference to help you locate taped segments. Press "RESET" Button to set the counter to "0000" before starting to record or play. Note the number on the tape counter at the beginning and end of each program you want to record. This will allow you to use the counter to locate desired programs.

The tape counter also includes a switchable "memory" feature. When the memory is on, the tape automatically stops when the counter reads "0000" during Fast Forward and Rewind. This is useful if there is a section of tape you want to review immediately after recording, or if you want to return to the same point several times in a row.

To use the counter memory, reset the counter to "0000" when you reach the point on a tape you wish to index. Then press the "MEMORY" Button. The letter "M" will appear with the counter display. Continue to play or record the tape, and when you wish to return to the index point, simply press "REW"ind from the stop mode.

- If the "REW" or "FF" Button is pressed near "0000", the tape may not stop at a reading of "0000".

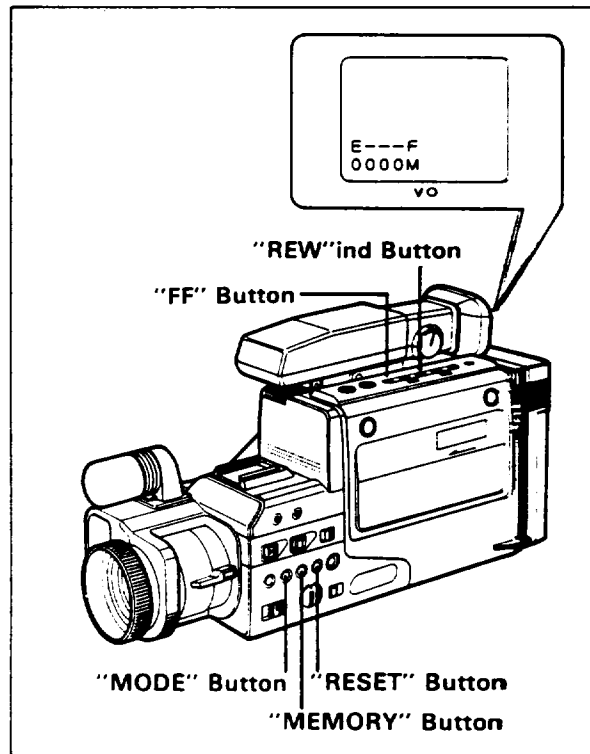

## USING THE TIME REMAINING FEATURE

When the tape counter is present in the viewfinder, pressing "MODE" Button will change the display to a read-out showing the amount of recording time left on the tape. Pressing "MODE" Button again clears all graphics from the viewfinder.

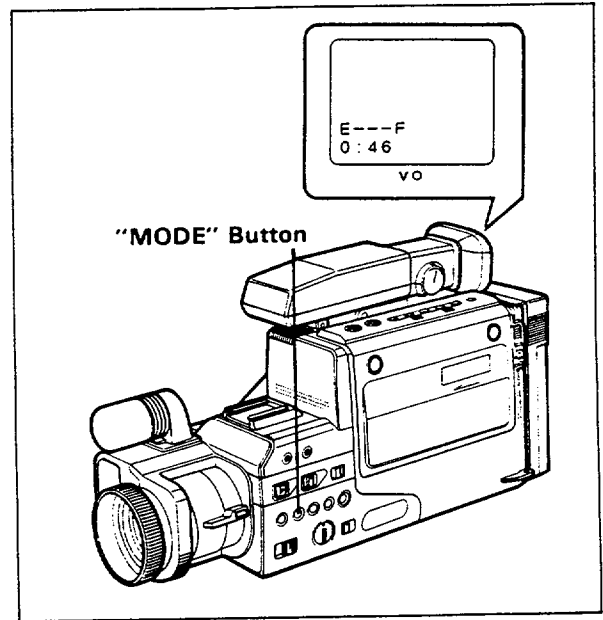

## TAPE DUBBING

If you wish to exchange or copy some of your friend's favorite home recordings, the following instructions can be used to connect one VTR to another for this purpose.

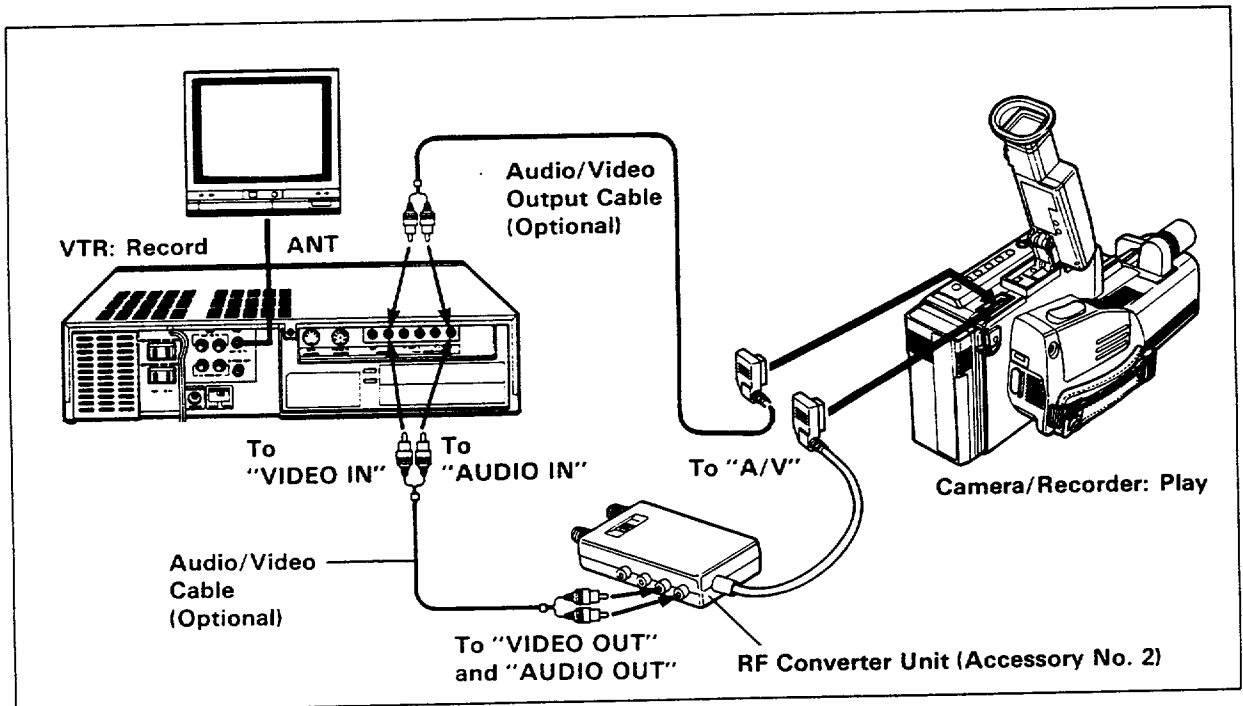

1. Connect the Audio/Video Connector Cable (Optional) to "VIDEO OUT" and "AUDIO OUT" on the RF Converter Unit.
2. Connect the other ends to "AUDIO IN", "VIDEO IN" on other VTR respectively.
3. Connect the Connector Cable from RF Converter Unit to "A/V" on Camera/Recorder.
4. Play the tape on Camera/Recorder and record it on VTR.

**NOTE:** If you play a tape with a VTR and record it with your Camera/Recorder, connect the "VIDEO IN"/"AUDIO IN" of RF Converter Unit to "VIDEO OUT"/"AUDIO OUT" of VTR.

## USING THE INSERT RECORDING FEATURE

Insert Recording is to insert new images onto a previously recorded tape. (Both the picture and sound are inserted simultaneously.) This is specially convenient to record titles on a previously recorded tape using the built-in camera section.

1. Play back the tape you intend to insert new images. (See pages 22 and 23 for playback operation.)
2. Press the **"MODE"** Button to display the tape counter in the Viewfinder.
3. At the point where Insert Recording is to end, press the **"RESET"** and **"MEMORY"** Buttons. The tape counter is reset to **"0000"** and **"M"** appears next to the counter reading.

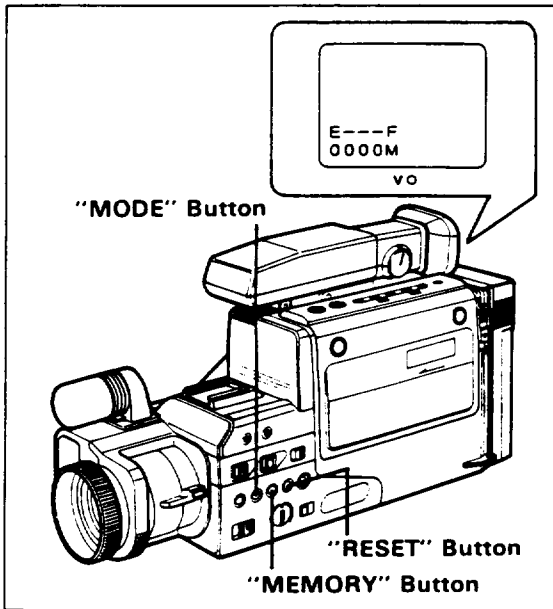

7. Set the **"VTR/CAMERA"** Select Switch to **"CAMERA"**.

The picture from the built-in camera appears on the TV screen.

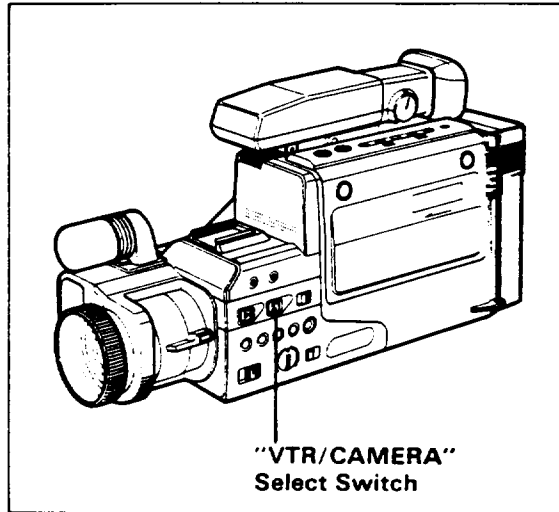

8. Press the Record Start/Stop Button on the grip or **"PAUSE"** Button on the top panel to start Insert Recording. The Camera/Recorder will stop at counter reading **"0000"**.

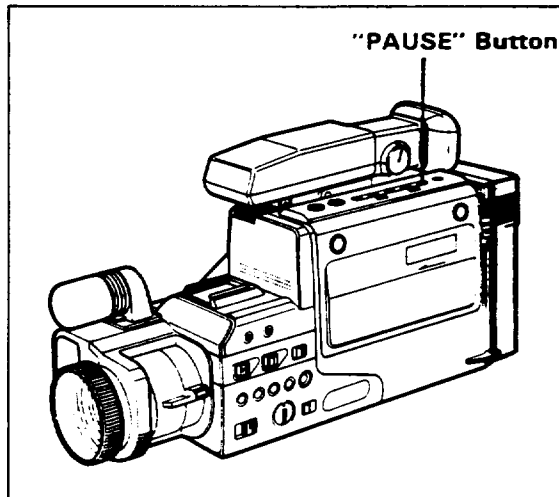

4. Press the **"REW"**ind Button to rewind tape. The Camera/Recorder enters the R-Search mode (described on page 26).
5. Press the **"PLAY"** Button at a point a few seconds before where Insert Recording is to begin then press the **"PAUSE"** Button. A still playback picture appears on TV screen.
6. Press the **"INSERT"** Button. The Camera/Recorder enters Insert Record Pause mode.

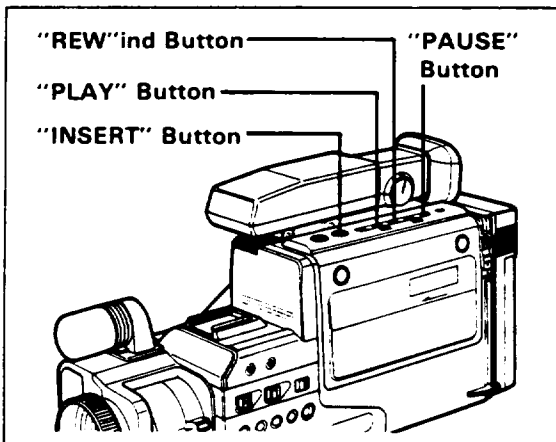

You can also insert video/audio from another VTR. Connect the video/audio signals from the VIDEO/AUDIO output jacks of the other VTR to the A V jack on the Camera/Recorder using the RF Converter Unit or optional Audio/Video Output Cable. Then follow above steps 1 through 6 and press the **"PAUSE"** Button on top panel. Insert Recording starts and stops at counter reading **"0000"**.

## HEAD CLEANING

- Picture playback may become blurred or be interrupted. This does not mean that the recorded program has been erased.
- Dirt accumulated on the head after long periods of use causes this problem. In this case, head cleaning requiring highly technical care is necessary.
- For head cleaning, consult the nearest dealer or VTR Service Center for recommendations.

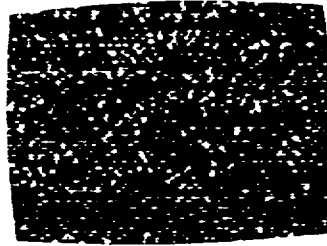

## PERIODIC MAINTENANCE

The Video Camera/Recorder is a precision electromechanical device which will require periodic maintenance after a period of normal use. We expect that no maintenance other than head cleaning will be required during the warranty period by most users, unless the Video Camera/Recorder is heavily used or seldom used. Normal maintenance is the responsibility of the user, although defective parts are covered during the warranty period. Consult your VTR Service Center to determine recommendations for normal maintenance based on your location, hours of use and age of Video Camera/Recorder.

## SPECIFICATIONS

### ■ General

Power requirements	7.2V DC
Power consumption	7 watts (nominal)
Dimensions	3-7/8"(W) x 5-13/16"(H) x 9-3/4"(D) 99(W) x 148(H) x 247(D) mm
Weight	2.4 lbs (1.1 kg)

### ■ Video Recorder Section

Format	8mm
Heads	3 video heads: 2 for record/playback, 1 for special effects 1 flying erase head
Video signal	EIA standard NTSC color
Tape speed	14.3 mm/sec.
Video input	1.0 Vp-p, 75 ohm
Video output	1.0 Vp-p, 75 ohm
Audio input	-7.8 dBs (316 m Vrms), more than 47K ohms
Audio output:	-7.8 dBs (316 m Vrms), less than 1.5K ohms
Fast forward/rewind time	Approx. 6 minutes with P6-120 cassette

### ■ Camera Section

Scanning	525 lines/60 fields/30 frames
Required minimum illumination	7 lux
Image Sensor	1/2" CCD
Lens diameter	46 mm (at the front of lens hood)

## TROUBLESHOOTING

Your Video Camera/Recorder is a highly sophisticated instrument. It has been carefully checked and adjusted at the factory under the most rigid quality control and inspection systems. However, should problems develop, check the following points and take necessary corrective measures.

### INSERTING OR REMOVING THE CASSETTE

Symptom	Check Point & Correction
Cassette Holder cannot be opened when you slide "EJECT" Button.	<ul style="list-style-type: none"> <li>• Connect the Power Source.</li> <li>• Turn the power on.</li> </ul>
Cassette cannot be inserted into Cassette Compartment.	<ul style="list-style-type: none"> <li>• Load cassette in direction indicated by arrow on cassette.</li> </ul>

### CAMERA RECORDING

Symptom	Check Point & Correction
Picture does not appear in the Viewfinder.	<ul style="list-style-type: none"> <li>• Remove the Lens Cap.</li> </ul>
	<ul style="list-style-type: none"> <li>• Set "POWER" ON/OFF Switch on.</li> </ul>
	<ul style="list-style-type: none"> <li>• Set "VTR/CAMERA" Switch to "CAMERA" position.</li> </ul>
The Camera/Recorder will not go into the recording mode, even when Record Start/Stop Button is pressed.	<ul style="list-style-type: none"> <li>• Check Safety Tab on the bottom of cassette. See page 5 for detail.</li> </ul>
	<ul style="list-style-type: none"> <li>• Set "VTR/CAMERA" Switch to "CAMERA" position.</li> </ul>
	<ul style="list-style-type: none"> <li>• The Indicator Lamp in the Electronic Viewfinder flashes to indicate Battery is discharged. Try another Battery or charge the Battery.</li> </ul>

### RECORDING TV PROGRAMS OFF THE AIR

Symptom	Check Point & Correction
The Camera/Recorder will not go into the recording mode, even when "RECORD" Button is pressed.	<ul style="list-style-type: none"> <li>• Check Safety Tab on the bottom of cassette. See page 5 for detail.</li> </ul>
	<ul style="list-style-type: none"> <li>• Set "VTR/CAMERA" Switch to "VTR" position.</li> </ul>
	<ul style="list-style-type: none"> <li>• The Indicator Lamp in the Electronic Viewfinder flashes to indicate Battery is discharged. Try another Battery or charge the Battery.</li> </ul>



## PLAYBACK OF PRE-RECORDED CASSETTE

Symptom	Check Point & Correction
"PLAY" Button cannot be engaged.	* Set "VTR/CAMERA" Switch to "VTR" position.
No picture appears on television screen when "PLAY" Button is pressed. (TV is connected to the Camera/Recorder by using RF Converter Unit.)	* Set the television to the Camera/Recorder channel (3 or 4) depending upon the selected channel on the RF Channel Select Switch of RF Converter Unit.
Interference on playback picture.	* When you see the playback picture on your TV, adjust fine tuning knob on television set to obtain best picture.
Picture bends at the top of TV screen.	* Tape is damaged. Try another cassette.
Color of your TV screen is too bright, too faint or change.	* TV set has VIR circuit. Turn it off during playback.

## DEW LIGHT

Symptom	Check Point & Correction
"DEW (POWER)" Light flashes.	* Condensation on the Camera/Recorder mechanism – wait until the Unit has reached normal room temperature, and condensation has dried. "DEW (POWER)" Light will then stop flashing.

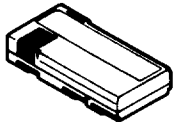
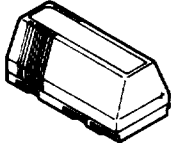
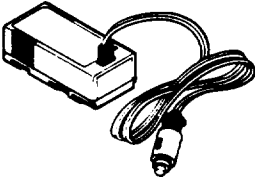
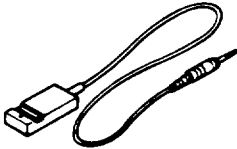
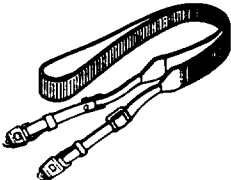
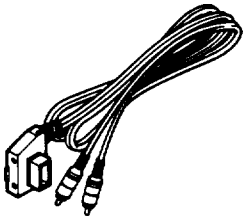
# OPTIONAL ACCESSORIES

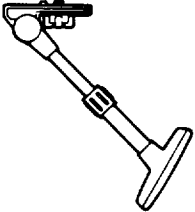
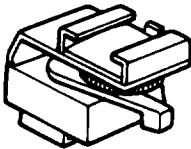
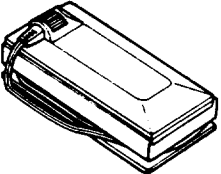
<p><b>Battery Pack (1 hour type) PV-BT810</b></p> 	<p><b>Battery Pack (2 hour type) PV-BT820</b></p> 	<p><b>Car Battery Adaptor PV-YC800A</b></p> 	<p><b>Remote Pause Switch PV-RM800</b></p> 
<p><b>Shoulder Strap PV-ZS800</b></p> 	<p><b>Audio/Video Output Cable PV-YK800</b></p> 	<p><b>Carrying Case PV-Z850</b></p> 	<p><b>Soft Case PV-Z860</b></p> 
<p><b>Camera Holder PC-Y800</b></p> 	<p><b>Accessory Shoe Adaptor PV-YS850</b></p> 	<p><b>Battery Connector PV-YA850</b></p> 	

## PENTAX

PENTAX CORPORATION. 35 Inverness Drive East Englewood, CO 80112  
Service information : (303) 799-8000

PENTAX CORPORATION. 1101 Stewart Ave. Garden City, NY 11530  
Service information : (516) 222-0830

PENTAX CORPORATION. 350 East Devon Ave. Itasca, IL 60143  
Service information : (312) 250-9000

PENTAX CORPORATION. 8363 Reseda Blvd. Northridge, CA 91324  
Service information : (818) 701-5060