

FCC STATEMENT (For customers in USA)

This device complies with Part 15 of the FCC Rules. Operation is subject to the following two conditions:

- (1) This device may not cause harmful interference, and
- (2) This device must accept any interference received, including interference that may cause undesired operation.

Note:

This equipment has been tested and found to comply with the limits for Class B digital devices, pursuant to Part 15 of the FCC rules. These limits are designed to provide reasonable protection against harmful interference in a residential installation. This equipment generates, uses and can radiate radio frequency energy and, if not installed and used in accordance with the instructions, may cause harmful interference to radio communications. However, there is no guarantee that interference will not occur in a particular installation. If this equipment does cause harmful interference to radio or television reception, which can be determined by turning the equipment off and on, the user is encouraged to try to correct the interference by one or more of the following measures:

- Reorient or relocate the receiving antenna.
- Increase the separation between the equipment and receiver.
- Connect the equipment into an outlet on a circuit different from that to which the receiver is connected.
- Consult the dealer or an experienced radio/TV technician for help.

Use of shielded cable is required to comply with Class B limits in Subpart B of Part 15 of the FCC rules. Do not make any changes or modifications to the equipment unless otherwise specified in the manual. If such changes or modifications should be made, you could be required to stop operation of the equipment.

For customers in Canada

This Class B digital apparatus meets all requirements of the Canadian Interference - Causing Equipment Regulations.

Pour les utilisateurs au Canada

Cet appareil numérique de la classe B respecte toutes les exigences du Règlement sur le matériel brouilleur du Canada.

READ THIS FIRST

Trademark Information

- PENTAX and Optio are trademarks of PENTAX Corporation.
- QuickTime and QuickTime logo are trademarks used under license. The QuickTime logo is registered in US and other countries.
- This product supports PRINT Image Matching III. PRINT Image Matching enabled digital still cameras, printers and software help photographers to produce images more faithful to their intentions. Some functions are not available on printers that are not PRINT Image Matching III compliant. Copyright 2001 Seiko Epson Corporation. All Rights Reserved. PRINT Image Matching is a trademark of Seiko Epson Corporation.
The PRINT Image Matching logo is a trademark of Seiko Epson Corporation.
- SD logo () is a trademark.
- All other brands or product names are trademarks or registered trademarks of their respective owners.



Product Information

- Product design and specifications are subject to change without notice. This includes primary product specifications, software, software drivers, and user's manual. This User Manual is a general reference guide for the product.
- The product and accessories that come with your digital camera may be different from those described in this manual. This is due to the fact that different retailers often specify slightly different product inclusions and accessories to suit their market requirements, customer demographics, and geographical preferences. Products very often vary among retailers especially with accessories such as batteries, chargers, AC adapters, memory cards, cables, carrying cases/pouches, and language support. Occasionally a retailer will specify a unique product color, appearance, and internal memory capacity. Contact your dealer for precise product definition and included accessories.
- The illustrations in this manual are for the purpose of explanation and may differ from the actual design of your digital camera.
- The manufacturer assumes no liability for any errors or discrepancies in this user manual.
- For user manual and driver updates, refer to our website or contact your dealer.

SAFETY INSTRUCTIONS

Read and understand all **Warnings** and **Cautions** before using this product.

Warnings

If foreign objects or water have entered the camera, turn the power off and remove the batteries and the AC power adapter.

Continued use in this state might cause fire or electric shock. Consult the store of purchase.



If the camera has fallen or its casing has been damaged, turn the power off and remove the batteries and the AC power adapter.

Continued use in this state might cause fire or electric shock. Consult the store of purchase.



Do not disassemble, change or repair the camera.

This might cause fire or electric shock. For repair or internal inspection, ask the store of purchase.



Use the supplied AC adapter only with the indicated power supply voltage.

Use with any other power supply voltage might cause fire or electric shock.



Do not use the camera in areas near water.

This might cause fire or electric shock. Take special care during rain, snow, on the beach, or near the shore.



Do not place the camera on inclined or unstable surfaces.

This might cause the camera to fall or tilt over, causing injury.



Keep the batteries out of the reach of children.

Swallowing batteries might cause poisoning. If the battery is accidentally swallowed, immediately consult a physician.



Do not use the camera while you are walking, driving or riding a motorcycle.

This might cause you to fall over or result in traffic accident.



Cautions

Insert the batteries paying careful attention to the polarity (+ or -) of the terminals.

Inserting the batteries with its polarities inverted might cause fire and injury, or damage to the surrounding areas due to the battery rupturing or leaking.



Do not fire the flash close to anyone's eyes.

This might cause damage to the person's eyesight.



Do not subject the LCD monitor to impact.

This might damage the glass on the screen or cause the internal fluid to leak. If the internal fluid enters your eyes or comes into contact with your body or clothes, rinse with fresh water. If the internal fluid has entered your eyes, consult a physician to receive treatment.



A camera is a precision instrument. Do not drop it, strike it or use excessive force when handling the camera.

This might cause damage to the camera.



Do not use the camera in humid, steamy, smoky, or dusty places.

This might cause fire or electric shock.



Do not remove the battery immediately after long period of continuous use.

The battery becomes hot during use. Touching a hot battery might cause burns.



Do not wrap the camera or place it in cloth or blankets.

This might cause heat to build up and deform the casing, resulting in fire. Keep the camera in a well-ventilated place.



Do not leave the camera in places where the temperature may rise significantly, such as inside a car.

This might adversely affect the casing or the parts inside, resulting in fire.



Before you move the camera, disconnect cords and cables.

Failure to do this might damage cords and cables, resulting in fire and electric shock.



Notes on Battery Usage

When you use the battery, carefully read and strictly observe the **Safety Instructions** and the notes described below:

- Different battery types and surrounding temperatures may affect the battery performance.
- Avoid using batteries in extremely cold environments as low temperatures can shorten the battery life and reduce camera performance. This low temperature will also influence Alkaline battery performance, therefore Ni-MH rechargeable battery is highly recommended.
- Using new rechargeable batteries for the first time, or rechargeable batteries that have not been used for an extended period of time might affect the number of pictures that can be taken. Therefore, to maximize their performance and lifetime, we recommend that you fully charge such batteries and discharge them for at least one complete cycle before use. Nevertheless, batteries whose expiry date has passed could not be restored by this procedure.
- The battery may feel warm when using the camera for an extended period of time or using the flash continuously. This is normal and not a malfunction.
- The camera may feel warm when being used continuously or for an extended period of time. This is normal and not a malfunction.
- If you will not be using the batteries for an extended period of time, remove them from the camera to prevent leakage or corrosion.
- Never use batteries of different types (together) or mix old and new batteries.
- Always keep the terminals in a clean state.
- Never use manganese batteries.
- Risk of explosion if battery is replaced by an incorrect type.
- Dispose of used batteries according to the instructions.

CONTENTS

INTRODUCTION	8	PHOTOGRAPHY MODE.....	24
Package Contents.....	9	Shooting Images - The Basics.....	24
GETTING TO KNOW YOUR CAMERA.....	10	Setting Image Resolution and Quality	25
Front View.....	10	Using the Zoom Function.....	26
Rear View.....	11	Using the Flash.....	27
Mode Dial	12	Setting Focus.....	28
LCD Monitor Information.....	13	Using the Self-Timer.....	29
PREPARING THE CAMERA.....	15	Adjusting the Exposure (EV Compensation).....	30
Installing the Batteries (Optional Accessory)	15	Setting White Balance.....	31
Using the AC Power Adapter (Optional Accessory).....	16	USING THE MODE DIAL.....	32
Inserting and Removing an SD Memory Card (Optional Accessory)	17	Simple Mode.....	32
Attaching the Camera Strap.....	18	Program Mode	32
LED Indicators.....	18	Picture Mode.....	33
GETTING STARTED.....	19	Aperture Priority Mode.....	33
Turning the Power On/Off	19	Shutter Speed Priority Mode.....	34
Choosing the Screen Language.....	20	Manual Mode.....	34
Setting the Date and Time	21	ADVANCED SHOOTING.....	35
Formatting an SD Memory Card or Internal Memory.....	22	High Speed Continuous.....	35
Using the LCD Monitor.....	23	Auto Bracket	36
		Selecting the Metering Mode	37

PLAYBACK MODE - THE BASICS.....	38	EDITING SOFTWARE INSTALLATION.....	58
Viewing Images	38	Installing ACDSee for PENTAX.....	58
Magnifying Images	39	USING THE DIGITAL CAMERA AS A PC CAMERA...59	
Thumbnail Display	40	Step 1: Install the PC camera driver.....	59
Slideshow Display	41	Step 2: Connect the digital camera to your	
Resizing an Image	42	computer.....	60
MOVIE MODE.....	43	Step 3: Run your application software	
Recording Movie Clips	43	(i.e. Windows NetMeeting).....	60
Playing Back Movie Clips	44	MENU OPTIONS.....	61
PLAYBACK MODE – ADVANCED FEATURES...45		Camera Menu.....	61
Playing Back Still Images/Movie Clips on TV	45	Movie Menu	65
Deleting Images/Movie Clips.....	46	Playback Menu.....	66
Protecting Images/Movie Clips	47	Setup Menu.....	68
Setting the DPOF.....	48	CONNECTING THE DIGITAL CAMERA TO	
Connecting to a PictBridge-Compatible Printer.....	50	OTHER DEVICES.....	71
TRANSFERRING FILES FROM YOUR DIGITAL		SPECIFICATIONS.....	72
CAMERA TO COMPUTER.....	54	APPENDIX.....	73
Step 1: Install the USB driver	55	WARRANTY POLICY.....	76
Step 2: Connect the digital camera to your			
computer.....	56		
Step 3: Download images or movie clips.....	57		

INTRODUCTION

Thank you for purchasing this new digital camera!

Equipped with a 6.0 Megapixels CCD sensor, your camera delivers high quality, 2848 x 2136 resolution images. Other features provided by the camera include the following:

■ 6.0 Megapixels

A high-resolution CCD sensor provides 6.0 megapixels for high quality of images.

■ Auto flash

An auto flash sensor automatically detects the shooting (lighting) conditions and determines whether the flash should be used.

■ 2.0" LTPS color image LCD monitor

■ Optical zoom: 1x~3x

■ Digital zoom: 1x~4x

■ Approx. 12MB internal (built-in) memory

Images can be captured without using a memory card.

■ Support for SD memory card for memory expansion

You may wish to expand the memory capacity (up to 1GB capacity) by using an additional memory card.

■ USB connection (USB 2.0 Full Speed)

Still images or movie clips that you have recorded can be downloaded to your computer using the USB cable (A USB driver is required for Win 98 and Win98SE).

■ DPOF functionality

DPOF can be used to print your images on a DPOF compatible printer by simply inserting the memory card.

■ PictBridge support

You can connect the camera directly to printer that supports PictBridge and perform image selection and printing using the camera monitor screen and controls.

■ Provided editing software: ACDSee for PENTAX

You can enhance and retouch your images on your computer by using the provided editing software.

Package Contents

Carefully unpack your kit box and ensure that you have the following items. In the event that any item is missing or if you find any mismatch or damage, promptly contact your dealer.

Common Product Components:

- Digital Camera
- Operating manuals
- Quick Start Guide
- USB Cable
- Software CD-ROM (S-SW38)
- AV Cable
- Camera Strap
- Two AA alkaline batteries (for checking the camera's functionality)

Common (Optional) Accessories (not included with the camera):

- AC power adapter (supplied by PENTAX)
- SD memory card (commercially available)
- Battery Charger (commercially available)



- Accessories and components may vary by retailer.

GETTING TO KNOW YOUR CAMERA

Front View

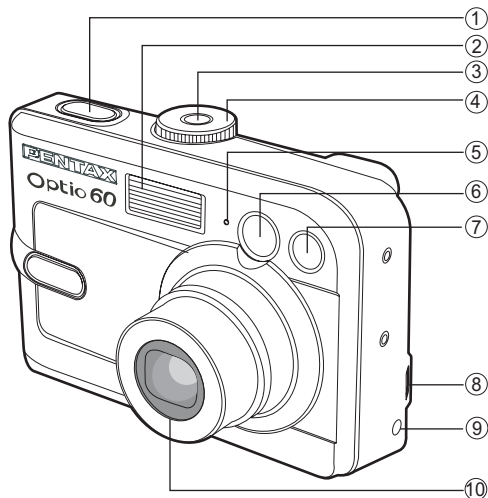

1. Shutter button

2. Flash

3.  Power button

4. Mode dial

5. Microphone

6. Viewfinder window

7. Self-timer LED

8. PC (USB) / AV terminal

9. DC IN 3V terminal

10. Lens

Rear View

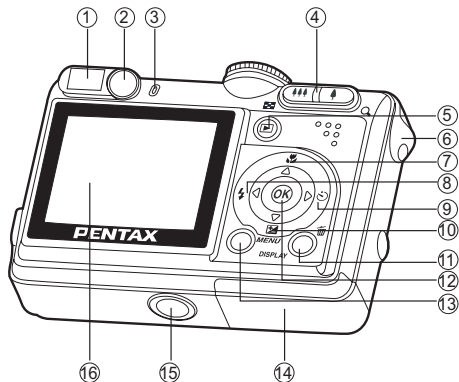

- | | |
|-----------------------------------|-----------------------------------|
| 1. Viewfinder | 9. Arrow button (Right) |
| 2. Diopter adjustment dial | Self-timer button |
| 3. Viewfinder LED | 10. Arrow button (Down) |
| 4. / Zoom in (telephoto) button | Exposure compensation button |
| Zoom out (wide-angle) button | 11. DISPLAY Display button |
| Thumbnail button | Delete button |
| 5. Playback button | 12. OK button |
| 6. Strap holder | 13. MENU Menu button |
| 7. Arrow button (Up) | 14. Battery / SD card cover |
| Macro button | 15. Tripod socket |
| 8. Arrow button (Left) | 16. LCD monitor |
| Flash button | |

Mode Dial

You can select from seven shooting modes and setup mode according to shooting conditions to achieve the desired effect.

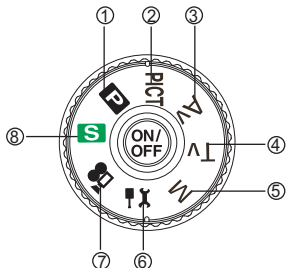

	Mode	Description
1.	P Program	Select this mode to permit the shutter speed and aperture to be set automatically.
2.	PICT Picture	Select this mode to select the Picture mode according to the shooting scene.
3.	Av Aperture priority	Select this mode to specify the aperture value while the camera sets the corresponding shutter speed.
4.	Tv Shutter speed priority	Select this mode to specify the shutter speed while the camera sets the corresponding aperture.
5.	M Manual	Select this mode to permit full manual control over exposure, aperture and other settings.
6.	fx Setup	Select this mode to adjust the camera settings.
7.	Movie Movie	Select this mode to record movie clips.
8.	S Simple	Select this mode for point-and-shoot action.

LCD Monitor Information

■ Camera Mode

1. Flash mode

- [] Auto
- [] Auto + Red-eye reduction
- [] Flash on
- [] Flash off

2. Mode indication

- [] Simple mode
- [] Setup mode
- [] Movie mode
- [] Aperture priority mode
- [] Program mode
- [] Shutter speed priority mode

3. Image quality

- [] Best
- [] Better
- [] Good

4. Recorded Pixels

- [] 2848 x 2136
- [] 2272 x 1704
- [] 1600 x 1200
- [] 640 x 480

5. Possible number of shots

6. Memory status

- [] : Built-in memory (without card)
- [] : SD Memory Card

7. Remaining battery status

- [] Full battery power
- [] Medium battery power
- [] Low battery power
- [] No battery power

8. Self-timer mode

- [] 2 sec. delay
- [] 10 sec. delay
- [] 10+2 sec. delay
- [] Timer off

9. White balance

- [No icon] Auto
- [] Daylight
- [] Cloudy
- [] Tungsten light
- [] Fluorescent light

10. Drive mode

- [] Standard
- [] HS Continuous
- [] Auto Bracket

11. Focus area

- [] Macro
- [] Infinity
- [**Std.**] Auto focus

12. Date

13. Focus mode

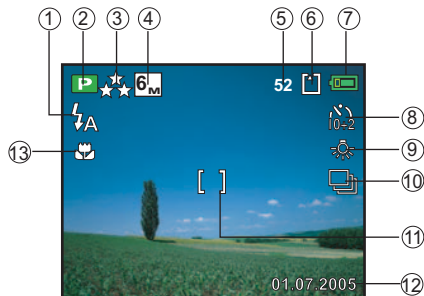

■ Movie Mode

1. Movie mode
2. Recordable movie time available
3. Memory status
4. Battery power indicator
5. Focus area
6. Flash mode
7. Date

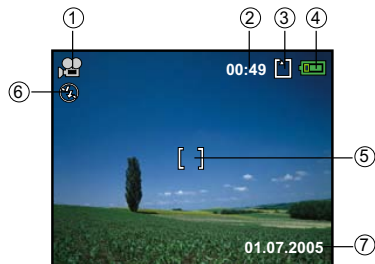

■ Image Playback

1. Playback mode
2. Memory status
3. Battery power indicator
4. Playback information

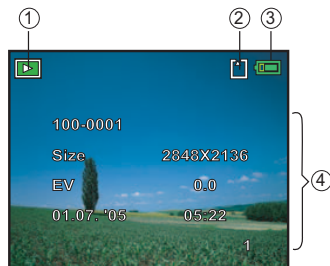

■ Movie Playback

1. Playback mode
2. Movie mode
3. Memory status
4. Battery power indicator
5. Playback information
6. Playback indicator

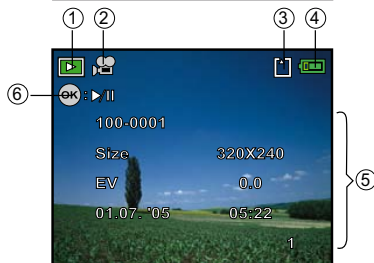

PREPARING THE CAMERA

Installing the Batteries (Optional Accessory)

You can use 2 AA size batteries (alkaline or Ni-MH rechargeable) to power the camera. Make sure that the power of the digital camera is off before inserting or removing the batteries.

1. Make sure the camera is turned off.
2. Open the battery cover.
3. Insert the batteries in the correct orientation as shown in the illustration.
4. Close the battery cover.
 - To remove the batteries, turn the camera off before removing batteries and hold the camera with the battery cover facing upward, then open the battery cover.

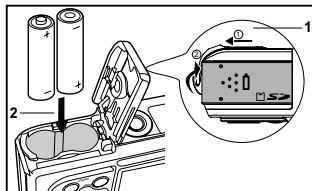

- Be careful not to drop the batteries when opening or closing the battery cover.
- Due to the characteristics of AA alkaline battery, camera performance may deteriorate. AA alkaline battery is not recommended except in emergencies and checking the camera's functionality.

Using the AC Power Adapter (Optional Accessory)

Use of the AC power adapter is recommended if you intend to use the LCD monitor for a long time or connect the camera to a PC.

1. Make sure your camera is turned off.
2. Connect one end of the AC power adapter to the camera jack labeled "DC IN 3.0V".
3. Connect the other end to an electrical outlet.

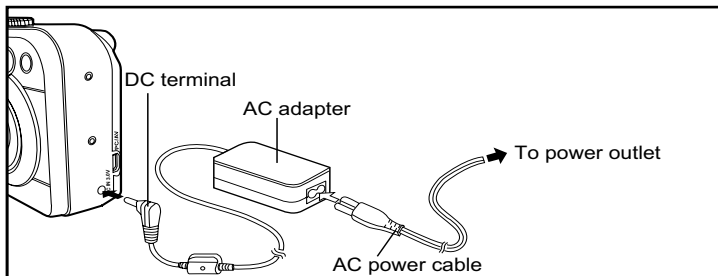

- Make sure to use only the AC power adapter specified for the camera. Damage caused by the use of an incorrect adapter is not covered under the warranty.
- To prevent unexpected auto power off resulting from no battery power left during the process of transferring your images to the computer, use the AC power adapter as a power supply.
- The AC power adapter can only be used to power the camera. Batteries cannot be charged inside the camera.

Inserting and Removing an SD Memory Card (Optional Accessory)

The digital camera comes with approx. 12MB of internal memory, allowing you to store captured still images or movie clips in the digital camera. Moreover, you can also expand the memory capacity by using an optional SD (Secure Digital) memory card so that you can store more files.

1. Make sure your camera is turned off before inserting or removing an SD card.
2. Open the SD card cover.
3. Insert an SD card in the correct orientation as shown in the illustration.
4. Close the SD card cover.
 - To remove the SD card, make sure the camera is turned off. Press lightly on the edge of the memory card and it will eject.

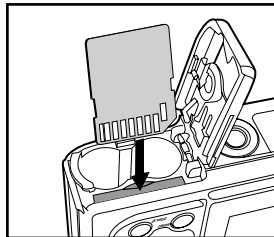

- Be sure to format an SD memory card with this digital camera before using it. Refer to section in the manual titled “**Formatting an SD Memory Card or Internal Memory**”. (Refer to EN-22 for further details.)
- To prevent valuable data from being accidentally erased from an SD card, you can slide the write protect tab (on the side of the SD memory card) to “LOCK”.
- To save, edit, or erase data on an SD memory card, you must unlock the card.

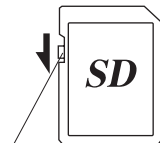

Write-protect switch

Attaching the Camera Strap

Attach the strap as shown in the illustration.

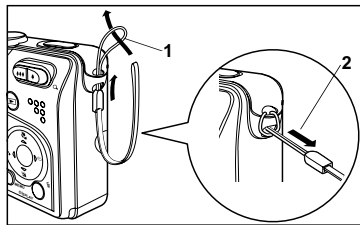



LED Indicators

Indicator	State	Description/Activity
LED indicator	Solid red	The digital camera is powered up.
LED indicator	Solid green	The digital camera is ready to record images (or movies).
LED indicator	Blinking red	USB communication/transfer in progress.
LED indicator	Blinking red	Charging the flash.
Self-timer indicator	Blinking green	The self-timer function is activated.

GETTING STARTED

Turning the Power On/Off

- Press the  button until the digital camera turns on.
- To turn the power off, press the  button again.

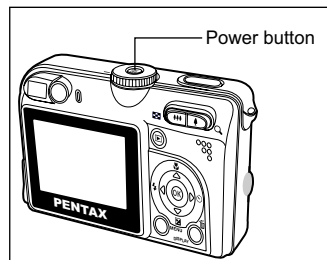

Setting the Date and Time

Follow the steps below to set the date display style, current date and time.

1. Rotate the mode dial to **1X** and turn your camera on by pressing the **ON** button.
 - The [Set-up1] menu is displayed.
2. Use **▼** to select [Date Adjust], then press the **OK** button.
 - You may press **◀** or **▶** to switch the date types.
3. Press **◀** or **▶** to select Year, Month, Day and Time fields.
 - To increase a value, press **▲**.
 - To decrease a value, press **▼**.
 - The time is displayed in 24-hours format.
4. Press the **ON** button after all fields are set.

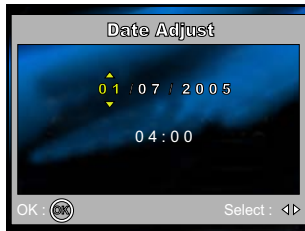

- The date illustration shown is for the purpose of explanation and may differ from the actual setting of your camera.

Formatting an SD Memory Card or Internal Memory

The term “Formatting” means preparing an “SD Memory Card” to record images; this process is also called “initialization”. This utility formats the internal memory (or memory card) and erases all stored images and data.

1. Rotate the mode dial to **FX** and turn your camera on by pressing the **ON** button.
 - The [Set-up1] menu is displayed.
2. Use **▼** to select [Format], then press the **OK** button.
3. Use **▲** or **▼** to select [OK], then press the **OK** button to confirm.



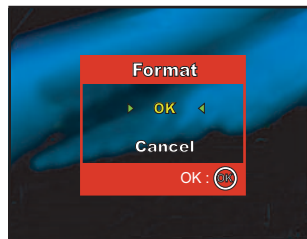

- When you format an SD memory card, be aware that all data will be permanently erased. Protected images are also erased.
- To format the internal memory, do not insert a memory card into the camera. Otherwise, you will format the memory card.
- Formatting is an irreversible action and data cannot be recovered at a later time.
- An SD memory card having any problem cannot be properly formatted.



Using the LCD Monitor

Your camera is equipped with a 2.0" full color TFT LCD monitor to help you compose images, replay recorded images/movie clips or adjust menu settings. The mode icons, text and numbers displayed on the monitor may vary according to the current settings.

1. Rotate the mode dial to **S**, **P**, PICT, Av, Tv, M or .
2. Press the  button to turn on the power.
3. Compose your scene on the LCD monitor.
4. Press the shutter button.

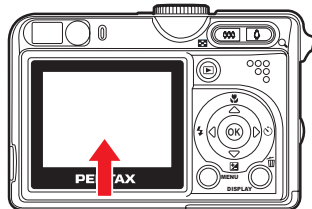

- The LCD monitor darkens in strong sunlight or bright light. This is not a malfunction.
- To prevent your images from being blurred while pressing the shutter button, always hold it carefully. This is especially important when you are shooting under low lighting conditions, since your camera may decelerate the shutter speed to ensure your images are properly exposed.

PHOTOGRAPHY MODE

Shooting Images - The Basics

1. Rotate the mode dial to **S**, **P**, PICT, Av, Tv or M and turn your camera on by pressing the  button.
2. Compose the image on the monitor screen so that the main subject is within the focus frame.
3. Press the shutter button down half way to focus the image.
 - When you press the shutter button down half way, the camera's Auto Focus feature automatically focuses the image. Proper exposure is determined and locked at the same time.
4. Press the shutter button the rest of the way down to capture the image.

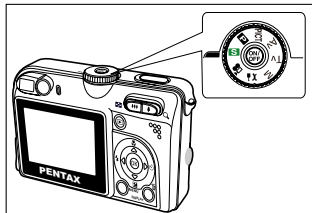

- The actual captured image appears to be larger than the one displayed by the LCD after the image has been captured.
- Pressing the **DISPLAY** button switches the LCD monitor display mode. Each time you press the **DISPLAY** button, the display changes in the following order: Focus Frame On → Indicators Off → Composition Line On → LCD Off.

Setting Image Resolution and Quality

As you get to know the digital camera, you can set the image resolution (number of vertical and horizontal pixels) and image quality (compression ratio) based on the types of images you want to shoot. These settings affect the number of images that can be stored in the internal memory, or on a memory card.

Higher resolution and higher quality images provide finer detail but cause the images' file size to be larger.

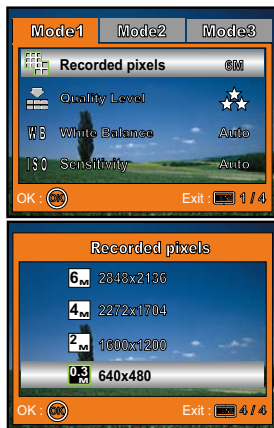

To change image resolution or image quality, perform these steps below:

1. Rotate the mode dial to **S**, **P**, PICT, Av, Tv or M and turn your camera on by pressing the button.
2. Press the **MENU** button.
 - The [Mode1] menu is displayed. In the **S** mode, [Simple] menu is displayed.
3. Use to select [Recorded pixels], then press the button.
4. Use or to select the desired setting, then press the button to confirm.
5. Follow the step 3 and 4 above to set the [Quality Level].







- The possible number of shots and recording time depend on the storage size, resolution and quality settings and the subject of the image to be captured.
- You can resize the images later. Please refer to the section in this manual titled “Resizing an Image”. (Refer to EN-42 for further details.)

Using the Zoom Function

This camera is equipped with 3x optical zoom. The lens moves during the optical zoom photography, allowing you to capture telephoto and wide-angle shots. By using the optical zoom function; images appear closer by pressing the , or smaller away by pressing the .

Moreover, you can further enlarge the subjects with 4x digital zoom by pressing continuously the  button. It is activated after your camera reaches its maximum optical zoom factor (3x). A useful feature as it is, however, the more the image is enlarged, the more pixelated the image will appear.

To capture a zoomed image, perform the following steps:



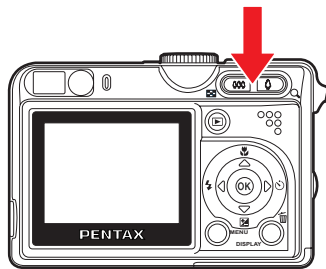

1. Rotate the mode dial to **S**, **P**, PICT, Av, Tv or M and turn your camera on by pressing the  button.
2. Adjust the magnification ratio by using the  /  button.
 - To access the optical zoom function, press the  button as far as it can go. Press it again to activate the digital zoom.
 - To exit the zoom photography, press continuously the  button.
 - The status of digital magnification is displayed on the LCD monitor.
3. Compose your scene and press the shutter button.



- To enable digital zoom feature, set the [Mode2- Digital Zoom] to [On] in the **P**, PICT, Av, Tv or M mode. (Refer to EN-63 for further details.)





Using the Flash

The flash is designed to function automatically when lighting conditions warrant the use of flash. You can take an image using a desired flash mode to suit your circumstances.



1. Rotate the mode dial to **S**, **P**, PICT, Av, Tv or M.
2. Press the  button to turn on the power.
3. Press  / .
4. Use  or  to select the desired flash mode.
5. Compose your scene and press the shutter button.







The table below will help you to choose the appropriate flash mode:

Flash mode	Description
 Auto	The flash fires automatically according to suit the photographic conditions.
 Auto + Red-eye reduction	Use this mode to reduce the red-eye phenomenon when you want to take natural-looking photographs of people and animals in low-light conditions. When taking photographs, the red-eye phenomenon can be reduced by asking the subject (person) to look at the digital camera or get as close to the digital camera as possible.
 Flash on	The flash will always fire regardless of the surrounding brightness. Select this mode for recording images with high contrast (backlighting) and deep shadows.
 Flash off	Use this mode where the flash use is prohibited or when the distance to the subject is too far away for the flash to have any effect.



Setting Focus

Images can be captured with the focus determined automatically using auto focus. You may over-ride the auto focus and specify [] macro or [] infinity.

1. Rotate the mode dial to **S**, **P**, PICT, Av, Tv or M.
2. Press /.
3. Use  or  to select the desired focus mode.
4. Compose your scene and press the shutter button.







The table below will help you choose the appropriate focus mode:

Focus mode	Description
 Macro	Select macro to capture close-up images. When the lens is zoomed to its widest position you may focus objects as close as 5 cm. When the lens is zoomed to its telephoto position (3x zoom) you may focus objects as close as 30 cm.
 Infinity	Select the infinity-focus setting when you want to capture images of subject at a distance of infinity.
Std. Auto Focus	Select auto focus for most occasions when you want the camera to automatically determine the focus setting. Using auto focus any object at a range of focus is 50 cm or greater can be in focus.





Using the Self-Timer

The self-timer can be used in situations such as group shots. When using this option, you should either mount the camera on a tripod (recommended) or rest it on a flat, level surface.

1. Secure the camera to a tripod or place it on a stable surface.
2. Rotate the mode dial to **S**, **P**, PICT, Av, Tv or M.
3. Press the  button to turn on the power.
4. Press /.
5. Use  or  to select the desired self-timer mode.
6. Compose your scene and press the shutter button.
 - The self-timer function is activated.
 - The photograph is then taken after the preset time.
 - To cancel the self-timer at any time, press the shutter button.



The table below will help you choose the appropriate self-timer mode:

Self-timer mode	Description
 Timer off	The self-timer is off.
 2 seconds	The image is captured about 2 seconds after the shutter is pressed. This mode is useful for preventing camera shake.
 10 seconds	The image is captured about 10 seconds after the shutter is pressed. This mode is suitable for the shots in which the photographer has to be included.
 10+2 seconds	The first image is captured about 10 seconds after the shutter button is pressed, and then the second image is captured 2 seconds later. This mode is convenient when capturing group images in succession.



- After one shot is taken, the self-timer mode is turned off.
- If you wish to take another image using the self-timer, repeat these steps.

Adjusting the Exposure (EV Compensation)





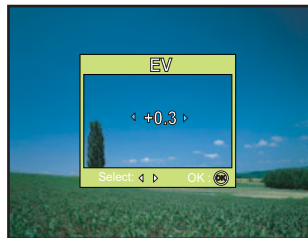

You can manually adjust the exposure determined by the digital camera. Use this mode when the proper exposure cannot be obtained, for example, when the contrast (difference between bright and dark areas) between the subject and the background is extremely high. The EV compensation value can be set in the range from -2.0EV to $+2.0\text{EV}$.

1. Rotate the mode dial to **P**, PICT, Av, Tv or M.
2. Press the **ON** button to turn on the power.
3. Press **▼**.
4. Use **◀** or **▶** to set the range of EV compensation value from -2.0EV to $+2.0\text{EV}$.
5. To exit the menu, press the **OK** button.



Setting White Balance

This feature lets you make adjustments to compensate for different lighting types according to your shooting conditions.

1. Rotate the mode dial to **P**, PICT, Av, Tv or M.
2. Press the  button to turn on the power.
3. Press the **MENU** button.
4. Use  to select [White Balance], then press the  button.
5. Use  or  to select the desired setting, then press the  button to confirm.
6. To exit the menu, press the **MENU** button.

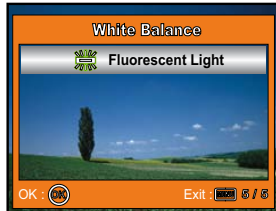
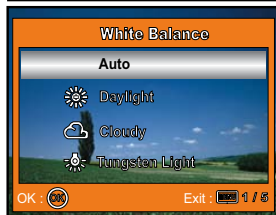
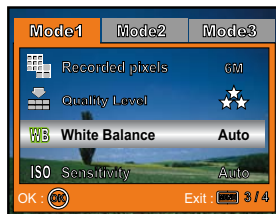

USING THE MODE DIAL

Simple Mode [S]

S (Simple) mode is the simplest way which allows you to take still pictures without having to set special functions or manual adjustments. The camera sets the optimal focusing and exposure.

1. Rotate the mode dial to **S** and turn your camera on by pressing the  button.
2. Compose your subject within the focus frame.
3. Press the shutter button down halfway to focus the image.
 - When you press the shutter button down half way, the camera's Auto Focus feature automatically focuses the image. Proper exposure is determined and locked at the same time.
4. Press the shutter button the rest of the way down to capture the image.

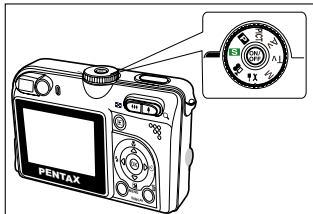

Program Mode [P]

In the **P** (Program) mode, the camera automatically sets the shutter speed and aperture for taking still images. You can adjust other functions, such as flash mode or continuous shooting mode.

1. Rotate the mode dial to **P** and turn your camera on by pressing the  button.
2. Compose your subject within the focus frame.
3. Press the shutter button to capture the image.

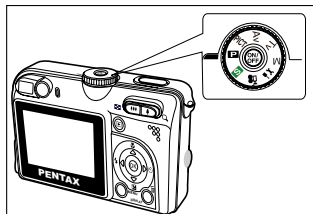



Picture Mode [PICT]





You can select the Picture mode according to the shooting scene. There are 4 available modes in Picture mode.

[] Night scene: This mode allows you to take photographs of people against a dusk or night-time background.

[] Landscape: This mode allows you to take photographs of distant scenery or landscapes.

[] Portrait: Select this mode to make people stand out with the background out-of-focus.

[] Sport: This mode allows you to shoot fast moving objects.



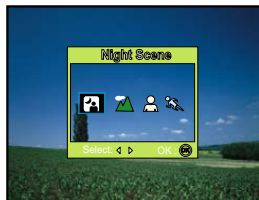

1. Rotate the mode dial to PICT and turn your camera on by pressing the  button. A guide appears for a few seconds.
2. Press the  button.
3. Use  or  to select the desired scene mode.
4. Press the  button to confirm the selection.
5. Compose your subject within the focus frame.
6. Press the shutter button to capture the image.



Aperture Priority Mode [Av]

In this mode, images are captured with the priority given to aperture. The shutter speed is automatically set according to the aperture. The aperture will affect the depth-of-field of the picture.





If you set a large aperture (lower F value), you can capture portrait images with an out-of-focus background. Alternatively, if you set a small aperture (higher F value), both close objects and distant objects will be in focus, for example when capturing subjects in the foreground together with landscape images.

1. Rotate the mode dial to Av and turn your camera on by pressing the  button. A guide appears for a few seconds.
2. Press the  button.
3. Set the aperture value with  or , and press the  button.
4. Compose your subject within the focus frame.
5. Press the shutter button to capture the image.



Shutter Speed Priority Mode [Tv]







If you set a fast shutter speed, you can capture images of moving subjects that look as if they are still. If you set a slow shutter speed, you can capture images that give the impression that the subject is in motion.

1. Rotate the mode dial to Tv and turn your camera on by pressing the  button. A guide appears for a few seconds.
2. Press the  button.
3. Set the aperture value with  or , and press the  button.
4. Compose your subject within the focus frame.
5. Press the shutter button to capture the image.



Manual Mode [M]

In manual mode, the aperture value and the shutter speed can be varied individually. This can be useful for compensating tricky lighting conditions, for getting creative results or for capturing night-time scenes.

1. Rotate the mode dial to M and turn your camera on by pressing the  button. A guide appears for a few seconds.
2. Press the  button.
3. Use  or  to select aperture/shutter speed item.
4. Adjust the value with  or , and press the  button.
5. Compose your subject within the focus frame.
6. Press the shutter button to capture the image.



- Press the shutter button halfway to confirm if the exposure is set correctly on the LCD monitor.

ADVANCED SHOOTING

High Speed Continuous

This mode is used for continuous shooting. 3 pictures are taken continuously once the shutter button is pressed.

1. Rotate the mode dial to **S**, **P**, PICT, Av, Tv or M and turn your camera on by pressing the button.
2. Press the **MENU** button, then use to select the [Mode2] menu.
 - In the **S** mode, press the **MENU** button.
3. Use to select [Drive Mode], then press the button.









4. Use or to select [HS Continuous], then press the button.
5. To exit the menu, press the **MENU** button.
 - The indicator is displayed on the monitor screen.
6. Press the shutter button halfway to lock the focus.
7. Press the shutter button to capture a sequence of images.



- In High Speed Continuous mode, the flash mode will be set to **OFF** automatically.

Auto Bracket

In this mode, the camera automatically changes the exposure within a set range to take three shots after you press the shutter button once. Auto Bracket settings can be combined with exposure compensation settings to extend the adjustment range.

1. Rotate the mode dial to **S**, **P**, **PICT**, **Av**, **Tv** or **M** and turn your camera on by pressing the  button.
2. Press the **MENU** button, then use  to select the [Mode2] menu.
 - In the **S** mode, press the **MENU** button.
3. Use  to select [Drive Mode], then press the  button.
4. Use  or  to select [Auto Bracket], then press the  button.
5. To exit the menu, press the **MENU** button.
 - The  indicator is displayed on the monitor screen.
6. Press the shutter button to capture the three images.

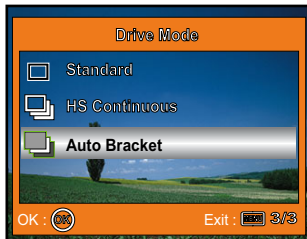

- In Auto Bracket mode, the flash mode will be set to **OFF** automatically.

Selecting the Metering Mode

You can select the metering mode that sets which part of the subject to measure to determine the exposure.

1. Rotate the mode dial to **P**, **PICT**, **Av**, **Tv** or **M** and turn your camera on by pressing the **ON** button.
2. Press the **MENU** button, then use **▶** to select the [Mode2] menu.
3. Use **▼** to select [AE Metering], then press the **OK** button.
4. Use **▲** or **▼** to select the desired metering mode, then press the **OK** button.
 - [**☉** Center-Weighted]: Averages the light metered from the entire frame, but gives greater weight to the subject matter at the center.
 - [**□** Spot]: The exposure is determined by the small area in the center of the screen only.
5. To exit the menu, press the **MENU** button.
6. Compose your subject within the focus frame.
7. Press the shutter button to capture the image.

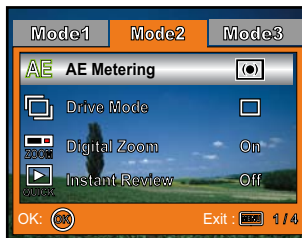

PLAYBACK MODE - THE BASICS

Viewing Images

You can display the still images one by one.



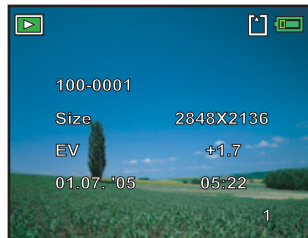







1. Rotate the mode dial to **S**, **P**, **PICT**, **Av**, **Tv**, **M** or **☺** and turn your camera on by pressing the **☺** button.
2. Press the **▶** button.
 - The last recorded image appears on the LCD monitor.
3. Use **◀** or **▶** to select the desired images.
 - To view the previous image, press **◀**.
 - To view the next image, press **▶**.



- The playback information displayed on the LCD monitor will disappear after 2 seconds.
- For protected images/movie clips, **On** mark will be displayed. (Refer to EN-47 for further details.)
- For images selected for printing with DPOF setting, **☺** mark will be displayed. (Refer to EN-48,49 for further details.)
- If there is no image stored in the internal memory or on the memory card. [No Image] message will appear on the monitor.

Magnifying Images

While reviewing your images, you may enlarge a selected portion of an image. This magnification allows you to view fine details. The zoom factor displayed on the screen shows the current magnification ratio.









1. Press the  button.
 - The last recorded image appears on the LCD monitor.
 - To view the previous image, press .
 - To view the next image, press .
2. Adjust the zoom ratio by using the Zoom  /  button.
 - To enlarge the selected image, press the  button.
 - To return to the normal image, press the  button.
 - The magnification factor is displayed on the LCD monitor.
3. To view different portions of the images, press  /  /  /  to adjust the display area.



- The magnification factors range from 1x to 4x (within 7 stages: 1.0x, 1.5x, 2.0x, 2.5x, 3.0x, 3.5x and 4.0x).

Thumbnail Display

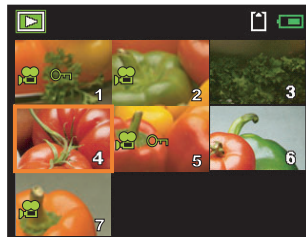

This function allows you to view 9 thumbnail images on the LCD monitor simultaneously so you may search for a particular image.

1. Press the  button.
 - The last recorded image appears on the LCD monitor.
2. Press the  button once.
 - Nine thumbnail images are displayed simultaneously.
 - For recorded movie clips, the  movie mode icon will be displayed.
3. Use  /  /  /  to move the cursor to select the image to be displayed at regular size.
4. Press the  button to display the selected image on full screen.





Slideshow Display

The slide show function enables you to play your images back automatically in sequential order. This is very useful and entertaining feature for reviewing recorded images and for presentations.

1. Press the  button.
 - The last recorded image appears on the LCD monitor.
2. Press the **MENU** button, then use **▼** to select [Slideshow] and press the  button.















3. Use **▲** or **▼** to set the playback interval, then press the  button.
 - The slide show starts.
 - The movie clips are displayed the first frame image, and not played back.
 - To stop slide show, press the  button.



- You can adjust the slide show display interval within the range of 3 sec., 5 sec., 10 sec..

Resizing an Image

You can change the image size of a captured image to one of the following sizes: 2848 x 2136 pixel, 2272 x 1704 pixel, 1600 x 1200 pixel and 640 x 480 pixel.



1. Press the  button.
 - The last recorded image appears on the LCD monitor.
2. In the  mode, use  or  to select the desired images.
 - To view the previous image, press .
 - To view the next image, press .
3. Press the **MENU** button, and press  to select [PlayBack2].
4. Use  or  to select [Resize] and press the  button.
5. Use  or  to select the desired setting, then press the  button to confirm.



MOVIE MODE

Recording Movie Clips

This mode allows you to record movie clips with sound via built-in microphone.



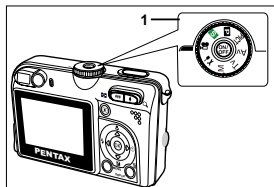



1. Rotate the mode dial to  and turn your camera on by pressing the  button.
2. Press the shutter button to start recording.
3. To stop recording, press the shutter button again.



- The zoom function of optical zoom (3x) can be activated before you start recording the movie clips.
- To enable digital zoom feature, set the [Digital Zoom] to [On] on the movie menu.
- Pressing the **DISPLAY** button switches the LCD monitor display mode. Each time you press the **DISPLAY** button, the display changes in the following order: Focus Frame On → Indicators Off → Composition Line On → LCD Off.

Playing Back Movie Clips

You can play back the recorded movie clips on the LCD monitor. However, the sound recorded with movie clips can only be played back on TV or computers.

1. Press the  button.
2. Use  or  to go through the images until the movie clip you want to play back is displayed.
 - To view the previous image, press .
 - To view the next image, press .
3. Press the  button to start playing back the movie clips.
 - To pause or resume movie playback, press the  button again.

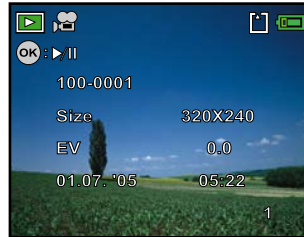

- The playback information displayed on the LCD monitor will disappear after 2 seconds.
- The zoom function cannot be activated for movie clips.
- To playback the movie clips on the computer, we recommend you to use Windows Media Player 9.0 (WMP 9.0). You can download WMP version from the website at www.microsoft.com.

PLAYBACK MODE – ADVANCED FEATURES

Playing Back Still Images/Movie Clips on TV

You can also playback your images on a TV screen. Before connecting to any device, make sure to select NTSC/PAL system to match the video output system of the video equipment you are going to connect to the digital camera, then turn off all devices to be connected.

1. Connect one end of the AV cable to the AV terminal of the digital camera.
2. Connect the other end to the AV input socket of the TV set.
3. Turn the TV and digital camera on.
4. Playback the images/movie clips.
 - The method of operation is the same as playing back still images and movie clips on the digital camera.

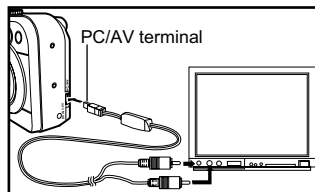

-
- The sound recorded with movie clips can only be played back on TV or computers.

Deleting Images/Movie Clips

Use this function to delete one or all images/movie clips stored in the internal memory or memory card. Please note that the deleted images or movie clips cannot be recovered. Exercise caution before deleting a file.



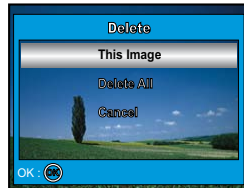













1. Rotate the mode dial to **S**, **P**, PICT, Av, Tv, M or **M** and turn your camera on by pressing the **ON** button.
2. Press the **DEL** button.
 - The last recorded image appears on the LCD monitor.
3. Use **◀** or **▶** to select the image you want to delete.
4. Press the **DEL** button.
5. Use **▲** or **▼** to select [This Image] or [Delete All] by your preference, then press the **OK** button.
6. When the delete message appears, use **▲** or **▼** to select [OK], then press the **OK** button to confirm the deletion.
 - If you wish to cancel the deletion, select [Cancel].



- Protected images cannot be deleted with the delete function.

Protecting Images/Movie Clips

Set the data to read-only to prevent images from being erased by mistake.



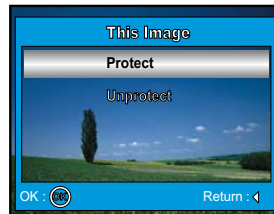
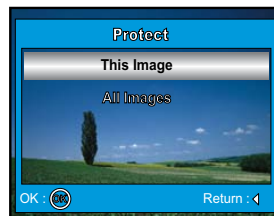







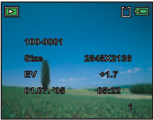

1. Press the  button.
 - The last recorded image appears on the LCD monitor.
2. In the  mode, use  or  to select the desired images.
 - To view the previous image, press .
 - To view the next image, press .
3. Press the **MENU** button.
4. Use  to select [Protect] and press the  button.
5. Use  or  to choose the desired setting, then press the  button.
 - [This Image]: Protect one image/movie.
 - [All Images]: Protect all images/movies (at once).
6. Use  or  to select [Protect], then press the  button to confirm.
 - Press the **MENU** button to return to the  mode.
The  indicator appears on the selected image.
 - If you wish to cancel the protect function, select [Unprotect].









Setting the DPOF

DPOF (Digital Print Order Format) allows you to embed printing information on your memory card. By using DPOF, you can select an image to be printed and then specify how many prints or which image you would like. Take your memory card to a DPOF enabled printer that accepts memory cards. The DPOF/ card-compatible printer will read the embedded information on the memory card and print your images as specified.

■ To configure print settings for a single image / all images.

Step	Figure	Procedure
1		Press the  button, then use  or  to select the desired image you want to mark  . * The playback information displayed on the LCD monitor will disappear after 2 seconds.
2		Press the MENU button. Use  or  to select [DPOF], then press the  button.
3		Use  or  to select by your preference, then press the  button. [Single image]: To configure print settings for a single image. [All Images]: To configure print settings for all images. [Reset All]: Returns all basic settings to the digital camera's default settings.

Step	Figure	Procedure
4		<p>Use ▲ or ▼ to select by your preference, then press the  button.</p> <p>[Copies]: Allows you to select image quantity (0~10). Use ◀ or ▶ to set the image quantity.</p> <p>[Date]: The date of recording can be printed directly on the images. Select [OK] or [Cancel] with ◀ or ▶ .</p> <p>[Return]: To exit the mark function, use ▲ or ▼ to select [Return], then press the  button.</p>
5		<p>Press the MENU button to return to the image playback mode.</p> <p>* The  is marked on the displayed image.</p> <p>To unmark the  mark, go back to step 3 to select [Reset All] with ▲ or ▼.</p>



- Before you perform the DPOF settings on your camera, always remember to copy your images from the internal memory to an SD memory card first.
- The  print icon will appear on the monitor indicating images selected for printing.
- You cannot print movies.

Connecting to a PictBridge-Compatible Printer

Even if you do not have a computer, you can connect the camera directly to a printer that supports PictBridge to perform image selection and printing using the camera monitor screen and controls. DPOF support also lets you specify which images you want to print and how many copies of each should be printed.

Connecting the camera to the printer

1. Rotate the mode dial to **1/X** and turn your camera on by pressing the **ON** button.
2. Press **▶** to select the [Set-up2] menu, then use **▼** to select [USB Con.]. Press the **OK** button.
3. Use **▲** or **▼** to select [PictBridge], then press the **OK** button.
4. Connect your camera and the printer via a supplied USB cable.
 - The screen turns off automatically and the setting screen will appear on the monitor after 2 seconds.



- On Windows 98/98SE/ME/2000, if the camera is connected to your computer and you unintentionally set the camera's USB connection to PictBridge, the "Install Driver" message will appear. Ignore this message and click "Cancel".











Printing images

When the camera is properly connected to a PictBridge-compatible printer, the [Select Printing Mode] screen is displayed on the monitor. Use **▲** or **▼** to select the print mode.



- **In [Print] Mode:** Lets you print the specified image with PictBridge.

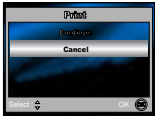

Step	Figure	Procedure
1		Use ▲ or ▼ to select the [Print] mode, then press the OK button.

Step	Figure	Procedure
2		<p>Use ▲ or ▼ to access the paper selection setting, then press the OK button to confirm.</p> <p>[Paper Size]: You may select the desired item depending on the type of printer being used.</p> <p>[Borderless]: You may select the desired item depending on the type of printer being used.</p> <p>[Cancel]: To cancel the setting, use ▲ or ▼ to select [Cancel].</p>
3		<p>Use ◀ or ▶ to select the image you want to print, then press ▼ to set more detailed settings.</p>
4		<p>Use ▲ or ▼ to select by your preference, then press the OK button.</p> <p>[Copies] : Specifies the number of prints. You can select the number up to 10.</p> <p>[Date]: If you select [With], images are printed with the date.</p> <p>[File Name]: If you select [With], images are printed with the file name.</p> <p>[Cancel]: To cancel the print settings, use ▲ or ▼ to select [Cancel].</p>
5		<p>After the step 4 is finished, you can still use ◀ or ▶ to change the image by your preference, then press the OK button to print.</p>

Step	Figure	Procedure
6		Use ▲ or ▼ to select [Print], then press the  button to confirm.
7		This starts printing and displays the message “Printing now” on the monitor screen. The message will disappear after the printing is finished.
		* To cancel printing: Pressing the  button during print data transfer displays the screen for selecting whether to [Continue] or [Cancel] printing.

- **In [Print w/DPOF setting] Mode:** This function only lets you print the specified image based on the previous DPOF settings.

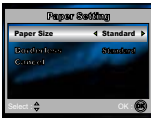
Step	Figure	Procedure
1		Use ▲ or ▼ to select the [Print w/DPOF setting] mode, then press the  button.

Step	Figure	Procedure
2		<p>Use ▲ or ▼ to access the paper selection setting, then press the OK button to print.</p> <p>[Paper Size]: You may select the desired item depending on the type of printer being used.</p> <p>[Borderless]: You may select the desired item depending on the type of printer being used.</p> <p>[Cancel]: To cancel the setting, use ▲ or ▼ to select [Cancel].</p>
3		<p>Use ▲ or ▼ to select [Print], then press the OK button to confirm.</p>
4		<p>This starts printing and displays the message “Printing now” on the monitor screen. The message will disappear after the printing is finished.</p> <p>* To cancel printing: Pressing the OK button during print data transfer displays the screen for selecting whether to [Continue] or [Cancel] printing.</p>

TRANSFERRING FILES FROM YOUR DIGITAL CAMERA TO COMPUTER

After using USB cable to establish a USB connection between the camera and your computer, you can use your computer to share recorded images or movie clips with your family or friends via e-mail or post them on the Web. In order to do this, you must install the USB driver onto your computer first. Note that before you begin to install the software, you need to check your system according to the table as shown below.

	System Requirements (Windows)	System Requirements (Macintosh)
CPU	Pentium III 600 MHz processor or higher	PowerPC G3/G4/G5
Operating System	Windows 98/98SE/ME/2000/XP	OS 9.2 or higher
RAM	32MB (64MB RAM recommended)	32MB (64MB RAM recommended)
Hard Disk Space	128MB hard disk space	128MB hard disk space
Required Devices	A CD-ROM drive An available USB port	A CD-ROM drive An available USB port
Display	Color Monitor (800x600, 24-bit or higher recommended)	Color Monitor (800x600, 24-bit or higher recommended)

Step I: Install the USB driver

■ Installation on Windows 98 & 98SE

The USB driver on the supplied CD-ROM (S-SW38) is exclusively for Windows 98 and 98SE. Windows 2000/ME/XP users don't need to install the USB driver.

1. Insert the enclosed CD-ROM (S-SW38) into your CD-ROM drive.
2. Connect the camera to the PC with the USB cable.
3. The **"Add New Hardware Wizard"** will appear on screen as shown on the right. Click on "Next".

4. Select "Search for the best driver for your device". Click on "Next".

5. Select "CD-ROM drive" and "Specify a location" as shown on the right. Click on "Next".

Follow the on-screen instructions to complete the installation.

6. After the USB driver has been installed, restart your computer.

■ Installation on MAC OS 9.2

For Mac OS 9.2 or higher, the computer will automatically recognize the digital camera and load its own USB drivers.

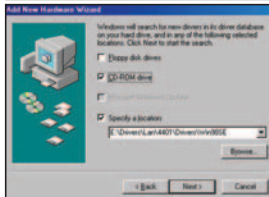
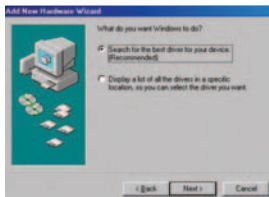
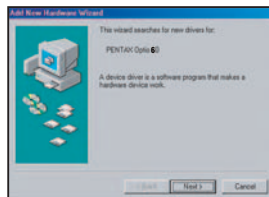

Step 2: Connect the digital camera to your computer

1. Rotate the mode dial to **1/X** and turn your camera on by pressing the **ON** button.
2. Press **▶** to select the [Set-up2] menu, then use **▼** to select [USB Con.].
3. Press the **OK** button.
4. Use **▼** to select [PC], then press the **OK** button.
5. Turn off your camera.
6. Connect your camera and the computer via a supplied USB cable.
7. Turn your camera on by pressing the **ON** button.
8. There will be a new "Removable Disk" icon detected in "My Computer", which contains your recorded images or movie clips. (For Mac users, double-click [untitled] or [unlabeled] disk drive icon on our desktop.)

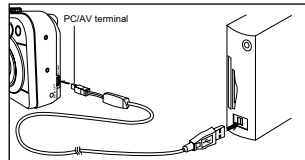

Step 3: Download images or movie clips

When the digital camera is turned on and connected to your computer, it is considered to be a disk drive, just like a floppy disk or CD. You can download (transfer) images by copying them from the “Removable disk” (“untitled” or “unlabeled” disk on a Macintosh) to your computer hard drive.

■ Windows

Open the “removable disk” and double click on the DCIM folder to open it to find more folders. Your images are inside these folder(s). Select the desired still images or movie clips and then choose “Copy” from the “Edit” menu. Open the destination location (folder) and choose “Paste” from the “Edit” menu. You may also drag and drop image files from the digital camera to a desired location.

■ Macintosh

Open the “untitled” disk icon, and the destination location on your hard disk. Drag and drop from the digital camera to the desired destination.



-
- Memory card users may prefer to use a memory card reader (highly recommended).
 - Movie playback application is not included with the package. Make sure that movie playback application has been installed in your computer.

EDITING SOFTWARE INSTALLATION

Installing ACDSee for PENTAX

With ACDSee for PENTAX, you can find, organize, and preview images and media files on your computer, and efficiently acquire images from digital cameras, scanners, and other devices. ACDSee for PENTAX's full-featured image viewer and media player quickly generates high-quality displays of your images and media files.

Also, ACDSee for PENTAX includes a wide variety of image editing tools you can use to create, edit, and touch-up your digital images. Use tools such as red-eye reduction, crop, sharpen, blur, and emboss to enhance or correct your images. Image management tools, such as exposure adjustment, convert, resize, rename, and rotate, can be used to adjust multiple files at the same time.

1. Insert the enclosed CD-ROM (S-SW38) into your CD-ROM drive.
2. When the welcome screen appears, select "**Application Software**".
3. Select the desired language.
Follow the on-screen instructions to complete the installation.



- For more information about the operation of ACDSee for PENTAX application software, refer to its respective help documentation.
- For Windows 2000/XP users, please make sure to install and use the ACDSee for PENTAX in "Administrator" mode.

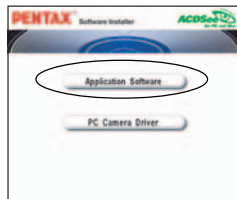

USING THE DIGITAL CAMERA AS A PC CAMERA

Your digital camera can act as a PC camera, which allows you to videoconference, or have a real-time conversation with friends or family. To use the digital camera for videoconferencing, your computer system must include the items as below:

- Microphone
- Sound card
- Speakers or headphones
- Network or Internet connection



- Video conferencing (or video editing) software is not included with the digital camera.
- This mode is not supported for Mac.

Step I: Install the PC camera driver

The PC-camera driver included in the CD-ROM (S-SW38) is exclusively for Windows. The PC camera function is not supported for Mac platforms.

1. Insert the enclosed CD-ROM (S-SW38) into your CD-ROM drive.
2. When the welcome screen appears, select "**PC Camera Driver**".
3. Select the desired language.

Follow the on-screen instructions to complete the installation.

4. After the driver installation is completed, restart your computer.

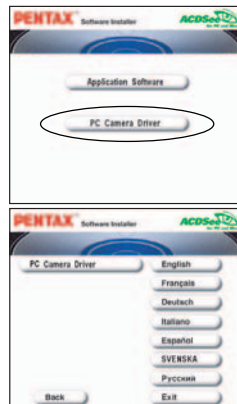

Step 2: Connect the digital camera to your computer

1. Rotate the mode dial to and turn your camera on by pressing the button.
2. Press to select the [Set-up2] menu, then use to select [USB Con.].
3. Press the button.
4. Use or to select [PC Camera], then press the button.
5. Connect your camera and the computer via a supplied USB cable.
6. Position the digital camera steadily on top of your computer monitor or use a tripod.



- When using this digital camera as a PC camera, it is necessary to install the battery into the digital camera.

Step 3: Run your application software (i.e. Windows NetMeeting)

To use Windows NetMeeting for videoconferencing:

1. Go to **Start** → **Programs** → **Accessories** → **Communications** → **NetMeeting** to launch the NetMeeting program.
2. Click the Start Video button to view live video.
3. Click the Place Call button.
4. Type the e-mail address or the network address of the computer that you are calling.
5. Click Call. The person that you are calling must also have Windows NetMeeting running and be willing to accept your call to start the videoconference.



- The video resolution for videoconferencing applications is generally 320 x 240.
- For more information about the operation of videoconference application software, refer to its respective help documentation.

MENU OPTIONS









Camera Menu



This menu is for the basic settings to be used when capturing still images.













1. Rotate the mode dial to **S**, **P**, **PICT**, **Av**, **Tv** or **M** and turn your camera on.
2. Press the **MENU** button, then use **◀** or **▶** to select the [Mode1] / [Mode2] / [Mode3] menu.
 - In **S** Mode, press the **MENU** button to access the [Simple] menu directly.
3. Use **▲** or **▼** to select the option item, then press the **OK** button.
4. Press **▲** or **▼** to select the desired setting, then press the **OK** button.





■ In the **S** Mode















Item	Functional Description
 Recorded pixels	Sets the size of the image that will be captured. (Refer to EN-25 for further details.) <ul style="list-style-type: none">*  2848x2136*  2272x1704*  1600x1200*  640x480
 Quality Level	Sets the quality (compression rate) at which the image is captured. <ul style="list-style-type: none">*  Best*  Better*  Good

Item	Functional Description
Drive Mode 	Sets the recording method at the time of taking pictures. (Refer to EN-35,36 for further details.) * <input type="checkbox"/> Standard *  HS Continuous *  Auto Bracket

■ In the , PICT, Av, Tv or M Mode

Mode1	Item	Functional Description
	Recorded pixels 	Refer to the Camera Menu's option item (the  Mode). (Refer to EN-61 for further details.)
	Quality Level 	Refer to the Camera Menu's option item (the  Mode). (Refer to EN-61 for further details.)
	White Balance 	Sets the white balance when shooting under a variety of lighting conditions and permits photographs to be taken that approach the conditions that are seen by the human eye. (Refer to EN-31 for further details.) * [No icon] Auto *  Daylight *  Cloudy *  Tungsten Light *  Fluorescent Light
	Sensitivity 	Sets the sensitivity for taking pictures. When the sensitivity is raised (and the ISO figure is increased), photography will become possible even in dark locations, but the more pixilated (grainier) the image will appear. *Auto / 64 / 100 / 200







Mode2	Item	Functional Description
	AE Metering 	Refer to the section in this manual titled "Selecting the Metering Mode". (Refer to EN-37 for further details.)
	Drive Mode 	Refer to the Camera Menu's option item (the S Mode). (Refer to EN-35, 36, 61 for further details.)
	Digital Zoom 	This sets whether or not to use digital zoom at the time of shooting. * On / Off
	Instant Review 	Set to display a photographed image on LCD monitor immediately after you have taken the shot. * On / Off

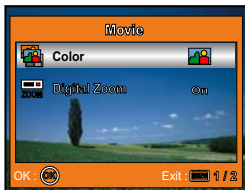



Mode3	Item	Functional Description
	Color 	Sets the color of the image that will be captured. *  Full Color *  B&W *  Sepia
	Sharpness 	Sets the level of image sharpness. *  High *  Medium *  Low
	Saturation 	To capture an image, your camera offers you three different degrees of color to match with your preference. Your images will demonstrate different impression by selecting different degrees of color. This is called "Saturation". *  High *  Medium *  Low
	Date Imprint 	The date of recording can be printed directly on the still images. This function must be activated before the image is captured. The date appears on the right bottom of the captured picture. When images are shot with date imprint feature, the date cannot be removed later. * On / Off 

Movie Menu

This menu is for the basic settings to be used when recording movie clips.











1. Rotate the mode dial to  and turn your camera on.
2. Press the **MENU** button.
3. Use  or  to select the option item, then press the  button.
4. Use  or  to select the desired setting, and press the  button.
5. To exit the movie menu, press the **MENU** button.

Item	Functional Description
 Color	Refer to the Camera Menu's option item (the  , PICT , Av , Tv or M Mode). (Refer to EN-64 for further details.)
 Digital Zoom	Refer to the Camera Menu's option item (the  , PICT , Av , Tv or M Mode). (Refer to EN-63 for further details.)



Playback Menu

In the  menu, set which settings are to be used for playback.













1. Press the  button.
 - The last recorded image appears on the LCD monitor.
2. Press the **MENU** button, then use  or  to select the [PlayBack1] / [PlayBack2] menu.
3. Use  or  to select the option item, then press the  button.
4. Use  or  to select the desired setting, and press the  button.
5. To exit the playback menu, press the **MENU** button.

■ [PlayBack1] settings

Item	Functional Description
 Slideshow	You can play back recorded images in order with a selected interval time. This function is useful for checking your images or for presentations, etc. Refer to the section in this manual titled "Slideshow Display". (Refer to EN-41 for further details.) * 3 sec. / 5 sec. / 10 sec.
 Protect	Set the data to read-only to prevent images from being erased by mistake. Refer to the section in this manual titled "Protecting Images/Movie clips". (Refer to EN-47 for further details.)
 DPOF	Allows you to select the desired pictures to be printed and set the number of prints and date displayed in DPOF format. You can print images easily just by inserting the memory card to a DPOF-compatible printer or taking it to a print shop. Refer to the section in this manual titled "Setting the DPOF". (Refer to EN-48 for further details.)

■ [PlayBack2] settings

Item	Functional Description
Resize 	<p>Changes the size of a recorded image. Resizing replaces the original image with the changed image. Only resizing to the smaller size is available. (Refer to EN-42 for further details.)</p> <ul style="list-style-type: none"> *  2848x2136 *  2272x1704 *  1600x1200 *  640x480
Quality Change 	<p>Change the quality (compression rate) of a recorded image. Compresses images down to half of their size or more, overwrites an old size images with a newly compressed image. Only quality changing to the lower quality level is available.</p> <ul style="list-style-type: none"> *  Best *  Better *  Good
Image Copy 	<p>Allows you to copy your files from the digital camera's internal memory to a memory card. Of course, you can only do this if you have a memory card installed and some files in internal memory.</p> <p>* OK / Cancel</p>





Setup Menu

This feature allows you to set up the default settings by preference for using your camera.







1. Rotate the mode dial to M mode and turn your camera on.
2. Press \leftarrow or \rightarrow to select the [Set-up1] / [Set-up2] / [Set-up3] menu.
3. Use \blacktriangle or \blacktriangledown to select the option item, then press the OK button.
4. Use \blacktriangle or \blacktriangledown to select the desired setting, and press the OK button.
5. To exit the setup menu, rotate the mode dial to another mode.



■ [Set-up1] settings

Item	Functional Description
Format 	Erases all images and reformats the SD card loaded in your camera. Protected images are also erased. SD card cannot be formatted if it is write-protected. Refer to the section in this manual titled “Formatting an SD Memory Card or Internal Memory”. (Refer to EN-22 for further details.) * OK / Cancel
Sound 	This sets whether or not to mute the startup sound, and the camera sound each time you press a camera button. * Loud / Soft / Off
Date Adjust 	This sets the date and the time. Refer to the section in this manual titled “Setting the Date and Time”. (Refer to EN-21 for further details.) * y/m/d * d/m/y * m/d/y
Language 	Sets the language that is displayed on the LCD monitor. Refer to the section in this manual titled “Choosing the Screen Language”. (Refer to EN-20 for further details.) * English / Français / Deutsch / Español / Italiano / Svenska / Nederlands / Русский

■ [Set-up2] settings

Item	Functional Description
USB Connection 	Selects to choose one of the following modes for further settings. (Refer to EN-50, 56, 60 for further details.) * PC / PictBridge / PC Camera
Video Out 	Sets video output of the camera for matching the video output system of the equipment that you are going to connect to the camera. * PAL / NTSC
Brightness 	This sets the brightness of the LCD monitor. The adjustment range is from -5 to +5.
Auto Power Off 	If no operation is performed for a specific period of time, the power to the camera is automatically turned off. This feature is useful to reduce battery wear. * 2 min. / 3 min. / 5 min. / Off

■ [Set-up3] settings

Item	Functional Description
Reset No. 	Sets whether or not to reset the file number when you take photographs. This creates a new folder. The captured images are recorded to the newly created folder from number 0001. If you want to reset the file number, be sure that no images are recorded in the internal memory or the SD memory card. * OK / Cancel
Reset 	Returns all basic settings to the digital camera's default settings. The time setting will not be reset. * OK / Cancel
Version 	This displays the current firmware version of the camera.

CONNECTING THE DIGITAL CAMERA TO OTHER DEVICES

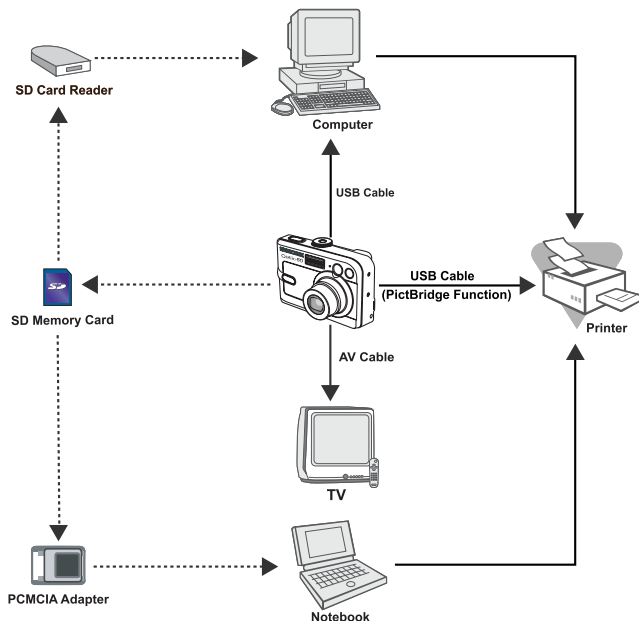

SPECIFICATIONS







Item	Description
Image Sensor	CCD
Effective pixels	6.0 Mega pixels
Image size	Still image: 2848 x 2136, 2272 x 1704, 1600 x 1200, 640 x 480 Movie clip: 320 x 240
Image quality	Still image: Best, Better, Good Movie image: Good
Recording media	Approx. 12MB internal memory SD memory card (Optional, up to 1GB)
File format	Motion JPEG (AVI); PictBridge support; PC-CAM support (QVGA around 24 f/s)
Lens	F-no.: Wide: 2.8 / Tele: 4.8 Focal length: 7.5mm-22.5mm (Equivalent to 35mm Camera: 36~108 mm)
Focus range	Normal : 0.5 m to infinity Macro : 0.05 m to infinity (Wide) : 0.3 m to infinity (Tele)
Flash effective range	Wide: Approx. 0.5 m - Approx. 3.8 m (at the standard output sensitivity of 200) Tele: Approx. 0.5 m - Approx. 2.0 m (at the standard output sensitivity of 200)
LCD monitor	2.0" TLT color LCD High-resolution 130K pixels display
Self-timer	10 sec delay, 2 sec delay, 10+2 sec delay
Exposure compensation	-2.0EV~ +2.0EV (in 0.3EV increments)
White balance	Auto, Daylight, Cloudy, Tungsten, Fluorescent
ISO	Auto, 64, 100, 200
Interface	DC-IN jack, USB/AV terminal
Power	2 x AA (alkaline or Ni-MH rechargeable) batteries (Two alkaline batteries allow approximately 80 shots to be taken*) (Two Ni-MH rechargeable batteries (2500mAh) allow approximately 270 shots to be taken*) AC-DC Adapter (3V/2.5A) (Optional)
Dimension	Approx. 91 x 61 x 38 mm
Weight	Approx. 150g (without batteries and the SD memory card)

* Recording capacity shows approximate number of shots recorded during CIPA-compliant testing. Actual performance may vary according to operating conditions.

- Design and specifications are subject to change without notice.





APPENDIX

■ Troubleshooting Guide

Symptom	Possible causes	Solutions / Corrective Actions
Power does not turn on.	<ul style="list-style-type: none"> * The battery has run out. * The battery is not oriented correctly. * The battery cover is not closed properly. * The AC power adapter (optional) is disconnected. 	<ul style="list-style-type: none"> * Load new or fully charged battery. * Load the battery in the correct direction. * Close the battery cover correctly. * Properly connect the AC power adapter.
Camera suddenly powers down.	<ul style="list-style-type: none"> * The function of [Auto Off] in the  mode has been activated. * The battery has run out. 	<ul style="list-style-type: none"> * Turn the power back on and set the option of [Auto Off] to [Off]. * Load new or fully charged battery.
Image is not captured when the shutter button is pressed.	<ul style="list-style-type: none"> * The camera is in the  or  mode. * Memory is full. 	<ul style="list-style-type: none"> * Rotate the mode dial to , , PICT, Av, Tv or M. * Transfer the desired files to your computer and then delete unnecessary files, or use a different memory card.
Flash does not fire.	<ul style="list-style-type: none"> * Flash off is selected in flash mode. * The [Drive Mode] is set to [HS Continuous] or [Auto Bracket]. * The camera is in the  (movie) mode. 	<ul style="list-style-type: none"> * Select a different flash mode. * Select [Standard] in the [Drive Mode]. * Switch the mode dial to another mode.
Continuous shooting is not possible.	<ul style="list-style-type: none"> * The capacity of the built-in memory or SD memory card is full. 	<ul style="list-style-type: none"> * Insert a new SD memory card.
Cannot transfer files over a USB connection.	<ul style="list-style-type: none"> * USB cable is not connected securely. * USB driver is not installed. * Camera is turned off. 	<ul style="list-style-type: none"> * Check all connections. * Install the USB driver on your computer. * Turn on the camera.

■ Possible Number of Recordable Images

The frame counter indicates the approximate number of images that can be stored on the internal memory and the SD memory card. The number of recordable images may vary depending on the recorded subject, the capacity of the memory card, if there are files other than images or when the recording is made while switching the picture quality or resolution.

Resolution	Quality (Compression Ratio)	Internal Memory	SD Memory Card					
			32MB	64MB	128MB	256MB	512MB	1GB
2848 x 2136 	** Best (1/4)	3	8	18	36	73	148	285
	* Better (1/8)	7	17	36	73	147	296	570
	★ Good (1/16)	14	35	73	147	294	593	1140
2272 x 1704 	** Best (1/4)	5	13	28	57	114	231	444
	* Better(1/8)	11	27	56	115	229	462	889
	★ Good (1/16)	22	55	113	230	458	924	1778
1600 x 1200 	** Best (1/4)	10	26	54	110	219	442	851
	* Better (1/8)	21	53	107	217	433	873	1679
	★ Good (1/16)	42	106	215	435	866	1724	3358
640 x 480 	** Best (1/4)	63	166	322	652	1300	2620	5038
	* Better (1/8)	127	333	645	1305	2600	5240	10076
	★ Good (1/16)	254	667	1291	2610	5201	10480	20152

- The above data shows the standard testing results. The actual capacity varies according to the shooting conditions and settings.

■ Approximate Duration of Recording Time

The table below indicates the approximate duration of recording time depending on the capacity of the internal memory and the SD memory card.

Image size	Internal Memory	SD Memory Card					
		32MB	64MB	128MB	256MB	512MB	1GB
320 x 240	00:55	02:19	04:47	09:42	19:20	39:00	1:15:01

■ The values for the recording time may vary depending on the shooting conditions and settings.

WARRANTY POLICY

All PENTAX cameras purchased through authorized bona fide photographic distribution channels are guaranteed against defects of material or workmanship for a period of twelve months from date of purchase. Service will be rendered, and defective parts will be replaced without cost to you within that period, provided the equipment does not show evidence of impact, sand or liquid damage, mishandling, tampering, battery or chemical corrosion, operation contrary to operating instructions, or modification by an unauthorized repair shop. The manufacturer or its authorized representatives shall not be liable for any repair or alterations except those made with its written consent and shall not be liable for damages from delay or loss of use or from other indirect or consequential damages of any kind, whether caused by defective material or workmanship or otherwise; and it is expressly agreed that the liability of the manufacturer or its representatives under all guarantees or warranties, whether expressed or implied, is strictly limited to the replacement of parts as hereinbefore provided. No refunds will be made on repairs by non-authorized PENTAX service facilities.

Procedure during 12-month Warranty Period

Any PENTAX which proves defective during the 12-month warranty period should be returned to the dealer from whom you purchased the equipment or to the manufacturer. If there is no representative of the manufacturer in your country, send the equipment to the manufacturer, with postage prepaid. In this case, it will take a considerable length of time before the equipment can be returned to you owing to the complicated customs procedures required. If the equipment is covered by warranty, repairs will be made and parts replaced free of charge, and the equipment will be returned to you upon completion of servicing. If the equipment is not covered by warranty, regular charges of the manufacturer or of its representatives will apply. Shipping charges are to be borne by the owner.

If your PENTAX was purchased outside of the country where you wish to have it serviced during the warranty period, regular handling and servicing fees may be charged by the manufacturer's representatives in that country. Notwithstanding this, your PENTAX returned to the manufacturer will be serviced free of charge according to this procedure and warranty policy. In any case, however, shipping charges and customs clearance fees to be borne by the sender. To prove the date of your purchase when required, please keep the receipt or bills covering the purchase of your equipment for at least a year. Before sending your equipment for servicing, please make sure that you are sending it to the manufacturer's authorized representatives or their approved repair shops, unless you are sending it directly to the manufacturer. Always obtain a quotation for the service charge, and only after you accept the quoted service charge, instruct the service station to proceed with the servicing.

- * **This warranty policy does not affect the customer's statutory rights.**
- * **The local warranty policies available from PENTAX distributors in some countries can supersede this warranty policy. Therefore, we recommend that you review the warranty card supplied with your product at the time of purchase, or contact the PENTAX distributor in your country for more information and to receive a copy of the warranty policy.**



The CE Mark is a Directive conformity mark of the European Union.

Declaration of Conformity
According to 47CFR, Parts 2 and 15 for
Class B Personal Computers and Peripherals

We: PENTAX IMAGING COMPANY
A Division of PENTAX of America, Inc.
Located at: 600 12 Street, Suite 300
Golden, Colorado 80401 U.S.A.
Phone: 303-799-8000 FAX: 303-790-1131

Declare under sole responsibility that the product identified herein, complies with 47CFR Parts 2 and 15 of the FCC rules as a Class B digital device. Each product marketed is identical to the representative unit tested and found to be compliant with the standards.

Records maintained continue to reflect the equipment being produced can be expected to be within the variation accepted, due to quantity production and testing on the statistical basis as required by 47CFR §2.909. Operation is subject to the following two conditions: (1) This device may not cause harmful interference, and (2) This device must accept any interference received, including interference that may cause undesired operation. The above named party is responsible for ensuring that the equipment complies with the standards of 47CFR §15.101 to §15.109.

Product Name: PENTAX Digital Still Camera
Model Number: Optio 60
Contact person: Customer Service Manager
Date and Place: July, 2005, Colorado

An information on Disposal for users



1. In the European Union

If your product is marked with this symbol, it means that used electrical/electronic products should not be mixed with general household waste. There exists a separate collection system for these products.

Used electric/electronic equipment must be treated separately and in accordance with legislation that requires proper treatment, recovery and recycling of these products. Following the implementation by member states, private households within the EU states may return their used electrical/electronic equipments to designated collection facilities free of charge*. In some countries your local retailer may also take back your old product free of charge if you purchase a similar new one.

*Please contact your local authority for further details.

By disposing of this product correctly you will help ensure that the waste undergoes the necessary treatment, recovery and recycling and thus prevent potential negative effects on the environment and human health which could otherwise arise due to inappropriate waste handling.

2. In other countries outside the EU

If you wish to discard this product, please contact your local authorities and ask for the correct method of disposal.

For Switzerland: Used electrical/electronic equipment can be returned free of charge to the dealer, even when you don't purchase a new product. Further collection facilities are listed on the home page of www.swico.ch or www.sens.ch.