

PENTAX



Digital Camera

Optio M50

Operating Manual

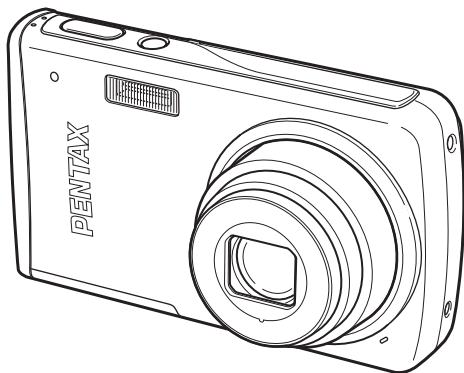

To ensure the best performance from your camera, please read the Operating Manual before using the camera.

Thank you for purchasing this PENTAX Digital Camera. Please read this manual before using the camera in order to get the most out of all the features and functions. Keep this manual safe, as it can be a valuable tool in helping you to understand all the camera capabilities.

Regarding copyrights

Images taken using the PENTAX Digital Camera that are for anything other than personal enjoyment cannot be used without permission according to the rights as specified in the Copyright Act. Please take care, as there are cases where limitations are placed on taking pictures even for personal enjoyment during demonstrations, performances or of items on display. Images taken with the purpose of obtaining copyrights also cannot be used outside the scope of use of the copyright as laid out in the Copyright Act, and care should be taken here also.

To users of this camera

- There is a possibility that recorded data may be erased or that the camera may not function correctly when used in surroundings such as installations generating strong electromagnetic radiation or magnetic fields.
- The liquid crystal panel used in the display is manufactured using extremely high precision technology. Although the level of functioning pixels is 99.99% or better, you should be aware that 0.01% or fewer of the pixels may not illuminate or may illuminate when they should not. However, this has no effect on the recorded image.
- There is a possibility that the illustrations and the display screen of the display in this manual are different from the actual product.
- In this manual, both an SD Memory Card and an SDHC Memory Card are referred to as SD Memory Cards hereafter.

Regarding trademarks

- PENTAX and Optio are trademarks of PENTAX Corporation.
- SDHC logo () is trademark.
- This product supports PRINT Image Matching III. PRINT Image Matching enabled digital still cameras, printers and software help photographers to produce images more faithful to their intentions. Some functions are not available on printers that are not PRINT Image Matching III compliant. Copyright 2001 Seiko Epson Corporation. All Rights Reserved. PRINT Image Matching is a trademark of Seiko Epson Corporation. The PRINT Image Matching logo is a trademark of Seiko Epson Corporation.
- All other brands or product names are trademarks or registered trademarks of their respective companies.

Regarding PictBridge

PictBridge allows the user to connect the printer and digital camera directly, using the unified standard for the direct printout of images. You can print images directly from the camera through a few simple operations.

Regarding Product Registration

In order to serve you better, we request that you complete the product registration, which can be found on the CD-ROM supplied with the camera or the PENTAX website. Thank you for your cooperation.
Refer to the PC Connection Manual (bottom right of the front side) for more information.

USING YOUR CAMERA SAFELY

We have paid close attention to the safety of this product. When using this product, we request your special attention regarding items marked with the following symbols.



Warning

This symbol indicates that violating this item could cause serious personal injuries.



Caution

This symbol indicates that violating this item could cause minor or medium personal injuries, or material losses.

About the Camera



Warning

- Do not attempt to take the camera apart or remodel the camera. High voltages are present within the camera, and there is therefore a danger of electric shocks if the camera is taken apart.
- If the inside of the camera should become exposed as a result of, for example, the camera being dropped, please do not under any circumstances touch such exposed portions, as there is a danger of receiving an electric shock.
- To avoid the risk of it being swallowed by mistake, keep the SD Memory Card out of the reach of small children. Seek medical attention immediately if a card is accidentally swallowed.
- Wrapping the strap of the camera around your neck is also dangerous. Please take care that small children do not hang the strap around their necks.
- Use an AC adapter that is of the power and voltage specified for exclusive use with this product. The use of an AC adapter other than that specified exclusively for use with this product may cause fire or electric shocks.
- If the camera emits smoke or a strange smell, or in the event of any other irregularity, stop using the camera immediately, remove the battery and contact your nearest PENTAX Service Center. Continued use of the camera may result in fire or electric shock.

Caution

- Do not charge any batteries other than rechargeable lithium-ion battery D-LI78. The battery could explode or catch fire.
- Do not place your finger on the flash when it is discharging as there is a risk of burns.
- Do not discharge the flash while it is touching your clothing as there is a risk of discoloring.
- If any leakage from the battery should come in contact with your eyes, it may cause a loss of sight. Flush your eyes with clean water and get medical attention immediately. Do not rub them.
- If any leakage from the battery should come in contact with skin or clothes, it may cause irritation to the skin. Wash the affected areas thoroughly with water.
- Precautions for D-LI78 Battery Usage:
 - USE SPECIFIED CHARGER ONLY.
 - DO NOT INCINERATE.
 - DO NOT DISASSEMBLE.
 - DO NOT SHORT CIRCUIT.
 - DO NOT EXPOSE TO HIGH TEMP. (140°F / 60°C)
- Remove the battery from the camera immediately if it becomes hot or begins to smoke. Be careful not to burn yourself during removal.
- Some portions of the camera heat up during use, so please take care, as there is a risk of low temperature burns if such portions are held for long periods of time.
- Should the LCD be damaged, be careful of glass fragments. Also, be careful not to allow the liquid crystal to get on your skin or in your eyes or in your mouth.
- Depending on your inherent factors or physical condition, the use of the camera may cause itching, rashes or blisters. In case of any abnormality, stop using the camera and get medical attention immediately.

About the Battery Charger and the AC Adapter

Warning

- Do not use the product at a voltage other than the specified voltage. Use with a power source or voltage other than that designed can cause a fire or electrical shock. The specified voltage is 100-240V AC.
- Do not disassemble or modify the product. This can cause a fire or electrical shock.

- If the generation of smoke or strange odor from the product or other abnormality occurs, immediately discontinue using and consult a PENTAX Service Center. Continuing to use the product can cause a fire or electrical shock.
- If water should happen to get inside the product, consult a PENTAX Service Center. Continuing to use the product can cause a fire or electrical shock.
- If thunder storm should be present during use of the battery charger or AC adapter, unplug the power cord and discontinue use. Continuing to use the product can cause damage to the equipment, fire or electrical shock.
- Wipe off the plug of the power cord if it should become covered with dust. This can cause a fire.

 **Caution**



- Do not place heavy objects on the AC plug cord, allow heavy objects to drop onto it or allow the AC plug cord to become damaged due to excessive bending. If the AC plug cord becomes damaged, consult a PENTAX Service Center.
- Do not short or touch the output terminals of the product while it is still plugged in.
- Do not plug in the AC plug cord with wet hands. This can cause an electrical shock.
- Do not subject the product to strong impacts or allow it to drop onto a hard surface. This can cause a malfunction.
- Do not use the battery charger to charge batteries other than rechargeable lithium-ion battery D-LI78. This can cause overheating or malfunctions.
- To reduce the risk of hazards, use only CSA/UL Certified power supply cord set, cord is Type SPT-2 or heavier, minimum NO.18 AWG copper, one end with a molded-on male attachment plug cap (with a specified NEMA configuration), and the other is provided with a molded-on female connector body (with a specified IEC nonindustrial type configuration) or the equivalent.

Care to be Taken During Handling



- When traveling, take the Worldwide Service Network listing that is included in the package. This will be useful if you experience problems abroad.
- When the camera has not been used for a long time, confirm that it is still working properly, particularly prior to taking important pictures (such as at a wedding or during traveling). Contents of the recording cannot be guaranteed if recording, playback or transferring your data to a computer, etc. is not possible due to a malfunction of your camera or recording media (SD Memory Card), etc.
- The lens on this camera is not interchangeable. The lens is not removable.
- Do not clean the product with organic solvents such as thinner, alcohol or benzene.
- Places of high temperature and humidity should be avoided. Particular care should be taken regarding vehicles, which can become very hot inside.
- This camera is not waterproof. Do not use this camera where it might come in contact with rain, water, or any other liquid.
- Storing the camera where pesticides and chemicals are handled should be avoided. Remove the camera from its case and store in a well-ventilated place to prevent the camera from becoming moldy during storage.
- Ensure that the camera is not subjected to substantial vibrations, shocks or pressure as this may cause damage or malfunction. Place the camera on a cushion for protection when the camera is subjected to the vibrations of a motorbike, car, ship, etc. If the camera is subjected to substantial vibrations, shocks or pressure, take your camera to your nearest PENTAX Service Center and have it checked.
- The temperature range in which the camera can be used is 0°C to 40°C (32°F to 104°F).
- The liquid crystal display will become black at a high temperature but will return to normal when normal temperatures are returned to.
- The response speed of the liquid crystal display becomes slow at low temperatures. This is due to the properties of the liquid crystal and is not a fault.
- Periodic checks are recommended every 1 to 2 years in order to maintain high performance.

- If the camera is subjected to rapid temperature changes, condensation may form on the inside and outside of the camera. Therefore put the camera in a bag or plastic bag, and take the camera out when the difference in temperature has subsided.
- Refer to “Precautions When Using an SD Memory Card” (p.30) regarding the SD Memory Card.
- Please note that formatting an SD Memory Card or built-in memory will delete all data; however it may still be possible to recover that data using off-the-shelf data recovery software. Please manage your camera memory at your own risk.
- Please do not press forcefully on the display. This could cause breakage or malfunction.
- Be careful not to sit down with the camera in your back pocket as this may damage the exterior of the camera or the display.
- When using a tripod with the camera, be careful not to overtighten the screw in the tripod socket on the camera.
- The AC plug cord supplied with the camera is for exclusive use with the battery charger D-BC78. Do not use it with any other equipment.
- Storing the battery fully charged may decrease the battery performance. Avoid storing it especially in high temperatures.
If the battery is left inserted and the camera is not used for a long time, the battery will over-discharge and shorten the battery’s service life.
- Charging the battery a day before use or on the day of use is recommended.

Contents

USING YOUR CAMERA SAFELY	1
Care to be Taken During Handling	4
Contents	6
Composition of the Operating Manual	11
Camera Features	12
Checking the Contents of the Package	15
Names of Parts	16
Names of Operating Parts	17
Monitor Indications	18
Getting Started	21
Attaching the Strap	21
Powering the Camera	22
Charging the Battery	22
Installing the Battery	23
Using the AC Adapter	26
Installing the SD Memory Card	28
Recorded Pixels and Quality Level of Still Pictures	31
Recorded Pixels, Quality Level and Frame Rate of Movies	32
Turning the Camera On and Off	34
Playback Mode	35
Initial Settings	36
Setting the Display Language	36
Setting the Date and Time	38
Quick Start	40
Taking Still Pictures	40
Playing Back Still Pictures	42
Playing Back Images	42
Playing Back the Previous or Next Image	42
Rotating the Displayed Image	43
Common Operations	44
Understanding the Button Functions	44
 Mode	44
 Mode	46
Setting the Camera Functions	48
Setting with the Menus	48
Menu List	51
Setting the Shooting Mode	53

Setting the Face Recognition function.....	56
Calling Up a Specific Menu	57
Using the Playback Function	59
Taking Pictures	61
Taking Pictures	61
Taking Pictures Automatically (Auto Picture Mode)	61
Setting The Functions (Program Mode)	62
Taking Pictures in the Basic Mode (Green Mode).....	63
Taking Pictures of Dark Scenes (Night Scene/Digital SR (Blur Reduction) Mode).....	65
Framing Your Pictures (Frame Composite).....	66
Taking Pictures of People (Natural Skin Tone/Portrait Mode).....	68
Taking Pictures of Your Pet (Pet Mode).....	70
Taking Pictures of Children (Kids Mode).....	72
Taking Panoramic Pictures (Digital Panorama Mode).....	74
Using the Self-timer	76
Taking a Series of Pictures (Continuous Shooting Mode).....	77
Using the Zoom	78
Using the Digital Wide Function (Digital Wide Mode).....	81
Setting the Exposure (EV Compensation).....	84
Displaying Shooting Information in Capture Mode	85
Setting the Shooting Functions	87
Selecting the Focus Mode	87
Selecting the Flash Mode	89
Selecting the Recorded Pixels.....	91
Selecting the Quality Level	93
Adjusting the White Balance.....	94
Setting the AE Metering.....	96
Setting the Sensitivity	98
Setting the Autofocus Conditions	100
Setting the Instant Review Time (Instant Review).....	101
Setting the Image Sharpness (Sharpness).....	102
Setting the Color Saturation (Saturation).....	103
Setting the Image Contrast (Contrast).....	104
Setting the Date Imprint Function	105
Saving the Settings (Memory)	106
Recording Movies	108
Recording a Movie.....	108
Selecting the Recorded Pixels for Movies	110
Selecting the Quality Level of Movies.....	111
Selecting the Frame Rate.....	112
Recording Movies in Black and White or Sepia Tones (Color Mode).....	113

Setting the Movie SR (Movie Shake Reduction) Function.....	114
Playing Back and Deleting Images	115
<hr/>	
Playing Back Images	115
Switching Between  Mode and  Mode.....	115
Playing Back Still Pictures	115
Nine-Image Display, Folder Display and Calendar Display.....	116
Zoom Playback.....	118
Zoom Up On the Subject's Face Automatically (Face close-up playback)	119
Displaying Shooting Information in Playback Mode	121
Correcting Camera Shake with Digital SR.....	122
Slideshow	123
Playing Back Movies	125
Playing Back a Movie	125
Connecting the Camera to AV Equipment	126
Deleting Images	128
Deleting a Single Image/Sound File	128
Deleting Selected Images and Sound Files (from Nine-Image Display).....	130
Deleting All Images and Sound Files.....	132
Recovering Deleted Images	133
Protecting Images and Sound Files from Deletion (Protect)	134
Editing and Printing Images	136
<hr/>	
Editing Images	136
Changing the Image Size and Quality (Resize).....	136
Cropping Images	138
Copying Images and Sound Files.....	139
Using the Digital Filters.....	141
Red-eye Compensation	144
Adding a Frame (Frame Composite).....	145
Editing Movies	147
Setting the Printing Service (DPOF)	149
Printing Single Images.....	149
Printing All Images.....	151
Printing Using PictBridge	152
Connecting the Camera to the Printer	152
Printing Single Images.....	153
Printing All Images.....	155
Printing Using the DPOF Settings	156
Disconnecting the Cable from the Printer	156

Recording Sound (Voice Recording Mode)	157
Playing Back Sound	159
Adding a Voice Memo to Images	160
Recording a Voice Memo	160
Playing Back a Voice Memo.....	161
Settings	162
<hr/>	
Camera Settings	162
Formatting an SD Memory Card or the Built-in Memory	162
Changing the Sound Settings.....	163
Changing the Date and Time.....	165
Setting the World Time	167
Changing the Display Language	169
Changing the Image Folder Name	170
Changing the USB Connection Mode.....	171
Changing the Video Output Format.....	172
Adjusting the Brightness of the Display	173
Using the Power Saving Function	174
Setting Auto Power Off	175
Setting the Quick Zoom Function	176
Setting the Guide Display	177
Resetting to Default Settings (Reset).....	178
Changing the Start-up Screen	179
Appendix	180
<hr/>	
List of World Time Cities	180
Default Settings	181
Functions Available for Each Shooting Mode	186
Optional Accessories	188
Messages	189
Troubleshooting	192
Main Specifications	194
WARRANTY POLICY	198
Index	204

In this manual, the method for operating the four-way controller is shown in illustrations, such as in the one below.

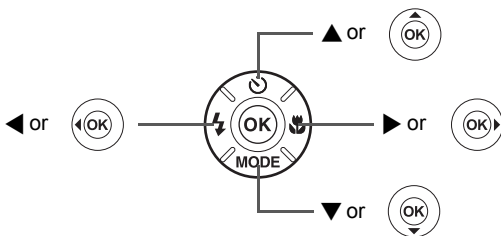

The meanings of the symbols used in this Operating Manual are explained below.

	indicates the reference page number for an explanation of the related operation.
	indicates information that is useful to know.
	indicates precautions to be taken when operating the camera.
mode	This is the mode for capturing still pictures and recording movies and sound files. In this manual, the mode for taking still pictures is referred to as the “Still Picture Capture Mode”, the mode for recording movies is referred to as the “ mode” and the mode for recording sound files is referred to as the “ mode”.
mode	This is the mode for viewing still pictures and playing back movies and sound files.

Composition of the Operating Manual

This Operating Manual contains the following chapters.

1 Getting Started

This chapter explains what you need to do after purchasing the camera before you start taking pictures. Be sure to read it and follow the instructions.

2 Quick Start

This chapter explains the simplest way to take pictures and play back images. Use it if you want to start taking pictures or playing back images straightaway.

3 Common Operations

This chapter explains common operations such as the functions of the buttons and how to use the menus. For more details, refer to the respective chapters below.

4 Taking Pictures

This chapter explains the various ways of capturing images and how to set the relevant functions.

5 Playing Back and Deleting Images

This chapter explains how to view still pictures and movies on the camera or on a TV and how to delete images from the camera.

6 Editing and Printing Images

This chapter explains the various ways of printing still pictures and how to edit images with the camera. For information on transferring images to a PC and installing the provided software, see the supplied "PC Connection Manual". For details on editing and printing images on a PC, see the Help section of the software.

7 Recording and Playing Back Sound

This chapter explains how to record sound files or add sound (a voice memo) to an image, and how to play back sound files.

8 Settings

This chapter explains how to set the camera-related functions.

9 Appendix

This section deals with troubleshooting and lists the optional accessories.

1

2

3

4

5

6

7

8

9

Camera Features

In addition to basic picture-taking, the Optio M50 has a variety of shooting modes to suit different situations. This section describes how to make the most of the key features of your camera. Together with the explanations of camera operations, it will enable you to enjoy your camera to the full.

Advanced Movie Recording and Picture Taking Functions

The Optio M50 has a shake reduction function to reduce camera shake during movie recording. (p.114)

- **For recording the action of sporting events as a movie while capturing the winning shot in a picture.**

Add Fun Frames to Your Pictures!

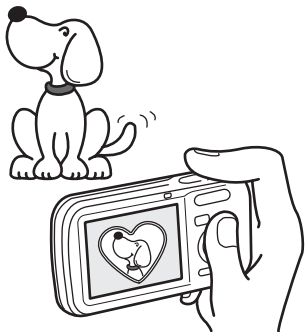

With the Optio M50, you can add a fun frame when taking a picture of a child or a pet, for example. (p.66) You can also add frames to pictures you have taken. Adjust the position of the subject in the picture or reduce or enlarge the picture size to match the frame shape and size. Now you no longer have to worry about the subject not being aligned in the frame. (p.145)

- **For decorating your pictures with a frame.**

Easy-to-Navigate Capture and Playback Functions!

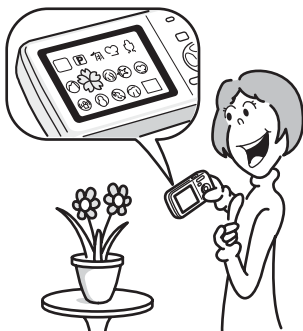

The user-friendly design of the Optio M50 enables easy operation with only a few buttons. Simply by choosing the appropriate icon, you can select the shooting mode (p.53) and choose the optimal settings for the situation, or the playback mode (p.115, p.136) and enjoy the various playback and editing functions. A guide on the display lets you check the functions available in each mode and how to use them. (p.53, p.59)

- **A shooting mode guide is displayed in the Capture Mode Palette and a playback mode guide in the Playback Mode Palette for a few seconds after each mode is selected. (p.53, p.59)**
- **Use the Green Mode to take pictures easily using standard settings. (p.63)**

Display Images and Sound Files in Calendar Format!

With the Optio M50, you can display recorded images and sound files by date in calendar format. (p.117) This lets you quickly find the image or sound file you want to play back.

Enjoy Playback and Editing Functions Without a Computer!

The Optio M50 lets you play back and edit images without having to connect the camera to your computer and transfer the images first. The camera is all you need to take and edit still pictures and movies. (p.136) And no more worries about accidentally deleting images, because now, with the Optio M50, you can recover them again. (p.133)

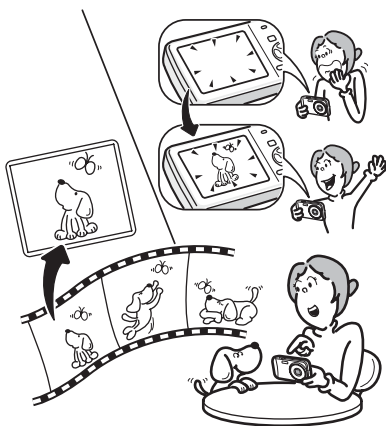

- **Resize (p.136) , Cropping (p.138) , and Red-eye Compensation (p.144) can be used, while the image is displayed in Playback mode.**
- **You can divide a movie into two or select a frame from a movie to save it as a still picture. (p.147)**

Checking the Contents of the Package



Camera
Optio M50

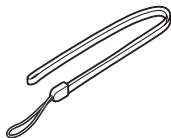

Strap
O-ST51 (*)

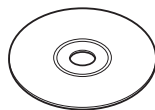

Software (CD-ROM)
S-SW77

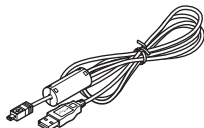

USB cable
I-USB7 (*)

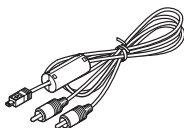

AV cable
I-AVC7 (*)



Rechargeable lithium-ion
battery D-LI78(*)

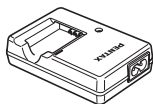

Battery charger
D-BC78 (*)



AC plug cord (*)

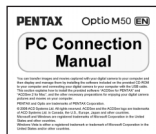

PC Connection Manual



Operating Manual
(this manual)



Quick Guide

Items marked with an asterisk (*) are also available as optional accessories. The battery charger and AC plug cord are only sold as a set (Battery Charger Kit K-BC78).

For other optional accessories, refer to "Optional Accessories" (p.188).

Names of Parts

Front

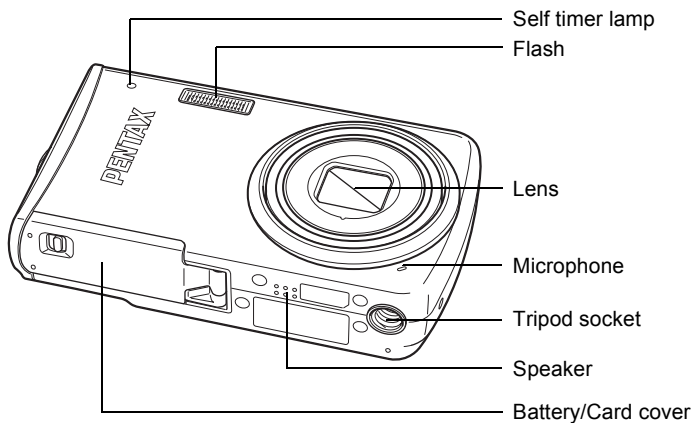

Back

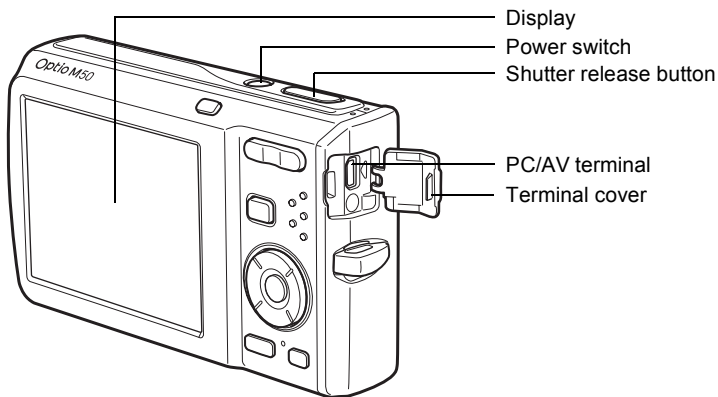

Names of Operating Parts

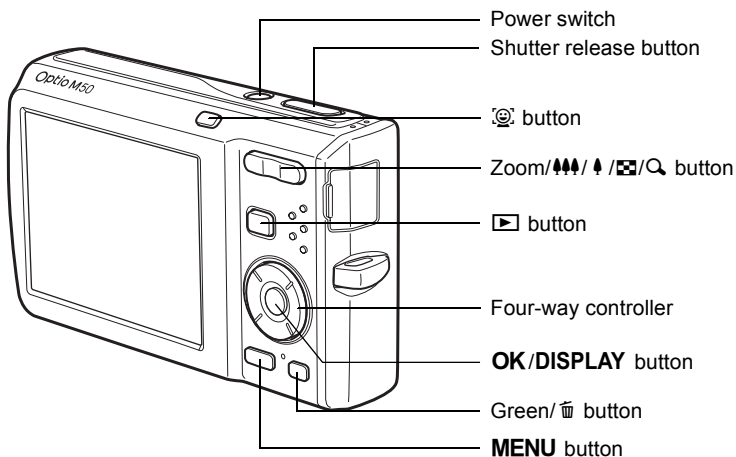

Refer to "Understanding the Button Functions" (p.44 - p.47) for an explanation of the function of each button.

Monitor Indications

Normal Display in Still Picture Capture Mode

The display shows information such as the shooting conditions.

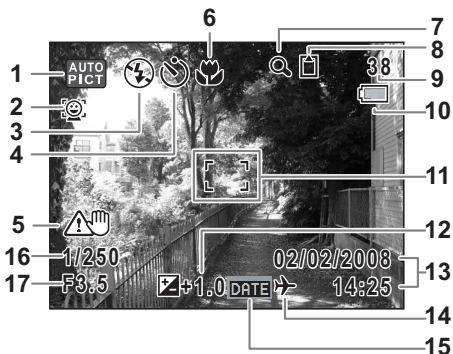

- | | |
|---|------------------------------------|
| 1 Shooting mode (p.53) | 9 Remaining image storage capacity |
| 2 Face Priority icon (p.56) | 10 Battery level indicator (p.25) |
| 3 Flash mode (p.89) | 11 Focus frame (p.40) |
| 4 Drive mode (p.76, p.77) | 12 EV compensation (p.84) |
| 5 Camera shake warning (p.85) | 13 Date and time (p.38) |
| 6 Focus mode (p.87) | 14 World time setting (p.167) |
| 7 Digital zoom icon (p.78)
Intelligent zoom icon (p.78) | 15 Date Imprint icon (p.105) |
| 8 Memory status (p.34)
📷 : Built-in memory (without card)
📁 : SD Memory Card
🔒 : Card is write-protected | 16 Shutter speed |
| | 17 Aperture |
- * 16 and 17 appear only when the shutter release button is pressed halfway.
- * Some indications may not appear depending on the shooting mode.

Histogram + Info Display in Still Picture Capture Mode

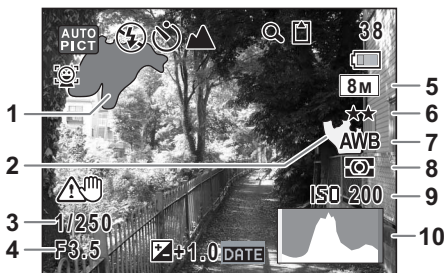

- | | | | |
|---|------------------------------|----|----------------------|
| 1 | Bright portion (blinks red) | 6 | Quality (p.93) |
| 2 | Dark portion (blinks yellow) | 7 | White balance (p.94) |
| 3 | Shutter speed | 8 | AE Metering (p.96) |
| 4 | Aperture | 9 | Sensitivity (p.98) |
| 5 | Recorded pixels (p.91) | 10 | Histogram (p.86) |

* 3 and 4 appear only when the shutter release button is pressed halfway.

* Some indications may not appear depending on the shooting mode.

About the Bright and Dark Portions

When there is an area in the frame that is so bright it appears white, the indicated area blinks red as a warning. Similarly, when there is an area that is so dark it appears black, the indicated area blinks yellow as a warning.

Full Display in Still Picture Playback Mode

(All of the display items are displayed here for explanatory purposes.)

The display shows information such as the shooting conditions. A1 to A12 appear when [Normal Display] or [Histogram + Info] is selected. B1 to B10 only appear when [Histogram + Info] is selected. (p.121)



- | | |
|---|--|
| A1 Playback mode (p.59)
▶ : Still Picture Playback Mode (p.59)
Ⓜ : Digital SR (p.122) | A9 Captured date and time (p.38) |
| A2 Folder number (p.170) | A10 Four-way controller guide |
| A3 File number | A11 Key lock icon (p.64) |
| A4 Protect icon (p.134) | A12 Face Priority icon (p.56) |
| A5 Voice memo icon (p.161) | B1 Bright portion (blinks red) (p.19) |
| A6 Battery level indicator (p.25) | B2 Recorded pixels (p.91) |
| A7 Volume icon (p.161) | B3 Quality (p.93) |
| A8 Memory status (p.34)
📁 : Built-in memory (without card)
📄 : SD Memory Card
🔒 : Card is write-protected | B4 White balance (p.94) |
| B5 AE Metering (p.96) | B6 Sensitivity (p.98) |
| B7 Dark portion (blinks yellow) (p.19) | B8 Shutter speed |
| B9 Aperture | B10 Histogram (p.86) |

In Normal Display, A6 and A9 disappear if no operation is performed for two seconds.

Guide Indications

A guide to available button operations appears on the display during operation. The buttons are indicated as shown below.

Four-way controller (▲)	▲
Four-way controller (▼)	▼
Four-way controller (◀)	◀
Four-way controller (▶)	▶
MENU button	MENU

Zoom button	🔍
OK/DISPLAY button	OK
Shutter release button	SHUTTER
Green/🗑 button	🟢, 🗑
📷 button	📷, 📷

Attaching the Strap

Attach the strap (O-ST51) supplied with the camera.

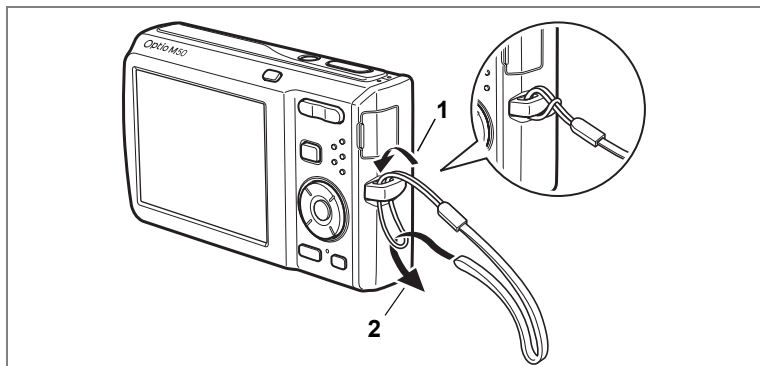

- 1** Pass the narrow end of the strap through the strap lug.
- 2** Pass the other end of the strap through the loop and pull tight.

Powering the Camera

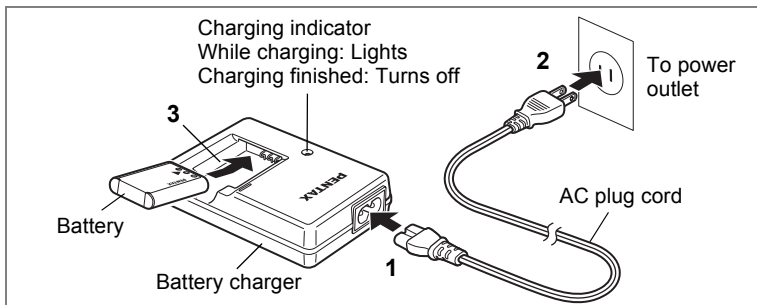

Charging the Battery

Use the battery charger to charge the battery before using it in the camera for the first time or after a long period of non-use, or when the [Battery depleted] message appears.

Note: AC plug cord "Listed, Type SPT-2 or NISPT-2, 18/2 flexible cord, rated 125 V, 7A, minimum 6ft (1.8m)"

- 1 Connect the AC plug cord to the battery charger D-BC78.**
- 2 Plug the AC plug cord into the power outlet.**
- 3 Place the battery in the charger so that the PENTAX logo is facing up.**
The charging indicator lights while the battery is charging and turns off when charging is finished.
- 4 Remove the battery from the battery charger when charging is finished.**



- The time required to fully charge the battery is about 150 minutes (max.). The appropriate ambient temperature for charging the battery is 0°C to 40°C (32°F to 104°F). (The charging time may vary depending on the ambient temperature and charging conditions.)
- The battery has reached the end of its service life when it starts to run down soon after being charged. Replace with a new battery.



- Do not use the battery charger to charge batteries other than the rechargeable lithium-ion battery D-LI78, as the charger may overheat or be damaged.
- If the battery is inserted correctly but the charging indicator fails to light, the battery may be faulty. Replace with a new battery.

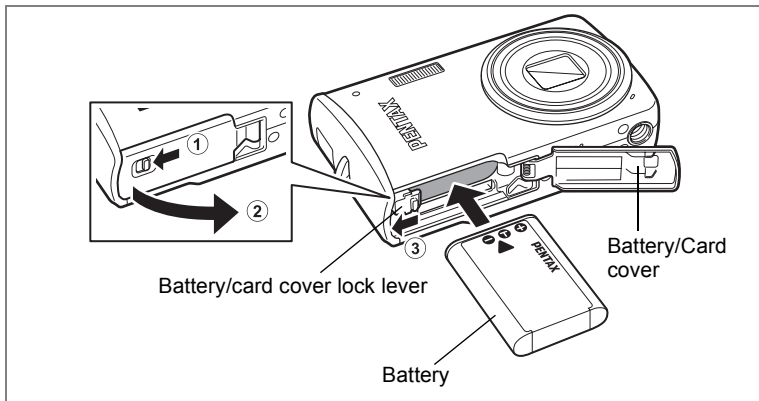

Installing the Battery

Use the battery that is provided with the camera. Charge the battery before using it in the camera for the first time.

1 Open the battery/card cover.

Move the battery/card cover lock lever to the OPEN position ① and open the battery/card cover ②.

2 Using the side of the battery to press the battery/card cover lock lever in the direction of ③, insert the battery with the PENTAX logo pointing toward the lens.

Push the battery in until it is locked in place.



Make sure that the battery is inserted with the PENTAX logo pointing toward the lens. If the battery is incorrectly oriented, malfunction may result.

3 Close the battery/card cover.

Close the battery/card cover and move the battery/card cover lock lever to the LOCK position.

Removing the Battery

- 1 **Open the battery/card cover.**
- 2 **Press the battery/card cover lock lever in the direction of**
 - ③ **to release the battery.**

The battery will be ejected. Pull the battery out of the camera.



- This camera uses a rechargeable lithium-ion battery D-LI78. Use of any other type of battery may damage the camera and cause malfunction.
- Insert the battery correctly. If the battery is incorrectly oriented, malfunction may result.
- Do not remove the battery while the camera is turned on.
- When storing the battery for more than 6 months, charge the battery for 30 minutes using the battery charger and store the battery separately.
Be sure to recharge the battery every 6 to 12 months. Storing the battery below room temperature is ideal. Avoid storing it in high temperatures.
- The date and time may be returned to the default setting if the camera is left without the battery for a long time.
- Be careful as the camera or the battery may become hot when the camera is used continuously for a long period of time.

- **Image Storage Capacity, Movie Recording Time, Sound Recording Time, and Playback Time**
(at 23°C with the display on and the battery fully charged)

Image Storage Capacity* ¹ (flash used for 50% of shots)	Movie Recording Time* ²	Sound Recording Time* ²	Playback Time* ²
Approx. 210 pictures	Approx. 70 min.	Approx. 300 min.	Approx. 240 min.

*1: Recording capacity shows approximate number of shots recorded during CIPA-compliant testing (with display on, flash used for 50% of the shots, and 23 degrees centigrade). Actual performance may vary according to operating conditions.





*2: According to the result of in-house testing.



- In general, battery performance may temporarily deteriorate as the temperature decreases.
- Be sure to take a spare battery with you when traveling abroad or to a cold region, or if you intend to take a lot of pictures.

• **Battery Level Indicator**

You can check the battery level by the  indicator on the display.

Screen Display	Battery Status
 (green)	Adequate power remains.
 (green)	Battery is running low.
 (yellow)	Battery is running very low.
 (red)	Battery is exhausted.
[Battery depleted]	The camera will turn off after this message appears.

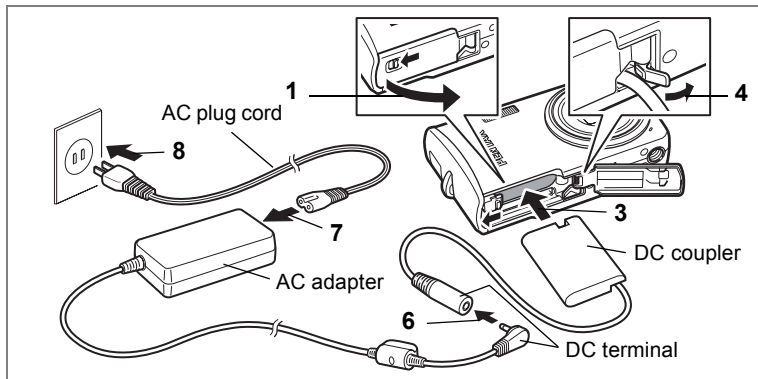

Using the AC Adapter

Use of the AC adapter kit K-AC78 (optional) is recommended if you intend to use the camera for a long time or connect it to a PC.

- 1 Make sure that the camera is turned off and open the battery/card cover.**
- 2 Remove the Battery.**
Refer to p.24 on how to open/close the battery/card cover and remove the battery.
- 3 Insert the DC coupler.**
Using the side of the DC coupler to press the battery/card cover lock lever, insert the DC coupler. Confirm the DC coupler is locked in place.
- 4 Extract the DC coupler cord.**
Pull out the tab at the joint of the camera and the battery/card cover so that the DC coupler cord extracts from there.
- 5 Close the battery/card cover.**
- 6 Connect the DC terminal of the AC adapter to the DC terminal of the DC coupler.**
- 7 Connect the AC plug cord to the AC adapter.**
- 8 Plug the AC plug cord into the power outlet.**

- Make sure that the camera is turned off before connecting or disconnecting the AC adapter.
- Make sure that the AC plug cord and the power cord connecting the AC adapter to the camera are inserted securely. The data may be lost if either becomes disconnected while data is being recorded on the SD Memory Card or the built-in memory.
- Use the AC adapter with due care to avoid fire or electric shock. Be sure to read “USING YOUR CAMERA SAFELY” (p.1) and “About the Battery Charger and the AC Adapter” (p.2) before using the AC adapter.
- Be sure to read the operation manual accompanying the AC adapter kit K-AC78 before using the adapter.
- The battery cannot be charged inside the camera even when the AC adapter is connected.
- When connecting the AC adapter, you cannot set the camera upright on the table because the cord from the DC coupler is extracted from the bottom side of the camera. Additionally, do not place the camera with the lens facing down because the lens extends when the camera turns on. When connecting the AC adapter and confirm the display for playing back pictures or setting the camera, hold the camera in your hand or use a tripod.

Installing the SD Memory Card

1

Getting Started

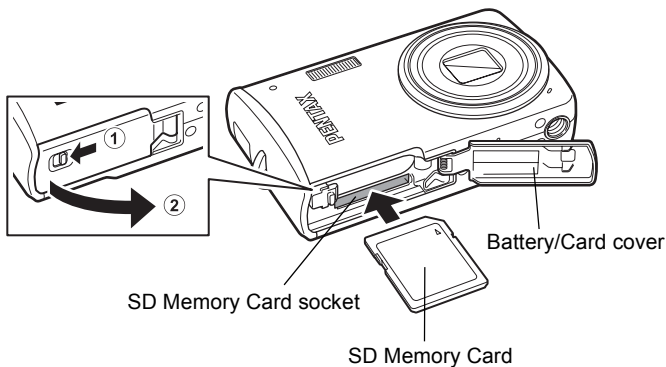

This camera uses an SD Memory Card. Captured images and sound files are saved on the SD Memory Card if a card is inserted in the camera. They are saved in the built-in memory if a card is not inserted. (p.34)



- **Be sure to use this camera to format (initialize) an SD Memory Card that is unused or has been used on other cameras or digital devices. Refer to “Formatting an SD Memory Card or the Built-in Memory” (p.162) for instructions on formatting.**
- Make sure that the camera is turned off before inserting or removing the SD Memory Card.



- The still picture storage capacity varies depending on the capacity of the SD Memory Card and the selected number of recorded pixels and quality level. (p.31)
- The self-timer lamp blinks while the SD Memory Card is being accessed (data is being recorded or read).

Backing Up Data

The camera may not be able to access data in the built-in memory in the case of a malfunction. Use a computer or other device to back up important data in another location.

1 Open the battery/card cover.

Move the battery/card cover lock lever to the OPEN position ① and open the battery/card cover ②.

2 Insert the SD Memory Card into the SD Memory Card socket so that the label is facing toward the front of the camera (the side with the lens).

Push the card in all the way. Images and sound may not be recorded correctly if the card is not inserted all the way.

3 Close the battery/card cover.

Close the battery/card cover and move the battery/card cover lock lever to the LOCK position.

Removing the SD Memory Card**1 Open the battery/card cover.****2 Push the card into the SD Memory Card socket to eject it.**

Pull the card out.

Precautions When Using an SD Memory Card

- The SD Memory Card is equipped with a write-protect switch. Setting the switch to LOCK protects the existing data by prohibiting recording of new data, deletion of existing data or formatting of the card.  appears on the display when the card is write-protected.
- Care should be taken when removing the SD Memory Card immediately after using the camera, as the card may be hot.
- Do not remove the SD Memory Card or turn the camera off while data is being saved to the card, images or sound files are being played back, or the camera is connected to a computer with the USB cable, as this may cause the data to be lost or the card to be damaged.
- Do not bend the SD Memory Card or subject it to violent impact. Keep it away from water and store away from high temperature.
- Do not remove the SD Memory Card during formatting as this may damage the card and render it unusable.
- The data on the SD Memory Card may be deleted in the following circumstances. PENTAX does not accept any liability for data that is deleted
 - (1) when the SD Memory Card is mishandled by the user.
 - (2) when the SD Memory Card is exposed to static electricity or electrical interference.
 - (3) when the card has not been used for a long time.
 - (4) when the card is ejected or the battery is removed while the data on the card is being recorded or accessed.
- If it is not used for a long time, the data on the card may become unreadable. Be sure to regularly make a backup of important data on a computer.
- Avoid using or storing the card where it may be exposed to static electricity or electrical interference.
- Avoid using or storing the card in direct sunlight or where it may be exposed to rapid changes in temperature or to condensation.
- When using an SD Memory Card with a slow recording speed, recording may stop while you are taking movies even when there is adequate space in the memory, or shooting and playback may take a long time.
- For information on compatible SD Memory Cards, visit the PENTAX website.
- Be sure to format an SD Memory Card that is unused or has been used on another camera. Refer to "Formatting an SD Memory Card or the Built-in Memory". (p.162)
- Please note that formatting the SD Memory Card will not necessarily delete the data so that it cannot be recovered using off-the-shelf data recovery software. There are off-the-shelf secure data deletion software programs available that will completely delete the data. If you are going to discard, give away or sell your SD Memory Card, you should ensure that the data on the card is completely deleted or the card itself is destroyed if it contains any personal or sensitive information. In any case, the data on your SD Memory Card should be managed at your own risk.

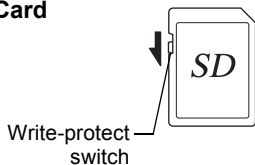

Recorded Pixels and Quality Level of Still Pictures

Choose the number of pixels (size) and quality level (data compression rate) of still pictures according to how you intend to use the pictures you have taken.

Higher quality levels and numbers of pixels produce clearer images, but the resulting increase in data volume reduces the total number of pictures that can be taken (stored in the camera's built-in memory or on the SD Memory Card).

The quality of the captured photo or printed picture also depends on the quality level, exposure compensation, resolution of the printer and a variety of other factors, so you do not need to select more than the required number of pixels. As a rough guide, **2M** (1600×1200) is adequate for making postcard-size prints. Refer to the table below for the appropriate settings according to use.

● Appropriate Number of Recorded Pixels According to Use

Recorded Pixels	Use	
8M 3264×2448	↑ Clearer	For printing high quality photos or A4-size pictures, or editing images on a PC.
5M 2592×1944		
4M 2304×1728		For making postcard-size prints.
3M 2048×1536		
2M 1600×1200		
1024 1024× 768		For posting on a website or attaching to e-mail.
640 640× 480		

The default setting is **8M** (3264×2448).

● Appropriate Quality Level According to Use

★★★	Best	Lowest compression rate. Suitable for photo prints.
★★	Better	Standard compression rate. Suitable for viewing the image on a computer screen.
★	Good	Highest compression rate. Suitable for posting on a website or attaching to e-mail.

The default setting is **★★ (Better)**.

Choose the appropriate number of recorded pixels and quality level for still pictures on the [📷 Rec.Mode] menu.

Selecting the Recorded Pixels 📷p.91

Selecting the Quality Level 📷p.93

● Recorded Pixels, Quality Level and Image Storage Capacity (Approximate numbers of pictures)

	★★★ (Best)		★★ (Better)		★ (Good)	
	Built-in Memory	512 MB	Built-in Memory	512 MB	Built-in Memory	512 MB
8M 3264×2448	13 pictures	121 pictures	25 pictures	232 pictures	38 pictures	351 pictures
5M 2592×1944	20 pictures	188 pictures	38 pictures	355 pictures	54 pictures	503 pictures
4M 2304×1728	25 pictures	236 pictures	49 pictures	457 pictures	69 pictures	643 pictures
3M 2048×1536	31 pictures	293 pictures	61 pictures	570 pictures	88 pictures	816 pictures
2M 1600×1200	51 pictures	472 pictures	83 pictures	774 pictures	121 pictures	1119 pictures
1024 1024× 768	96 pictures	888 pictures	155 pictures	1439 pictures	192 pictures	1777 pictures
640 640× 480	192 pictures	1777 pictures	297 pictures	2747 pictures	363 pictures	3358 pictures

- The above figures may vary depending on the subject, shooting conditions, shooting mode and SD Memory Card, etc.

Recorded Pixels, Quality Level and Frame Rate of Movies

Choose the recorded pixels, quality level and frame rate (number of frames per second) according to how you intend to use the movies you have taken.

The higher the number of recorded pixels and quality level, the clearer the details, but the bigger the file size.

The more frames per second, the better the quality of the movie, but the bigger the file size.

Choose the appropriate number of recorded pixels, quality level and frame rate in [Movie] on the [📷 Rec.Mode] menu.

Selecting the Recorded Pixels for Movies 📷p.110

Selecting the Quality Level of Movies 📷p.111

Selecting the Frame Rate 📷p.112

● Appropriate Number of Recorded Pixels According to Use

640 (640×480)	Suitable for viewing on a TV or computer screen.
320 (320×240)	Suitable for posting on a website or attaching to e-mail.

The default setting is **640** (640×480).

● Appropriate Quality Level According to Use

★★★	Best	↑ Clearer images ↓ Grainier images
★★	Better	
★	Good	

The default setting is ★★★ (Best).

● Appropriate Frame Rate According to Use

30fps	Produces high quality movies, but reduces the total recording time.
15fps	Increases the total recording time because the file size is smaller.

The default setting is 30fps (frames per second).

● Recorded Pixels, Quality Level, Frame Rate and Recording Time (Approximate recording time)

		30fps		15fps		Sound	
		Built-in Memory	512 MB	Built-in Memory	512 MB	Built-in Memory	512 MB
640 640×480	★★★	48 sec.	7 min. 31 sec.	1 min. 36 sec.	14 min. 48 sec.	41 min. 17 sec.	6 hr. 14 min. 15 sec.
	★★	1 min. 5 sec.	10 min. 4 sec.	2 min. 10 sec.	20 min. 8 sec.		
	★	1 min. 39 sec.	15 min. 15 sec.	3 min. 12 sec.	29 min. 37 sec.		
320 320×240	★★★	1 min. 17 sec.	11 min. 59 sec.	2 min. 28 sec.	22 min. 53 sec.		
	★★	1 min. 45 sec.	16 min. 14 sec.	3 min. 24 sec.	31 min. 28 sec.		
	★	2 min. 28 sec.	22 min. 53 sec.	4 min. 57 sec.	45 min. 47 sec.		

- The above figures are based on PENTAX standard shooting conditions and may vary depending on the subject, shooting conditions and type of SD Memory Card used.
- Recording can continue until the built-in memory/SD Memory Card is full, or the size of the recorded movie reaches 2 GB (when using an SDHC card). If recording stops at 2 GB, start recording again to continue to record the rest of the movie in blocks of 2 GB.

Turning the Camera On and Off

1

Getting Started

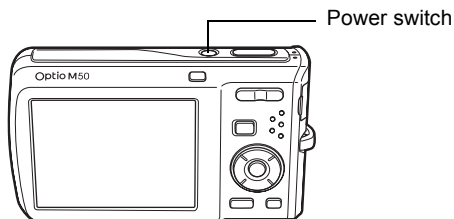

1 Press the power switch.

The camera turns on and the display turns on.

When you turn the camera on, the lens cover opens and the lens extends.

If the Language Selection screen or Date Adjust screen appears when you turn the camera on, follow the procedure on p.36 to set the display language and/or current date and time.



2 Press the power switch again.

The display turns off, the lens closes, and the camera turns off.

Taking Pictures  p.61

Checking the Memory Card

The memory card is checked automatically when the camera turns on.  appears on the display when there is no SD Memory Card inserted in the camera. In this case, images and sound files will be saved in the built-in memory.

 appears instead of  when the write-protect switch on the SD Memory Card is in the locked position. Images and sound cannot be recorded when the write-protect switch is locked.

Memory status



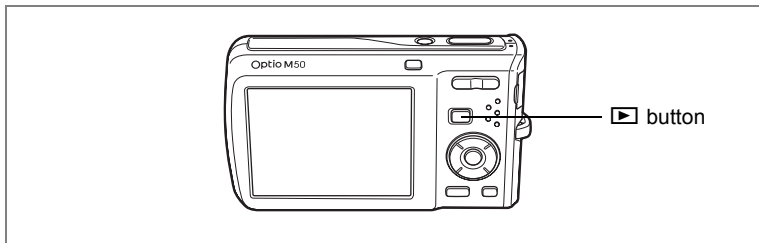

Playback Mode

Use this mode when you want to play back an image or sound file straightaway without taking any more pictures.

1 Press the power switch while holding down the ▶ button.

The display turns on with the lens retracted and the camera turns on in Playback Mode.



To switch from Playback Mode to  mode, press the ▶ button or press the shutter release button halfway.

Playing Back Still Pictures  p.42

Initial Settings

1

Getting Started

Set the language, time, and date after purchasing the camera before you start taking pictures.

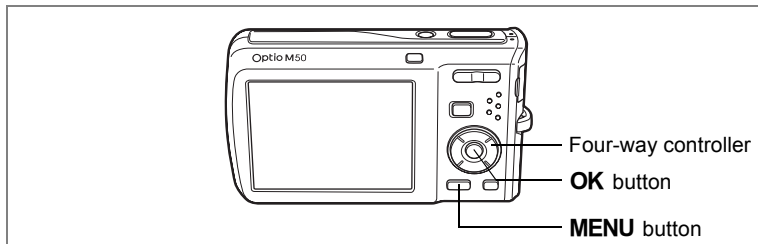

The [Language/言語] screen appears when the camera is turned on for the first time. Perform the operations in “Setting the Display Language” below to set the language, and in “Setting the Date and Time” (p.38) to set the current date and time.

Language, Date, and Time can be changed later. Refer to the pages below for instructions.

- To change the language, follow the steps in “Changing the Display Language” (p.169).
- To change the date and time, follow the steps in “Changing the Date and Time” (p.165).

Setting the Display Language

- 1 Use the four-way controller (▲▼◀▶) to choose the display language.



2 Press the OK button.

The Initial Setting screen appears in the selected language. If the desired settings for [Hometown] and daylight saving time appear, press the **OK** button again to display the [Date Adjust] screen. Go to “Setting the Date and Time” (p.38).

Go to Step 3 in “Setting Hometown and DST” if the desired settings do not appear.

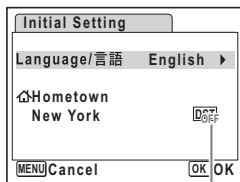

Daylight saving time

If you accidentally select another language and go to the next procedure, perform the following operation to set the language back.

● When Another Language Has Been Inadvertently Selected

- 1 Press the four-way controller (▶).
- 2 Use the four-way controller (▲ ▼ ◀ ▶) to select the language and press the **OK** button.

The Initial Setting screen appears in the selected language.

● When the Screen After Step 2 Appears in Another Language

- 1 Press the **OK** button.
- 2 Press the **MENU** button.
- 3 Press the four-way controller (▶).
- 4 Use the four-way controller (▼ ▲) to select [Language/言語].
- 5 Press the four-way controller (▶).
The [Language/言語] screen appears.
- 6 Use the four-way controller (▲ ▼ ◀ ▶) to select the language.
- 7 Press the **OK** button.

The [↖ Setting] menu appears in the selected language.

The language is now switched to your desired language. To reset Hometown and the Date and Time, refer to the pages below for instructions.

- To change Hometown, follow the steps in “Setting the World Time” (p.167).
- To change the Date and Time, follow the steps in “Changing the Date and Time” (p.165).

Setting Hometown and DST

- 3 **Press the four-way controller (▼).**
The frame moves to [Hometown].
- 4 **Press the four-way controller (▶).**
The Hometown screen appears.
- 5 **Use the four-way controller (◀▶) to choose the city.**
- 6 **Press the four-way controller (▼).**
The frame moves to [DST] (Daylight Saving Time).
- 7 **Use the four-way controller (◀▶) to select (On) or (Off).**
- 8 **Press the OK button.**
The Initial Setting screen appears.
- 9 **Press the OK button.**
The Date Adjust screen appears. Next, set the date and time.

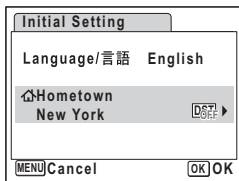

Setting the Date and Time

Set the current date and time and the display style.

- 1 **Press the four-way controller (▶).**
The frame moves to [mm/dd/yy].
- 2 **Use the four-way controller (▲▼) to choose the date and time display style.**
- 3 **Press the four-way controller (▶).**
The frame moves to [24h].
- 4 **Use the four-way controller (▲▼) to select [24h] (24-hour display) or [12h] (12-hour display).**
- 5 **Press the four-way controller (▶).**
The frame returns to [Date Style].

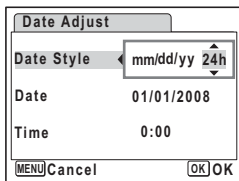
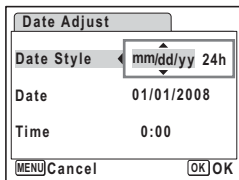

6 Press the four-way controller (▼).

The frame moves to [Date].

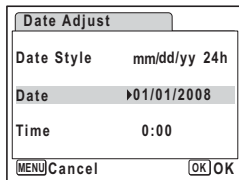

7 Press the four-way controller (▶).

The frame moves to the month.

8 Use the four-way controller (▲▼) to change the month.

Change the day and year in the same manner. Next, change the time.

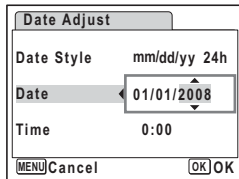

If you selected [12h] in Step 4, the setting switches between am and pm corresponding to the time.

9 Press the OK button.

The setting is set and the camera returns to capture status.

Language, Date, Time, Hometown, and DST can be changed. Refer to the pages below for instructions.

- To change the language, follow the steps in “Changing the Display Language” (p.169).
- To change the date and time, follow the steps in “Changing the Date and Time” (p.165).
- To change the city or turn DST on and off, follow the steps in “Setting the World Time” (p.167).



When the Initial Setting or Date Adjust screen is displayed, you can cancel the setting operation and switch to Capture mode by pressing the **MENU** button. In this case, the Initial Setting screen will appear next time you turn the camera on.



If you press the **OK** button in Step 9, the camera clock is reset to 00 seconds. To set the exact time, press the **OK** button when the time signal (on the TV, radio, etc.) reaches 00 seconds.

The video output format (NTSC/PAL) is set to the format of the city selected in [Hometown] on the Initial Setting screen. Refer to “List of World Time Cities” (p.180) for the video output format of each city set as the Initial Setting, and “Changing the Video Output Format” (p.172) for changing the setting of the video output format.

Taking Still Pictures

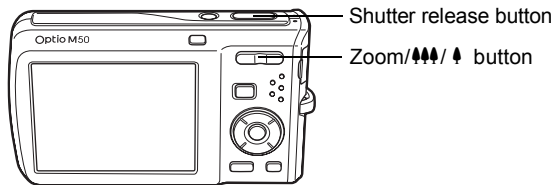

The standard procedure for taking still pictures is described below. The flash fires automatically depending on the light conditions.

1 Press the power switch.

The camera turns on and is ready to take still pictures. In this manual, this is called Still Picture Capture mode.

2 Confirm the subject and shooting information on the display.

The focus frame in the middle of the display indicates the zone of automatic focusing.

You can change the captured area by pressing the Zoom/AAA/▲ button to the left or right.

▲ : enlarges the subject

AAA : widens the area that is captured by the camera

3 Press the shutter release button halfway.

The focus frame on the display turns green if the subject is in focus.

4 Press the shutter release button fully.



The picture is taken.

The image appears on the display for one second (Instant Review) and is saved to the SD Memory Card or built-in memory. (p.41)



Focus frame



Press the Green button to switch to the  (Green) mode and let the camera set all the shooting functions automatically. Selecting the  mode is the easiest way to ensure that pictures come out well. (p.63)

Using the Shutter Release Button

The shutter release button works in a two-step action as follows.

Press halfway

The focus and exposure are locked when the shutter release button is pressed halfway. The green focus frame lights on the display when the shutter release button is pressed halfway and the subject is in focus. If the subject is out of focus, the frame turns red.

Press fully

Press the shutter release button all the way down to take the picture.

[Poor focusing conditions]

The camera may not be able to focus under the following conditions. In these cases, lock the focus on an object the same distance away as the subject (by pressing and holding the shutter release button halfway), then aim the camera at your subject and press the shutter release button fully.

- Objects that lack contrast such as a blue sky or white wall
- Dark places or objects, or conditions that prevent light being reflected back
- Horizontal lines or intricate patterns
- Fast moving objects
- When there is an object in the foreground and an object in the background in the same picture
- Strongly reflected light or strong backlighting (bright background)

Instant Review

The image appears on the display for one second (Instant Review) immediately after it is captured. You can change the Instant Review time. (p.101)
You can delete the image during Instant Review by pressing the  button.



- When the camera detects that the subject blinked, the message “Closed eyes have been detected.” appears during Instant Review (This function is called “Blinking Detection”). While the message appears, press the Green button and choose [Delete] from the menu to delete the taken image.
- Even when Instant Review is set shorter than [3sec], the message appears for 3 seconds.
- When the Face Recognition function does not work, “Blinking Detection” also does not function. Even if the subject’s faces are recognized, “Blinking Detection” does not function when the recognized faces are too small.

Playing Back Still Pictures

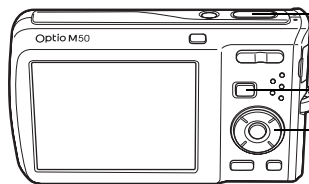

Shutter release button

▶ button

Four-way controller

Playing Back Images

- 1 Press the ▶ button after taking a picture.

The image appears on the display. In this manual, this is called ▶ mode (Playback mode). Displaying one image in full in ▶ mode (▶ mode default setting) is called single-image display.

Press the ▶ button again in ▶ mode or press the shutter release button halfway to switch to 📷 mode.

File number



Playing Back the Previous or Next Image

- 1 Press the ▶ button after taking a picture.

The image appears on the display.

- 2 Press the four-way controller (◀▶).

The previous or next image appears.

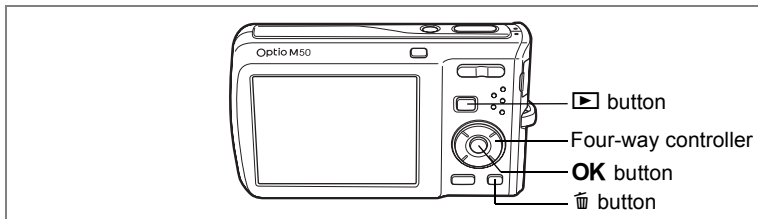

Rotating the Displayed Image

1 Press the button after taking a picture.

The image appears on the display.

2 Press the four-way controller ().

The Playback Mode Palette appears.

3 Use the four-way controller () to select (Image Rotation) and press the OK button.

The rotation selection screen (0°, Right 90°, Left 90°, or 180°) appears.

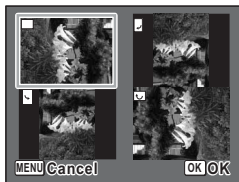

4 Use the four-way controller () to choose the rotation direction and press the OK button.

The rotated image appears.



- Movies cannot be rotated.
- Protected images can be rotated, but they cannot be saved in a rotated state.

Deleting the Displayed Image



Press the button while the image is displayed to display the Delete screen. Use the four-way controller () to select [Delete] and press the OK button. (p.128)

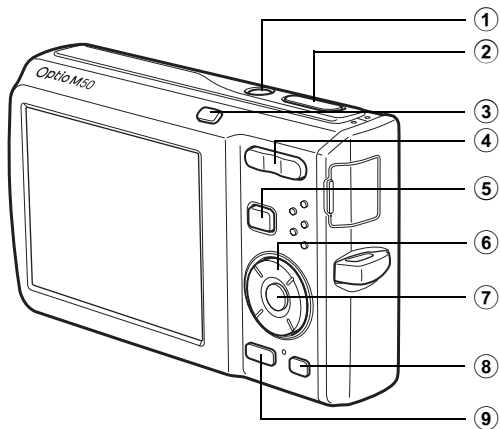

Understanding the Button Functions



Mode

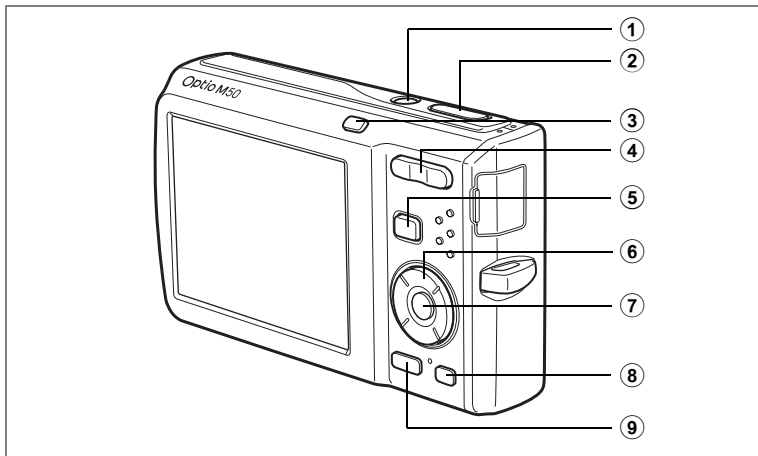

- ① **Power switch**
Turns the camera on and off. (p.34)
- ② **Shutter release button**
Focuses the camera on the subject when pressed halfway in Still Picture Capture mode. (Except in **PF**, **▲** and **MF** modes) (p.40)
Takes the still picture when pressed down fully. (p.40)
Starts and stops movie recording in **MOVIE** mode. (p.108)
Starts and stops sound file recording in **RECORD** mode. (p.157)
- ③ **Smile button**
Switches the Face Recognition function (p.56). The Face Recognition function is switched as follows each time the  button is pressed:
Smile Capture On → Face Priority Off → Face Priority On
- ④ **Zoom/▲▲/▲ button**
Changes the captured area. (p.78)
- ⑤ **▶ button**
Switches to the  mode. (p.115)

- ⑥ **Four-way controller**
(▲) : Changes the drive mode. (p.76, p.77)
(▼) : Displays the Capture Mode Palette. (p.53)
(◀) : Changes the flash mode. (p.89)
(▶) : Changes the focus mode. (p.87)
(▲▼) : Adjusts **MF** in **MF** mode. (p.88)
- ⑦ **OK/DISPLAY button**
Changes the information on the display. (p.85)
- ⑧ **Green button**
Switches to the ● (Green) mode. (p.63)
Calls up the assigned menu. (p.57)
- ⑨ **MENU button**
Displays the [📷 Rec.Mode] menu. (p.48)



▶ Mode

- ① **Power switch**
Turns the camera on and off. (p.34)
- ② **Shutter release button**
Switches to mode. (p.115)
- ③ **☺ button**
Zooms up on the subject's faces in the face-recognized image in order of the recognition during shooting. (Face close-up playback)
- ④ **Zoom//Q button**
Press during single-image display to change to nine-image display. Returns to the previous display when Q is pressed. (p.116)
Enlarges the image when Q is pressed during single-image display. Returns to the previous display when is pressed. (p.118)
Press during nine-image display to change to folder or calendar display. (p.117)
Press Q during folder display to change to nine-image display of the selected folder. (p.117)
Press Q during calendar display to change to nine-image display for the selected date. (p.117)
Adjusts the volume during playback of movies or sound files. (p.125, p.159)

- ⑤ **▶ button**
Switches to  mode. (p.115)
- ⑥ **Four-way controller**
 (▲) : Plays back and pauses a movie or sound file. (p.125, p.159)
 (▼) : Displays the Playback Mode Palette. (p.60)
 Stops a movie or sound file during playback. (p.125, p.159)
 (◀▶) : Displays the previous or next image and sound file during single-image display. (p.42)
 Frame forwards, frame reverses, reverses a movie and makes a movie play forwards during playback. (p.125)
 Fast forwards, reverses, and moves to the next index in sound file playback. (p.159)
 (▲▼◀▶) : Moves the display area during zoom display. (p.118)
 Selects an image in nine-image display, a folder in folder display, and a date in calendar display. (p.116, p.117)
 Moves the image when using the Frame Composite function. (p.145)
- ⑦ **OK/DISPLAY button**
 Changes the information on the display. (p.121)
 Returns zoom display or nine-image display to single-image display. (p.116, p.118)
 Changes to nine-image display of the selected folder during folder display. (p.117)
 Changes to single-image display of the selected date during calendar display. (p.117)
- ⑧ **Green/  button**
 Switches from single-image display to the Delete screen. (p.128)
 Switches from nine-image display to the Select & Delete screen. (p.130)
 Switches from folder display to the calendar display screen. (p.117)
 Switches from calendar display to the folder display screen. (p.117)
- ⑨ **MENU button**
 Displays the [ Setting] menu during single-image display. (p.48)
 Returns to single-image display during Playback Mode Palette display. (p.59)
 Returns zoom display or nine-image display to single-image display. (p.116)
 Changes to nine-image display of the selected folder during folder display. (p.117)
 Changes to nine-image display of the selected date during calendar display. (p.117)

Setting the Camera Functions

To change the camera settings, press the **MENU** button to display the [📷 Rec.Mode] menu or [⏏ Setting] menu. Menus for playing back and editing images and sound files are displayed from the Playback Mode Palette.

Setting with the Menus

Press the **MENU** button in 📷 mode to display the [📷 Rec.Mode] menu. Press the **MENU** button in ▶ mode to display the [⏏ Setting] menu.

During recording

During playback

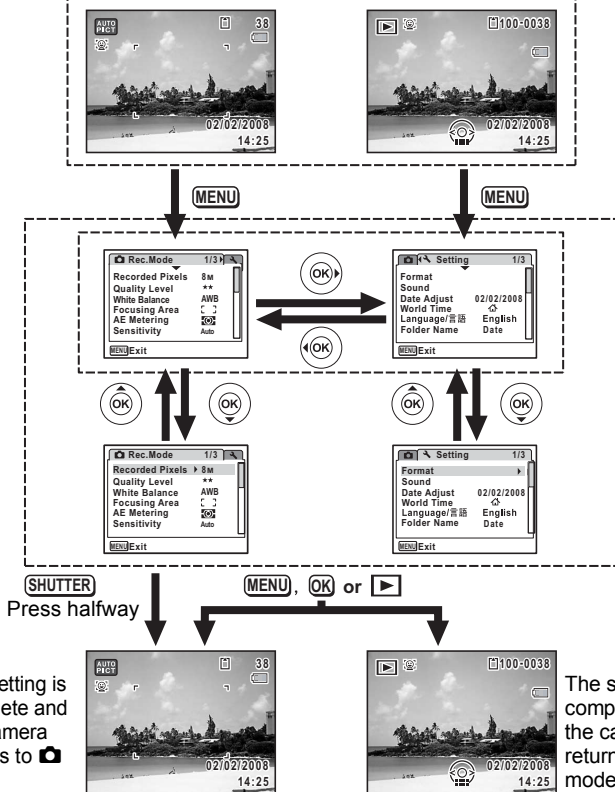

3

Common Operations



A guide to available button operations appears on the display during menu operation.

Ex.) To set the [Quality Level] on the [📷 Rec.Mode] menu

1 Press the MENU button in 📷 mode.

The [📷 Rec.Mode] menu appears.

2 Press the four-way controller (▼).

The frame moves to [Recorded Pixels].

3 Press the four-way controller (▼).

The frame moves to [Quality Level].

4 Press the four-way controller (▶).

A pull-down menu appears with the items that can be selected.

The pull-down menu displays only those items that can be selected with the current camera settings.

5 Use the four-way controller (▲▼) to change the setting.

The quality level changes each time the four-way controller (▲▼) is pressed.

Refer to the following page for instructions on saving settings and canceling changes.

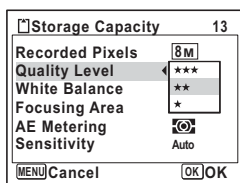
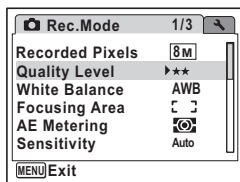
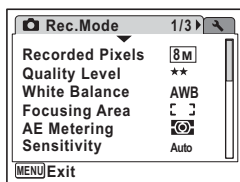

To Save the Setting and Start Taking Pictures

6 Press the shutter release button halfway.

The setting is saved and the camera returns to capture status.
When the shutter release button is pressed fully, the picture is taken.



When the [Setting] menu is displayed from mode, you can switch to mode by pressing the button.

To Save the Setting and Begin Playback of Images

6 Press the button.

When the [Rec.Mode] menu is displayed from mode, the setting is saved and the camera returns to playback status.

To Save the Setting and Continue with Menu Operations

6 Press the OK button or the four-way controller ().

The setting is saved and the screen returns to Step 3.

To Cancel the Changes and Continue with Menu Operations

6 Press the MENU button.

The changes are canceled and the screen returns to Step 3.

The **MENU** button function differs depending on the screen. Refer to the guide indications.

Exit : Exits the menu and returns to the original screen.

: Returns to the previous screen with the current setting.

Cancel : Cancels the current selection, exits the menu and returns to the previous screen.

Menu List

This displays the items that can be set with the menus and provides descriptions of each item. See the list of default settings in the Appendix “Default Settings” (p.181) to decide whether you want the settings saved when the camera is turned off and whether you want the settings returned to the defaults when the camera is reset.

Rec.Mode] Menu

This menu shows the functions related to taking still pictures and recording movies.

Item	Description	Page	
Recorded Pixels	For choosing the number of recorded pixels of still pictures	p.91	
Quality Level	For choosing the quality level of still pictures	p.93	
White Balance	For adjusting the color balance according to the lighting conditions	p.94	
Focusing Area	For changing the area of the autofocus	p.100	
AE Metering	For setting the area of the screen that is metered to determine the exposure	p.96	
Sensitivity	For setting the sensitivity	p.98	
EV Compensation	For adjusting the overall brightness of the picture	p.84	
Movie	Recorded Pixels	For choosing the number of recorded pixels of movies	p.110
	Quality Level	For choosing the quality level of movies	p.111
	Frame Rate	For setting the frame rate (number of frames per second)	p.112
	Color Mode	For choosing a color mode for movies	p.113
	Movie SR	For choosing whether to use the movie shake reduction function	p.114
Digital Wide	For choosing whether to use the Digital Wide function.	p.83	
Digital Zoom	For choosing whether to use the digital zoom function	p.80	
Instant Review	For setting the Instant Review time	p.101	
Memory	For choosing whether to save the set values of the shooting function or return to the defaults when the camera is turned off	p.106	
Green Button	For assigning a function to the Green button in Capture mode	p.58	
Sharpness	For choosing sharp or soft outlines	p.102	
Saturation	For setting the color saturation	p.103	
Contrast	For setting the image contrast level	p.104	
Date Imprint	For choosing whether to imprint the date when taking still pictures	p.105	



- Use the  (Green) mode to enjoy easy picture-taking using standard settings, regardless of the settings in the [📷 Rec.Mode] menu. (p.63)
- Assigning frequently used functions to the Green button enables you to go straight to the menu item. (p.57)

[🔧 Setting] Menu

Item	Description	Page
Format	For formatting the SD Memory Card or built-in memory	p.162
Sound	For adjusting the operation volume and playback volume, and setting the start-up sound, shutter sound, key operation sound and self-timer sound	p.163
Date Adjust	For adjusting the date, time, and date style	p.165
World Time	For setting the world time	p.167
Language/言語	For setting the language in which menus and messages appear	p.169
Folder Name	For choosing how names are assigned to folders for storing images and sound files	p.170
USB Connection	For setting the USB cable connection (to PC or printer)	p.171
Video Out	For setting the output format to the AV equipment	p.172
Brightness Level	For changing the brightness of the display	p.173
Power Saving	For setting the time until the camera enters power-saving mode	p.174
Auto Power Off	For setting the time until the camera turns off automatically	p.175
Quick Zoom	For choosing whether to use the Quick Zoom function (p.118) when playing back images	p.176
Guide Display	For displaying a guide for the function selectable in the Capture Mode Palette and the Playback Mode Palette	p.177
Reset	For returning settings other than the date and time, language, world time and video out to their defaults	p.178

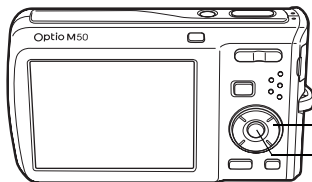

Setting the Shooting Mode

The Optio M50 has a variety of shooting modes that let you take pictures or record movies and sound in different situations simply by choosing the right mode for the particular situation from the Capture Mode Palette.

1 Press the four-way controller (▼) in mode.

The Capture Mode Palette appears.

2 Use the four-way controller (▲▼◀▶) to choose a shooting mode.

A shooting mode guide appears about 2 seconds after the shooting mode is chosen. You can turn off the shooting mode guide by operating the menu. Refer to “Setting the Guide Display” (p.177) for details of how to operate the menu.



3 Press the OK button.

The shooting mode is selected and the camera returns to capture status.







- In shooting modes other than , , , , and , saturation, contrast, sharpness, white balance, etc. are automatically set to the optimal settings for the selected mode.
- Some functions may not be available or may not function fully depending on the selected shooting mode. For details, refer to “Functions Available for Each Shooting Mode” (p.186).
- You can turn off the shooting mode guide on the Capture Mode Palette. (p.177)

There are 17 available shooting modes.

3

Item	Description	Page
Auto Picture	Automatically select the best capture mode.	p.61
Program	The basic mode for capturing images. Various functions can also be set with this mode.	p.62
Night Scene	Used for night scenes. Use a tripod, etc. to reduce shaking and use a flash for portraits.	p.65
Movie	For capturing movies. Sound is also recorded.	p.108
Voice Recording	For recording sound only. Be careful not to cover the microphone with your hands.	p.157
Landscape	For capturing landscape views. The camera focuses on a wide range.	
Flower	For capturing brightly colored flowers. Reproduces the outline of the flower softly.	
Natural Skin Tone	Adjusts color and brightness to reproduce skin more beautifully than Portrait.	p.68
Portrait	For capturing portraits. The skin tone will be brighter to make the person look healthy.	p.68
Surf & Snow	For capturing images with dazzling backgrounds, such as beaches or snowy mountains.	
Sport	For subjects in fast motion. Keeps the camera in focus until the shutter is released.	
Digital SR (Blur Reduction)	Higher sensitivity reduces blur from both subject and camera movement.	p.65
Pet	For capturing images of pets in motion. A setting suitable for the pet's coat can be set.	p.70
Kids	For capturing moving kids. Reproduces healthy and bright skin tone.	p.72

Item		Description	Page
	Food	For capturing images of food. Saturation will be rather high to make it look appetizing.	
	Digital Panorama	Stitches images taken with the camera to create a panoramic photograph.	p.74
	Digital Wide	Composites two images resulting in wider field of view.	p.81



 (Digital Wide) mode cannot be chosen from the Capture Mode Palette. Refer to p.81 on how to choose this mode.

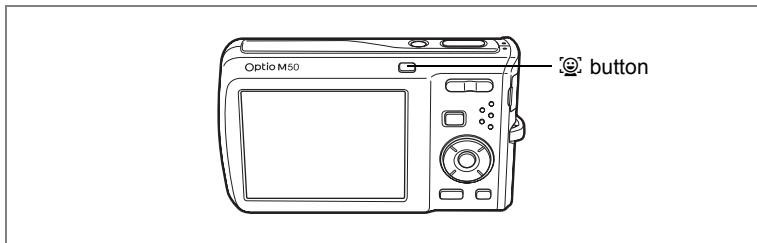

Setting the Face Recognition function

With the Optio M50, the Face Recognition function is available with all shooting modes except mode.

In the Face Recognition function, you can choose the Face Priority function that recognizes the subject's face, focuses (Face Recognition AF) and performs exposure compensation (Face Recognition AE), and the Smile Capture function* that recognizes the subject's face, focuses (Face Recognition AF), performs exposure compensation (Face Recognition AE) and captures an image automatically.

* If the face detected by the camera is too small, an image may not be captured automatically because the Smile Capture function will not work.

Switching the Face Recognition Function

By default, the Face Recognition function is set to Face Priority On. The Face Recognition function is switched as follows each time the button is pressed: Smile Capture On → Face Priority Off → Face Priority On

Face Priority On



Smile Capture On



Face Priority Off



An icon indicating either Face Priority On or Smile Capture On appears on the display. (The icon does not appear when the Face Recognition function is not activated.)



- The Face Recognition function cannot be set to off in (Auto Picture), (Natural Skin Tone), (Portrait) or (Kids) mode. You can select either Face Priority On or Smile Capture On.
- Face Priority On is automatically selected in (Auto Picture), (Natural Skin Tone), (Portrait), (Kids) or (Movie) mode. When switching to another mode from one of these modes, the Face Recognition setting returns to the previous setting.
- Refer to p.68 and p.72 on how to shoot with the Face Recognition function.

Calling Up a Specific Menu

Assign menu items to the Green Button and recall these quickly by simply pressing the Green Button. This is useful for going straight to the setting screens of frequently used functions such as EV Compensation, Sensitivity and White Balance.



- The following functions can be assigned to the Green button: Green Mode, Recorded Pixels, Quality Level, White Balance, Focusing Area, AE Metering, Sensitivity, EV Compensation, Sharpness, Saturation and Contrast.
- The Green Button setting can be returned to its default setting by selecting [Reset] on the [Setting] menu.
- The functions assigned to the Green button can be used in the usual manner on the original menu ([Rec.Mode]).
- You cannot save different settings for the same function on the Green button and on the original menu.

Assigning a Function to the Green Button

- 1 Select [Green Button] on the [📷 Rec.Mode] menu.**
- 2 Press the four-way controller (▶).**
A pull-down menu appears.
- 3 Use the four-way controller (▲▼) to choose a function and press the OK button.**
- 4 Press the MENU button.**

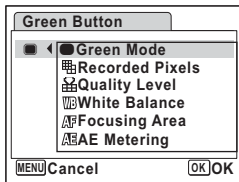

The camera returns to capture status with the current setting.

Using the Green Button

- 1 Press the Green button in 📷 mode.**
The function assigned to [Green Button] on the [📷 Rec.Mode] menu is called up.
- 2 Use the four-way controller (◀▶) to change the settings and press the OK button.**



The camera returns to capture status.





If a function other than the ● (Green) mode has been assigned to the Green button, the camera returns to the original screen if no operation is performed for 5 seconds after the Green button is pressed.

Using the Playback Function

Press the four-way controller (▼) in  mode to display the Playback Mode Palette.

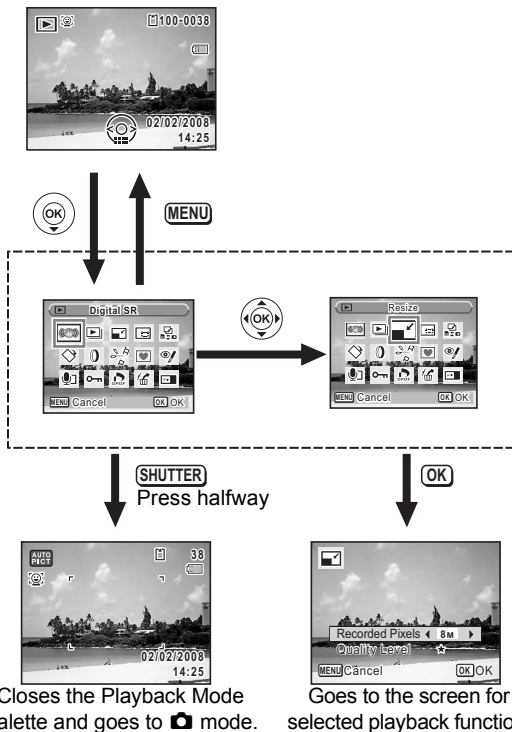
You can display the playback function you want to use simply by using the four-way controller (▲▼◀▶) to choose an icon and pressing the **OK** button.

















Closes the Playback Mode Palette and goes to  mode.

Goes to the screen for selected playback function.



- When the frame is placed over each icon of the Playback Mode Palette, a guide for each function appears after about 2 seconds.
- You can turn off the guide for each function on the Playback Mode Palette. (p.177)

Playback Mode Palette

Item		Description	Page	
	Digital SR	For reducing the camera shake in recorded images	p.122	
	Slideshow	For playing back recorded images one after another	p.123	
	Resize	For changing the recorded pixels and quality of images	p.136	
	Cropping	Creates an image from a selected portion of the image	p.138	
	Image/Sound Copy	For copying images and sound files from the built-in memory to the SD Memory Card and vice versa	p.139	
	Image Rotation	For rotating still pictures	p.43	
	Digital Filter	For processing still pictures as you desire	p.141	
	Movie Edit	Save as Still image	For saving one frame from a movie as a still picture	p.147
	Divide Movies	Divide Movies	For dividing a movie into two	p.148
	Frame Composite	For adding a decorative frame to a still picture	p.145	
	Red-eye Compensation	For correcting still pictures where the flash has caused the subject to appear with red eyes	p.144	
	Voice Memo	For adding a voice memo to still pictures	p.160	
	Protect	For protecting images and sound files from accidental deletion	p.134	
	DPOF	For setting the DPOF print order data for still pictures	p.149	
	Image Recovery	For recovering deleted images	p.133	
	Start-up Screen	For setting the start-up screen	p.179	

Taking Pictures

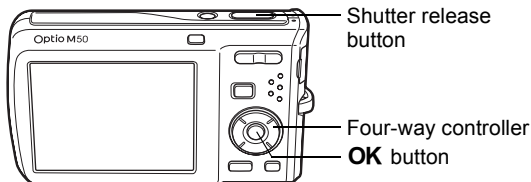

Taking Pictures Automatically (Auto Picture Mode)

In **AUTO PICT** (Auto Picture) mode, when you press the shutter release button, the camera selects the most appropriate mode from six shooting modes: 😊 (Standard), 🌃 (Night Scene), 🏞️ (Landscape), 👤 (Portrait), 🏃 (Sport) and 🌸 (Flower) modes.

- 1 Press the four-way controller (▼) in 📷 mode.**
The Capture Mode Palette appears.
- 2 Use the four-way controller (▲▼◀▶) to select **AUTO PICT** (Auto Picture).**
- 3 Press the OK button.**
- 4 Press the shutter release button halfway.**
The focus frame on the display turns green when the subject is in focus, and the icon for selected shooting mode will appear on the top left of the display.
- 5 Press the shutter release button fully.**
The picture is taken.



In **AUTO PICT** mode, the exposure compensation is not available. (📖 p.84)

Taking Still Pictures 📖p.40

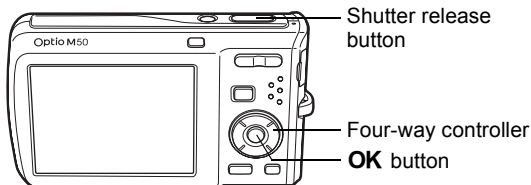

Setting The Functions (Program Mode)

In **P** (Program) mode, the camera automatically sets the shutter speed and aperture for taking still pictures. However, you can select other functions such as the flash mode and recorded pixels.

- 1 Press the four-way controller (▼) in **P** mode.**
The Capture Mode Palette appears.
- 2 Use the four-way controller (▲▼◀▶) to select **P** (Program).**
- 3 Press the OK button.**
- 4 Set the functions you want to use.**
Refer to "Setting the Shooting Functions" (p.87 - p.105) for details of how to set the functions.
- 5 Press the shutter release button halfway.**
The focus frame on the display turns green if the subject is in focus.
- 6 Press the shutter release button fully.**
The picture is taken.



Taking Still Pictures p.40

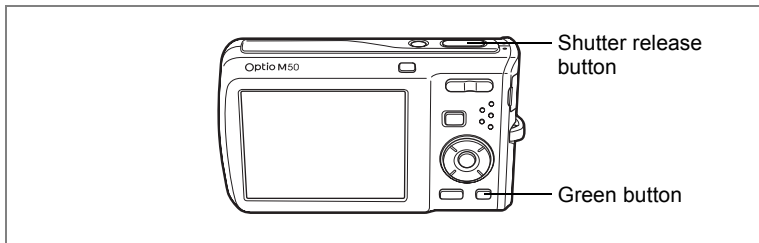

Taking Pictures in the Basic Mode (Green Mode)

In the **●** (Green) mode, you can enjoy easy picture-taking using standard settings*, regardless of the settings in the [📷 Rec.Mode] menu.

1 Press the Green button in 📷 mode.

The camera switches to **●** mode.

Press the Green button again to return to the status before **●** mode was selected.

2 Press the shutter release button halfway.

The focus frame on the display turns green if the subject is in focus.

3 Press the shutter release button fully.

The picture is taken.





- Assign mode to the Green button for using mode. (p.57)
- In mode, you cannot change the information on the display by pressing the **OK/DISPLAY** button.
- You cannot use the [Rec.Mode] menu or Capture Mode Palette in mode. If you try to display the [Rec.Mode] menu or Capture Mode Palette, (key lock icon) appears.
- If you switched to mode from mode, you cannot display the [Setting] menu by pressing the **MENU** button. If you try to display the [Setting] menu, (key lock icon) appears.
- When the camera is turned off in mode, it turns on in mode next time the power switch is pressed.



Key lock icon

4

* mode settings are as shown below.

Flash Mode	(Auto)
Drive Mode	<input type="checkbox"/> (Standard)
Focus Mode	AF (Standard)
Information Display	Normal
Recorded Pixels	
Quality Level	★★ (Better)
White Balance	AWB (Auto)
Focusing Area	[] (Multiple)
AE Metering	Multi-segment metering
Sensitivity	Auto
EV Compensation	±0.0
Digital Wide	<input type="checkbox"/> (Off)
Digital Zoom	<input checked="" type="checkbox"/> (On)
Instant Review	1sec
Sharpness	(Normal)
Saturation	(Normal)
Contrast	(Normal)
Date Imprint	<input type="checkbox"/> (Off)

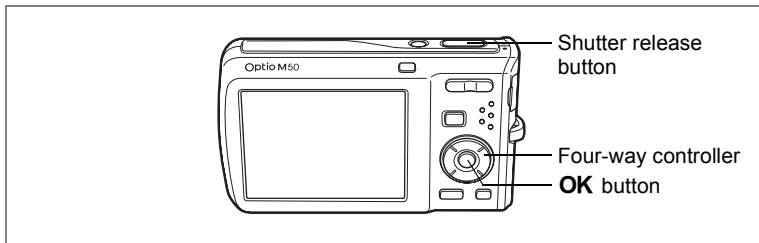

Taking Pictures of Dark Scenes (Night Scene/Digital SR (Blur Reduction) Mode)

You can choose settings appropriate for taking pictures of dark scenes, such as nightscapes.

	Use this mode when taking pictures of night views.
	Use this mode to take pictures indoors or in low light conditions.

- 1 Press the four-way controller (▼) in mode.**
The Capture Mode Palette appears.
- 2 Use the four-way controller (▲▼◀▶) to select (Night Scene) or (Digital SR (Blur Reduction)).**
- 3 Press the OK button.**
The shooting mode is selected and the camera returns to capture status.
- 4 Press the shutter release button halfway.**
The focus frame on the display turns green if the subject is in focus.
- 5 Press the shutter release button fully.**
The picture is taken.



- The shutter speed tends to be slower when taking pictures of a dark scene.
- To prevent camera shake, use a tripod and/or the self-timer function. (p.76)
- In mode, sensitivity is automatically set to Auto. (p.99)
- In mode, the number of recorded pixels is fixed at **5M** (2592 × 1944).

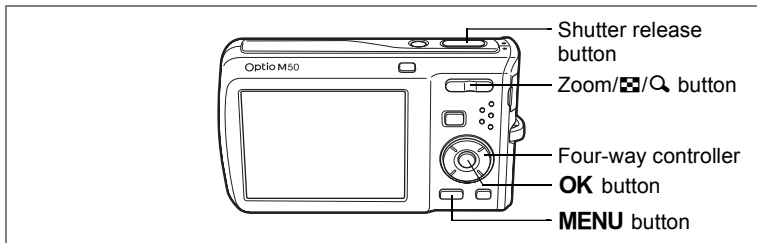

Framing Your Pictures (Frame Composite)

In (Frame Composite) mode, you can take pictures using the frames stored in the camera.

1 Press the four-way controller () in mode.

2 Use the four-way controller () to select (Frame Composite) and press the OK button.

A 9-frame display of the frame selection screen appears.

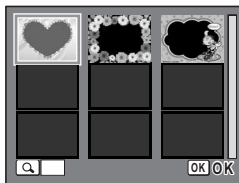

3 Use the four-way controller () to choose the frame you want to use.

4 Press on the Zoom//Q button.

The selected frame appears in single-image display. You can choose another frame using either of the following operations.

- Use the four-way controller () to choose a different frame.
- Press on the Zoom//Q button to return to the 9-frame display of the frame selection screen, and then perform Step 4 to choose a different frame.



5 Press the OK button.

The frame appears on the screen.

6 Press the shutter release button halfway.

The focus frame on the display turns green if the subject is in focus.

7 Press the shutter release button fully.

The picture is taken.



- In mode, recorded pixels is fixed at (2048 × 1536).
- In (Auto Picture), (Movie), (Voice Recording), (Digital Panorama) or (Digital Wide) mode, mode is not available.

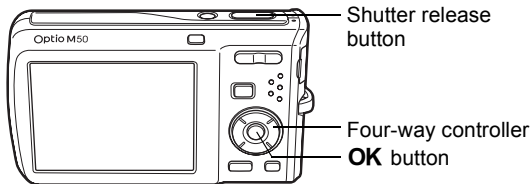

Taking Pictures of People (Natural Skin Tone/Portrait Mode)

4

Taking Pictures

(Natural Skin Tone) and (Portrait) modes are suitable for taking pictures of people. Face Recognition (p.56) operates for each shooting mode, making it easier to emphasize the subject's face when taking pictures.

	Use this mode when you want to enhance the natural skin tone of the people in your pictures.
	Use this mode when taking pictures of people.

1 Press the four-way controller (▼) in mode.

The Capture Mode Palette appears.

2 Use the four-way controller (▲▼◀▶) to select (Natural Skin Tone) and press the OK button.

Choose (Portrait) when is displayed instead of and press the OK button.

3 Use the four-way controller (▲▼) to choose or .

4 Press the OK button.

The shooting mode is selected and the camera returns to capture status.

When the subject's face is recognized, a yellow focus frame appears on the display at the location of the face (when multiple faces are recognized, the main face is indicated in yellow). As the subject moves, the size and location of the focus frame change to match the location of the subject's face.

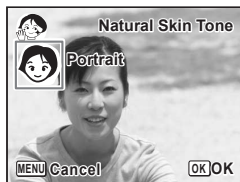

5 Press the shutter release button halfway.

The focus frame on the display turns green if the subject is in focus.

6 Press the shutter release button fully.

The picture is taken.



- If the camera cannot recognize the subject's face, the camera focuses using the Focusing Area currently selected.
- When Smile Capture is activated, the shutter will be released automatically when the camera recognizes the subject's smile. However, if the face detected by the camera is too small, an image may not be captured automatically because the Smile Capture function will not work.

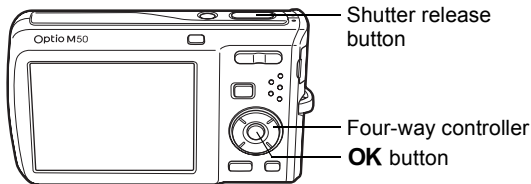

Taking Pictures of Your Pet (Pet Mode)

Use this mode to keep your moving pet in focus while you take the picture and capture the color of your pet's coat. Choose the appropriate icon depending on what color your pet is (closer to black or white or in between).

- 1 Press the four-way controller (▼) in mode.**
The Capture Mode Palette appears.
- 2 Use the four-way controller (▲▼◀▶) to select (Pet).**

- 3 Press the OK button.**

The Pet mode selection screen appears.

- 4 Use the four-way controller (▲▼) to select , , , , , or .**

There are two types of icons: a cat and dog icon.

(Choosing either the cat or dog icon does not affect the resulting picture. Choose whichever you prefer.)

Choose an icon (white, gray, or black) whose tone best matches your pet's coat or fur.



- 5 Press the OK button.**

The Pet mode is selected and the camera returns to capture status.

- 6 Press the shutter release button halfway.**

The focus frame on the display turns green if the subject is in focus.

The focus frame follows the pet while the shutter release button is pressed halfway.



7 Press the shutter release button fully.

The picture is taken.

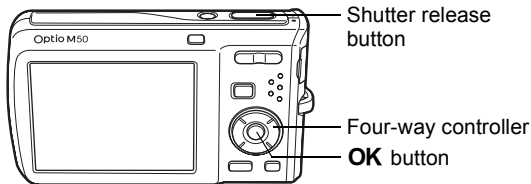

Taking Pictures of Children (Kids Mode)

☺ (Kids) mode is suitable for taking pictures of moving children. It also reproduces healthy and bright skin tone. Face Recognition (p.56) operates automatically for this mode, making it easier to emphasize the subject's face when taking pictures.

- 1 Press the four-way controller (▼) in  mode.**
The Capture Mode Palette appears.
- 2 Use the four-way controller (▲▼◀▶) to select ☺ (Kids).**
- 3 Press the OK button.**

When the subject's face is recognized, a yellow focus frame appears on the display at the location of the face (when multiple faces are recognized, the main face is indicated in yellow). As the subject moves, the size and location of the focus frame change to match the location of the subject's face.



- 4 Press the shutter release button halfway.**
The focus frame on the display turns green if the subject is in focus.
- 5 Press the shutter release button fully.**
The picture is taken.



- Face Recognition AF and AE may not work if the subject is wearing sunglasses or has part of the face covered or if the subject is not looking toward the camera.
- If the camera cannot recognize the subject's face, the camera focuses using the Focusing Area currently selected.
- When Smile Capture is activated, the shutter will be released automatically when the camera recognizes the subject's smile. However, if the face detected by the camera is too small, an image may not be captured automatically because the Smile Capture function will not work.

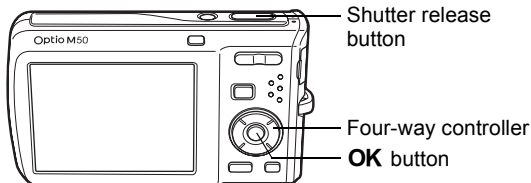

Taking Panoramic Pictures (Digital Panorama Mode)

4

Taking Pictures

The (Digital Panorama) mode enables you to overlap the edges of the frames so that they are easier to join together later into a panoramic picture. Take three frames overlapping their edges by moving the camera horizontally. When the third frame is taken, the images taken with the camera are automatically stitched and the panoramic photograph is saved.

- 1 **Press the four-way controller (▼) in mode.**
The Capture Mode Palette appears.
- 2 **Use the four-way controller (▲▼◀▶) to select (Digital Panorama).**
- 3 **Press the OK button.**
- 4 **Use the four-way controller (◀▶) to choose the direction in which the images will be joined.**



- 5 **Take the first frame.**
Press the shutter release button fully to take the first frame. The right or left edge of the first frame appears in semi-transparent form on the left or right of the display.
The position where the edge of the first frame appears depends on the direction chosen in the Step 4.



6 Move the camera horizontally to the right or left and take the second frame.

Move the camera so that the semi-transparent image and the actual view overlap and press the shutter release button. Repeat Steps 5 and 6 to take the third frame.

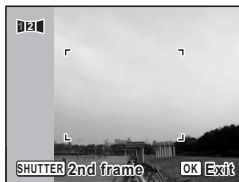

7 The panorama stitching starts when the third frame is taken and the stitched image appears.

The stitched image does not appear when the Instant Review (p.41, p.101) is off.



- When the Face Recognition is activated (p.56), it works only when taking the first image.
- If you press the **OK** button after shooting the first or second frame, you can save the captured image(s). (If you press the OK button after shooting the second frame, you can save the first and the second frames as a stitched image.)

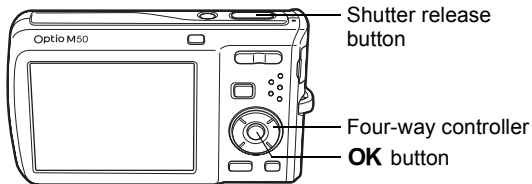

Using the Self-timer

In Self-timer mode, the picture is taken ten seconds or two seconds after the shutter release button is pressed.

Stabilize the camera with a tripod when taking a picture with the self-timer.

	Use this mode when you want to be included in a group picture. The picture is taken approximately ten seconds after the shutter release button is pressed.
	Use this mode to avoid camera shake. The picture is taken approximately two seconds after the shutter release button is pressed.

1 Press the four-way controller (▲) in mode.

2 Use the four-way controller (◀▶▼) to select or and press the OK button.

The camera is ready to take the picture using the self-timer.

3 Press the shutter release button halfway.

The focus frame on the display turns green if the subject is in focus.

4 Press the shutter release button fully.

The picture is taken ten seconds or two seconds later.



Focusing may be compromised if you move the camera while the self-timer lamp is blinking when taking still pictures.



- In (Movie) mode, recording will start after ten seconds (or two seconds).
- Press the shutter release button halfway while the self-timer is engaged to stop the countdown and press fully to restart the countdown.
- cannot be selected while (Green) mode is in default setting. Select in another shooting mode and then switch the shooting mode to .

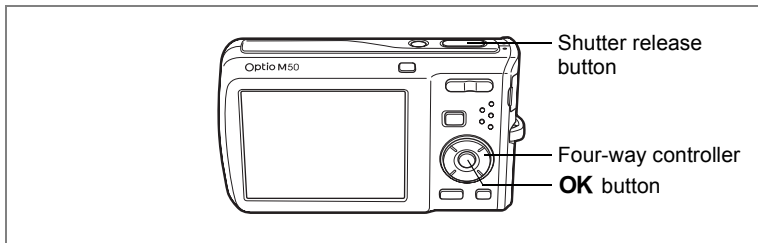

Taking a Series of Pictures (Continuous Shooting Mode)

In this mode, pictures are taken continuously as long as the shutter release button is pressed.

	Continuous Shooting	Each time a picture is taken, the image is saved in the memory before the next image is taken. The higher the image quality, the longer the interval between shots.
--	---------------------	---

1 Press the four-way controller (▲) in mode.

2 Use the four-way controller (◀▶) to select (Continuous Shooting) and press the OK button.

The camera is ready to take a series of pictures.

3 Press the shutter release button halfway.

The focus frame on the display turns green if the subject is in focus.

4 Press the shutter release button fully.

Pictures are taken continuously as long as you keep the shutter release button pressed.



- The flash does not discharge in Continuous Shooting.
- (Continuous Shooting) can not be chosen in (Auto Picture), (Night), (Movie), (Voice Recording), (Digital Panorama) or (Digital Wide) mode.



- You can continue shooting until the memory capacity of the SD Memory Card or built-in memory is full.
- The interval of Continuous Shooting varies according to the Recorded Pixels and Quality Level settings.
- The focus, exposure and white balance are locked with the first image.
- When the Face Recognition is activated (p.56), it works only when taking the first image.

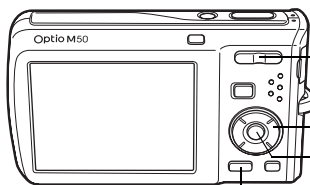

Zoom/AAA/A button

Four-way controller

OK button

MENU button

Using the Zoom

You can use the zoom to change the captured area.

4

1 Press the Zoom/AAA/A button in mode.

Zoom button (AAA) : Diminishes the subject (Wide).

Zoom button (A) : enlarges the subject. When you press and hold the button, the camera automatically switches from optical zoom to intelligent zoom. Once the button is released and pressed again, the camera switches to Digital Zoom.

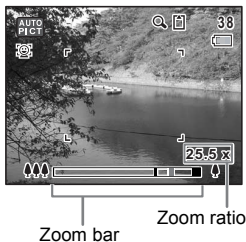

Zoom bar

Zoom ratio

The zoom bar is displayed as follow.

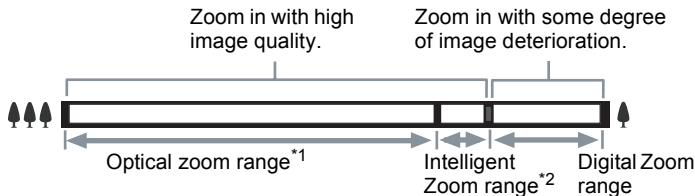

*1 You can zoom in to a maximum of 5x optically.

*2 The Intelligent Zoom range differs depending on the recorded pixels. See the following table.

Recorded pixels and the maximum zoom ratio

Recorded pixels	Intelligent Zoom	Digital Zoom
8M	Not Available (5× optical zoom available)	Equivalent to approx. 25.5×
5M	Approx. 6.3×	
4M	Approx. 7.1×	
3M	Approx. 8.0×	
2M	Approx. 10.2×	
1024	Approx. 15.9×	
640	Approx. 25.5× (Same as 25.5× Digital Zoom)	



- You are recommended to use a tripod to prevent camera shake when taking pictures at a high magnification rate.
- Pictures taken in the digital zoom range appear grainier than pictures taken in the optical zoom range.
- Intelligent Zoom is not available under the following conditions.
 - When Digital Zoom is set to Off.
 - When the recorded pixels is set to **8M**. (5× optical zoom available)
 - In (Movie) mode
 - In (Digital SR) mode
 - When the sensitivity is set to 3200 or 6400.
- The image enlarged using Intelligent Zoom may appear rough on the display. This does not affect the quality of recorded image.
- In mode, only Digital Zoom is available.

Setting the Digital Zoom

The digital zoom is set to (On) in the default settings. To take pictures using only the optical zoom, set the digital zoom to (Off).

1 Press the MENU button in  mode.

The [ Rec.Mode] menu appears.

2 Use the four-way controller (▲▼) to select [Digital Zoom].

3 Use the four-way controller (◀▶) to select (On) or (Off).

The selected setting is saved.

4 Press the MENU button.

The setting is complete and the camera returns to capture status.

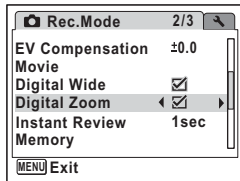

Saving the Digital Zoom Function Setting  p.106

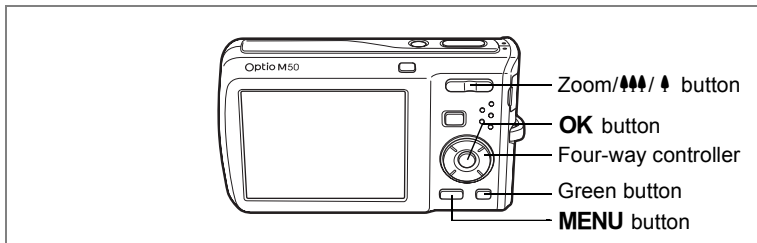

Using the Digital Wide Function (Digital Wide Mode)

■ (Digital Wide) mode can stitch two pictures taken into a 35 mm film conversion equivalent to a maximum of approx. 28 mm.

- 1 Press the ▲▲▲ side of the Zoom/▲▲▲/▲ button when in mode.**

Press and hold the ▲▲▲ side of the Zoom/▲▲▲/▲ button to set the zoom to the widest position, release the button, and then press it again.

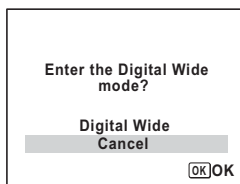

- 2 Press the four-way controller (▲).**
- 3 Press the OK button.**

The camera enters the mode and an explanation is displayed in the center of the screen.

After 5 seconds or when you press the Green button, the camera returns to capture status.

Turn the camera 90° counterclockwise and align your first picture.

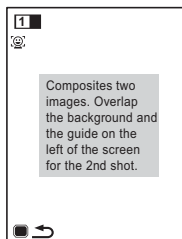

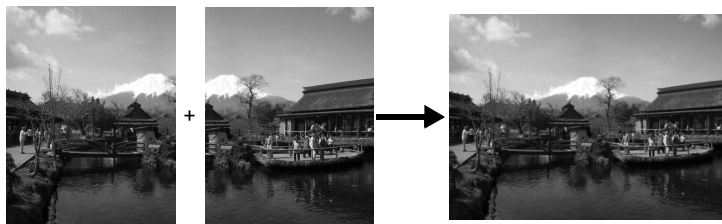

4 Press the shutter release button.

The first captured image is saved, and the shooting screen for the second image is displayed. Overlap the image on the preview guide on the left of the screen to compose your picture.

If you want to stop capturing images in the  mode, go to step 6.

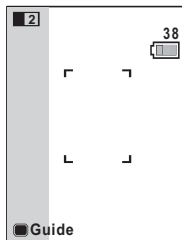

5 Press the shutter release button.

The combined first image and second image appear on the display for one second (Instant Review), and then saved to the built-in memory or SD Memory Card.



- For less distortion when taking the second picture, turn the camera to overlap the background and the preview guide on the left of the screen.
- Some distortion may result from moving objects, repeating patterns, or if nothing exists when overlapping the first and second picture on the preview guide.
- When the Face Recognition is activated (p.56), it works only when taking the first image.
- The number of recorded pixels for images captured with  mode is fixed at **5M**.

- 6 Press the **MENU** button, **OK** button, or **Zoom/** **button.**
 - 7 Press the four-way controller (**▲**).
 - 8 Press the **OK** button.
- mode stops.

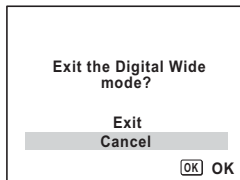

Setting the Digital Wide Function

mode is set to (On) in the default settings. Use the mode to set whether the camera enters mode when the side of the **Zoom/** **button** is pressed.

- 1 Press the **MENU** button in mode.
[Rec.Mode] appears.
- 2 Press the four-way controller (**▲ ▼**) to select [**Digital Wide**].
- 3 Use the four-way controller (**◀ ▶**) to select (On) or (Off).
- 4 Press the **MENU** button.

The selected setting is saved.

The setting is complete and the camera returns to capture status.

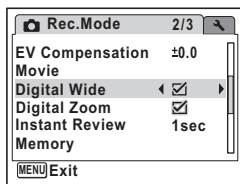

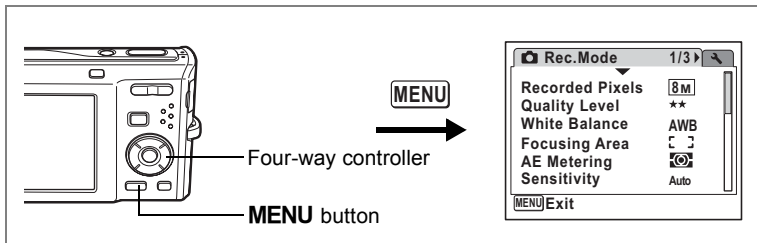

Setting the Exposure (EV Compensation)

You can adjust the overall brightness of the picture.

Use this function to take pictures that are intentionally overexposed or underexposed.

1 Press the MENU button in mode.

The [Rec.Mode] menu appears.

2 Use the four-way controller () to select [EV Compensation].

3 Use the four-way controller () to select the EV value.

The selected EV value is saved.

To brighten, select a positive (+) value. To darken, select a negative (-) value.

You can choose the EV setting in the range of -2.0 EV to +2.0 EV in 1/3 EV steps.

4 Press the MENU button.

The setting is complete and the camera returns to capture status.

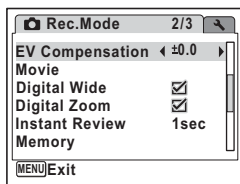

- If you use the EV compensation function frequently, you can save time by assigning it to the Green button. (p.58)
- When the histogram is displayed, bright portions and dark portions are indicated on the display, enabling you to check the exposure. (p.86)
- The EV compensation function cannot be used in (Auto Picture) or (Green) mode.

Saving the EV Compensation Value p.106

Displaying Shooting Information in Capture Mode

The display changes in the following sequence each time you press the **OK/DISPLAY** button: Normal Display, Histogram + Info, No Info. For details of each display mode, refer to “Monitor Indications” (p.18).



- appears if you press the shutter release button halfway when camera shake is likely to occur. To prevent camera shake, use a tripod and/or the self-timer function. (p.76)
- In (Green) mode, you cannot change the information on the display by pressing the **OK/DISPLAY** button.

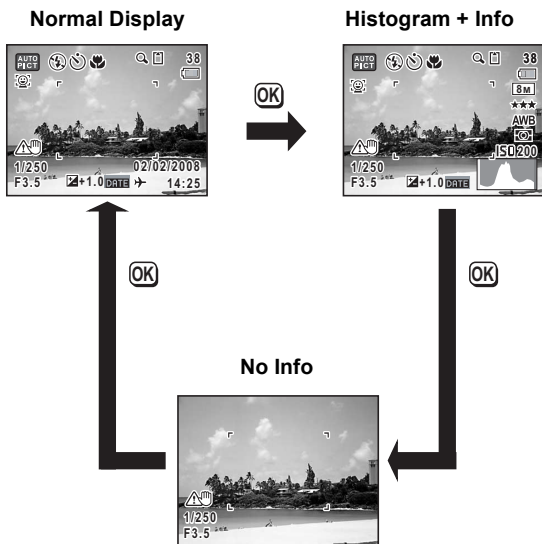

Using the Histogram

A histogram shows the brightness distribution of an image. The horizontal axis represents brightness (dark at the left and bright at the right) and the vertical axis represents the number of pixels.

The shape of the histogram before and after shooting tells you whether the brightness and contrast are correct or not, and lets you decide if you need to use EV compensation and take the picture again.

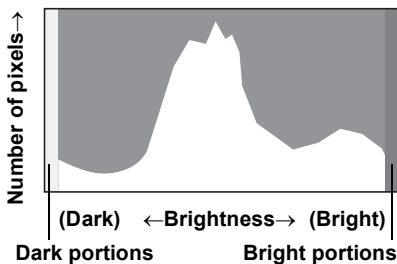

Setting the Exposure (EV Compensation) p.84

Understanding Brightness

If the brightness is correct, the graph peaks in the middle. If the image is too dark, the peak is on the left side, and if it is too bright, the peak is on the right side.

Dark image



Correct image

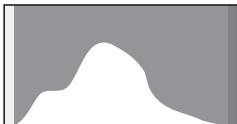

Bright image

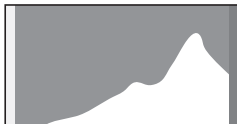

When the image is too dark, the part to the left is cut off (dark portions) and when the image is too bright, the part to the right is cut off (bright portions).

Bright portions blink red on the display and dark portions blink yellow.

Displaying Shooting Information in Capture Mode p.85

Displaying Shooting Information in Playback Mode p.121

Understanding Contrast

The graph peaks gradually for images in which contrast is balanced. The graph peaks on both sides but sinks in the middle for images with a large difference in contrast and low amounts of mid-level brightness.



Setting the Shooting Functions



Four-way controller
OK button

Selecting the Focus Mode

Focus Mode

AF	Standard	Use this mode when the distance to the subject is 40 cm (16 in.) or more. The camera is focused on the subject in the autofocus area when the shutter release button is pressed halfway.
	Macro	This mode is used when the distance to the subject is approx. 10 cm to 50 cm (4 in. to 24 in.). The camera is focused on the subject in the autofocus area when the shutter release button is pressed halfway.
PF	Pan Focus	This mode is used when you ask someone to take pictures for you, or when taking pictures of the scenery through the window of a car or train. The entire picture, from the front to the back, is focused.
	Infinity	This mode is used for taking distant objects. The flash is set to  (Flash Off).
MF	Manual Focus	This mode lets you adjust the focus manually.

1 Press the four-way controller (▶) in mode.

The focus mode changes each time the button is pressed. You can also change the setting using the four-way controller (▲▼).

2 Press the shutter release button halfway.

The Focus Mode setting is saved and the camera returns to capture status.

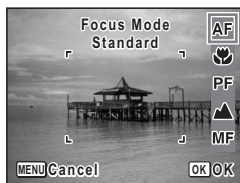



- In **AF** (Green) mode, you can only select **AF**, or **PF**.
- When shooting with **AF** selected, if the subject is closer than 40 cm, the camera automatically focuses from 10 cm.
- When shooting with selected, if the subject is further than 50 cm away, the camera automatically focuses to infinity.

Saving the Focus Mode p.106

Manual Focus

The procedure for setting the focus manually (**MF**) is described below.

1 Press the four-way controller (▶) in mode.

2 Use the four-way controller (▶) to select MF and press the OK button.

The central portion of the image is magnified to fill the screen of the display when focusing.

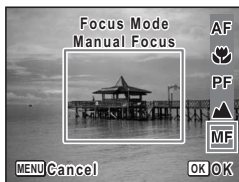

3 Press the four-way controller (▲▼).

The **MF** indicator appears on the display to indicate the approximate distance to the subject. Use the four-way controller (▲▼) to adjust the focus using the indicator as a guide.

▲ : for distant focus

▼ : for closer focus

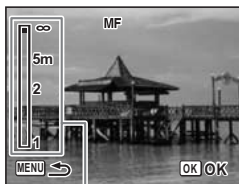

MF indicator

4 Press the OK button.

The focus is fixed and the camera returns to capture status.

In addition, the focus position is fixed five seconds after you remove your finger from the four-way controller (▶).

After the focus is fixed, you can press the four-way controller (▶) again to display the **MF** bar and readjust the focus.



To switch from **MF** to another focus mode, press the four-way controller (▶) while the **MF** bar is displayed.



Capture mode and drive mode cannot be changed while the **MF** bar is displayed.

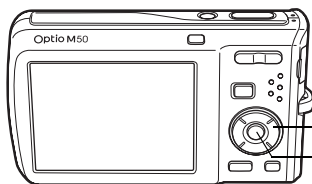

Four-way controller

OK button

Selecting the Flash Mode

Flash Modes

	Auto	The flash discharges automatically depending on the light conditions.
	Flash Off	The flash does not discharge, regardless of the brightness. Use this mode to take pictures where flash photography is prohibited.
	Flash On	The flash discharges regardless of the brightness.
	Auto + Red-eye	This mode reduces the phenomenon of red eyes caused by the light from the flash being reflected in the subject's eyes. The flash discharges automatically.
	Flash On + Red-eye	This mode reduces the phenomenon of red eyes caused by the light from the flash being reflected in the subject's eyes. The flash discharges regardless of the light conditions.
	Soft Flash	This mode reduces the intensity of the flash so that the flash is not too bright even when fired at close range. The flash discharges regardless of the light conditions.



- The flash does not discharge (Flash Off) in (Movie) or (Digital Panorama) mode, or when the drive mode is set to or the focus mode is set to .
- A pre-flash discharges when using the red-eye reduction function.
- In (Green) mode, you can only select or .
- In (Night) mode, you cannot select and .



Using the flash when capturing images at a close distance may cause irregularities in the image due to the light distribution.

1 Press the four-way controller (◀) in mode.



The flash mode changes each time the button is pressed. You can also change the setting using the four-way controller (▲▼).

2 Press the OK button.

The camera returns to capture status with the selected flash mode.



[About the red-eye phenomenon]

Taking pictures using the flash may cause the subject's eyes to appear red in the resulting picture. This phenomenon occurs when the light from the flash is reflected in the subject's eyes. It can be reduced by illuminating the area around the subject or moving closer to the subject and zooming out to a wider angle. Setting the flash mode to  (Auto + Red-eye) or  (Flash On + Red-eye) is also an effective way of reducing red eyes.

If the subject's eyes appear red despite such precautions, they can be corrected by the red-eye compensation function (p.144).

Saving the Flash Mode  p.106

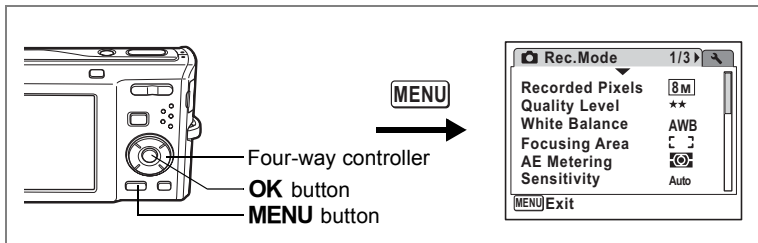

Selecting the Recorded Pixels

You can choose from seven recorded pixels settings for still pictures. The larger your recorded pixels, the clearer the details will appear when you print your picture. As the quality of the printed picture also depends on the image quality, exposure control, resolution of the printer and other factors, you do not need to select more than the required number of recorded pixels. [2M] (1600×1200) is adequate for making postcard-size prints. The more pixels there are, the larger the picture and the bigger the file size. The data volume also varies depending on the quality level setting (p.93).

Recorded Pixels

Recorded Pixels	Use
[8M] 3264×2448	For printing high quality photos or A4-size pictures or larger, or editing images on a PC.
[5M] 2592×1944	
[4M] 2304×1728	For making postcard-size prints.
[3M] 2048×1536	
[2M] 1600×1200	For posting on a website or attaching to e-mail.
[1024] 1024× 768	
[640] 640× 480	

- 1 Press the MENU button in mode.**
The [Rec.Mode] menu appears.
- 2 Use the four-way controller (▲▼) to select [Recorded Pixels].**

3 Press the four-way controller (▶).

A pull-down menu appears.

4 Use the four-way controller (▲▼) to change the number of recorded pixels.

5 Press the OK button.

The Recorded Pixels setting is saved.

6 Press the MENU button.

The camera returns to capture status with the current setting.

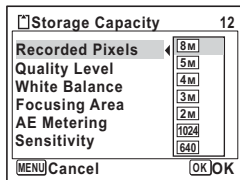

- When drive mode is set to (Frame Composite), the number of recorded pixels is fixed at **3M**.
- The number of recorded pixels for images captured in (Digital Wide) or (Digital SR) mode is fixed at **5M**. (However, the number of recorded pixels will be **3M** if you exit the Digital Wide mode without taking second picture.)
- If you take and save only the first frame in (Digital Panorama) mode, the number of recorded pixels fixed at **2M**.
- If you use the [Recorded Pixels] function frequently, you can save time by assigning it to the Green button. (p.58)

Recorded Pixels and Quality Level of Still Pictures p.31

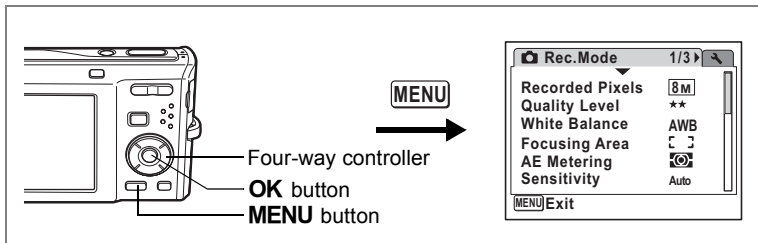

Selecting the Quality Level

You can select the quality (compression rate) of still pictures. The more stars, the lower the compression rate and the clearer the picture, but the file size becomes larger. The recorded pixels setting also affects the file size (p.91).

Quality Level

★★★	Best	Lowest compression rate. Suitable for photo prints.
★★	Better	Standard compression rate. Suitable for viewing the image on a computer screen.
★	Good	Highest compression rate. Suitable for posting on a website or attaching to e-mail.

- 1 Press the MENU button in mode.**
The [Rec.Mode] menu appears.
- 2 Use the four-way controller (▲▼) to select [Quality Level].**
- 3 Press the four-way controller (▶).**
A pull-down menu appears.
- 4 Use the four-way controller (▲▼) to change the quality level.**
- 5 Press the OK button.**
The Quality Level setting is saved.
- 6 Press the MENU button.**
The camera returns to capture status with the current setting.

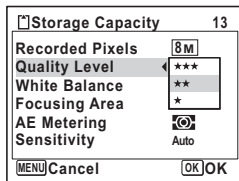

If you use the [Quality Level] function frequently, you can save time by assigning it to the Green button. (p.58)

Recorded Pixels and Quality Level of Still Pictures p.31

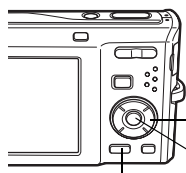

Four-way controller
OK button
MENU button

MENU

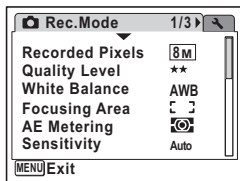

Adjusting the White Balance

You can take pictures in natural colors by adjusting the white balance according to the light conditions at the time of shooting.

White Balance

AWB	Auto	The camera adjusts the white balance automatically.
	Daylight	Use this mode when taking pictures outside in sunlight.
	Shade	Use this mode when taking pictures outside in the shade.
	Tungsten Light	Use this mode when taking pictures under electric or other tungsten light.
	Fluores. Light	Use this mode when taking pictures under fluorescent light.
	Manual	Use this mode when adjusting the white balance manually.



Set another white balance if you are not satisfied with the color balance of pictures taken with white balance set to AWB (Auto).

- 1 Press the MENU button in mode.**
The [Rec.Mode] menu appears.
- 2 Use the four-way controller () to select [White Balance].**
- 3 Press the four-way controller () .**
The White Balance screen appears.
- 4 Use the four-way controller () to change the setting.**

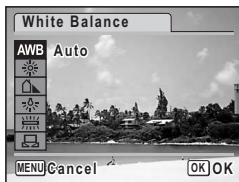

5 Press the **OK** button.

The White Balance setting is saved.

6 Press the **MENU** button.

The camera returns to capture status with the current setting. Refer to “Manual Setting” below for instructions on adjusting the white balance manually.



If you use the [White Balance] function frequently, you can save time by assigning it to the Green button. (p.58)

Saving the White Balance p.106

Manual Setting

Have a blank sheet of white paper or similar material ready.

1 In the White balance screen, use the four-way controller (▲▼) to select (Manual).

2 Point the camera at the blank sheet of paper or other material so that it fills the frame displayed in the center of the screen.

3 Press the shutter release button fully.

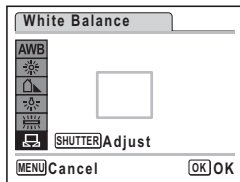

The white balance is automatically adjusted.

4 Press the **OK** button.

The setting is saved and the screen returns to the [Rec.Mode].

5 Press the **MENU** button.

The camera returns to capture status.

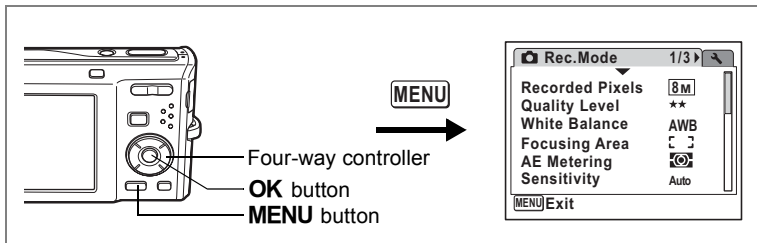

Setting the AE Metering

You can set the area of the screen where the brightness is metered to determine the exposure.

AE metering

	Multi-segment metering	The camera divides the image into 256 areas, meters the brightness and determines the exposure.
	Center-weighted metering	The camera takes a reading of the overall brightness of the picture with the center of the image having more influence on the exposure.
	Spot AE metering	The camera determines the exposure by metering the brightness only at the center of the image.

- 1 Press the MENU button in mode.**
The [Rec.Mode] menu appears.
- 2 Use the four-way controller () to select [AE Metering].**
- 3 Press the four-way controller ().**
A pull-down menu appears.
- 4 Use the four-way controller () to select the AE Metering setting.**
- 5 Press the OK button.**
The AE Metering setting is saved.
- 6 Press the MENU button.**
The camera returns to capture status with the current setting.

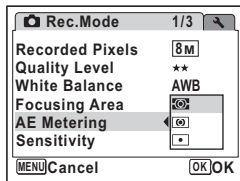



- When the shutter release button is pressed halfway, the brightness is metered and the exposure is determined.
- When the subject is outside the focusing area and you want to use spot AE metering, aim the camera at the subject and press the shutter release button halfway to lock the exposure, then compose your picture again and press the shutter release button fully.
- If you use the [AE Metering] function frequently, you can save time by assigning it to the Green button. (p.58)

Saving the AE Metering  p.106

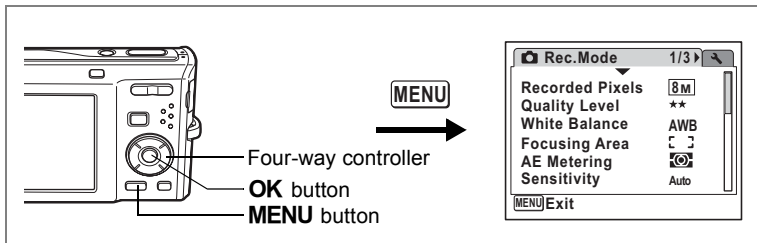

Setting the Sensitivity

You can select the sensitivity to suit the brightness of the surroundings.

4

Sensitivity

Auto	The sensitivity is automatically adjusted by the camera. (sensitivity 64 - 800)
64	<ul style="list-style-type: none"> The lower the sensitivity, the less noise that affects the image. The shutter speed will be slower in low light conditions. Higher sensitivity settings use faster shutter speeds in low light conditions to reduce camera shake, but the image may be affected by noise.
100	
200	
400	
800	
1600	
3200	
6400	

- 1 Press the MENU button in mode.**
The [Rec.Mode] menu appears.
- 2 Use the four-way controller () to select [Sensitivity].**
- 3 Press the four-way controller ().**
A pull-down menu appears.
- 4 Use the four-way controller () to change the sensitivity.**
- 5 Press the OK button.**
The sensitivity setting is saved.
- 6 Press the MENU button.**
The camera returns to capture status with the current setting.

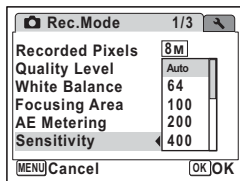



- When Sensitivity is set to 3200 or 6400, the number of recorded pixels fixed at **5M**.
- When the shooting mode is set to (Movie), only Auto (sensitivity 64 - 800) is available.
- When the shooting mode is set to (Digital SR), only Auto (sensitivity 64 - 6400) is available.
- If you use the [Sensitivity] function frequently, you can save time by assigning it to the Green button. (p.58)

Saving the sensitivity p.106

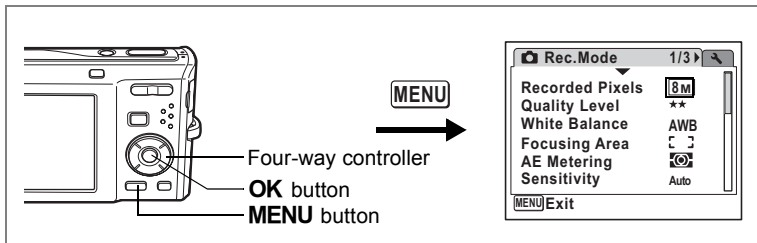

Setting the Autofocus Conditions

You can set various conditions for autofocus.

4

Setting the Focusing Area

You can change the autofocus area (Focusing Area).

Focusing Area

[]	Multiple	Normal autofocus area
[]	Spot	The autofocus area becomes smaller.
[]	Automatic Tracking AF	Keeps moving subjects in focus.

- 1 Press the MENU button in mode.**
The [Rec.Mode] menu appears.
- 2 Use the four-way controller (▲▼) to select [Focusing Area].**
- 3 Press the four-way controller (▶).**
A pull-down menu appears.
- 4 Use the four-way controller (▲▼) to change the Focusing setting.**
- 5 Press the OK button.**
The AF Setting is saved.
- 6 Press the MENU button.**
The camera returns to capture status with the current setting.

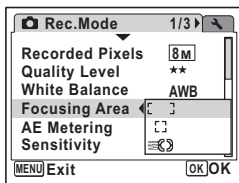

- In (Frame Composite) mode, [Focusing Area] can only be set to [] (Multiple) or [] (Spot).
- In (Auto Picture) mode, [Focusing Area] is fixed at [] (Multiple).
- If you use the [Focusing Area] function frequently, you can save time by assigning it to the Green button. (p.58)

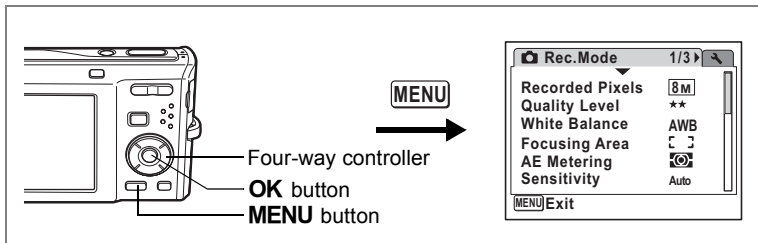

Setting the Instant Review Time (Instant Review)

You can choose the Instant Review time (the length of time the image is displayed immediately after capture) from 0.5sec, 1sec, 2sec, 3sec, 5sec and Off (no display).

1 Press the **MENU** button in **📷** mode.

The [📷 Rec.Mode] menu appears.

2 Use the four-way controller (▲▼) to select [Instant Review].

3 Press the four-way controller (▶).

A pull-down menu appears.

4 Use the four-way controller (▲▼) to change the display time.

5 Press the **OK** button.

The Instant Review setting is saved.

6 Press the **MENU** button.

The camera returns to capture status with the current setting.

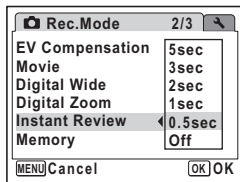

Instant Review p.41



If the Face Recognition function worked when shooting, Blinking Detection will operate during Instant Review (p.41).

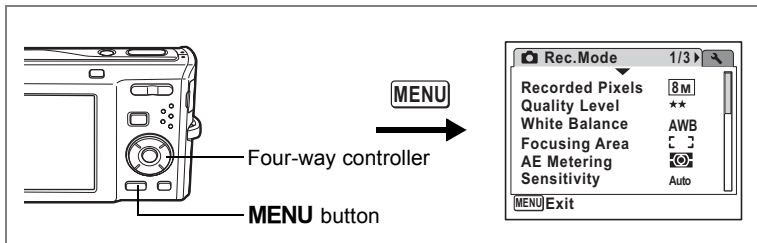

Setting the Image Sharpness (Sharpness)

You can give the image sharp or soft outlines.

4

Taking Pictures

1 Press the MENU button in mode.

The [Rec.Mode] menu appears.

2 Use the four-way controller (▲▼) to select [Sharpness].

3 Use the four-way controller (◀▶) to change the sharpness level.

The following setting is saved.

(Soft)

(Normal)

(Hard)

4 Press the MENU button.

The Sharpness setting is saved and the camera returns to capture status.

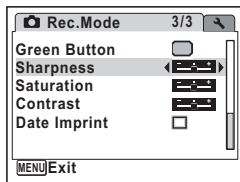

If you use the [Sharpness] function frequently, you can save time by assigning it to the Green button. (p.58)

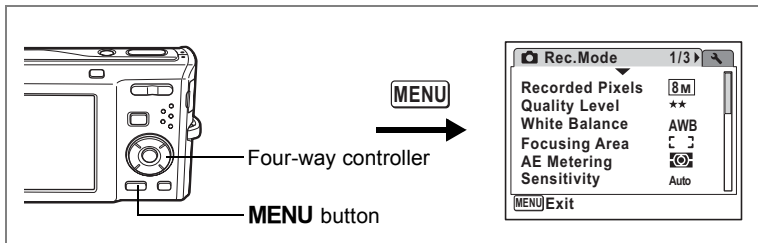

Setting the Color Saturation (Saturation)

You can set the color saturation.

- 1 Press the MENU button in mode.**
The [Rec.Mode] menu appears.
- 2 Use the four-way controller () to select [Saturation].**
- 3 Use the four-way controller () to change the saturation level.**

The following setting is saved.

- (Low)
- (Normal)
- (High)

- 4 Press the MENU button.**

The Saturation setting is saved and the camera returns to capture status.



If you use the [Saturation] function frequently, you can save time by assigning it to the Green button. (p.58)

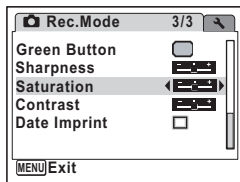

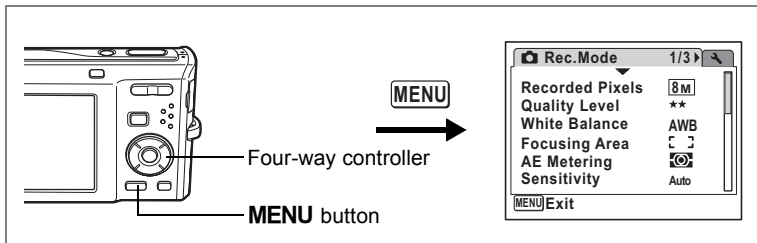

Setting the Image Contrast (Contrast)

You can set the image contrast level.

4

Taking Pictures

1 Press the **MENU** button in mode.

The [Rec.Mode] menu appears.

2 Use the four-way controller () to select [**Contrast**].

3 Use the four-way controller () to change the contrast level.

The following setting is saved.

(Low)

(Normal)

(High)

4 Press the **MENU** button.

The Contrast setting is saved and the camera returns to capture status.

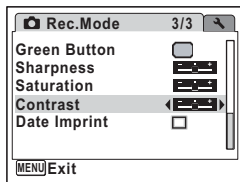

If you use the [Contrast] function frequently, you can save time by assigning it to the Green button. (p.58)

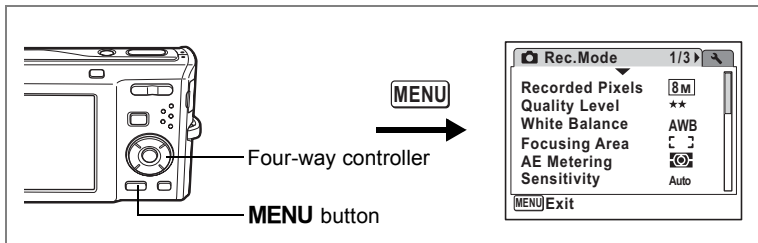

Setting the Date Imprint Function

For choosing whether to imprint the date when taking still pictures.

- 1 Press the MENU button in mode.**
The [Rec.Mode] appears.
- 2 Use the four-way controller (▲▼) to select [Date Imprint].**
- 3 Use the four-way controller (◀▶) to select (On) or (Off).**
The selected setting is saved.
- 4 Press the MENU button.**

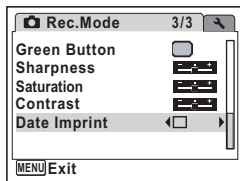













The date imprinted with this function cannot be deleted.

Saving the Settings (Memory)

The Memory function is for saving the current camera settings when the camera is turned off.

For some camera settings, the Memory function is always set to (On) (the settings are saved when the camera is turned off), while for others you can choose on or off (to choose whether the settings are saved or not when the camera is turned off). The items which can be set to (On) or (Off) in the Memory function are shown in the table below. (Items not listed here are always saved in the selected settings when the camera is turned off.) If you select (On), the settings will be saved in the status they were in immediately before the camera was turned off. If you select (Off), the settings will be reset to the defaults when the camera is turned off. The table below also shows whether the Memory default setting for each item is on or off.

Item	Description	Default Setting
Face Priority	A Face Recognition mode set by using the  button.	<input type="checkbox"/>
Flash Mode	The flash mode set with the four-way controller () (p.89)	<input checked="" type="checkbox"/>
Drive Mode	The drive mode set with the four-way controller () (p.76, p.77)	<input type="checkbox"/>
Focus Mode	The focus mode set with the four-way controller () (p.87)	<input type="checkbox"/>
Zoom Position	The zoom position set with the Zoom/  /  button (p.78)	<input type="checkbox"/>
MF Position	The manual focus position set with the four-way controller ( ) (p.88)	<input type="checkbox"/>
White Balance	The [White Balance] setting on the [ Rec.Mode] menu (p.94)	<input type="checkbox"/>
Sensitivity	The [Sensitivity] setting on the [ Rec.Mode] menu (p.98)	<input type="checkbox"/>
EV Compensation	The [EV Compensation] setting on the [ Rec.Mode] menu (p.84)	<input type="checkbox"/>
AE Metering	The [AE Metering] setting on the [ Rec.Mode] menu (p.96)	<input type="checkbox"/>
Digital Zoom	The [Digital Zoom] setting on the [ Rec.Mode] menu (p.80)	<input checked="" type="checkbox"/>
DISPLAY	The display information display mode set with the OK/ DISPLAY button (p.85, p.121)	<input type="checkbox"/>
File No.	If a new SD Memory Card is inserted when On has been selected, file numbers are assigned sequentially.	<input checked="" type="checkbox"/>

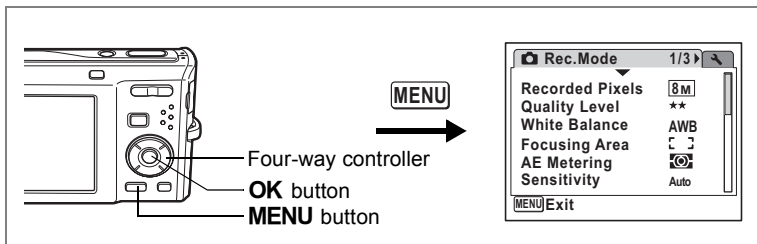

- 1 Press the MENU button in mode.**
The [Rec.Mode] menu appears.
- 2 Press the four-way controller () to select [Memory].**
- 3 Press the four-way controller ().**
The Memory screen appears.
- 4 Use the four-way controller () to choose an item.**
- 5 Use the four-way controller () to select (On) or (Off).**
- 6 Press the OK button.**
The Memory setting is saved.
- 7 Press the MENU button.**
The camera returns to capture status with the current setting.

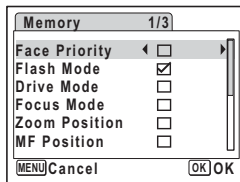

Recording Movies

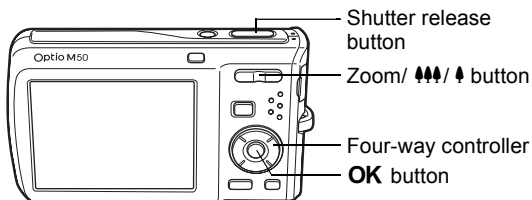

4

Recording a Movie

This mode enables you to record movies. Sound is recorded at the same time.

1 Press the four-way controller (▼) in mode.

The Capture Mode Palette appears.

2 Use the four-way controller (▲▼◀▶) to select (Movie).

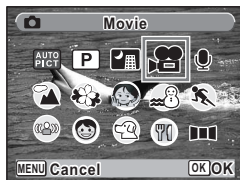

3 Press the OK button.

(Movie) mode is selected and the camera returns to capture status. The following information appears on the display.

- 1 Movie mode icon
- 2 Recording indicator (blinks during recording)
- 3 Remaining recordable time
- 4 Focus frame (does not appear during recording)
- 5 Movie shake reduction function icon

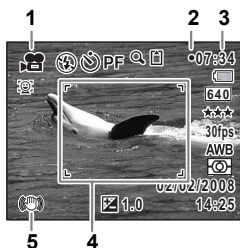

You can change the captured area by pressing the Zoom/ button to the left or right.

▲ : enlarges the subject

▶▶▶ : widens the area that is captured by the camera

4 Press the shutter release button fully.

Recording starts. Recording can continue until the built-in memory/SD Memory Card is full, or the size of the recorded movie reaches 2 GB.



- The flash does not discharge in mode.
- The focus mode can be changed before recording starts.
- When the Focus Mode is set to **MF** (Manual Focus), you can adjust the focus before recording starts.
- You can use the optical zoom only before recording, while the digital zoom is available both before and during recording.
- Changing the display mode by pressing the **OK/DISPLAY** button while recording a movie will not display the histogram.
- When the shooting mode is set to , Face Priority is automatically set to on. You can select Smile Capture On or Face Priority Off by pressing the button before starting recording a movie. (p.56) When Smile Capture is activated, movie recording starts automatically when the camera recognizes the subject's smile. However, if the face detected by the camera is too small, movie recording may not start automatically because the Smile Capture function will not work.

5 Press the shutter release button fully.

Recording stops.

Playing Back Movies p.125

Keeping the Shutter Release Button Pressed

If you keep the shutter release button pressed for more than one second, recording will continue as long as you keep the button pressed. Shooting stops when you take your finger off the shutter release button.

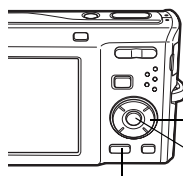

Four-way controller

OK button

MENU button

MENU

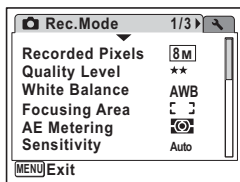

Selecting the Recorded Pixels for Movies

You can choose from two recorded pixels settings for movies: **640** and **320**.

The more pixels there are, the clearer the details and the bigger the file size. The file size also varies depending on the quality level and frame rate settings. (p.32)

Recorded Pixels for Movies

640 (640×480)	Suitable for viewing on a TV or computer screen.
320 (320×240)	Suitable for posting on a website or attaching to e-mail.

- 1 Press the MENU button in mode.**
The [Rec.Mode] menu appears.
- 2 Use the four-way controller (▲▼) to select [Movie].**
- 3 Press the four-way controller (▶).**
The Movie screen appears.
- 4 Use the four-way controller (▲▼) to select [Recorded Pixels].**
- 5 Press the four-way controller (▶).**
A pull-down menu appears.
- 6 Use the four-way controller (▲▼) to change the number of recorded pixels.**
- 7 Press the OK button.**
The Recorded Pixels setting is saved.
- 8 Press the MENU button twice.**
The camera returns to capture status with the current setting.

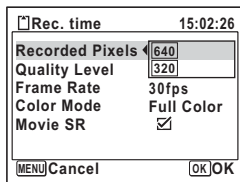

Recorded Pixels, Quality Level and Frame Rate of Movies p.32

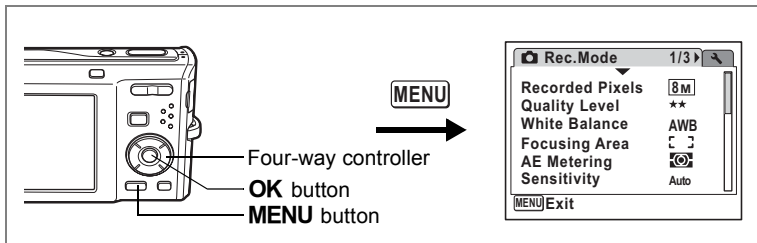

Selecting the Quality Level of Movies

You can set the quality level of movies. The higher the quality level, the clearer the details and the bigger the file size.

Quality level of movies

★★★	Best	↑ ↓	Clearer images with larger file size
★★	Better		
★	Good		Grainier images with smaller file size

- Press the MENU button in mode.**
The [Rec.Mode] menu appears.
- Use the four-way controller (▲▼) to select [Movie].**
- Press the four-way controller (▶).**
The Movie screen appears.
- Use the four-way controller (▲▼) to select [Quality Level].**
- Press the four-way controller (▶).**
A pull-down menu appears.
- Use the four-way controller (▲▼) to change the quality level.**
- Press the OK button.**
The Quality Level setting is saved.
- Press the MENU button twice.**
The camera returns to capture status with the current setting.

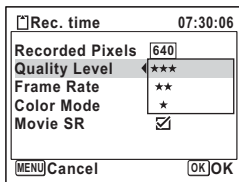

Recorded Pixels, Quality Level and Frame Rate of Movies p.32

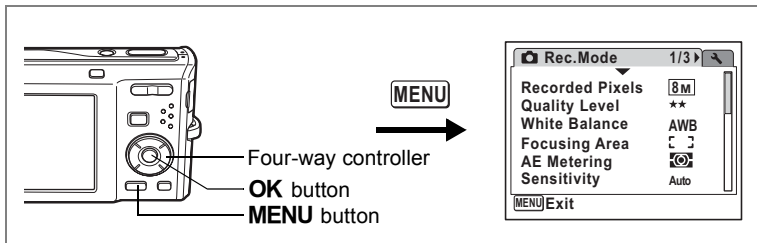

Selecting the Frame Rate

You can choose from two frame rates (number of frames per second) for movies: 30fps (frames per second) and 15fps. The more frames per second, the better the quality of the movie, but the file size becomes larger.

1 Press the **MENU** button in mode.

The [Rec.Mode] menu appears.

2 Use the four-way controller () to select [Movie].

3 Press the four-way controller ().

The Movie screen appears.

4 Use the four-way controller () to select [Frame Rate].

5 Press the four-way controller ().

A pull-down menu appears.

6 Use the four-way controller () to select [30fps] or [15fps].

7 Press the **OK** button.

The Frame Rate setting is saved.

8 Press the **MENU** button twice.

The camera returns to capture status with the current setting.

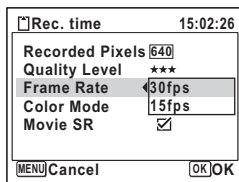

Recorded Pixels, Quality Level and Frame Rate of Movies p.32

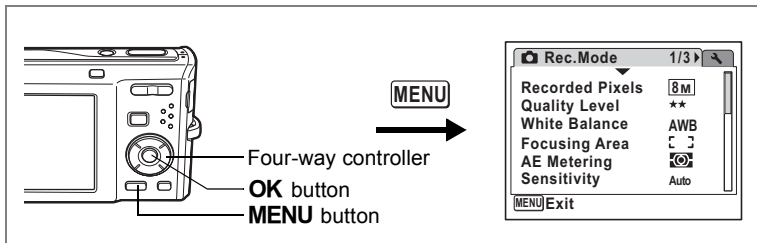

Recording Movies in Black and White or Sepia Tones (Color Mode)

In (Movie) mode, you can set the color mode to black and white or sepia, as well as full color.

- 1 Press the MENU button in mode.**
The [Rec.Mode] menu appears.
- 2 Use the four-way controller (▲▼) to select [Movie].**
- 3 Press the four-way controller (▶).**
The Movie screen appears.
- 4 Use the four-way controller (▲▼) to select [Color Mode].**
- 5 Press the four-way controller (▶).**
A pull-down menu appears.
- 6 Use the four-way controller (▲▼) to choose a color.**
- 7 Press the OK button.**
The Color Mode setting is saved.
- 8 Press the MENU button twice.**
The camera returns to capture status with the current setting.

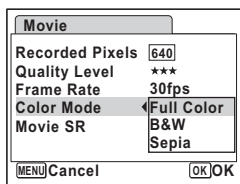

The color mode setting cannot be changed after a movie is recorded.

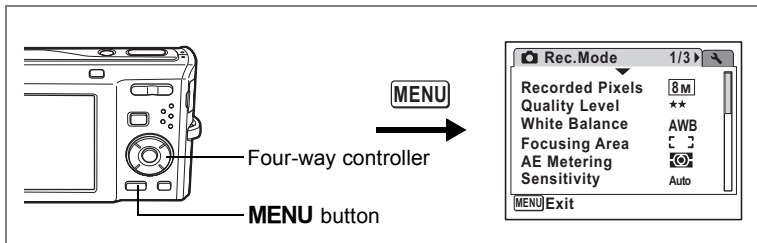

Setting the Movie SR (Movie Shake Reduction) Function

4

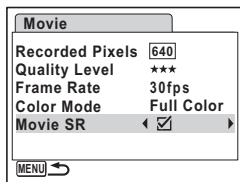

In (Movie) mode, you can compensate for camera shake while you are recording movies with the Movie SR (Movie Shake Reduction) function.

- 1 Press the MENU button in mode.**
The [Rec.Mode] menu appears.
- 2 Use the four-way controller (▲▼) to select [Movie].**
- 3 Press the four-way controller (▶).**
The Movie screen appears.
- 4 Use the four-way controller (▲▼) to select [Movie SR].**
- 5 Use the four-way controller (◀▶) to select (On) or (Off).**
The Movie SR (Movie Shake Reduction) setting is saved.
- 6 Press the MENU button twice.**
The camera returns to capture status with the current setting.



Playing Back Images

Switching Between Mode and Mode

In this manual, the capture mode, such as for taking still pictures, is referred to as [ mode]. The playback mode, such as for displaying captured images on the display, is referred to as [ mode]. In  mode, you can perform simple editing operations on the images that are played back.

Follow the procedure below to switch between  mode and  mode.

To Switch from Mode to Mode

1 Press the button.

The camera switches to  mode.



To Switch from Mode to Mode

1 Press the button or shutter release button halfway.

The camera switches to  mode.

Displaying data in the built-in memory

When an SD Memory Card is inserted in the camera, images, movies, and sounds in the SD Memory Card are displayed. If you want to display images, movies, and sounds in the built-in memory, remove the SD Memory Card.

- **[Viewing images in the built-in memory while the SD Memory Card is inserted (built-in memory display)]**
 - When switching from  mode to  mode, you can display images, movies, and sounds in the built-in memory while the SD Memory Card is inserted by pressing the  button for more than one second.
 - In built-in memory display, you can play back still pictures (including enlarged display) (p.42, p.118), movies (p.125), and sounds (p.159), and switch between nine-image display, folder display, and calendar display (p.117).
 - In built-in memory display, you cannot delete data, delete a selection, display the Playback Mode Palette, or display the menu. If you want to perform any of these operations on images, movies, or sounds in the built-in memory, do so after removing the SD Memory Card.

Playing Back Still Pictures

Refer to “Playing Back Images” (p.42) for instructions.

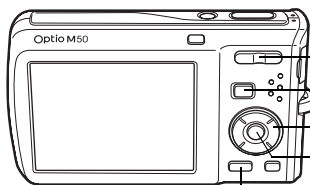

Zoom/Matrix/Quick button

Play button

Four-way controller

OK button

MENU button

Nine-Image Display, Folder Display and Calendar Display

Nine-Image Display

You can display nine thumbnails of captured images at a time.

1 In **Play** mode, press **Zoom/Matrix/Quick** on the **Zoom/Matrix/Quick** button.



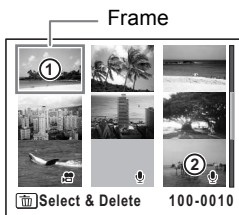

A page consisting of nine thumbnail images appears. The displayed images change nine at a time page by page.

Use the four-way controller (**▲▼◀▶**) to move the frame. When 10 or more images have been saved, if you choose image ①

and press the four-way controller (**▲◀**), the previous page appears. Similarly, if you choose image ② and press the four-way controller (**▼▶**), the next page appears.



The icons that appear on the images indicate the following:

- No icon : Still picture without sound
-  : Still picture that can have camera shake corrected
-  (with image) : Still picture with sound
-  : Movie (first frame appears)
-  (without image) : Sound file only

Press the **OK** button, **MENU** button or **Q** on the **Zoom/Matrix/Quick** button to switch to single-image display of the selected image.

Press the **Play** button to switch to **Camera** mode.

Switching to Folder Display or Calendar Display

In nine-image display, press on the Zoom// button to switch to folder display or calendar display. Press the Green button to switch between folder display and calendar display.

1 In mode, press on the Zoom// button.

The screen changes to nine-image display.

2 Press on the Zoom// button.

The screen changes to folder display or calendar display.

Folder display

The list of folders with recorded images and sound files appears.

Use the four-way controller () to move the frame.

Press the **OK** button or on the Zoom// button to display the images in the selected folder in nine-image display.

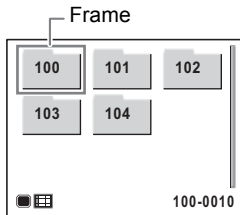

Calendar display

Recorded images and sound files are displayed by date in calendar format.

The first image recorded on a date is displayed for that date on the calendar.

appears for dates on which a sound file was the first recorded file.

Use the four-way controller () to move the frame.

Press on the Zoom// button to display the images for a date in nine-image display.

Select a date and press the **OK** button to switch to single-image display of the first image recorded on that date.



- Press the **MENU** button in folder display or calendar display to switch to normal nine-image display.
- Press the button or half-press the shutter release button in folder display or calendar display to switch to mode.

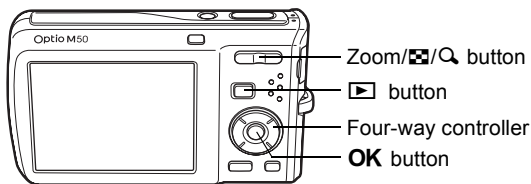

Zoom Playback

You can magnify an image up to eight times. A guide showing the center of the magnified portion of the image appears on the display during zoom playback.

1 Enter the Play mode and use the four-way controller (◀▶) to choose the image you want to magnify.

2 Press Q on the Zoom/Matrix/Quick button.

The image is magnified (×1.1 to ×8). Holding down Q on the Zoom/Matrix/Quick button changes the magnification continuously. When the Quick Zoom function (p.176) is set to , you can magnify the image at a maximum of ×8 simply by pressing Q once. You can use the guide at the bottom left of the screen to check which portion of the image is magnified.



Guide

The following operations can be performed while the magnified image is displayed.

- | | |
|------------------------------|-------------------------------------|
| Four-way controller (▲▼◀▶) | Moves the position to be magnified |
| Zoom/Matrix/Quick button (Q) | Makes the image bigger (max. ×8) |
| Zoom/Matrix/Quick button (Q) | Makes the image smaller (min. ×1.1) |

3 Press the OK button.

The image returns to single-image display.



- Movies cannot be magnified.
- The guide does not appear if the display mode is set to "No Info".

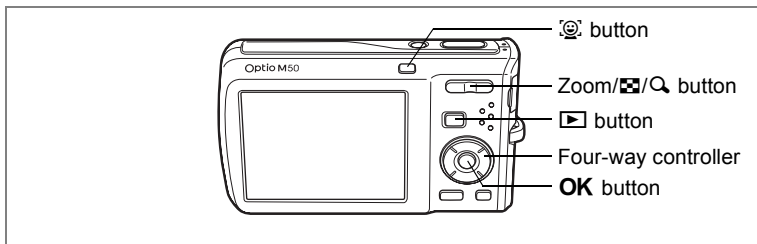

Zoom Up On the Subject's Face Automatically (Face close-up playback)

You can enjoy playing back images with the subject's faces zoomed up simply by pressing the smiley face icon button (Face close-up playback) if Face Recognition operated when the images were taken.

- 1 Enter the play mode and use the four-way controller (◀▶) to choose the image you want to magnify.**
- 2 Confirm that the smiley face icon is displayed in the image and press the smiley face icon button.**

The image is magnified around the face first recognized when the image was taken.



If multiple faces were recognized when the image was taken, the subject's faces are zoomed up on each time the smiley face icon button is pressed in order of the recognition during shooting.



- 3 Press the OK button.**

The image returns to single-image display.



- The magnification ratio for Face close-up playback may differ depending the conditions such as the size of the face recognized when shooting.
- Press on the Zoom// button during Face close-up playback to switch to the zoom playback; the image is displayed at an equal or slightly larger magnification ratio. Press on the Zoom// button to switch to the zoom playback; the image is displayed at an equal or slightly smaller magnification ratio.

Displaying Shooting Information in Playback Mode

Shooting information can be displayed on the display in  mode. Pressing the **OK/DISPLAY** button changes the display mode. Refer to p.20 for details of each display mode.

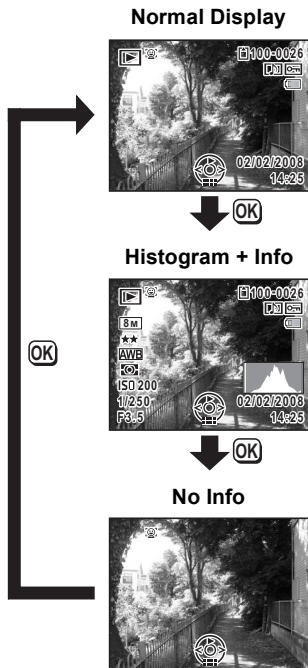

Displaying Shooting Information in Capture Mode  p.85

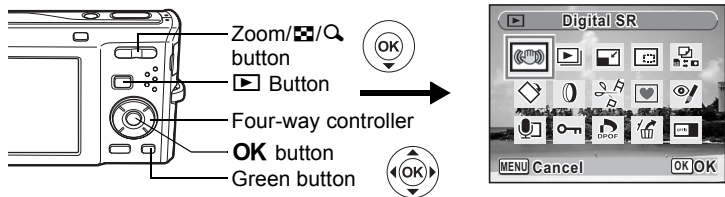

Correcting Camera Shake with Digital SR

For correcting the camera shake in recorded images.

- 1** Enter the mode and use the four-way controller (◀▶) to choose the image to correct camera shake for.
- 2** Press the four-way controller (▼).
The Playback Mode Palette appears.
- 3** Use the four-way controller (▲▼◀▶) to select (Digital SR).
- 4** Press the OK button.
The image to correct is displayed.
- 5** Press the OK button.
- 6** Use the four-way controller (▲▼) to select [Overwrite] or [Save as].
If the image is protected, you can only select [Save as].
- 7** Press the OK button.
The corrected image is saved in the built-in memory or SD Memory Card.

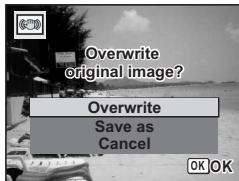



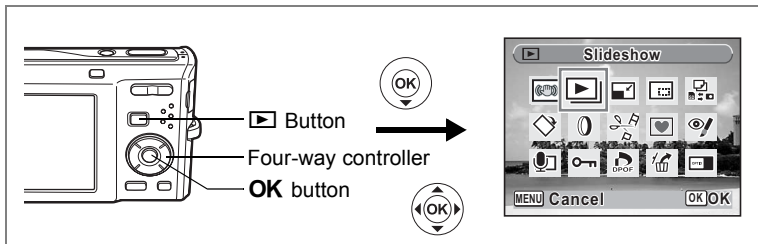





- If you overwrite the image, the shake information is lost, and you cannot perform shake correction again.
- appears on the upper left of the display only when playing back images for which camera shake can be corrected. However, camera shake may not be corrected when the camera shake is too extreme. In such cases, the error message will appear in step 5.









Slideshow

You can play back recorded images one after another.

- 1 Enter the  mode and use the four-way controller ( ) to choose an image to start the slideshow with.**
- 2 Press the four-way controller (.**
The Playback Mode Palette appears.
- 3 Use the four-way controller (   ) to select  (Slideshow).**
- 4 Press the OK button twice.**
The slideshow starts.
Pressing the **OK** button during the slideshow pauses the slideshow. To resume the slideshow, press the **OK** button while the slideshow is paused.
- 5 Press any button other than the OK button.**
The slideshow stops.

Setting the Slideshow Conditions

You can set the playback interval and also a screen effect and sound effect for when one image changes to the next.

- 1 Press the four-way controller ( in  mode.**
The Playback Mode Palette appears.
- 2 Use the four-way controller (   ) to select  (Slideshow).**

3 Press the OK button.

The screen for setting the slideshow conditions appears.

4 Use the four-way controller (▲▼) to select [Interval].**5 Press the four-way controller (▶).**

A pull-down menu appears.

6 Use the four-way controller (▲▼) to change the interval and press the OK button.

You can choose from 3sec, 5sec, 10sec, 20sec, and 30sec.

7 Use the four-way controller (▲▼) to select [Screen Effect].

After selecting [Screen Effect], press the four-way controller (▶). A pull-down menu appears with the following items that can be selected. Use the four-way controller (▲▼) to select an item and press the **OK** button.

Wipe	The next image slides over the previous one from left to right
Checker	The next image appears in small square mosaic blocks
Fade	The current image gradually fades out and the next image fades in
Off	No effect

8 Use the four-way controller (▲▼) to select [Sound Effect].**9 Use the four-way controller (◀▶) to select (On) or (Off).**

Except when the screen effect is set to Off, you can choose (On) or (Off) for the sound that is played when one image changes to the next.

10 Press the OK button.

The slideshow starts using the selected interval and effect.



- The slideshow will continue until you press any button other than the **OK** button.
- Movies or pictures with sound will normally be played through to the end before the next picture is played back, regardless of the interval setting. However, pressing the four-way controller (▶) while playing back a movie or a picture with sound skips to the next image.
- Sound files made in (Voice Recording) mode are not played back in the slideshow.
- Panorama images will be scrolled for display from left to right in 4 seconds before the next picture is played back, regardless of the settings of [Interval] or [Screen Effect].

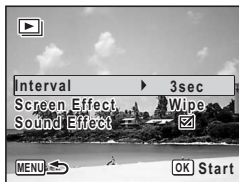



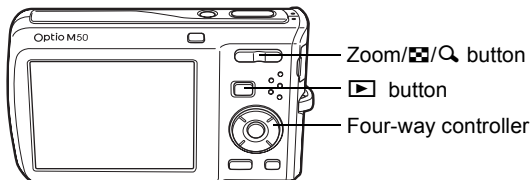

Playing Back Movies



Playing Back a Movie





You can play back the movies you have taken. Sound is played back at the same time.

1 Enter the  mode and use the four-way controller ( ) to choose the movie you want to play back.



2 Press the four-way controller ().
Playback starts.



The following operations can be performed during playback.

- Four-way controller () Plays back in reverse
- Four-way controller () Pauses playback
- Zoom/Matrix/Quick button () Increases the volume
- Zoom/Matrix/Quick button () Reduces the volume

The following operations can be performed while playback is paused.

- Four-way controller () Reverses the frame
- Four-way controller () Forwards the frame
- Four-way controller () Releases the Pause function (Play)

3 Press the four-way controller ().
Playback stops.

Connecting the Camera to AV Equipment

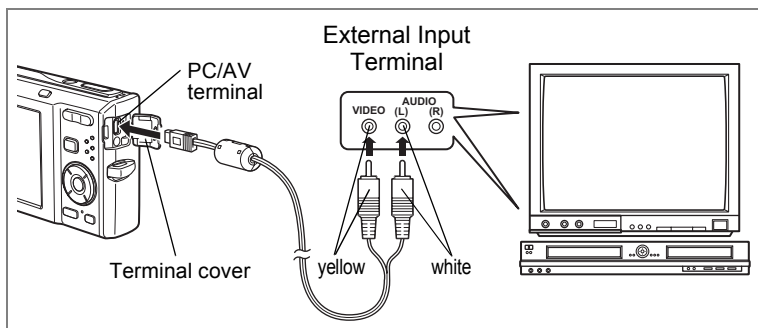

By using the AV cable, you can capture and play back images on equipment with a video IN jack, such as a TV. Make sure the camera and TV are turned off before connecting the camera to the TV.

5

Playing Back and Deleting Images

1 Open the terminal cover and connect the AV cable to the PC/AV terminal.

Connect the terminal of the AV cable with ⇐ pointing toward the ◀ on the PC/AV terminal of the camera.

2 Connect the other ends of the AV cable (yellow: video, white: audio) to the video input terminal and audio input terminal of the AV device.

When using stereo sound equipment, insert the sound terminal into the L (white) terminal.

3 Turn the AV device on.

When the device that the camera is connected to and the device that plays back images are different, turn both devices on.

When viewing images on AV equipment with multiple video input terminals (such as a TV), refer to the operation manual of the device and select the video input terminal to which the camera is connected.

4 Turn the camera on.



- You are recommended to use the AC adapter kit K-AC78 (optional) if you intend to use the camera for a long time.
- Depending on the country or region, images and sound files may fail to be played back if the video output format is set different from the one in use there. If this happens, change the video output format setting. (p.172)
- The camera display turns off while the camera is connected to AV equipment.
- Volume cannot be adjusted with the zoom button while the camera is connected to AV equipment.

Deleting Images

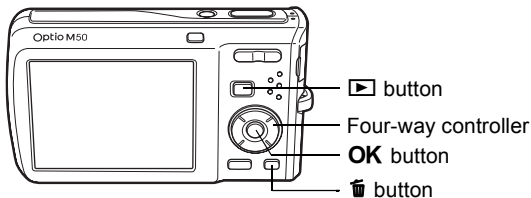

Delete images and sounds with mistakes or that are unnecessary.

When images or sounds are inadvertently deleted







Deleted images and sounds can be recovered with the Optio M50. (p.133)
Deleted images and sounds can be recovered even if the camera has been turned off after deletion as long as the SD Memory Card has not been removed. However, deleted images and sounds cannot be recovered after operations to write data such as taking pictures, recording movies, protecting images, saving DPOF settings, resizing images, or cropping images have been performed.

Deleting a Single Image/Sound File

You can delete a single image or sound file.



Protected images and sound files cannot be deleted. (p.134)

- 1 Enter the  mode and use the four-way controller ( ) to choose the image/sound file you want to delete.**
- 2 Press the .**
A confirmation screen appears.
- 3 Use the four-way controller ( ) to select [Delete].**
- 4 Press the OK button.**
The image or sound file is deleted.





If you press the  button during Instant Review, the screen in Step 2 appears, enabling you to delete the image you have just taken. (p.43)

Recovering Deleted Images  p.133

Deleting a Sound File

If sound has been recorded with an image (p.160), you can delete the sound without deleting the image.

- 1 Enter the  mode and use the four-way controller (◀▶) to choose an image with sound.**
- 2 Press the  button.**
A confirmation screen appears.
- 3 Use the four-way controller (▲▼) to select [Delete Sound].**
- 4 Press the OK button.**

The sound file is deleted.



Select [Delete] in Step 3 above to delete both the image and sound file.

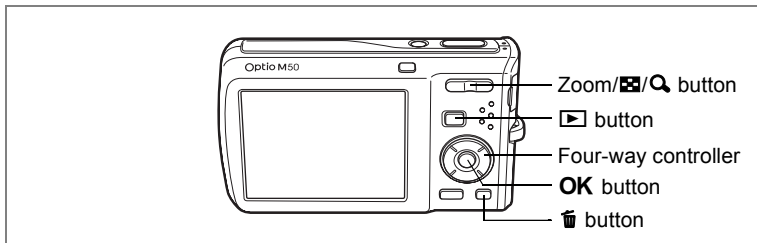

Deleting Selected Images and Sound Files (from Nine-Image Display)

You can delete several images/sound files selected from the nine-image display at once.

Caution:

Protected images and sound files cannot be deleted.

1 In mode, press on the Zoom//Q button.

Nine thumbnail images appear.

2 Press the button.

appears on the images and sound files.



3 Use the four-way controller () to choose the images and sound files that you want to delete and press the **OK** button.

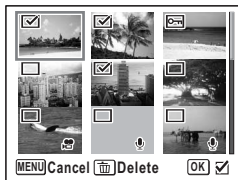

appears on the selected images and sound files.



If you select an image and press on the Zoom//Q button, the selected image appears in single-image display as long as the button is pressed, enabling you to check whether you really want to delete it or not. (The display returns to the nine-image display when you release the button.) However, protected images cannot be displayed in single-image display.

4 Press the  button.

A confirmation dialog appears.

5 Use the four-way controller ( ) to select [Select & Delete].

6 Press the OK button.

The selected images and sound files are deleted.



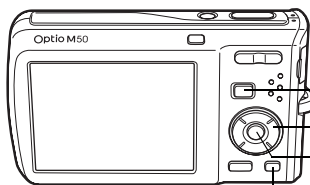

- ▶ button
- Four-way controller
- OK button
- 🗑 button

Deleting All Images and Sound Files

You can delete all the images and sound files at once.



Protected images and sound files cannot be deleted. (p.134)

5

Playing Back and Deleting Images

- 1 Press the 🗑 button in ▶ mode.**
A confirmation dialog appears.
- 2 Press the 🗑 button.**
A confirmation dialog appears.
- 3 Use the four-way controller (▲▼) to select [Delete All].**
- 4 Press the OK button.**
All the images and sound files are deleted.

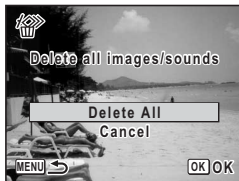

Recovering Deleted Images p.133

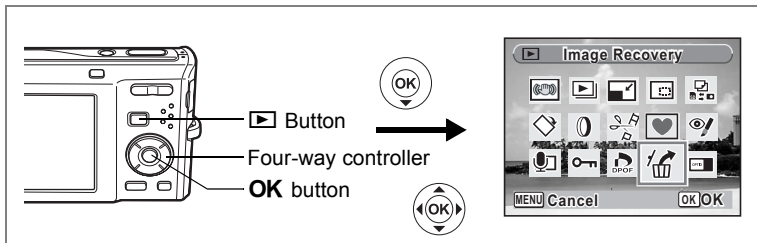

Recovering Deleted Images

You can recover images or sound files that were taken with this camera and then deleted.



After deleting an image, once operations to write data such as taking pictures, recording movies, protecting images, saving DPOF settings, resizing images, or cropping images have been performed, or the SD Memory Card has been removed, the message “No image to be processed” appears in Step 3 and the deleted images and sound files cannot be recovered.

- 1 After deleting a file, press the four-way controller (▼).**
The Playback Mode Palette appears.
- 2 Use the four-way controller (▲▼◀▶) to select .**
(Image Recovery).
- 3 Press the OK button.**
The number of recoverable images appears.
- 4 Use the four-way controller (▲▼) to select [Recover].**
- 5 Press the OK button.**



Deletion of the images is cancelled and the files are recovered.



- Recovered images and sound files have the same file name as before they were deleted.
- Up to a maximum of 999 deleted image files can be recovered.

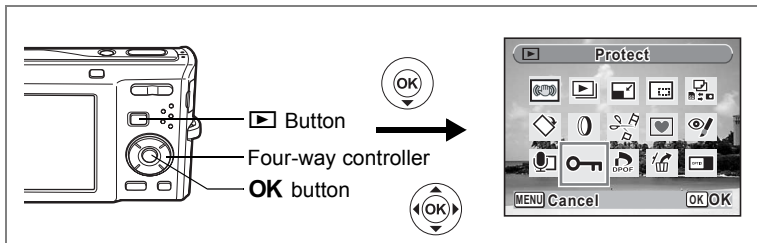

Protecting Images and Sound Files from Deletion (Protect)

You can protect stored images and sound files from being accidentally deleted.

- 1 Press the four-way controller (▼) in [▶] mode.**
The Playback Mode Palette appears.
- 2 Use the four-way controller (▲▼◀▶) to select [Protect].**
- 3 Press the OK button.**
The screen for selecting [Single image/sound] or [All Images/Sounds] appears.
- 4 Use the four-way controller (▲▼) to select [Single image/sound].**
- 5 Press the OK button.**
The message [Protect this image/sound] appears.
To protect another image or sound file, use the four-way controller (◀▶) to select another image or sound file.
- 6 Use the four-way controller (▲▼) to select [Protect].**
- 7 Press the OK button.**
The selected image or sound file is protected.



- To cancel the Protect setting, select [Unprotect] in Step 6.
- [Key icon] appears below the file number on protected images and sound files during playback.
- You can protect another image or sound file by further performing the above 5, 6, and 7 Steps. However, the maximum number you can protect in succession by the above Steps cannot exceed 99.

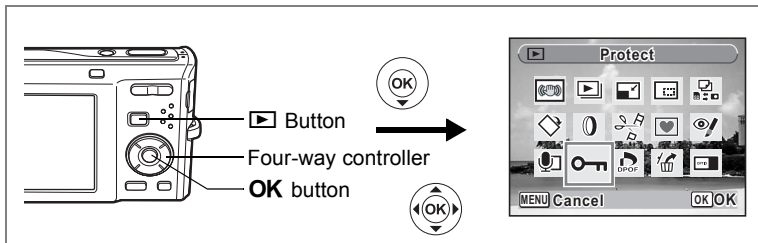

Protecting All Images and Sound Files

- 1 **Press the four-way controller (▼) in [▶] mode.**
The Playback Mode Palette appears.
- 2 **Use the four-way controller (▲▼◀▶) to select [Protect].**
- 3 **Press the OK button.**
The screen for selecting [Single image/sound] or [All Images/Sounds] appears.
- 4 **Use the four-way controller (▲▼) to select [All Images/Sounds].**
- 5 **Press the OK button.**
The screen for selecting [Protect] or [Unprotect] appears.
- 6 **Use the four-way controller (▲▼) to select [Protect].**
- 7 **Press the OK button.**
All the images and sound files are protected.



Protected images and sound files will be deleted when the SD Memory Card or built-in memory is formatted.



To cancel the Protect setting on all your images and sound files, select [Unprotect] in Step 6.

Editing Images

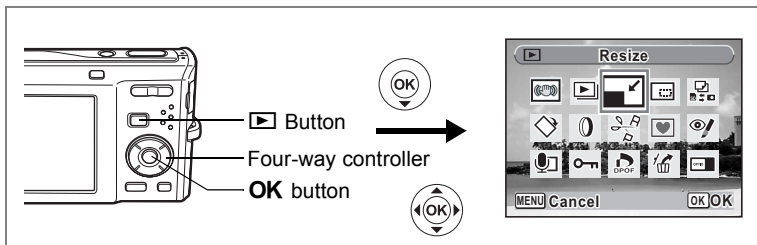

Changing the Image Size and Quality (Resize)

By changing the size and quality of a selected image, you can make the file size smaller than the original. You can use this function to continue taking pictures when the SD Memory Card or built-in memory is full, by making the images smaller and overwriting the original images to make more space available.



- Movies cannot be resized.
- You cannot select a larger resolution or higher quality than that of the original image.

- 1 Enter the mode and use the four-way controller (◀▶) to choose the image you want to resize.**
- 2 Press the four-way controller (▼).**
The Playback Mode Palette appears.
- 3 Use the four-way controller (▲▼◀▶) to select (Resize).**
- 4 Press the OK button.**
The screen for choosing the size and quality appears.
- 5 Select [Recorded Pixels] and [Quality Level].**

Use the four-way controller (◀▶) to choose the size and quality.

Use the four-way controller (▲▼) to switch between [Recorded Pixels] and [Quality Level].



6 Press the OK button.

A confirmation dialog for overwriting the image appears.
[Save as] is the only available option for protected images.

7 Use the four-way controller (▲▼) to select [Overwrite] or [Save as].

8 Press the OK button.

The resized image is saved.



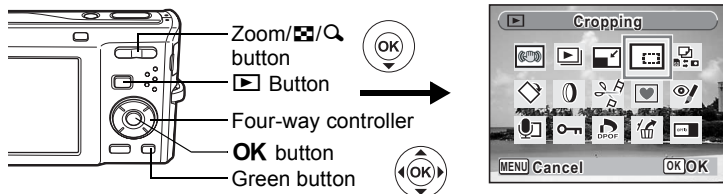

Cropping Images

You can delete the unwanted part of a picture and save the cropped image as a separate image.

- 1** Enter the mode and use the four-way controller () to choose the image you want to trim.
- 2** Press the four-way controller ().
The Playback Mode Palette appears.
- 3** Use the four-way controller () to select (Cropping).
- 4** Press the **OK** button.
The cropping screen appears.
- 5** Choose the cropping conditions.

Zoom//Quality button

Changes the size of the cropped section

Four-way controller ()

Moves the cropping position up, down, left and right

Green button Rotates the cropping frame

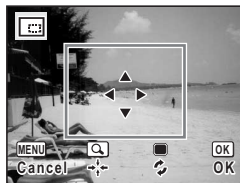

- 6** Press the **OK** button.
The cropped image is saved with a new file name.
The cropped image is saved in the same quality as the original image.
The number of recorded pixels is selected automatically according to the size of the cropped section.



Movies cannot be cropped.

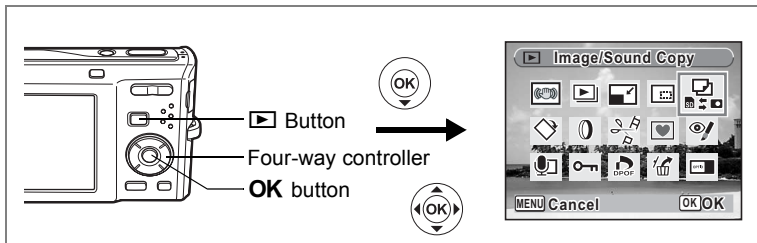

Copying Images and Sound Files

You can copy images and sound files from the built-in memory to the SD Memory Card and vice versa. This function can only be selected when an SD Memory Card has been inserted in the camera.



Make sure that the camera is turned off before inserting or removing the SD Memory Card.

- 1 Press the four-way controller (▼) in [▶] mode.**
The Playback Mode Palette appears.
- 2 Use the four-way controller (▲▼◀▶) to select [Image/Sound Copy].**
- 3 Press the OK button.**
The copying method selection screen appears.

To Copy Files from the Built-in Memory to the SD Memory Card

All the images and sound files in the built-in memory are copied to the SD Memory Card at once. Before copying the images, make sure that there is enough space in the SD Memory Card.

- 4 Use the four-way controller (▲▼) to select [Built-in Memory] → [SD].**
- 5 Press the OK button.**
All the images and sound files are copied.

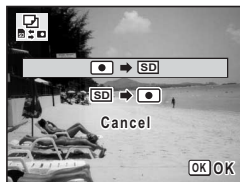

To Copy Files from the SD Memory Card to the Built-in Memory

Selected images and sound files from the SD Memory Card are copied to the built-in memory one at a time.

- 4 Use the four-way controller (▲▼) to select [SD] → [●].
- 5 Press the OK button.
- 6 Use the four-way controller (◀▶) to select the file you want to copy.
- 7 Press the OK button.



The selected image/sound file is copied.



- If sound has been recorded with the image, the sound file is copied with the image.
- When a file is copied from the SD Memory Card to the built-in memory, it is assigned a new file name.

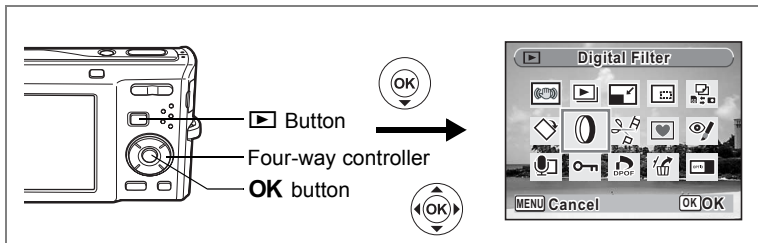

Using the Digital Filters

This mode lets you change the color tones and perform special processing on a selected image.

Digital Filters

B&W/sepia filter	Processes the image using the selected filter. You can choose from two filters: B&W and sepia.
Color filter	Processes the image using the selected color filter. You can choose from six filters: red, pink, purple, blue, green, and yellow.
Color extraction filter	Processes the image using the selected color extraction filter. You can choose from three filters: Red, Green, and Blue.
Soft filter	Processes the image into a soft image with the entire image blurred.
Brightness Filter	Adjusts the brightness of the image.

- 1 Enter the mode and use the four-way controller () to choose the image you want to edit.**
- 2 Press the four-way controller ().**
The Playback Mode Palette appears.
- 3 Use the four-way controller () to select (Digital Filter).**
- 4 Press the OK button.**
The digital filter selection screen appears.
 - B&W/sepia filter
 - Color filter
 - Color extraction filter
 - Soft filter
 - Brightness Filter

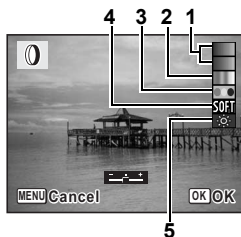

To Select a B&W/sepia filter or the Soft Filter

- 5 Use the four-way controller (▲▼) to choose a digital filter.

You can preview the results of the filter effect.

- 6 Press the **OK** button.

A confirmation dialog for overwriting the image appears.

- 7 Use the four-way controller (▲▼) to select **[Overwrite]** or **[Save as]**.

[Save as] is the only available option for protected images.

- 8 Press the **OK** button.

Images processed with a B&W/sepia filter or the soft filter are recorded with the same number of recorded pixels and quality level as the original image.

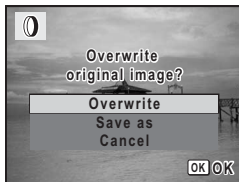

To Select a Color filter or the Color Extraction Filter

- 5 Use the four-way controller (▲▼) to choose a digital filter.

- 6 Use the four-way controller (◀▶) to adjust the effect.

The color extraction filter changes in the following sequence each time you press the four-way controller (▶): Green, Blue, Red.

- 7 Press the **OK** button.

A confirmation dialog for overwriting the image appears.

- 8 Use the four-way controller (▲▼) to select **[Overwrite]** or **[Save as]**.

[Save as] is the only available option for protected images.

- 9 Press the **OK** button.

Images processed with a color filter or the color extraction filter are recorded with the same number of recorded pixels and quality level as the original image.

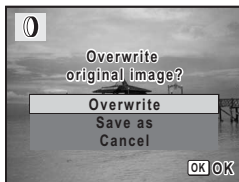

To Select the Brightness Filter

5 Use the four-way controller (▲▼) to select the digital filter you want to use.

6 Use the four-way controller (◀▶) to adjust the effect.

For the brightness filter, the brightness increases each time you press the four-way controller (▶) and decreases each time you press the four-way controller (◀).



7 Press the OK button.

A confirmation dialog for overwriting the image appears.

8 Use the four-way controller (▲▼) to select [Overwrite] or [Save as].

[Save as] is the only available option for protected images.

9 Press the OK button.

The edited image is saved with the same number of recorded pixels and quality level as the original.



Movies or images taken with another camera cannot be edited using [Digital Filter]. An error message appears if you choose this function from the Playback Mode Palette and press the **OK** button.

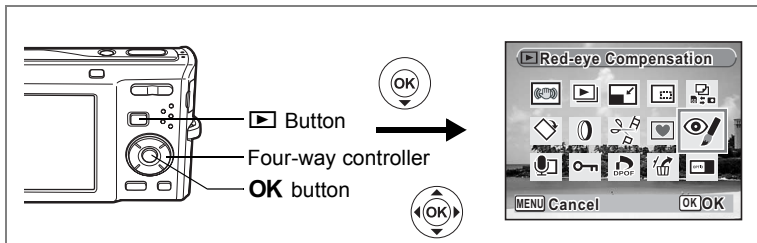

Red-eye Compensation

You can correct images where the flash has caused the subject to appear with red eyes.

- 1 Enter the mode and use the four-way controller () to choose the image you want to correct.**
- 2 Press the four-way controller ().**
The Playback Mode Palette appears.
- 3 Use the four-way controller () to select (Red-eye Compensation).**
- 4 Press the OK button.**
A confirmation dialog for overwriting the image appears.
- 5 Use the four-way controller () to select [Overwrite] or [Save as].**
[Save as] is the only available option for protected images.
- 6 Press the OK button.**

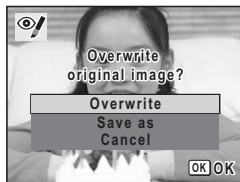

- The red-eye compensation function cannot be used on movies or on images where red eyes cannot be detected on the camera. An error message appears in Step 4.
- The red-eye compensation function can only be used with still pictures taken with this camera.

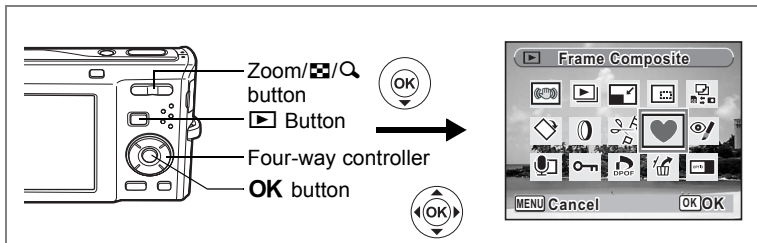

Adding a Frame (Frame Composite)

This function lets you add a decorative frame to still pictures. There are three frames already stored in the camera.

1 Enter the mode and use the four-way controller (◀▶) to choose the image to which you want to add a frame.

2 Press the four-way controller (▼).

The Playback Mode Palette appears.

3 Use the four-way controller (▲▼◀▶) to select (Frame Composite).

4 Press the OK button.

A 9-frame display of the frame selection screen appears.

5 Use the four-way controller (▲▼◀▶) to choose a frame.

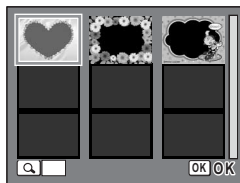

6 Press on the Zoom/Matrix/Zoom Out button.

The selected frame appears in single-image display.

You can choose another frame using either of the following operations.

- Use the four-way controller (◀▶) to choose a different frame.
- Press on the Zoom/Matrix/Zoom Out button to return to the 9-frame display of the frame selection screen, and then perform Step 5 to choose a different frame.



7 Press the **OK** button.

The frame position and size adjustment screen appears. Use the four-way controller (▲▼◀▶) to adjust the position of the image, and use the Zoom/☒/🔍 button to make the image larger or smaller.

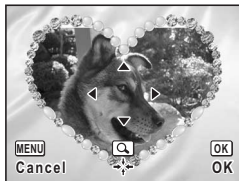

8 Press the **OK** button.

A confirmation dialog for overwriting the image appears.

9 Use the four-way controller (▲▼) to select **[Overwrite]** or **[Save as]**.

[Save as] is the only available option for protected images.



10 Press the **OK** button.

The edited image is saved with the recorded pixels of **[3M]**.

Caution

The Frame Composite function cannot be used on movies or images of size **[2M]** or smaller. An error message appears in Step 4.

6

Using a New Frame

Frames downloaded from a PENTAX website or other source can be used when adding a frame to pictures. To display the frames available in the built-in memory or the SD Memory Card, in Step 3, select **☑** (Frame Composite) and press the **OK** button.

Caution

- The three frames stored in the internal memory cannot be deleted.
- Up to 96 downloaded frames can be displayed. Including the three frames already stored in the internal memory, you can choose from up to 99 frames.
- Extract the downloaded frame and copy it to the FRAME folder in the Built-in memory or SD Memory Card.
- The FRAME folder is created when the built-in memory or SD Memory Card is formatted with this camera.

How to display the Movie Edit menu

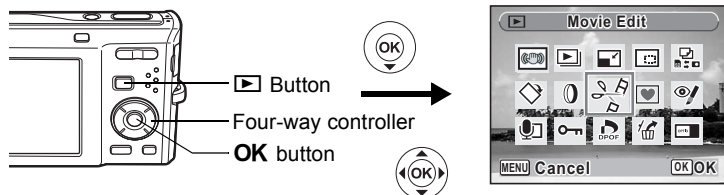

Editing Movies

You can select a frame from a recorded movie to save as a still picture or divide a movie into two.

- 1 Enter the mode and use the four-way controller () to choose the movie you want to edit.**
- 2 Press the four-way controller ().**
- 3 Use the four-way controller () to select (Movie Edit).**
- 4 Press the OK button.**

The movie edit selection screen appears.

Go to the following pages.

- Saving a Frame from a Movie as a Still Picture
- “Dividing a Movie” (p.148)



Protected movies cannot be divided.

Saving a Frame from a Movie as a Still Picture

- 5 Select [Save as Still image] on the movie edit selection screen.**

6 Press the OK button.

The screen appears for selecting a frame to be saved as a still picture.

7 Use the four-way controller (▲▼◀▶) to choose the frame you want to save.

- ▲ : Plays or pauses the movie
- ▼ : Stops the movie and returns to the first frame
- ◀ : Reverses the movie frame by frame
- ▶ : Advances the movie frame by frame

8 Press the OK button.

The selected frame is saved as a still picture.

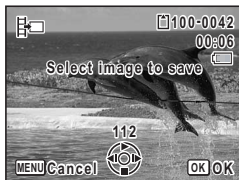

Dividing a Movie

5 Select [Divide Movies] on the movie edit selection screen.

6 Press the OK button.

The screen for choosing the dividing position appears.

7 Use the four-way controller (▲▼◀▶) to determine the dividing position.

- ▲ : Plays or pauses the movie
- ▼ : Stops the movie and returns to the first frame
- ◀ : Reverses the movie frame by frame
- ▶ : Advances the movie frame by frame

8 Press the OK button.

A confirmation dialog appears.

9 Use the four-way controller (▲▼) to select [Divide].

10 Press the OK button.

The movie is divided at the specified position, the two portions are saved as new files, and the original one is deleted.

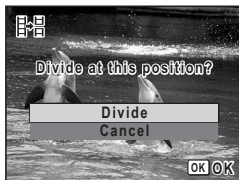

Setting the Printing Service (DPOF)

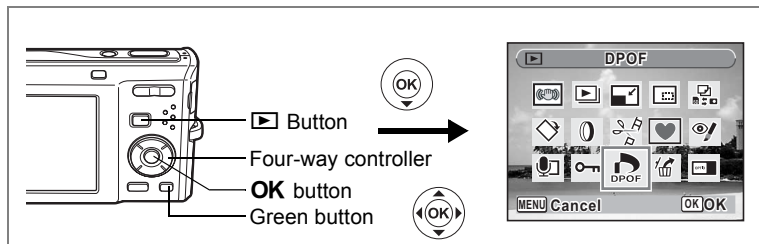

DPOF (Digital Print Order Format) is the format for storing print order data on still pictures captured with a digital camera. Once the print order data has been stored, the pictures can be printed according to the DPOF settings using a DPOF-compatible printer or photo processing lab. You cannot store print order data for movies or sound-only files.



Printing Single Images

Set the following items for each image.

Copies	Choose the number of copies up to 99.
Date	Specify whether you want the date inserted on the print or not.

- 1 In  mode, press the four-way controller (▼).**
The Playback Mode Palette appears.
- 2 Use the four-way controller (▲▼◀▶) to select  (DPOF).**
- 3 Press the OK button.**
The screen for selecting [Single Image] or [All Images] appears.
- 4 Use the four-way controller (▲▼) to select [Single Image].**



5 Press the **OK** button.

The message [DPOF setting for this image] appears.

To make DPOF settings for another image, use the four-way controller (◀▶) to select another image.

If DPOF settings have already been made for an image, the previous number of copies and date setting (☑ or ☐) will be displayed.



6 Use the four-way controller (▲▼) to choose the number of copies.

7 Use the Green button to choose whether to insert the date or not.

☑ (On) : The date will be imprinted.

☐ (Off) : The date will not be imprinted.

To continue setting DPOF print order data, use the four-way controller (◀▶) to choose another image and repeat Steps 6 and 7.

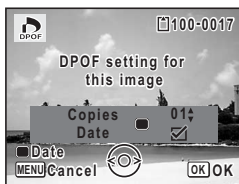

8 Press the **OK** button.

The DPOF settings are saved and the screen returns to the DPOF menu.

Caution

Depending on the printer or printing equipment at the photo processing lab, the date may not be imprinted on the pictures even if ☑ (On) was selected in the DPOF settings.

memo

To cancel DPOF settings, set the number of copies to [00] in Step 6 and press the **OK** button.

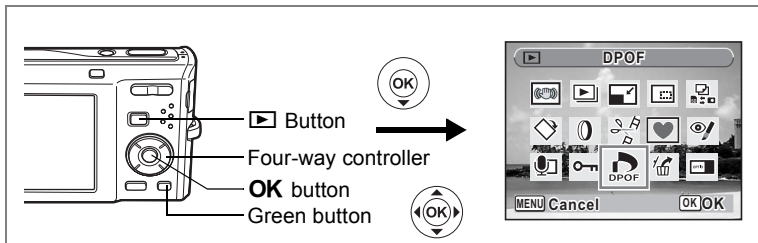

Printing All Images

When you choose the number of copies and whether or not to insert the date, the settings are applied to all the images stored in the camera.

- 1 Display the screen for DPOF settings in mode.**
Refer to Steps 1 to 3 on p.149.
- 2 Use the four-way controller () to select [All Images].**
- 3 Press the OK button.**

The message [DPOF setting for all images] appears.

- 4 Choose the number of copies and whether to insert the date or not.**

Refer to Steps 6 and 7 in "Printing Single Images" (p.150) for details of how to make the settings.

- 5 Press the OK button.**

The DPOF settings for all the images are saved and the camera returns to the DPOF setting screen.



The number of copies specified in the DPOF settings applies to all the images. Before printing, check that the number is correct.



Settings for single images are canceled when settings are made for all images.



Printing Using PictBridge

By connecting the camera to a printer that supports PictBridge using the USB cable (I-USB7) provided, you can print images directly from the camera without using a PC. Connect the camera to the printer and select the images you want to print and the number of copies on the camera.



- You are recommended to use the AC adapter kit K-AC78 when the camera is connected to the printer. The printer may not work properly or the image data may be lost if the battery runs out of power while the camera is connected to the printer.
- Do not disconnect the USB cable during data transfer.
- Depending on the model of printer, not all the settings made on the camera (such as print settings and DPOF settings) may be valid.
- A printing error may occur if the selected number of copies exceeds 500.
- Printing the index of the images (printing multiple images on a single sheet) cannot be performed directly from the camera. Make the settings on a printer supporting index printing function or use a PC.

6

Connecting the Camera to the Printer

- 1 Select [PictBridge] for the [USB Connection] mode on the [Setting] menu.**
Refer to “Changing the USB Connection Mode” (p.171).
- 2 Turn off the camera.**
- 3 Connect the camera to the printer using the USB cable provided.**
- 4 Turn the printer on.**
- 5 When the printer is ready to print, turn the camera on.**

The printing mode selection screen appears.

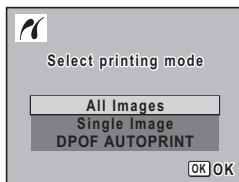

Printing Single Images

- 1 In the printing mode selection screen, use the four-way controller (▲▼) to select [Single Image].**
- 2 Press the OK button.**
The setting screen appears.
- 3 Use the four-way controller (◀▶) to choose an image to print.**
- 4 Use the four-way controller (▲▼) to choose the number of copies.**
You can print up to 99 copies.
- 5 Use the Green button to choose whether to insert the date or not.**
 - (On) : The date will be imprinted.
 - (Off) : The date will not be imprinted.
- 6 Press the OK button.**
A confirmation dialog appears.
To print the pictures according to the print settings on the printer, press the **OK** button.
To change the print settings, go to Step 7.
- 7 Press the Green button.**
The screen for changing the print settings appears.
- 8 Select [Paper Size] and press the four-way controller (▶).**

The Paper Size screen appears.

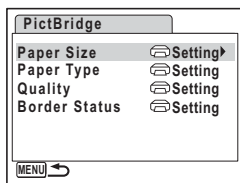
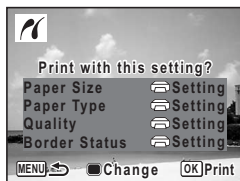
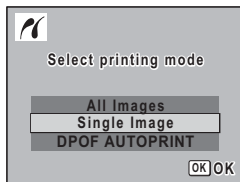

9 Use the four-way controller (▲▼◀▶) to choose the paper size.

You can only choose a size that is supported by your printer.

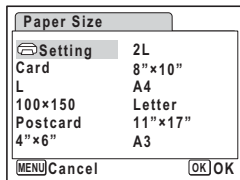

10 Press the OK button.

The Paper Size setting is saved, and the screen returns to the print settings screen.

11 Use the four-way controller (▲▼) to select [Paper Type] and press the four-way controller (▶).

A pull-down menu appears.

12 Use the four-way controller (▲▼) to select the paper type and press the OK button.

The Paper Type setting is saved, and the screen returns to the print settings screen. Set [Quality] and [Border Status] in the same way as in Steps 11 and 12.

If you select [⊞ Setting] for each print setting, images are printed according to the settings made on the printer.

Paper Type with more ★ supports higher quality paper.

Quality with more ★ indicates higher print quality.

A confirmation dialog appears after each item has been set.

13 Press the MENU button.

The screen returns to the confirmation dialog.

14 Press the OK button.

The image is printed according to the settings.

Press the **MENU** button to cancel printing.



- The self-timer lamp lights while the camera is communicating with the printer, and blinks while the card is being accessed and during printing. Do not disconnect the USB cable while the self-timer lamp is blinking.
- The [Paper Size], [Paper Type], [Quality] and [Border Status] settings are reset to the defaults when the camera is turned off.

Disconnecting the Cable from the Printer p.156

Printing All Images

- 1 In the printing mode selection screen, use the four-way controller (▲▼) to select [All Images].**

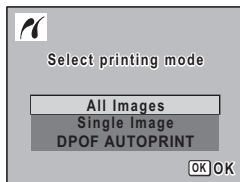

- 2 Press the OK button.**

The setting screen appears.

- 3 Choose the number of copies and whether to insert the date or not.**

The number of copies and date setting that you choose apply to all the images.

Refer to Steps 4 and 5 in "Printing Single Images" (p.153) for details of how to make the settings.

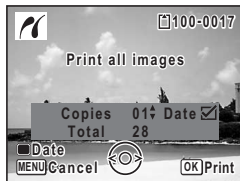

- 4 Press the OK button.**

A confirmation dialog appears.

Refer to Steps 7 to 11 of "Printing Single Images" (p.153 and p.154) for details of changing print settings.

- 5 Press the OK button on the print settings confirmation screen.**

All the images are printed according to the settings.

Press the **MENU** button to cancel printing.

Printing Using the DPOF Settings

1 In the printing mode selection screen, use the four-way controller (▲▼) to select [DPOF AUTOPRINT].

2 Press the **OK** button.

The DPOF settings you have made appear. Use the four-way controller (◀▶) to check the number of copies for each picture, whether to insert the date or not, and the total number of copies. Refer to p.149 for instructions on how to make the DPOF settings.

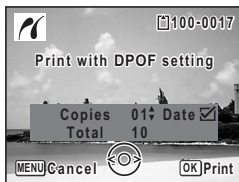

3 Press the **OK** button.

A confirmation dialog appears.

Refer to Steps 7 to 11 of “Printing Single Images” (p.153 and p.154) for details of changing print settings.

4 Press the **OK** button.

The images are printed according to the settings.

Press the **MENU** button to cancel printing.

6



If the picture already has the date imprinted on it (p.105), do not set Date (On) in DPOF settings. Otherwise, the date could be imprinted twice on your printed picture.

Disconnecting the Cable from the Printer

Disconnect the USB cable from the camera and printer when you have finished printing.

1 Turn off the camera.

2 Disconnect the USB cable from the camera and printer.

Recording Sound (Voice Recording Mode)

You can record sound with the camera. The microphone is located on the front of the camera. When recording sound, aim the camera to obtain the best conditions.

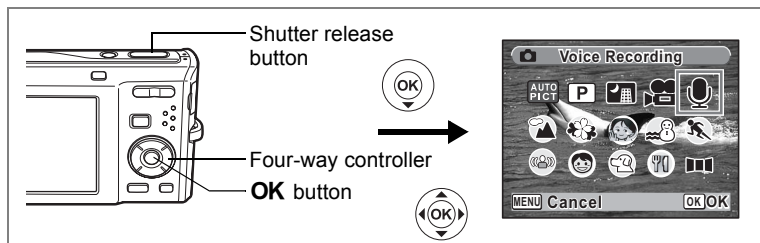
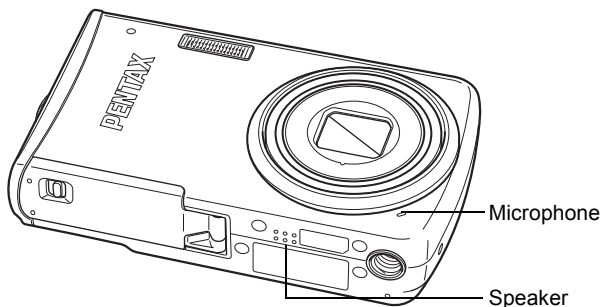

- 1 Press the four-way controller (▼) in mode.**
The Capture Mode Palette appears.
- 2 Use the four-way controller (▲▼◀▶) to select (Voice Recording).**

3 Press the OK button.

The remaining recordable time and the recording time of the current file appear on the display.

- 1 Recording time
- 2 Remaining recordable time



4 Press the shutter release button fully.

Recording starts. The self-timer lamp blinks during recording.

You can record sounds continuously for up to 24 hours.

When the Green button is pressed during recording, an index is added to the current sound file.



5 Press the shutter release button fully.

Recording stops.





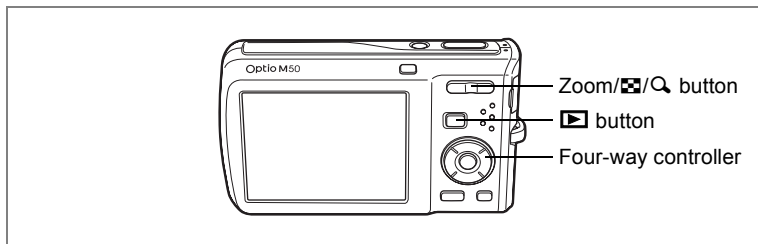

- If you press and hold down the shutter release button for more than one second in Step 4, recording continues until you take your finger off the button. This is useful for making short sound recordings.
- Sound is saved in WAVE monaural files.

Playing Back Sound

You can play back the sound files you made in  mode.



- 1 Press the  button.**
- 2 Use the four-way controller ( ) to choose a sound file to play back.**
- 3 Press the four-way controller ().**



The sound file is played back.

1 Total file recording time

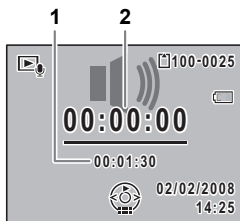
2 Playback time





The following operations can be performed during playback.

- Four-way controller () Pauses playback
- Zoom/Matrix/Quick button () Increases the volume
- Zoom/Matrix/Quick button () Reduces the volume



If there are no recorded indexes:

- Four-way controller () Reverses playback
- Four-way controller () Fast forwards playback

If there are recorded indexes:

- Four-way controller () Plays back starting from the previous index
- Four-way controller () Plays back starting from the next index

The following operations can be performed while playback is paused.

- Four-way controller () Resumes playback
- Four-way controller () Rewinds approx. 5 seconds
- Four-way controller () Advances approx. 5 seconds

- 4 Press the four-way controller ().**

Playback stops.

Adding a Voice Memo to Images

You can add a voice memo to your still pictures.

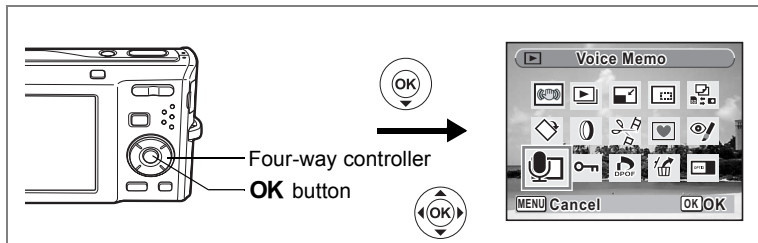

Recording a Voice Memo

- 1 Enter  mode and use the four-way controller (◀▶) to choose the still picture to which you want to add a voice memo.**
- 2 Press the four-way controller (▼).**

The Playback Mode Palette appears.
- 3 Use the four-way controller (▲▼◀▶) to select  (Voice Memo).**
- 4 Press the OK button.**

Recording starts. You can record a voice memo continuously for up to 24 hours.
- 5 Press the OK button.**

Recording stops.



- A voice memo cannot be added to an image that already has a voice memo. Delete the old voice memo and record a new one. (p.129)
- A voice memo cannot be added to protected () images (p.134).

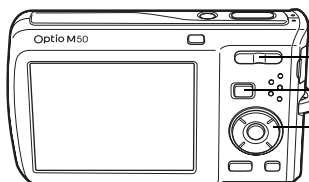

Zoom/▲▲▲/▲ button

▶ button

Four-way controller

Playing Back a Voice Memo

- 1 Enter ▶ mode and use the four-way controller (◀▶) to choose the still picture with the voice memo that you want to play back.**

[] appears on images with voice memos in single-image display.



- 2 Press the four-way controller (▲).**

Playback starts.

The following operations can be performed during playback.

Zoom/▲▲▲/▲ button (▲) Increases the volume

Zoom/▲▲▲/▲ button (▲▲▲) Reduces the volume

- 3 Press the four-way controller (▼).**

Playback stops.

Deleting a Sound File p.129

Camera Settings

How to display the [Setting] menu

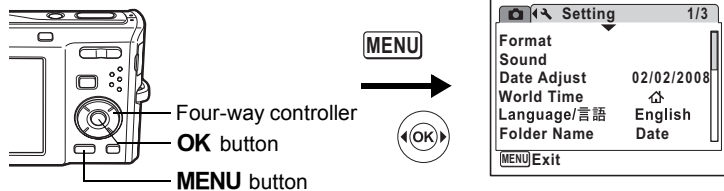

Formatting an SD Memory Card or the Built-in Memory

Formatting will delete all the data on the SD Memory Card. All the data in the built-in memory will be deleted if no SD Memory Card is inserted in the camera.

Caution

- Do not remove the SD Memory Card during formatting as this may damage the card and render it unusable.
- Formatting will delete protected images and any data recorded on the card with a camera other than this camera.
- SD Memory Cards formatted on a PC or device other than the camera cannot be used. Be sure to format the card with the camera.

8

Settings

- 1 Use the four-way controller (▲▼) to select [Format] on the [Setting] menu.**
- 2 Press the four-way controller (▶).**
The Format screen appears.
- 3 Use the four-way controller (▲▼) to select [Format].**
- 4 Press the OK button.**

When formatting is completed, the camera returns to Capture mode or Playback mode.

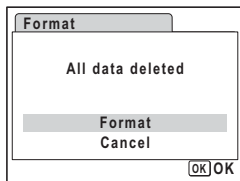

How to display the [↖ Setting] menu

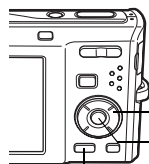

Four-way controller

OK button

MENU button

MENU

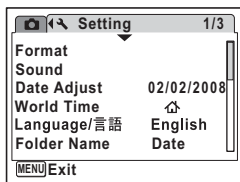

Changing the Sound Settings

You can adjust the volume of operation sounds and change the type of sound.

- 1 Use the four-way controller (▲▼) to select [Sound] on the [↖ Setting] menu.
- 2 Press the four-way controller (▶).
The Sound screen appears.

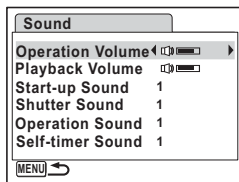

Changing the Operation Volume/Playback Volume

- 3 Use the four-way controller (▲▼) to select [Operation Volume].
- 4 Use the four-way controller (◀▶) to adjust the volume.
The selected volume is saved.
Set the volume to 0 to mute the start-up sound, shutter sound, operation sound, and self-timer sound.
- 5 Change [Playback Volume] in the same way as in Steps 3 to 4.

Changing the Sound Type

- 6** Use the four-way controller (▲▼) to select [Start-up Sound].
- 7** Press the four-way controller (▶).
A pull-down menu appears.
- 8** Use the four-way controller (▲▼) to select [1], [2], [3] or [Off] and press the **OK** button.
The selected sound type is saved.
- 9** Set [Shutter Sound], [Operation Sound] and [Self-timer Sound] in the same way as in Steps 6 to 8.
- 10** Press the **MENU** button.
The setting is changed and the screen returns to the [↖ Setting] menu.

How to display the [Setting] menu

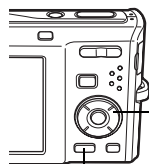

Four-way controller

MENU button

MENU

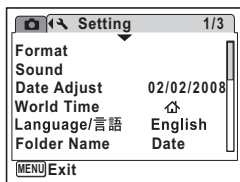

Changing the Date and Time

You can change the initial date and time settings. You can also set the style in which the date appears on the camera.

1 Use the four-way controller (▲▼) to select [Date Adjust] on the [Setting] menu.

2 Press the four-way controller (▶).

The Date Adjust screen appears.

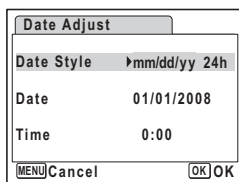

3 Press the four-way controller (▶).

The frame moves to [mm/dd/yy].

Depending on the initial setting or previous setting, [dd/mm/yy] or [yy/mm/dd] may be displayed.

4 Use the four-way controller (▲▼) to choose the date and time display style.

Choose [mm/dd/yy], [dd/mm/yy] or [yy/mm/dd].

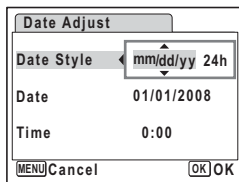

5 Press the four-way controller (▶).

The frame moves to [24h].

6 Use the four-way controller (▲▼) to select [24h] (24-hour display) or [12h] (12-hour display).

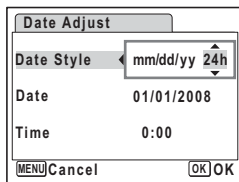

7 Press the four-way controller (▶).

The frame returns to [Date Style].

8 Press the four-way controller (▼).

The frame moves to [Date].

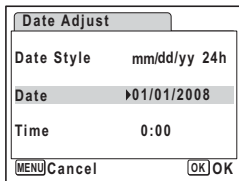

9 Press the four-way controller (▶).

The frame moves to one of the following items depending on the date style set in Step 4.

For [mm/dd/yy] month (Example: [01])

For [dd/mm/yy] day (Example: [01])

For [yy/mm/dd] year (Example: [2008])

The following operations and screens use [mm/dd/yy] as an example. The operations are the same even if another date style has been selected.

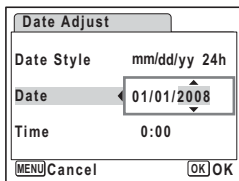

10 Use the four-way controller (▲▼) to change the month.

11 Press the four-way controller (▶).

The frame moves to the day field. Use the four-way controller (▲▼) to change the day. After changing the day, change the year in the same manner.

8

12 Change the time in the same way as in Steps 7 to 10.

If you selected [12h] in Step 6, the setting switches between am and pm corresponding to the time.

13 Press the OK button.

The date and time settings are saved.



When you finish the settings and press the **OK** button, the camera clock is reset to 00 seconds. To set the exact time, press the **OK** button when the time signal (on the TV, radio, etc.) reaches 00 seconds.

How to display the [↖ Setting] menu

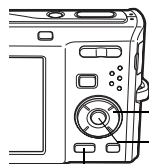

Four-way controller

OK button

MENU button

MENU

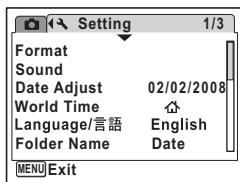

Setting the World Time

The date and time selected in “Setting the Date and Time” (p.38) and “Changing the Date and Time” (p.165) serve as the ⬆ (Hometown) date and time. By using the world time function, you can display the time in a city other than the Hometown (→ Destination). This is useful when taking pictures in a different time zone.

Setting the Destination

- 1 Use the four-way controller (▲▼) to select [World Time] on the [↖ Setting] menu.**
- 2 Press the four-way controller (▶).**
The World Time screen appears.
- 3 Use the four-way controller (▲▼) to select → (Destination).**
- 4 Press the four-way controller (▶).**
The Destination screen appears. The city that is currently selected blinks on the map.
- 5 Use the four-way controller (◀▶) to change the Destination city.**
The current time, location and time difference of the selected city appear.
- 6 Use the four-way controller (▲▼) to select [DST].**
- 7 Use the four-way controller (◀▶) to select (On) or (Off).**
Select (On) if the Destination city uses daylight saving time.

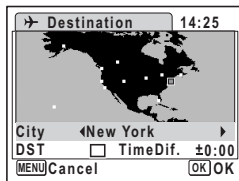

8

Settings

8 Press the OK button.

The World Time setting is saved.

9 Press the MENU button twice.

The camera returns to capture status with the current setting.



Select (Hometown) in Step 3 of p.167 to set the city and DST setting for the Hometown city.

Displaying the Time of the Destination on the display (Select Time)

1 Use the four-way controller (▲▼) to select [World Time] on the [Setting] menu.

2 Press the four-way controller (▶).

The World Time screen appears.

3 Use the four-way controller (▲▼) to select [Select time].



4 Press the four-way controller (▶).

A pull-down menu appears.

5 Use the four-way controller (▲▼) to select (Destination) or (Hometown).

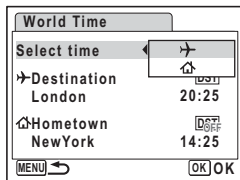

: Displays the time in the city selected as the Destination city

: Displays the time in the city selected as the Hometown city

6 Press the OK button.

The Select time setting is saved.

7 Press the MENU button twice.

The camera returns to mode or mode.

(Destination) appears on the display when the camera returns to mode and World Time is selected.



How to display the [Setting] menu

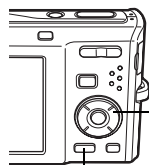

Four-way controller

MENU button

MENU

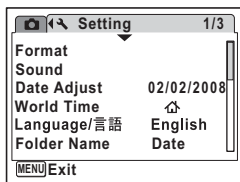

Changing the Display Language

You can change the language in which the menus, error messages, etc. are displayed.

The camera supports the following 19 languages: English, French, German, Spanish, Portuguese, Italian, Dutch, Danish, Swedish, Finnish, Polish, Czech, Hungarian, Turkish, Russian, Thai, Korean, Chinese (traditional and simplified) and Japanese.

- 1 Use the four-way controller (▲▼) to select [Language/言語] on the [Setting] menu.**
- 2 Press the four-way controller (▶).**
The [Language/言語] screen appears.
- 3 Use the four-way controller (▲▼◀▶) to select the language.**
- 4 Press the OK button.**



The selected language is set to be displayed.

How to display the [Setting] menu

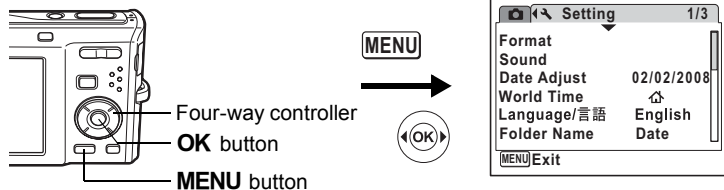

Changing the Image Folder Name

You can change the image folder name to Standard or Date that pictures were taken. When the name is changed to the date, pictures are saved in separate folders by the date they were taken.

Folder Name

Standard	xxxPENTX (where xxx is the 3-digit folder number)
Date	xxx_mmdd (3-digit folder number_month day) * xxx_ddmm (3-digit folder number_day month) when the date style is set to [dd/mm/yy]

Picture taken with standard folder name
(Example: September 25)

Folder name changed to date setting
(Example: September 25)

Next time a picture is taken
(Example: October 1)

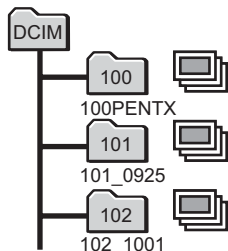
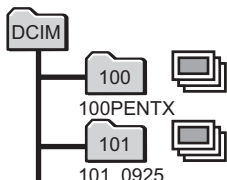
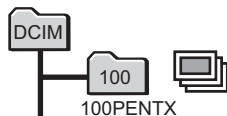

- Up to 900 folders can be created.
- Up to 999 images or sounds can be saved in a folder.

- 1 Use the four-way controller (▲▼) to select [Folder Name] on the [Setting] menu.**
- 2 Press the four-way controller (▶).**
A pull-down menu appears.
- 3 Use the four-way controller (▲▼) to select [Standard] or [Date].**
- 4 Press the OK button.**
The Folder Name setting is saved.

How to display the [Setting] menu

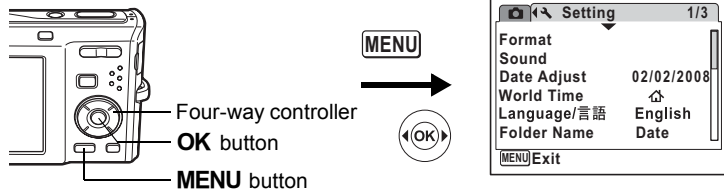

Changing the USB Connection Mode

Choose the appropriate USB connection mode depending on whether you are going to connect the USB cable to a PC or a PictBridge-compatible printer.



Refer to the PC Connection Manual for instructions on connecting the camera to a computer.

- 1 Use the four-way controller (▲▼) to select [USB Connection] on the [Setting] menu.**
- 2 Press the four-way controller (▶).**
A pull-down menu appears.
- 3 Use the four-way controller (▲▼) to select [PC] or [PictBridge].**

[PC] : Select this option when transferring image data to a computer

[PictBridge] : Select this option when connecting the camera to a PictBridge-compatible printer

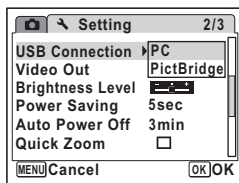

- 4 Press the OK button.**

The USB Connection setting is saved.



Do not connect the camera to your PC while [PictBridge] is selected for the USB Connection mode. And do not connect the camera to your printer while [PC] is selected.

How to display the [Setting] menu

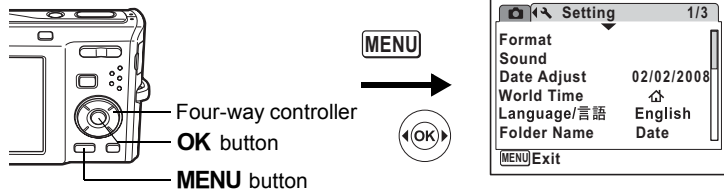

Changing the Video Output Format

When you connect the camera to AV equipment, choose the appropriate video output format (NTSC or PAL) for taking and playing back images.

1 Use the four-way controller (▲▼) to select [Video Out] on the [Setting] menu.

2 Press the four-way controller (▶).

A pull-down menu appears.

3 Use the four-way controller (▲▼) to select [NTSC] or [PAL].

Choose the video output format to match the output format of the AV equipment.

4 Press the OK button.

The Video Out setting is saved.

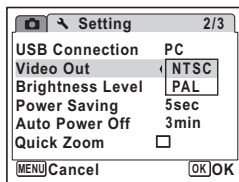

8

Settings



Depending on the country or region, images and sound files may fail to be played back if the video output format is set different from the one in use there. If this happens, change the video output format setting.

Connecting the Camera to AV Equipment p.126

How to display the [Setting] menu

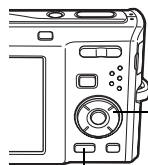

Four-way controller

MENU button

MENU

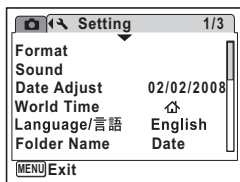

Adjusting the Brightness of the Display

You can adjust the brightness of the display.

- 1 Use the four-way controller (▲▼) to select [Brightness Level] on the [Setting] menu.**
- 2 Use the four-way controller (◀▶) to adjust the brightness.**

The following setting is saved.

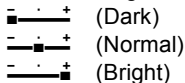

- 3 Press the MENU button.**

The camera returns to Capture mode or Playback mode.

The display is displayed with the set brightness. To change the brightness setting, perform the above steps again.

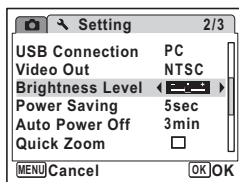

How to display the [↖ Setting] menu

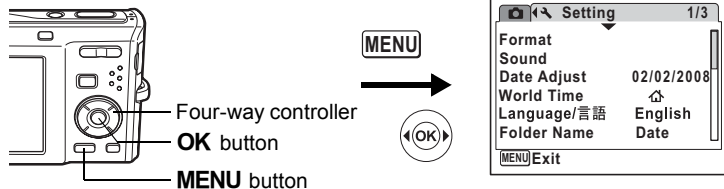

Using the Power Saving Function

You can save battery power by setting the display to dim automatically when no operation is performed for a fixed time. After the power saving function has been activated, the display returns to the ordinary brightness by pressing any of the buttons.

- 1 Use the four-way controller (▲▼) to select [Power Saving] on the [↖ Setting] menu.**
- 2 Press the four-way controller (▶).**
A pull-down menu appears.
- 3 Use the four-way controller (▲▼) to select [2min], [1min], [30sec], [15sec], [5sec] or [Off].**
- 4 Press the OK button.**

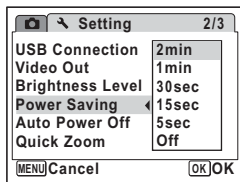

The Power Saving setting is saved.



- Power Saving does not function in the following situations:
 - while taking pictures in Continuous Shooting mode
 - in Playback mode
 - while the camera is connected to a PC or printer
 - when using the AC adapter
 - while recording a movie
 - while the menu is being displayed
- When no operation is performed after the camera is turned on, Power Saving is activated only after 15 seconds elapse even if [5sec] is selected.

How to display the [Setting] menu

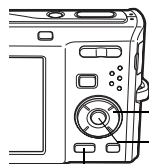

Four-way controller

OK button

MENU button

MENU

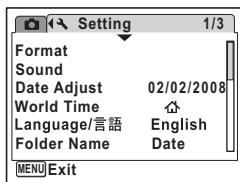

Setting Auto Power Off

You can set the camera to turn off automatically when no operation is performed for a fixed time.

- 1 Use the four-way controller (▲▼) to select [Auto Power Off] on the [Setting] menu.**
- 2 Press the four-way controller (▶).**
A pull-down menu appears.
- 3 Use the four-way controller (▲▼) to select [5min], [3min] or [Off].**
- 4 Press the OK button.**

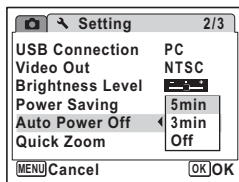

The Auto Power Off setting is saved.





Auto Power Off does not function in the following situations:



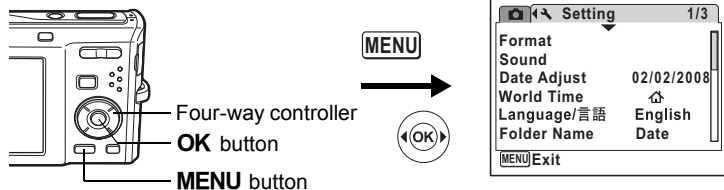

- while recording sound in  (Voice Recording) mode
- while taking pictures in Continuous Shooting mode
- while recording a movie
- while playing back sound
- during a slideshow or movie playback
- while the camera is connected to a PC or printer



How to display the [Setting] menu



Setting the Quick Zoom Function

You can choose whether or not to use the Quick Zoom function that magnifies an image to a maximum of $\times 8$ by just pressing  on the Zoom/ button while playing back an image.

- 1 Use the four-way controller ( ) to select [Quick Zoom] on the [Setting] menu.**
- 2 Use the four-way controller ( ) to select (On) or (Off).**
 - (On): The Quick Zoom is available.
 - (Off): The Quick Zoom is not available.
- 3 Press the MENU button.**

The camera returns to  mode or  mode. Repeat the above steps to change the setting.

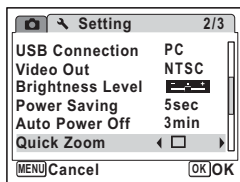

How to display the [Setting] menu

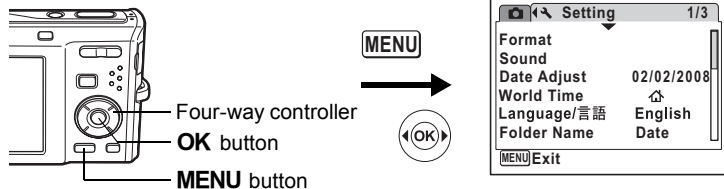

Setting the Guide Display

You can choose whether or not to display a guide for the mode you choose in the Capture Mode Palette (p.53) and Playback Mode Palette (p.59).

- 1 Use the four-way controller (▲▼) to select [Guide Display] on the [Setting] menu.**
- 2 Use the four-way controller (◀▶) to select (On) or (Off).**
 - (ON): The mode guide is displayed.
 - (OFF): The mode guide is not displayed.
- 3 Press the MENU button.**

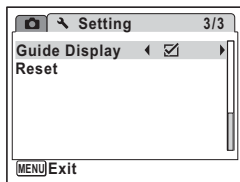

The camera returns to mode or mode. Repeat the above steps to change the setting.

How to display the [Setting] menu

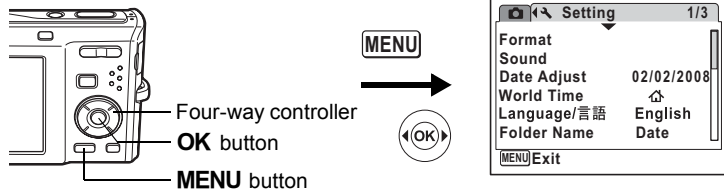

Resetting to Default Settings (Reset)

You can reset the camera settings to their defaults. Refer to “Default Settings” (p.181) for the reset settings.

- 1 Use the four-way controller (▲▼) to select [Reset] on the [Setting] menu.**
- 2 Press the four-way controller (▶).**
The Reset screen appears.
- 3 Use the four-way controller (▲▼) to select [Reset].**
- 4 Press the OK button.**
The settings return to the defaults.

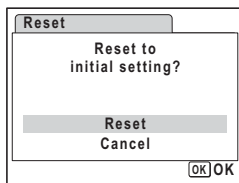
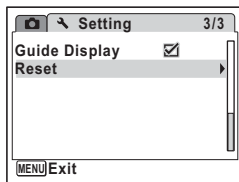

The following settings are not affected by resetting:
Date Adjust, Language/言語, World Time, Video Out.

How to display the Playback Mode Palette

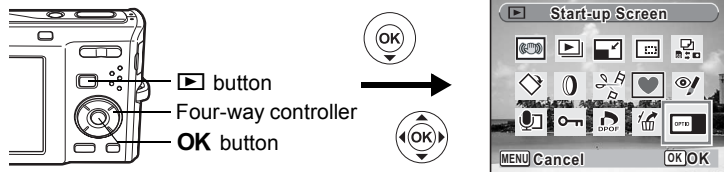

Changing the Start-up Screen

You can choose an image to be displayed as the start-up screen when the camera is turned on.

- 1 Press the **▶** button.**
The camera enters **▶** mode.
- 2 Press the four-way controller (**▼**).**
The Playback Mode Palette appears.
- 3 Use the four-way controller (**▲▼◀▶**) to select **START** (Start-up Screen).**
- 4 Press the OK button.**
The image selection screen appears.
- 5 Use the four-way controller (**◀▶**) to choose an image for the start-up screen.**
- 6 Press the OK button.**
The Start-up Screen setting is saved.



- Once the start-up screen has been set, it will not be deleted even if the original image is deleted or the SD Memory Card or built-in memory is formatted.
- Select **[Off]** to hide the start-up screen.

List of World Time Cities

The column "City" indicates cities that can be set as either the Initial Setting (p.36) or the World Time (p.167).

The column "Video Output Format" indicates the video output format of the city set as the Initial Setting.

Region	City	Video Output Format	Region	City	Video Output Format	
North America	Honolulu	NTSC	Africa/ West Asia	Istanbul	PAL	
	Anchorage	NTSC		Cairo	PAL	
	Vancouver	NTSC		Jerusalem	PAL	
	San Francisco	NTSC		Nairobi	PAL	
	Los Angeles	NTSC		Jeddah	PAL	
	Calgary	NTSC		Tehran	PAL	
	Denver	NTSC		Dubai	PAL	
	Chicago	NTSC		Karachi	PAL	
	Miami	NTSC		Kabul	PAL	
	Toronto	NTSC		Male	PAL	
	New York	NTSC		Delhi	PAL	
Halifax	NTSC	Colombo		PAL		
Central and South America	Mexico City	NTSC		Kathmandu	PAL	
	Lima	NTSC		Dacca	PAL	
	Santiago	NTSC		East Asia	Yangon	NTSC
	Caracas	NTSC			Bangkok	PAL
	Buenos Aires	PAL	Kuala Lumpur		PAL	
	Sao Paulo	PAL	Vientiane		PAL	
Rio de Janeiro	NTSC	Singapore	PAL			
Europe	Lisbon	PAL	Phnom Penh		PAL	
	Madrid	PAL	Ho Chi Minh		PAL	
	London	PAL	Jakarta		PAL	
	Paris	PAL	Hong Kong		PAL	
	Amsterdam	PAL	Beijing		PAL	
	Milan	PAL	Shanghai		PAL	
	Rome	PAL	Manila		NTSC	
	Copenhagen	PAL	Taipei		NTSC	
	Berlin	PAL	Seoul		NTSC	
	Prague	PAL	Tokyo	NTSC		
	Stockholm	PAL	Guam	NTSC		
	Budapest	PAL	Oceania	Perth	PAL	
	Warsaw	PAL		Adelaide	PAL	
	Athens	PAL		Sydney	PAL	
Helsinki	PAL	Noumea		PAL		
Moscow	PAL	Wellington		PAL		
Africa/ West Asia	Dakar	PAL		Auckland	PAL	
	Algiers	PAL		Pago Pago	NTSC	
	Johannesburg	PAL				

Default Settings

The table below lists the factory default settings.

The meaning of the indications for menu items with a default setting is explained below.

Last Memory Setting

Yes : The current setting (last memory) is saved when the camera is turned off.

No : The setting returns to the default setting when the camera is turned off.

* : The setting depends on the [Memory] setting (p.106).



Reset Setting

Yes : The setting returns to the default setting with the Reset function (p.178).



No : The setting is saved even after reset.

● [📷 Rec.Mode] Menu Items

Item	Default Setting	Last Memory Setting	Reset Setting	Page	
Recorded Pixels	(3264×2448)	Yes	Yes	p.91	
Quality Level	★★ (Better)	Yes	Yes	p.93	
White Balance	AWB (Auto)	*	Yes	p.94	
Focusing Area	(Multiple)	Yes	Yes	p.100	
AE Metering	(Multi-segment)	*	Yes	p.96	
Sensitivity	Auto	*	Yes	p.98	
EV Compensation	±0.0	*	Yes	p.84	
Movie	Recorded Pixels	(640×480)	Yes	Yes	p.110
	Quality Level	★★★ (Best)	Yes	Yes	p.111
	Frame Rate	30fps	Yes	Yes	p.112
	Color Mode	Full Color	Yes	Yes	p.113
	Movie SR	<input checked="" type="checkbox"/> (On)	Yes	Yes	p.114
Digital wide	<input checked="" type="checkbox"/> (On)	Yes	Yes	p.83	
Digital Zoom	<input checked="" type="checkbox"/> (On)	*	Yes	p.80	
Instant Review	1 sec	Yes	Yes	p.101	

Item		Default Setting	Last Memory Setting	Reset Setting	Page
Memory	Face Priority	<input type="checkbox"/> (Off)	Yes	Yes	p.56
	Flash Mode	<input checked="" type="checkbox"/> (On)	Yes	Yes	p.89
	Drive Mode	<input type="checkbox"/> (Off)	Yes	Yes	p.76, p.77
	Focus Mode	<input type="checkbox"/> (Off)	Yes	Yes	p.87
	Zoom Position	<input type="checkbox"/> (Off)	Yes	Yes	p.78
	MF Position	<input type="checkbox"/> (Off)	Yes	Yes	p.88
	White Balance	<input type="checkbox"/> (Off)	Yes	Yes	p.94
	Sensitivity	<input type="checkbox"/> (Off)	Yes	Yes	p.98
	EV Compensation	<input type="checkbox"/> (Off)	Yes	Yes	p.84
	AE Metering	<input type="checkbox"/> (Off)	Yes	Yes	p.96
	Digital Zoom	<input checked="" type="checkbox"/> (On)	Yes	Yes	p.80
	DISPLAY	<input type="checkbox"/> (Off)	Yes	Yes	p.85, p.121
File No.	<input checked="" type="checkbox"/> (On)	Yes	Yes	—	
Green Button		Green Mode	Yes	Yes	p.57
Sharpness		 (Normal)	Yes	Yes	p.102
Saturation		 (Normal)	Yes	Yes	p.103
Contrast		 (Normal)	Yes	Yes	p.104
Date Imprint		<input type="checkbox"/> (Off)	Yes	Yes	p.105















● [Setting] Menu Items

Item		Default Setting	Last Memory Setting	Reset Setting	Page
Sound	Operation Volume	3	Yes	Yes	p.163
	Playback Volume	3	Yes	Yes	
	Start-up Sound	1	Yes	Yes	
	Shutter Sound	1	Yes	Yes	
	Operation Sound	1	Yes	Yes	
	Self-timer Sound	1	Yes	Yes	
Date Adjust	Date Style (date)	According to initial setting	Yes	No	p.38
	Date Style (time)	24h	Yes	No	
	Date	1/1/2008	Yes	No	
	Time	According to initial setting	Yes	No	
World Time	World time	Same as  hometown	Yes	Yes	p.167
	Destination (City)	According to initial setting	Yes	No	
	Destination (DST)	<input type="checkbox"/> (Off)	Yes	No	
	Hometown (City)	According to initial setting	Yes	No	
	Hometown (DST)	<input type="checkbox"/> (Off)	Yes	No	
Language/言語		According to initial setting	Yes	No	p.36
Folder Name		Date	Yes	Yes	p.170
USB Connection		PC	Yes	Yes	p.171
Video Out		According to initial setting	Yes	No	p.172
Brightness Level			Yes	Yes	p.173
Power Saving		5 sec	Yes	Yes	p.174
Auto Power Off		3 min	Yes	Yes	p.175
Quick Zoom		<input type="checkbox"/> (Off)	Yes	Yes	p.176
Guide Display		<input checked="" type="checkbox"/> (On)	Yes	Yes	p.177
Reset		—	—	—	p.178

● Playback Mode Palette Items

Item		Default Setting	Last Memory Setting	Reset Setting	Page
Digital SR		—	—	—	p.122
Slideshow	Interval	3 sec	Yes	Yes	p.123
	Screen Effect	Wipe	Yes	Yes	
	Sound Effect	On	Yes	Yes	
Resize	Recorded Pixels	Depending on the picture taken	—	—	p.136
	Quality Level	Depending on the picture taken	—	—	
Cropping		Depending on the picture taken	—	—	p.138
Image/Sound Copy		—	—	—	p.139
Image Rotation		Normal	—	—	p.43
Digital Filter		B&W	No	—	p.141
Movie Edit	Save as Still image	—	—	—	p.145
	Divide Movies	—	—	—	
Frame Composite		Default1	Yes	Yes	p.147
Red-eye Compensation		—	—	—	p.144
Voice Memo		—	—	—	p.160
Protect	Single image/sound	—	—	—	p.134
	All Images/Sounds	—	—	—	
DPOF	Single image	Copies: 0	—	—	p.149
	All Images	Date: <input type="checkbox"/> (Off)	—	—	p.151
Image Recovery		—	—	—	p.133
Start-up Screen		—	Yes	Yes	p.179

● Key Operation

Item	Function	Default Setting	Last Memory Setting	Reset Setting	Page
 button	Operation Mode	 mode	—	—	—
Zoom/    button	Zoom Position	Full wide-angle	*	No	p.78
Four-way controller	 Drive Mode	 (Standard)	*	Yes	p.76, p.77
	 Shooting Mode	 (Auto Picture)	Yes	Yes	p.53
	 Flash Mode	 (Auto)	*	Yes	p.89
	 Focus Mode	AF (Standard)	*	Yes	p.87
MENU button	Menu Display	Capture mode: [ Rec.Mode] menu Playback mode: [ Setting] menu	—	—	p.48
OK/DISPLAY button	Information Display	Normal	*	Yes	p.85, p.121
 button	Operation Mode	Face Priority On	*	Yes	p.56

Functions Available for Each Shooting Mode

Yes : Can be set and function is available. No : Cannot be set.
 # : Can be set but function is not available.

	AUTO PICT	●	P	📷	📹	🎤	📶	👤	👤	👤
Face Priority	Yes	Yes	Yes	Yes	Yes	No	Yes	Yes	Yes	Yes
Smile Capture	Yes	Yes	Yes	Yes	Yes	No	Yes	Yes	Yes	Yes
Face Priority Off	No	Yes	Yes	Yes	Yes	No	Yes	No	No	No
1/2 (Auto)	Yes	Yes	Yes	No	No*4	No	Yes	Yes	Yes	Yes
🔆 (Flash Off)	Yes	Yes	Yes	Yes	Yes*4	No	Yes	Yes	Yes	Yes
🔆 (Flash On)	Yes	No	Yes	Yes	No*4	No	Yes	Yes	Yes	Yes
👤 (Auto + Red-eye)	Yes	No	Yes	No	No*4	No	Yes	Yes	Yes	Yes
👤 (Flash On + Red-eye)	Yes	No	Yes	Yes	No*4	No	Yes	Yes	Yes	Yes
SOFT 1/2 (Soft Flash)	Yes	No	Yes	Yes	No*4	No	Yes	Yes	Yes	Yes
☐ (Single-frame shooting)	Yes	Yes	Yes	Yes	Yes	No	Yes	Yes	Yes	Yes
⌚ (Self-timer)	Yes	Yes*1	Yes	Yes	Yes	No	Yes	Yes	Yes	Yes
⌚ (2 Sec. Self-timer)	Yes	Yes*1	Yes	Yes	Yes	No	Yes	Yes	Yes	Yes
📽 (Continuous Shooting)	No	No	Yes	No	No	No	Yes	Yes	Yes	Yes
📷 (Frame Composite)	No	No	Yes	Yes	No	No	Yes	Yes	Yes	Yes
AF (Standard)	Yes	Yes	Yes	Yes	Yes	No	Yes	Yes	Yes	Yes
📷 (Macro)	Yes	Yes	Yes	Yes	Yes	No	Yes	Yes	Yes	Yes
▲ (Infinity)	Yes	No	Yes	Yes	Yes	No	Yes	Yes	Yes	Yes
PF (Pan Focus)	Yes	Yes	Yes	Yes	Yes	No	Yes	Yes	Yes	Yes
MF (Manual Focus)	Yes	No	Yes	Yes	Yes	No	Yes	Yes	Yes	Yes
Recorded Pixels	Yes	No	Yes	Yes	#*5	#	Yes	Yes	Yes	Yes
Quality Level	Yes	No	Yes	Yes	#*5	#	Yes	Yes	Yes	Yes
White Balance	No*10	No*10	Yes	Yes	Yes	#*8	No*10	No*10	No*10	No*10
Focusing Area	No*11	No*11	Yes	Yes	Yes*12	#	Yes	Yes	Yes	Yes
AE Metering	No*2,3	No*2,3	Yes*3	Yes*3	No*2,3	#	No*2,3	No*2,3	No*2,3	No*2,3
Sensitivity	Yes	No*15	Yes	Yes	No*15	#	Yes	Yes	Yes	Yes
EV Compensation	No	No	Yes	Yes	Yes*6	#	Yes	Yes	Yes	Yes
Digital Zoom	Yes	No	Yes	Yes	Yes	#	Yes	Yes	Yes	Yes
Instant Review	Yes	No	Yes	Yes	#	#	Yes	Yes	Yes	Yes
Memory	Yes	No	Yes	Yes	Yes*7	Yes*7	Yes	Yes	Yes	Yes
Sharpness	No	No	Yes	Yes	Yes	#	No	No	No	No
Saturation	No	No	Yes	Yes	Yes	#	No	No	No	No
Contrast	No	No	Yes	Yes	Yes	#	No	No	No	No
Date Imprint	Yes	No	Yes	Yes	#	#	Yes	Yes	Yes	Yes

*1 If you select one of these functions in another shooting mode and then enter the Green mode, only the function selected is available

*2 Fixed at 📷 (Multi-segment)

*3 Fixed at Face Recognition AE when the subject's face is recognized

*4 Fixed at 🔆 (flash off)

*5 Follows setting for [Movie]

*6 Not available during recording

*7 Some related settings are applied

*8 📷 (Manual) is not available

*9 Fixed at Auto (Sensitivity 64 - 6400)

*10 Fixed at **AWB** (Auto White Balance)

Note: Menu settings cannot be changed when in Digital wide mode.

Yes	Yes	Yes	Yes	Face Priority
Yes	Yes	Yes	Yes	Smile Capture
Yes	Yes	Yes	Yes	Face Priority Off
Yes	Yes	No*4	Yes	(Auto)
Yes	Yes	Yes*4	Yes	(Flash Off)
Yes	Yes	No*4	Yes	(Flash On)
Yes	Yes	No*4	Yes	(Auto + Red-eye)
Yes	Yes	No*4	Yes	(Flash On + Red-eye)
Yes	Yes	No*4	Yes	(Soft Flash)
Yes	Yes	Yes	Yes	(Single-frame shooting)
Yes	Yes	Yes	Yes	(Self-timer)
Yes	Yes	Yes	Yes	(2 Sec. Self-timer)
Yes	Yes	No	No	(Continuous Shooting)
Yes	Yes	No	No	(Frame Composite)
Yes	Yes	Yes	Yes	AF (Standard)
Yes	Yes	Yes	Yes	(Macro)
Yes	Yes	Yes	Yes	(Infinity)
Yes	Yes	Yes	Yes	PF (Pan Focus)
Yes	Yes	Yes	Yes	MF (Manual Focus)
Yes	No*17	No*16	No*13	Recorded Pixels
Yes	Yes	Yes	Yes	Quality Level
No*10	Yes	Yes	Yes	White Balance
Yes	Yes	Yes	Yes	Focusing Area
No*2, 3	Yes*3	Yes*3	Yes*3	AE Metering
Yes	No*9	Yes	Yes	Sensitivity
Yes	Yes	Yes	Yes	EV Compensation
Yes	No	Yes	No	Digital Zoom
Yes	Yes	Yes	Yes	Instant Review
Yes	Yes	Yes	Yes	Memory
No	Yes	Yes	Yes	Sharpness
No	Yes	Yes	Yes	Saturation
No	Yes	Yes	Yes	Contrast
Yes	Yes	Yes	Yes	Date Imprint

*11 Fixed at (Multiple)

*12 (Automatic Tracking AF) is not available

*13 Stitched photos are fixed at (however, the first frame uses)

*14 Fixed at (Automatic Tracking AF)

*15 Fixed at Auto (Sensitivity 64 - 800)

*16 Fixed at for the first frame

*17 Fixed at

Optional Accessories

A number of dedicated accessories are available for this camera. Products marked with an asterisk (*) are the same as those supplied with the camera.

- **Power supply**

- Rechargeable lithium-ion battery D-LI78 (*)**

- Battery charger kit K-BC78 (*)**

- (Battery charger D-BC78, AC plug cord)

- AC adapter kit K-AC78**

- (AC adapter D-AC64, DC coupler D-DC78, AC plug cord)

- The battery charger and AC plug cord are only sold as a set.

- **Cable**

- USB cable I-USB7 (*)**

- AV cable I-AVC7 (*)**

- **Strap**

- O-ST51 (*)**

- O-ST24** Genuine leather strap

- O-ST8** Silver chain strap

- O-ST30** Waterproof strap

- **Camera case**

- O-CC78**

Messages

Messages such as the following may appear on the display during camera operation.

Message	Description
Battery depleted	The battery is exhausted. Charge the battery using the battery charger. (p.22)
Memory card full	The SD Memory Card is full and no more images can be saved. Insert a new SD Memory Card or delete unwanted images. (p.28, p.128) Change the quality level or recorded pixels of recorded images and try again. (p.136)
Memory card error	Shooting and playback are impossible due to a problem with the SD Memory Card. You may be able to display or copy the images on the card using a PC.
Card not formatted	The SD Memory Card you have inserted is unformatted or has been formatted on a computer or other device and is not compatible with this camera. Format the SD Memory Card in the camera. (p.162)
Card locked	The SD Memory Card is write-protected. (p.30)
Compression error	This message occurs when the camera fails to compress an image. Change the quality level or recorded pixels of the image and try shooting or saving it again.
No image/sound	There are no image/sound files on the SD Memory Card.
Movie recording stopped	This message appears when the internal temperature of the camera has exceeded normal operating limits while recording a movie.
Deleting	This message appears when deleting an image or sound file.
Camera cannot play this image and sound	You are trying to play back an image or sound in a format not supported by this camera. You may be able to play it back on another brand of camera or on your computer.
Image folder could not be created	The largest file number (9999) has been assigned to an image in the largest folder number (999) and no more images can be saved. Insert a new SD Memory Card or format the card. (p.162)
Protected	The image or sound file you are trying to delete is protected.

Message	Description
Data being recorded	This message appears when you try to switch to  mode while an image is still being recorded, or when the protect setting or DPOF setting is being changed. It disappears after the image is recorded or the setting is changed.
Data being processed	This message appears when the camera takes more than five seconds to display an image due to image processing, or when the SD Memory Card or built-in memory is being formatted.
Built-in memory full	Displayed if the built-in memory is full when saving a file.
No image to be processed	Displayed when there are no image or sound files.
This image/sound cannot be processed	Displayed for files that cannot be processed.
No card in the camera	Displayed when no SD card is inserted.
The built-in memory is not enough to copy images/sounds	Displayed when there is insufficient built-in memory to perform copying.
Cannot process correctly	Displayed when Red-eye Compensation processing fails.
Display image/sound from built-in memory	Displayed when the camera enters built-in memory display.
Green mode must be canceled to use this function.	Displayed when you try to use a function not supported by the Green Mode.









Messages such as the following may appear on the display when using the PictBridge function.

Message	Description
Low paper level in the printer	The paper level of the printer is low.
No paper in the printer	There is no paper in the printer.
Paper stuck in the printer	The paper is stuck in the printer.
Low ink level in the printer	The ink level of the printer is low.
No ink in the printer	There is no ink in the printer.
Printer error	An error message has been sent from the printer.
Data error	A data error message has been sent from the printer.
Connection error Check printer	Displayed when a PictBridge connection fails.
Printing now	Displayed when printing is being executed.

Message	Description
Printing is completed. Continue printing?	Displayed when printing completes.
Print Canceled	Displayed when printing is canceled.
No image to be processed	Displayed when there are no images to print.
Wrong DPOF setting	Displayed when DPOF printing cannot be performed.

Troubleshooting

Problem	Cause	Remedy
The camera will not turn on	The battery is not installed	Check if a battery is installed. If not, install a battery.
	The battery is installed incorrectly	Check orientation of the battery. Reinsert the battery according to the ⊕ ⊖ symbols in the battery compartment. (p.23)
	The battery is exhausted	Charge the battery.
No image appears on the display	The camera is connected to a PC	The display is off when the camera is connected to a computer.
	The camera is connected to a TV	The display is off when the camera is connected to a TV.
The display is hard to see	The brightness level of the display is set too dark	Adjust the brightness level in [Brightness Level] in the [Setting] menu. (p.173)
	Power Saving function is on	When the Power Saving function is on, the display automatically darkens after a certain amount of time. Press a button to return to the normal brightness level. Select [Off] in [Power Saving] in the [Setting] menu to turn the Power Saving function off. (p.174)
The shutter will not release	The flash is charging	Pictures cannot be taken while the flash is charging. Wait until charging is finished.
	There is no available space on the SD Memory Card or in the built-in memory	Insert an SD Memory Card with available space or delete unwanted images. (p.28, 128)
	Recording	Wait until recording is finished.
The picture is dark	The subject is too far away in a dark environment, such as a night scene	The picture becomes dark if the subject is too far away. Take pictures within the specified flash range.

Problem	Cause	Remedy
The subject is not in focus	The subject is difficult to focus on with autofocus	The camera may have difficulty in focusing on such subjects as: low contrast subjects (a white wall, a blue sky, etc.), dark subjects, finely-patterned objects, rapidly-moving objects. It is also difficult to get proper focus when shooting through a window or a net. Try shooting using the focus lock (p.41), or Manual Focus (p.88).
	The subject is not in the focusing area	Locate the desired subject in the focus frame (focusing area) in the center of the display. If it is difficult to do so, first lock the focus on the desired subject (focus lock), and then move the camera to recompose.
	The subject is too close	Set the focus mode to  . (p.87)
	The focus mode is set to 	Normal pictures will be out of focus if taken with the focus mode set to  .
The flash does not discharge	The flash mode is set to  (flash off)	Set to Auto or  (Flash On). (p.89)
	The drive mode is set to 	The flash does not discharge in these modes.
	The focus mode is set to 	
The shooting mode is set to  or 		
The USB connection with a personal computer does not function properly	The USB connection setting of the camera is set to [PictBridge]	Set the USB connection setting to [PC]. (p.171)
The USB connection with a printer does not function properly	The USB connection setting of the camera is set to [PC]	Set the USB connection setting to [PictBridge]. (p.152)

Very occasionally, static electricity may cause camera malfunction. In this case, remove the battery and install it again. If the camera is then working properly, normal condition is restored and you can continue using the camera.

Main Specifications



Type	Fully automatic compact digital still camera with built-in zoom lens		
Number of Effective Pixels	Approx. 8.0 megapixels		
Image Sensor	1/2.35 inch CCD		
Number of Recorded Pixels	Still	8M (3264×2448 pixels), 5M (2592×1944 pixels) 4M (2304×1728 pixels), 3M (2048×1536 pixels) 2M (1600×1200 pixels), 1024 (1024×768 pixels) 640 (640×480 pixels)	
		* Fixed at 5M (2592×1944) in Digital SR mode. * Fixed at 5M (2592×1944) in Digital Wide mode.	
	Movie	640 (640×480 pixels), 320 (320×240 pixels)	
Sensitivity (Standard Output Sensitivity)	Auto, Fixed (ISO 64 - 6400)	* The sensitivity is fixed at Auto (64-6400) in the Digital SR (Shake Reduction).	
File Format	Still	JPEG (Exif 2.2), DCF 2.0, DPOF, PictBridge, PRINT Image Matching III	
	Movie	AVI (Motion JPEG), approx. 30fps/15fps, PCM system, monaural sound, full color/sepia/black and white, Movie SR (Movie Shake Reduction)	
	Sound	Voice memo, voice recording: WAVE (PCM) system, monaural	
Quality Level	Still	★★★ "Best", ★★ "Better", ★ "Good"	
	Movie	★★★ "Best", ★★ "Better", ★ "Good"	
Storage Media	Built-in memory (approx. 51.1 MB), SD Memory Card, SDHC Memory Card		

Approximate Image Storage Capacity and Recording Time



	★★★ (Best)		★★ (Better)		★ (Good)	
	Built-in Memory	512 MB	Built-in Memory	512 MB	Built-in Memory	512 MB
8M 3264×2448	13 pictures	121 pictures	25 pictures	232 pictures	38 pictures	351 pictures
5M 2592×1944	20 pictures	188 pictures	38 pictures	355 pictures	54 pictures	503 pictures
4M 2304×1728	25 pictures	236 pictures	49 pictures	457 pictures	69 pictures	643 pictures
3M 2048×1536	31 pictures	293 pictures	61 pictures	570 pictures	88 pictures	816 pictures
2M 1600×1200	51 pictures	472 pictures	83 pictures	774 pictures	121 pictures	1119 pictures
1024 1024× 768	96 pictures	888 pictures	155 pictures	1439 pictures	192 pictures	1777 pictures
640 640× 480	192 pictures	1777 pictures	297 pictures	2747 pictures	363 pictures	3358 pictures

- The image storage capacity is for reference only. The actual image storage capacity may vary depending on the SD Memory Card and the subject.

Movie/Sound

		30fps		15fps		Sound	
		Built-in Memory	512 MB	Built-in Memory	512 MB	Built-in Memory	512 MB
 640×480	★★★	48 sec.	7 min. 31 sec.	1 min. 36 sec.	14 min. 48 sec.	41 min. 17 sec.	6 hr. 14 min. 15 sec.
	★★	1 min. 5 sec.	10 min. 4 sec.	2 min. 10 sec.	20 min. 8 sec.		
	★	1 min. 39 sec.	15 min. 15 sec.	3 min. 12 sec.	29 min. 37 sec.		
 320×240	★★★	1 min. 17 sec.	11 min. 59 sec.	2 min. 28 sec.	22 min. 53 sec.		
	★★	1 min. 45 sec.	16 min. 14 sec.	3 min. 24 sec.	31 min. 28 sec.		
	★	2 min. 28 sec.	22 min. 53 sec.	4 min. 57 sec.	45 min. 47 sec.		

The recording time is for reference only. The actual recording time may vary depending on the SD Memory Card and the subject.

White Balance	Auto, Daylight, Shade, Tungsten Light, Fluorescent Light, Manual	
Lens	Focal Length	6.3 mm - 31.5 mm (approx. 36 mm - 180 mm in 35mm equivalent focal length)
	Aperture	F3.5 (W) - F5.6 (T)
	Lens Composition	8 elements in 6 groups (4 aspherical elements)
	Zoom Type	Electrically driven
Optical Zoom	5×	
Intelligent Zoom	Approx. 6.3× at  (2592×1944), Approx. 25.5× at  (640×480) (when combined with 5× optical zoom)	
Digital Zoom	Max. 5.1× (combines with 5× optical zoom to give zoom magnification equivalent to 25.5×)	
Motion Blur Reduction	Still	Hi-sensitivity shake reduction mode (Digital SR)
	Movie	Movie shake reduction (Movie SR)
Display	2.5 inch LCD, approx. 230,000 dots, Wide viewing angle	
Playback modes	Single-frame, 9-frame Index, Enlargement (max. 8×, scrollable), Face Close-up Playback, Folder Display, Calendar Display, Sound Playback, Histogram Display, Bright/Dark Portion Display, Deleting Selected Images, Digital SR, Slideshow, Resize, Cropping, Image&Sound Copy, Image Rotation, Digital Filter (Color Filter (11 kinds), Digital Filter, Brightness Filter), Movie Edit, Frame Composite, Red-eye Compensation, Voice Memo, Protect, DPOF, Image Recovery, Start-up Image Setting	
Focus Modes	Autofocus, Macro, Infinity, Pan Focus, Manual Focus	

Focus	Type	TTL contrast detection system by sensor 9-point autofocus (multiple/spot/automatic tracking AF changeable)
	Focus range (From lens face)	Normal : 0.4 m - ∞ (Wide-angle) 0.9 m - ∞ (Telephoto) Macro : 0.1 m - 0.5 m (Wide-angle) 0.6 m - 1.0 m (Telephoto) * It is possible to switch to Pan Focus, Infinity and Manual Focus. * Face Recognition AF is available only while the camera recognizes the subject's face.
	Focus Lock	By half-pressing shutter release button
Exposure control	Metering System	Multi-segment metering, Center-weighted metering, Spot metering
	Exposure Compensation	±2 EV (can be set in 1/3 EV steps)
Face Priority	Recognition of max. 15 people's faces, Smile Capture	
Scene modes	Auto Picture, Green, Program, Night Scene, Movie, Voice Recording, Landscape, Flower, Natural Skin Tone, Portrait, Digital SR (Blur Reduction), Surf & Snow, Sport, Pet, Kids, Food, Digital Panorama, Digital Wide * Face Recognition AE is available only while the camera recognizes the subject's face.	
Digital Filters	B&W, Sepia, Red, Pink, Purple, Blue, Green, Yellow, Soft, Color extraction (Red, Green, Blue), Brightness	
Movie	Continuous Recording Time	Approx. 1 second - until built-in memory or SD Memory Card is full (however, maximum size is limited to 2 GB)
Shutter Speed	1/2000 sec. - 1/4 sec., max. 4 sec. (Night Scene mode)	
Built-in Flash	Modes	Auto, Flash Off, Flash On, Auto + Red-eye, Flash On + Red-eye, Soft Flash
	Flash Range	Wide-angle: approx. 0.2 m - 4.4 m (approx. 0.66 ft - 14.44 ft) (Sensitivity: in Auto condition) Telephoto: approx. 0.6 m - 2.8 m (approx. 1.97 ft - 9.19 ft) (Sensitivity: in Auto condition)
Drive Modes	Single-frame, Self-timer (approx. 10 sec., approx. 2 sec.), Continuous, Frame Composite	
Self-timer	Electronic control type, control time: Approx. 10 sec., 2 sec.	
Time Function	World Time	75 cities (28 time zones)
Power Source	Rechargeable lithium-ion battery D-LI78, AC adapter kit (optional)	

Battery Life	Number of Recordable Images approx. 210 pictures	* Recording capacity shows approximate number of shots recorded during CIPA-compliant testing (with display on, flash used for 50% of the shots, and 23 degrees centigrade). Actual performance may vary according to operating conditions.
	Playback Time approx. 240 min.	* According to the result of in-house testing. Actual time may differ depending on usage conditions.
	Movie Recording Time approx. 70 min.	
	Sound Recording Time approx. 300 min.	
Interfaces	USB 2.0 (high-speed compatible) /PC/AV terminal	
Video Output	NTSC/PAL (monaural)	
PictBridge	Printer	PictBridge-compatible printer
	Print Modes	Print One, Print All, DPOF AUTOPRINT
	Paper Size	Card, L, 2L, Postcard, 100 mm×150 mm, 4"×6", 8"×10", Letter, 11"×17", A4, A3, printer setting
	Paper Type	★★★, ★★, ★, printer setting
	Quality	★★★, ★★, ★, printer setting
	Border Status	With/without, printer setting
Dimensions	Approx. 95 (W) × 55 (H) × 23.5 (D) mm (excluding operating or protruding parts)	
Weight	Approx. 115 g (excluding battery and SD Memory Card) Approx. 130 g (including battery and SD Memory Card)	
Accessories	Rechargeable lithium-ion battery, battery charger, AC plug cord, USB cable, AV cable, software (CD-ROM), strap, Operating Manual, PC Connection Manual, Quick Guide	

WARRANTY POLICY

All PENTAX cameras purchased through authorized bona fide photographic distribution channels are guaranteed against defects of material or workmanship for a period of twelve months from date of purchase. Service will be rendered, and defective parts will be replaced without cost to you within that period, provided the equipment does not show evidence of impact, sand or liquid damage, mishandling, tampering, battery or chemical corrosion, operation contrary to operating instructions, or modification by an unauthorized repair shop. The manufacturer or its authorized representatives shall not be liable for any repair or alterations except those made with its written consent and shall not be liable for damages from delay or loss of use or from other indirect or consequential damages of any kind, whether caused by defective material or workmanship or otherwise; and it is expressly agreed that the liability of the manufacturer or its representatives under all guarantees or warranties, whether expressed or implied, is strictly limited to the replacement of parts as hereinbefore provided. No refunds will be made on repairs by non-authorized PENTAX service facilities.

Procedure During 12-month Warranty Period

Any PENTAX which proves defective during the 12-month warranty period should be returned to the dealer from whom you purchased the equipment or to the manufacturer. If there is no representative of the manufacturer in your country, send the equipment to the manufacturer, with postage prepaid. In this case, it will take a considerable length of time before the equipment can be returned to you owing to the complicated customs procedures required. If the equipment is covered by warranty, repairs will be made and parts replaced free of charge, and the equipment will be returned to you upon completion of servicing. If the equipment is not covered by warranty, regular charges of the manufacturer or of its representatives will apply. Shipping charges are to be borne by the owner. If your PENTAX was purchased outside of the country where you wish to have it serviced during the warranty period, regular handling and servicing fees may be charged by the manufacturer's representatives in that country. Notwithstanding this, your PENTAX returned to the manufacturer will be serviced free of charge according to this procedure and warranty policy. In any case, however, shipping charges and customs clearance fees to be borne by the sender. To prove the date of your purchase when required, please keep the receipt or bills covering the purchase of your equipment for at least a year. Before sending your equipment for servicing, please make sure that you are sending it to the manufacturer's authorized representatives or their approved repair shops, unless you are sending it directly to the manufacturer. Always obtain a quotation for the service charge, and only after you accept the quoted service charge, instruct the service station to proceed with the servicing.

- This warranty policy does not affect the customer's statutory rights.
- The local warranty policies available from PENTAX distributors in some countries can supersede this warranty policy. Therefore, we recommend that you review the warranty card supplied with your product at the time of purchase, or contact the PENTAX distributor in your country for more information and to receive a copy of the warranty policy.



The CE Mark is a Directive conformity mark of the European Union.

For customers in USA

STATEMENT OF FCC COMPLIANCE

This device complies with Part 15 of the FCC Rules. Operation is subject to the following two conditions: (1) This device may not cause harmful interference, and (2) this device must accept any interference received, including interference that may cause undesired operation.

Changes or modifications not approved by the party responsible for compliance could void the user's authority to operate the equipment.

This equipment has been tested and found to comply with the limits for a Class B digital device, pursuant to part 15 of the FCC Rules.

These limits are designed to provide reasonable protection against harmful interference in a residential installation. This equipment generates, uses and can radiate frequency energy and, if not installed and used in accordance with the instructions, may cause harmful interference to radio communications. However, there is no guarantee that interference will not occur in a particular installation.

If this equipment does cause harmful interference to radio or television reception, which can be determined by turning the equipment off and on, the user is encouraged to try to correct the interference by one or more of the following measures:

- Reorient or relocate the receiving antenna.
Increase the separation between the equipment and receiver.
Connect the equipment into an outlet on a circuit different from that to which the receiver is connected.
- * Consult the dealer or an experienced radio/TV technician for help.

For customers in Canada

This Class B digital apparatus complies with Canadian ICES-003.

9

Pour les utilisateurs au Canada

Cet appareil numérique de la classe B est conforme à la norme NMB-003 du Canada.

FOR CALIFORNIA, U.S.A. ONLY

Perchlorate Material-special handling may apply. The lithium battery used in this camera contains perchlorate material, which may require special handling. See www.dtsc.ca.gov/hazardouswaste/perchlorate

Declaration of Conformity

According to 47CFR, Parts 2 and 15 for
Class B Personal Computers and Peripherals

We: PENTAX Imaging Company
A Division of PENTAX of America, Inc.

Located at: 600 12th Street, Suite 300
Golden, Colorado 80401 U.S.A.
Phone: 303-799-8000 FAX: 303-790-1131

Declare under sole responsibility that the product identified herein complies with 47CFR Parts 2 and 15 of the FCC rules as a Class B digital device. Each product marketed is identical to the representative unit tested and found to be compliant with the standards. Records maintained continue to reflect the equipment being produced can be expected to be within the variation accepted, due to quantity production and testing on the statistical basis as required by 47CFR §2.909. Operation is subject to the following two conditions: (1) This device may not cause harmful interference, and (2) This device must accept any interference received, including interference that may cause undesired operation. The above named party is responsible for ensuring that the equipment complies with the standards of 47CFR §15.101 to §15.109.

Product Name: PENTAX Digital Still Camera

Model Number: Optio M50

Contact person: Customer Service Manager

Date and Place: January, 2008, Colorado

Information on disposal for users



1. In the European Union

If your product is marked with this symbol, it means that used electrical/electronic products should not be mixed with general household waste. There exists a separate collection system for these products.

Used electric/electronic equipment must be treated separately and in accordance with legislation that requires proper treatment, recovery and recycling of these products. Following the implementation by member states, private households within the EU states may return their used electrical/electronic equipments to designated collection facilities free of charge*. In some countries your local retailer may also take back your old product free of charge if you purchase a similar new one.

*Please contact your local authority for further details.

By disposing of this product correctly you will help ensure that the waste undergoes the necessary treatment, recovery and recycling and thus prevent potential negative effects on the environment and human health which could otherwise arise due to inappropriate waste handling.

2. In other countries outside the EU

If you wish to discard this product, please contact your local authorities and ask for the correct method of disposal.

For Switzerland: Used electrical/electronic equipment can be returned free of charge to the dealer, even when you don't purchase a new product. Further collection facilities are listed on the home page of www.swico.ch or www.sens.ch.

Memo

Symbols

[Rec.Mode] menu	51
mode	10, 115
button	44, 46
button	44, 47
mode	10, 115
[Setting] menu	52
Green Mode	63
Green Button ...	45, 47, 57
Delete	43, 128
Tele	78
Wide	78
Magnify	118
Nine-image display	116
Self-timer	76
Continuous Shooting	77
Auto Picture	54, 61
Program	54, 62
Night Scene	54, 65
Movie	54
Voice Recording ...	54, 157
Frame Composite	66
Landscape	54
Flower	54
Portrait	54
Surf & Snow	54
Sport	54
Pet	54, 70
Digital SR (Blur Reduction)	54, 65
Digital SR (Camera Shake Reduction)	122
Kids	54
Food	55
Natural Skin Tone	54
Digital Panorama	74

Digital Wide	81
--------------------	----

A

AC adapter	26
Adding sound (Voice Memo)	160
AE metering	96
Auto + Red-eye 	89
Auto AWB	94
Auto Power Off	175
Auto 	89
Autofocus conditions	100
AV equipment	126

B

B&W	113
Basic mode	63
Battery level indicator	25
Bright portions	19
Brightness Filter	143
Built-in memory display	115

C

Calendar display	117
Calling up menus	57
Camera shake	79, 85
Capture Mode Palette	53
Center-weighted metering 	96
Changing volume	159, 163
Charging a battery	22
Checking the Memory Card	34
Color Mode	113
Computer	171
Connecting to a printer	152
Continuous Shooting 	77
Contrast	104

Copy 139
Cropping 138

D

Dark portions 19
Date and time 38, 165
Date Imprint 105
Daylight ☀ 94
Daylight saving time 38
Default setting 36, 181
Delete 🗑 43, 128
Deleting sounds 129
Digital Filter 141
Digital Panorama 📷 74
Digital SR
(Blur Reduction) 54, 65
Digital SR
(Camera Shake
Reduction) 122
Digital Wide 81
Digital Zoom 80
Display brightness 173
Dividing movies 148
DPOF printing 156
DPOF settings 149

F

Face close-up playback ... 119
Face Recognition AE 56
Face Recognition AF 56
File # 106
Flash Off 🔌 89
Flash On + Red-eye 📷 89
Flash On ⚡ 89
Fluores. Light ☀ 94
Focus Mode 87
Focusing 87
Focusing Area 100
Folder display 117
Format 162
Four-way controller 45, 47

Frame Composite 66, 145
Frame Rate 32, 112

G

Green Button 📺 ... 45, 47, 57
Green Mode 🟢 63
Guide display 177

H

Histogram 86
Hometown 38

I

Infinity ▲ 87
Installing a battery 23
Instant Review 41, 101

L

Language 36, 169

M

Macro 🌸 87
Magnify 🔍 118
Manual Focus **MF** 87
Manual 📷 94
Memory 106
MENU button 45, 47
Movie SR (Movie Shake
Reduction) Function 114
Multi-segment
metering 📺 96

N

Nine-image display 📷 116
NTSC 172
Number of pixels 91
Number of Recordable
Images 32

O

OK/DISPLAY button ... 45, 47
Optional accessory 188

P

PAL	172
Pan Focus PF	87
Panoramic Pictures	74
Photo processing lab	149
PictBridge	152
Playback	42, 115, 125, 159, 161
Playback Mode	35
Playback Mode Palette	59
Playing back movies	125
Playing back sounds	159
Power Saving	174
Power switch	34, 44, 46
Press fully (shutter release button)	41
Press halfway (shutter release button)	41
Printing	152
Protect 	134

Q





Quality Level	31, 93
Quick Zoom	176

R

Recorded Pixels	31, 32, 91, 110
Recording movies	108
Recording sounds	157
Recovering images	133
Red-eye Compensation ...	144
Red-eye reduction 	89, 90
Resetting settings	178
Resize	136
Rotating	43

S

Saturation	103
------------------	-----

Saving as still picture (movie)	147
Saving settings	106
SD Memory Card	28
Select time	168
Self-timer 	76
Sensitivity	98
Sepia	113
Setting the exposure	84
Shade 	94
Sharpness	102
Shooting information	85, 121
Shooting Mode	53
Shutter release button	41, 44, 46
Slideshow	123
Soft Flash ^{SOFT} 	89
Sound settings	163
Sound types	164
Spot AE metering 	96
Standard AF	87
Start-up screen	179
Strap	21

T

Tungsten Light 	94
TV	126

U

USB connection mode	171
---------------------------	-----

V

Video output format	172
Voice Memo	160

W

White Balance	94
World Time	167

Z

Zoom button 44, 46

Zoom  78

Memo

Memo

PENTAX Corporation	2-36-9, Maeno-cho, Itabashi-ku, Tokyo 174-8639, JAPAN (http://www.pentax.co.jp/)
PENTAX Europe GmbH (European Headquarters)	Julius-Vosseler-Strasse 104, 22527 Hamburg, GERMANY (HQ - http://www.pentaxeurope.com) (Germany - http://www.pentax.de)
PENTAX U.K. Limited	PENTAX House, Heron Drive, Langley, Slough, Berks SL3 8PN, U.K. (http://www.pentax.co.uk)
PENTAX France S.A.S.	112 Quai de Bezons, B.P. 204, 95106 Argenteuil Cedex, France (http://www.pentax.fr)
PENTAX (Schweiz) AG	Widenholzstrasse 1, 8304 Wallisellen, Postfach 367, 8305 Dietlikon, SWITZERLAND (http://www.pentax.ch)
PENTAX Italia S.r.l.	Via Dione Cassio 15, 20138 Milano, ITALY (http://www.pentaxitalia.it)
PENTAX Scandinavia AB	P.O. Box 650, 75127 Uppsala, SWEDEN (http://www.pentax.se)
PENTAX Imaging Company A Division of PENTAX of America, Inc.	(Headquarters) 600 12th Street, Suite 300 Golden, Colorado 80401, U.S.A. (PENTAX Service Department) 12000 Zuni Street, Suite 100B Westminster, Colorado 80234, U.S.A. (http://www.pentaximaging.com)
PENTAX Canada Inc.	1770 Argenta Road Mississauga, Ontario L5N 3S7, CANADA (http://www.pentax.ca)
PENTAX Trading (SHANGHAI) Limited	23D, Jun Yao International Plaza, 789 Zhaojiabang Road, Xu Hui District, Shanghai, 200032 China (http://www.pentax.com.cn)



for your
precious moments

<http://www.pentax.co.jp/english>

- Printed on recycled paper.
- Specifications and external dimensions are subject to change without notice.