

PENTAX



Digital Camera

Optio W60

Operating Manual



To ensure the best performance from your camera, please read the Operating Manual before using the camera.

Thank you for purchasing this PENTAX Digital Camera.

Please read this manual before using the camera in order to get the most out of all the features and functions. Keep this manual safe, as it can be a valuable tool in helping you to understand all the camera capabilities.

Regarding copyrights

Images taken using the PENTAX Digital Camera that are for anything other than personal enjoyment cannot be used without permission according to the rights as specified in the Copyright Act. Please take care, as there are cases where limitations are placed on taking pictures even for personal enjoyment during demonstrations, performances or of items on display. Images taken with the purpose of obtaining copyrights also cannot be used outside the scope of use of the copyright as laid out in the Copyright Act, and care should be taken here also.

To users of this camera

- There is a possibility that recorded data may be erased or that the camera may not function correctly when used in surroundings such as installations generating strong electromagnetic radiation or magnetic fields.
- The liquid crystal panel used in the display is manufactured using extremely high precision technology. Although the level of functioning pixels is 99.99% or better, you should be aware that 0.01% or fewer of the pixels may not illuminate or may illuminate when they should not. However, this has no effect on the recorded image.
- There is a possibility that the illustrations and the display screen in this manual are different from the actual product.
- In this manual, both an SD Memory Card and an SDHC Memory Card are referred to as SD Memory Cards hereafter.
- In this manual, the generic term "computer(s)" refers to either a Windows PC or a Macintosh hereafter.

Regarding trademarks

- PENTAX and Optio are trademarks of HOYA CORPORATION.
- SDHC logo () is trademark.
- This product supports PRINT Image Matching III. PRINT Image Matching enabled digital still cameras, printers and software help photographers to produce images more faithful to their intentions. Some functions are not available on printers that are not PRINT Image Matching III compliant. Copyright 2001 Seiko Epson Corporation. All Rights Reserved. PRINT Image Matching is a trademark of Seiko Epson Corporation. The PRINT Image Matching logo is a trademark of Seiko Epson Corporation.
- All other brands or product names are trademarks or registered trademarks of their respective companies.

Regarding PictBridge

PictBridge allows the user to connect the printer and digital camera directly, using the unified standard for the direct printout of images. You can print images directly from the camera through a few simple operations.

Regarding Product Registration

In order to better serve you, we request that you complete the product registration, which can be found on the CD-ROM supplied with the camera or the PENTAX website. Thank you for your cooperation.
Refer to the PC Connection Manual (bottom right of the front side) for more information.

USING YOUR CAMERA SAFELY

We have paid close attention to the safety of this product. When using this product, we request your special attention regarding items marked with the following symbols.



Warning

This symbol indicates that violating this item could cause serious personal injuries.



Caution

This symbol indicates that violating this item could cause minor or medium personal injuries, or material losses.

About the Camera



Warning

- Do not attempt to take the camera apart or remodel the camera. High voltages are present within the camera, and there is therefore a danger of electric shocks if the camera is taken apart.
- If the inside of the camera should become exposed as a result of, for example, the camera being dropped, please do not under any circumstances touch such exposed portions, as there is a danger of receiving an electric shock.
- To avoid the risk of it being swallowed by mistake, keep the SD Memory Card out of the reach of small children. Seek medical attention immediately if a card is accidentally swallowed.
- Wrapping the strap of the camera around your neck is also dangerous. Please take care that small children do not hang the strap around their necks.
- Use an AC adapter that is of the power and voltage specified for exclusive use with this product. The use of an AC adapter other than that specified exclusively for use with this product may cause fire or electric shocks.
- If the camera emits smoke or a strange smell, or in the event of any other irregularity, stop using the camera immediately, remove the battery and contact your nearest PENTAX Service Center. Continued use of the camera may result in fire or electric shock.

Caution

- Do not charge any batteries other than rechargeable lithium-ion battery D-LI78. The battery could explode or catch fire.
- Do not place your finger on the flash when it is discharging as there is a risk of burns.
- Do not discharge the flash while it is touching your clothing as there is a risk of discoloring.
- If any leakage from the battery should come in contact with your eyes, it may cause a loss of sight. Flush your eyes with clean water and get medical attention immediately. Do not rub them.
- If any leakage from the battery should come in contact with skin or clothes, it may cause irritation to the skin. Wash the affected areas thoroughly with water.
- Precautions for D-LI78 Battery Usage:
 - USE SPECIFIED CHARGER ONLY.
 - DO NOT INCINERATE.
 - DO NOT DISASSEMBLE.
 - DO NOT SHORT CIRCUIT.
 - DO NOT EXPOSE TO HIGH TEMP. (140°F / 60°C)
- Remove the battery from the camera immediately if it becomes hot or begins to smoke. Be careful not to burn yourself during removal.
- Some portions of the camera heat up during use, so please take care, as there is a risk of low temperature burns if such portions are held for long periods of time.
- Should the LCD be damaged, be careful of glass fragments. Also, be careful not to allow the liquid crystal to get on your skin or in your eyes or in your mouth.
- Depending on your inherent factors or physical condition, the use of the camera may cause itching, rashes or blisters. In case of any abnormality, stop using the camera and get medical attention immediately.

About the Battery Charger and the AC Adapter

Warning

- Do not use the product at a voltage other than the specified voltage. Use with a power source or voltage other than that designed can cause a fire or electrical shock. The specified voltage is 100-240V AC.
- Do not disassemble or modify the product. This can cause a fire or electrical shock.

- If the generation of smoke or strange odor from the product or other abnormality occurs, immediately discontinue using and consult a PENTAX Service Center. Continuing to use the product can cause a fire or electrical shock.
- If water should happen to get inside the product, consult a PENTAX Service Center. Continuing to use the product can cause a fire or electrical shock.
- If thunder storm should be present during use of the battery charger or AC adapter, unplug the power cord and discontinue use. Continuing to use the product can cause damage to the equipment, fire or electrical shock.
- Wipe off the plug of the power cord if it should become covered with dust. This can cause a fire.

 **Caution**

- Do not place heavy objects on the AC plug cord, allow heavy objects to drop onto it or allow the AC plug cord to become damaged due to excessive bending. If the AC plug cord becomes damaged, consult a PENTAX Service Center.
- Do not short or touch the output terminals of the product while it is still plugged in.
- Do not plug in the AC plug cord with wet hands. This can cause an electrical shock.
- Do not subject the product to strong impacts or allow it to drop onto a hard surface. This can cause a malfunction.
- Do not use the battery charger to charge batteries other than rechargeable lithium-ion battery D-LI78. This can cause overheating or malfunctions.
- To reduce the risk of hazards, use only CSA/UL Certified power supply cord set, cord is Type SPT-2 or heavier, minimum NO.18 AWG copper, one end with a molded-on male attachment plug cap (with a specified NEMA configuration), and the other is provided with a molded-on female connector body (with a specified IEC nonindustrial type configuration) or the equivalent.

Care to be Taken During Handling

- When traveling, take the Worldwide Service Network listing that is included in the package. This will be useful if you experience problems abroad.
- When the camera has not been used for a long time, confirm that it is still working properly, particularly prior to taking important pictures (such as at a wedding or during traveling). Contents of the recording cannot be guaranteed if recording, playback or transferring your data to a computer, etc. is not possible due to a malfunction of your camera or recording media (SD Memory Card), etc.
- The lens on this camera is not interchangeable. The lens is not removable.
- Do not clean the product with organic solvents such as thinner, alcohol or benzene.
- Places of high temperature and humidity should be avoided. Particular care should be taken regarding vehicles, which can become very hot inside.
- Storing the camera where pesticides and chemicals are handled should be avoided. Remove the camera from its case and store in a well-ventilated place to prevent the camera from becoming moldy during storage.
- Ensure that the camera is not subjected to substantial vibrations, shocks or pressure as this may cause damage, malfunction, or a loss in waterproof performance. Place the camera on a cushion for protection when the camera is subjected to the vibrations of a motorbike, car, ship, etc. If the camera is subjected to substantial vibrations, shocks or pressure, take your camera to your nearest PENTAX Service Center and have it checked.
- The temperature range in which the camera can be used is -10°C to 40°C (14°F to 104°F).
- The liquid crystal display will become black at a high temperature but will return to normal when normal temperatures are returned to.
- The response speed of the liquid crystal display becomes slow at low temperatures. This is due to the properties of the liquid crystal and is not a fault.
- Periodic checks are recommended every 1 to 2 years in order to maintain high performance.
- If the camera is subjected to rapid temperature changes, condensation may form on the inside and outside of the camera. Therefore put the camera in a bag or plastic bag and take the camera out when the difference in temperature has subsided.



- Refer to “Precautions When Using an SD Memory Card” (p.33) regarding the SD Memory Card.
- Please note that commercially available recovery software may be able to read the data on an SD Memory Card even if the format or delete function of a camera or computer was used to delete the data. Please manage your camera memory at your own risk.
- Please do not press forcefully on the display. This could cause breakage or malfunction.
- Be careful not to sit down with the camera in your back pocket as this may damage the exterior of the camera or the display.
- When using a tripod with the camera, be careful not to overtighten the screw in the tripod socket on the camera.
- The AC plug cord supplied with the camera is for exclusive use with the battery charger D-BC78. Do not use it with any other equipment.
- Storing the battery fully charged may decrease the battery performance. Avoid storing it especially in high temperatures.
If the battery is left inserted and the camera is not used for a long time, the battery will over-discharge and shorten the battery’s service life.
- Charging the battery a day before use or on the day of use is recommended.

Waterproof and Dustproof Function



- This camera is provided with a waterproof/dustproof design complying with JIS waterproof grade 8 and JIS dustproof grade 5 (equivalent to IP58).
- To enhance the waterproof performance of the camera, the front of the lens is protected by glass. As any dirt or water on the glass will affect the quality of pictures taken, the glass should be kept clean at all times.
- Leaving the camera on the sand at the beach may cause the camera to exceed its operating temperature or cause the speaker or microphone to become blocked with sand.
- The camera will sink if dropped in water, so be sure to attach the strap and slip the strap over your wrist when using the camera in or near water.
- Be sure to check that the battery/card/terminal cover is securely locked before using the camera in an environment where it is likely to get wet or dirty, such as underwater or at the beach. Water, sand or dirt inside the camera may cause failure of the camera. Wipe off any water or dirt with a dry cloth as soon as possible after using the camera.

- Avoid opening the battery/card/terminal cover at the beach or by the sea. Wait until the camera is completely dry before changing the battery or the SD Memory Card. Avoid changing the battery or card where the camera is likely to get wet or dirty, and make sure that your hands are dry.
- If the camera is very dirty or after it has been used in the sea, make sure that it is turned off and the battery/card/terminal cover is firmly closed before rinsing it under running tap water or leaving it in a bowl of clean water for a short time (2 or 3 minutes).
- Avoid cleaning with agents such as soapy water, mild detergents, and alcohol as this may compromise the waterproof performance of the camera.
- Wipe off any dirt or sand on the waterproof packing or the packing contact surface. The camera waterproof function may be compromised by loose packing or cracks or dents in the packing or packing contact surface. If there is any such damage, contact your nearest PENTAX Service Center.
- To maintain the waterproof performance of the camera, you are recommended to change the waterproof packing once a year. Contact your nearest PENTAX Service Center regarding changing the packing. (A charge will be made.)
- Avoid subjecting the camera to substantial vibrations, shocks, or pressure as this may cause a loss in waterproof performance. If the camera is subjected to substantial vibrations, shocks or pressure, take your camera to your nearest PENTAX Service Center and have it checked.
- Avoid getting sunscreen or sun oil on the camera as it may cause discoloration of the surface. If any oil gets on the camera, wash it off immediately with warm water.
- The waterproof function does not apply to the camera accessories.

Contents

USING YOUR CAMERA SAFELY	1
Care to be Taken During Handling	4
Contents	7
Composition of the Operating Manual	13
Camera Features	14
Checking the Contents of the Package	18
Names of Parts	19
Names of Operating Parts	20
Monitor Indications	21
Getting Started	24
<hr/>	
Attaching the Strap	24
Powering the Camera	25
Charging the Battery	25
Installing the Battery	26
Using the AC Adapter	29
Installing the SD Memory Card	31
Recorded Pixels and Quality Level of Still Pictures	34
Recorded Pixels for Movies/Frame Rate	35
Turning the Camera On and Off	37
Playback Mode	38
Initial Settings	39
Setting the Display Language	39
Setting the Date and Time	41
Quick Start	43
<hr/>	
Taking Still Pictures	43
Playing Back Still Pictures	45
Playing Back Images	45
Playing Back the Previous or Next Image	45
Rotating the Displayed Image	46
Common Operations	47
<hr/>	
Understanding the Button Functions	47
 Mode	47
 Mode	49
Setting the Camera Functions	51
Setting with the Menus	51
Menu List	54
Setting the Shooting Mode	56

Setting the Face Recognition function	59
Setting Blink Detection	61
Using the Playback Function	62
Taking Pictures	64
Taking Pictures	64
Taking Pictures Automatically (Auto Picture Mode)	64
Setting The Functions (Program Mode)	65
Taking Pictures in the Basic Mode (Green Mode)	66
Taking Pictures of Dark Scenes (Night Scene/Digital SR (Blur Reduction)/Fireworks Mode)	68
Taking Underwater Pictures (Underwater Mode/Underwater Movie Mode)	69
Framing Your Pictures (Frame Composite)	71
Taking Pictures of People (Portrait/Night Scene Portrait Mode)	73
Zooming and Taking Pictures of People (Half-length Portrait Mode)	75
Taking Pictures of Your Pet (Pet Mode)	77
Taking Pictures of Children (Kids Mode)	79
Taking Pictures of Text (Text Mode)	81
Taking Panoramic Pictures (Digital Panorama Mode)	82
Using the Digital Wide Function (Digital Wide Mode)	84
Using the Self-timer	87
Taking a Series of Pictures (Continuous Shooting/High Speed Continuous Shooting Mode)....	88
Taking Pictures at a Set Interval (Interval Shoot)	90
Taking Pictures with Automatic Exposure Adjustment (Auto Bracket)	93
Using the Zoom	94
Setting the Exposure (EV Compensation)	97
Displaying Shooting Information in Capture Mode	98
Setting the Shooting Functions	100
Selecting the Focus Mode	100
Selecting the Flash Mode	102
Selecting the Recorded Pixels	104
Selecting the Quality Level	107
Adjusting the White Balance	108
Setting the AE Metering	110
Setting the Sensitivity	112
Setting the Autofocus Conditions	115
Setting Interval Shoot	117
Setting the Instant Review Time (Instant Review)	120
Setting the Green Button	121
Setting the Image Sharpness (Sharpness)	124

Setting the Color Saturation (Saturation).....	125
Setting the Image Contrast (Contrast).....	126
Setting the Date Imprint Function	127
Saving the Settings (Memory)	128
Recording Movies	130
Recording a Movie.....	130
Selecting the Recorded Pixels and Frame Rate for Movies	133
Recording Movies in Black and White or Sepia Tones (Color Mode).....	135
Setting the Movie SR (Movie Shake Reduction) Function.....	136
Recording a Movie from Pictures Taken at a Set Interval (Interval Movie).....	137
Selecting the Focusing Method for Recording Movies	140
Setting the Optical Zoom	141
Playing Back and Deleting Images	142
<hr/>	
Playing Back Images	142
Switching Between  Mode and  Mode.....	142
Playing Back Still Pictures	142
Nine-Image Display, Folder Display and Calendar Display	143
Zoom Playback.....	145
Zoom Up on the Subject's Face Automatically (Face close-up playback)	146
Displaying Shooting Information in Playback Mode	148
Correcting Camera Shake with Digital SR.....	149
Slideshow	151
Playing Back Movies	153
Playing Back a Movie	153
Connecting the Camera to AV Equipment.....	154
Deleting Images	156
Deleting a Single Image/Sound File	156
Deleting Selected Images and Sound Files (from Nine-Image Display).....	158
Deleting All Images and Sound Files.....	160
Recovering Deleted Images	161
Protecting Images and Sound Files from Deletion (Protect)	162
Editing and Printing Images	164
<hr/>	
Editing Images	164
Changing the Image Size and Quality (Resize).....	164
Cropping Images	166
Copying Images and Sound Files.....	167
Using the Digital Filters.....	169
Red-eye Compensation	172





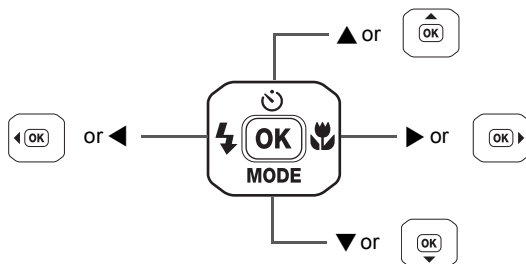

Adding a Frame (Frame Composite).....	173
Editing Movies	175
Setting the Printing Service (DPOF).....	177
Printing Single Images.....	177
Printing All Images.....	179
Printing Using PictBridge	180
Connecting the Camera to the Printer	180
Printing Single Images.....	181
Printing All Images.....	183
Printing Using the DPOF Settings	184
Disconnecting the Cable from the Printer.....	184
Recording and Playing Back Sound	185
<hr/>	
Recording Sound (Voice Recording Mode).....	185
Playing Back Sound	187
Adding a Voice Memo to Images	188
Recording a Voice Memo	188
Playing Back a Voice Memo.....	189
Settings	190
<hr/>	
Camera Settings.....	190
Formatting an SD Memory Card.....	190
Changing the Sound Settings.....	191
Changing the Date and Time.....	193
Setting the Alarm	195
Setting the World Time	197
Changing the Display Language	199
Changing the Image Folder Name	200
Changing the USB Connection Mode.....	201
Changing the Video Output Format.....	202
Adjusting the Brightness of the Display	203
Using the Power Saving Function	204
Setting Auto Power Off.....	205
Setting the Quick Zoom Function	206
Setting the Guide Display	207
Resetting to Default Settings (Reset).....	208
Changing the Start-up Screen	209
Displaying the Clock Mode	210
Appendix	212
<hr/>	
List of World Time Cities	212
Default Settings.....	213
Functions Available for Each Shooting Mode.....	218

Optional Accessories	222
Messages.....	223
Troubleshooting.....	226
Main Specifications	228
WARRANTY POLICY.....	232
Index.....	237

In this manual, the method for operating the four-way controller is shown in illustrations, such as in the one below.



The meanings of the symbols used in this Operating Manual are explained below.

	indicates the reference page number for an explanation of the related operation.
	indicates information that is useful to know.
	indicates precautions to be taken when operating the camera.
 mode	This is the mode for capturing still pictures and recording movies and sound files. In this manual, the mode for taking still pictures is referred to as “Still Picture Capture Mode”, the mode for recording movies is referred to as “  mode”, and the mode for recording sound is referred to as “  mode”.
 mode	This is the mode for viewing still pictures and playing back movies and sound files.

Composition of the Operating Manual

This Operating Manual contains the following chapters.

1 Getting Started

This chapter explains what you need to do after purchasing the camera before you start taking pictures. Be sure to read it and follow the instructions.

2 Quick Start

This chapter explains the simplest way to take pictures and play back images. Use it if you want to start taking pictures or playing back images straightaway.

3 Common Operations

This chapter explains common operations such as the functions of the buttons and how to use the menus. For more details, refer to the respective chapters below.

4 Taking Pictures

This chapter explains the various ways of capturing images and how to set the relevant functions.

5 Playing Back and Deleting Images

This chapter explains how to view still pictures and movies on the camera or on a TV and how to delete images from the camera.

6 Editing and Printing Images

This chapter explains the various ways of printing still pictures and how to edit images with the camera. For information on transferring images to a computer and installing the provided software, see the supplied "PC Connection Manual". For details on editing and printing images on a computer, see the Help menu of the software.

7 Recording and Playing Back Sound

This chapter explains how to record sound files or add sound (a voice memo) to an image and how to play back sound files.

8 Settings

This chapter explains how to set the camera-related functions.

9 Appendix

This section deals with troubleshooting and lists the optional accessories.

1

2

3

4

5

6

7

8

9

Camera Features

In addition to basic picture-taking, the Optio W60 has a variety of shooting modes to suit different situations. This section describes how to make the most of the key features of your camera. Together with the explanations of camera operations, it will enable you to enjoy your camera to the full.

Forget Your Worries About Water Getting in the Camera!

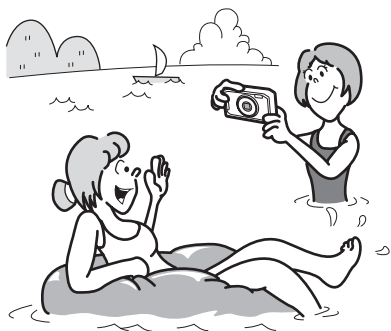

The Optio W60 is waterproof/dustproof, and the water resistant coating on the lens cover glass enables you to take pictures underwater for two hours at a depth of 4 meters (13 ft.). It also allows you to let the camera get hit by sprays of water, and use the camera in locations where it will be exposed to dust and dirt such as the beach, a kitchen, a workshop, etc. Because it utilizes

a lock mechanism for the battery/card/terminal cover, when the cover is firmly locked, you can use it underwater safe in the knowledge that the batteries and card are also secure.

- For taking pictures while snorkeling. (p.69)
- For taking pictures at the pool or while playing in a river or lake.
- For taking pictures while enjoying various outdoor activities without worrying about your camera getting a bit dirty. A quick wipe with a wet cloth is all it needs!

Advanced Movie Recording and Picture Taking Functions

The Optio W60 can record in 16:9 high definition with a frame rate of 15 fps and a resolution of 1280×720. In addition, it comes complete with features to enhance your enjoyment of movies such as image stabilization (Movie SR) during recording and capturing still pictures of important scenes while recording.

- **Preserve the beauty of scenery, such as spectacular natural landscapes, by recording them in high definition.**
[Selecting the Recorded Pixels and Frame Rate for Movies (p.133)]
- **Record the intense action of sporting events without worrying about blurry images. For example, record the player running and capture still shots of the memorable moment when they cross the finish line.**
[Setting the Movie SR (Movie Shake Reduction) Function (p.136)]
[Taking Still Pictures during Movie Recording (p.132)]

Add Assorted Frames to Your Pictures!

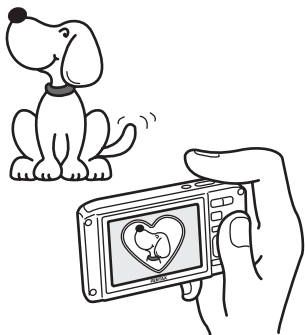

When you take pictures with the Optio W60, you can add a frame to your pictures by selecting one from the wide assortment available. (p.71) You can also add frames to pictures you have taken. Adjust the position of the subject in the picture or reduce or enlarge the picture size to match the frame shape and size. Now you no longer have to worry about the subject not being aligned in the frame. (p.173)

- **For decorating your pictures with a frame.**

Easy-to-Navigate Capture and Playback Functions!



The user-friendly design of the Optio W60 enables easy operation with only a few buttons. Simply by choosing the appropriate icon, you can select the shooting mode (p.56) and choose the optimal settings for the situation or the playback mode (p.142, p.164) and enjoy the various playback and editing functions. A guide on the display lets you check the functions available in each mode and how to use them. (p.56, p.62)

- **A shooting mode guide is displayed in the Capture Mode Palette and a playback mode guide in the Playback Mode Palette for a few seconds after each mode is selected. (p.56, p.62)**
- **Use the Green Mode to take pictures easily using standard settings. (p.66)**

Display Images and Sound Files in Calendar Format!

With the Optio W60, you can display recorded images and sound files by date in calendar format. (p.144) This lets you quickly find the image or sound file you want to play back.

Perfect Size for Carrying Around With You!



With its sporty and sharp design and excellent portability, the Optio W60 is just right to slip into a pocket of your bag or hang round your neck, so you always have it with you, like your cell phone. It has a useful clock function, “Clock Mode” for telling the time too. (p.210)

A multitude of functions inside the camera for enjoying images without a computer!

The Optio W60 has a variety of functions to let you enjoy playing back and editing images without having to connect the camera to your computer and transfer the images first. The camera is all you need to take and edit still pictures and movies. (p.164) And no more worries about accidentally deleting images, because now, with the Optio W60, you can recover them again. (p.161)

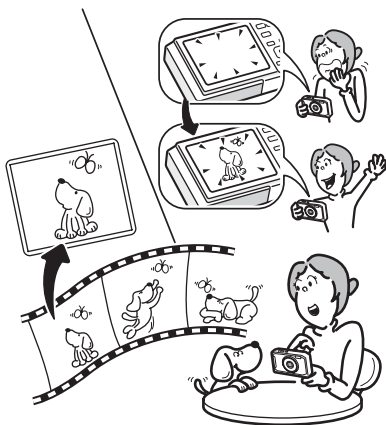

- **Resize (p.164) , Cropping (p.166) , and Red-eye Compensation (p.172) can be used, while the image is displayed in Playback mode.**
- **You can divide a movie into two or select a frame from a movie to save it as a still picture. (p.175)**

Checking the Contents of the Package



Camera
Optio W60

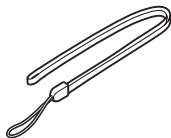

Strap
O-ST20 (*)

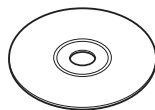

Software (CD-ROM)
S-SW81

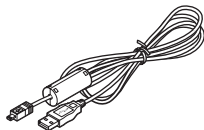

USB cable
I-USB7 (*)

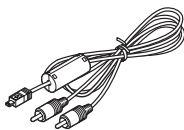

AV cable
I-AVC7 (*)



Rechargeable lithium-ion
battery D-LI78(*)

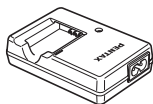

Battery charger
D-BC78 (*)



AC plug cord



PC Connection Manual



Operating Manual
(this manual)



Quick Guide

Items marked with an asterisk (*) are also available as optional accessories. The battery charger and AC plug cord are only sold as a set (Battery Charger Kit K-BC78).

For other optional accessories, refer to "Optional Accessories" (p.222).

Names of Parts

Front

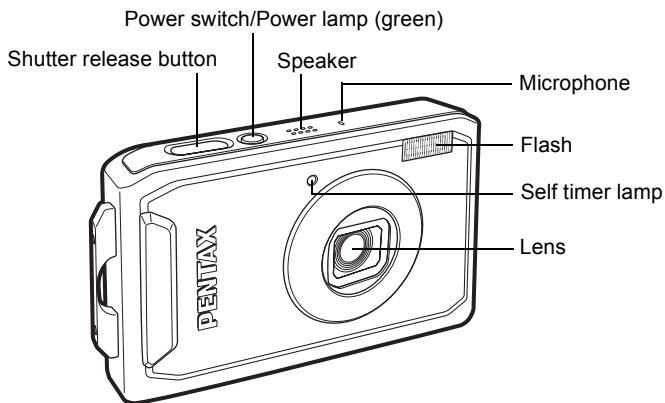

Back

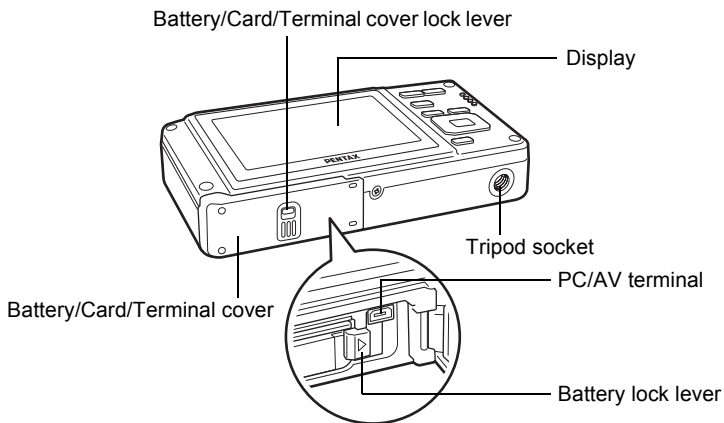

Names of Operating Parts

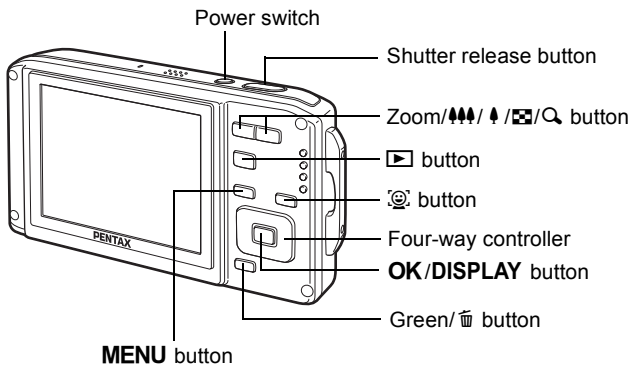





Refer to “Understanding the Button Functions” (p.47 - p.50) for an explanation of the function of each button.

Monitor Indications

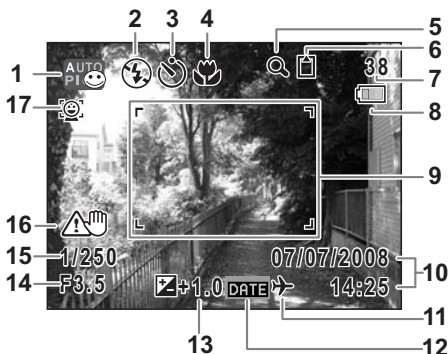
Normal Display in Still Picture Capture Mode

The display shows information such as the shooting conditions. (p.98)



- | | |
|---|---|
| 1 Shooting mode (p.56) | 8 Battery level indicator (p.28) |
| 2 Flash mode (p.102) | 9 Focus frame (p.43) |
| 3 Drive mode (p.87 - p.93) | 10 Date and time (p.41) |
| 4 Focus mode (p.100) | 11 World time setting (p.197) |
| 5 Digital zoom icon (p.94) | 12 Date Imprint setting (p.127) |
| Intelligent zoom icon (p.94) | 13 EV compensation (p.97) |
| 6 Memory status (p.37) | 14 Aperture |
|  : Built-in memory
(without card) | 15 Shutter speed |
|  : SD Memory Card | 16 Camera shake warning (p.98) |
|  : SD Memory Card is write
protected | (shown when blurring caused by
vibration is likely to occur) |
| 7 Storage capacity | 17 Face Priority icon (p.59) |

* 14, 15 and 16 appear only when the shutter release button is pressed halfway.

* Some indications may not appear depending on the shooting mode.

Histogram + Info Display in Still Picture Capture Mode



- | | |
|--|---------------------------|
| 1 Bright portion (blinks red) | 6 Recorded pixels (p.104) |
| 2 Dark portion (blinks yellow) | 7 Quality level (p.107) |
| 3 Camera shake warning (p.98)
(shown when blurring caused by
vibration is likely to occur) | 8 White balance (p.108) |
| 4 Shutter speed | 9 AE Metering (p.110) |
| 5 Aperture | 10 Sensitivity (p.112) |
| | 11 Histogram (p.99) |

* 3, 4 and 5 appear only when the shutter release button is pressed halfway.

* Some indications may not appear depending on the shooting mode.

About the Bright and Dark Portions

When there is an area in the frame that is so bright it appears white, the indicated area blinks red as a warning. Similarly, when there is an area that is so dark it appears black, the indicated area blinks yellow as a warning.

Full Display in Still Picture Playback Mode

(All of the display items are displayed here for explanatory purposes.)

The display shows information such as the shooting conditions. A1 to A11 appear when [Normal Display] or [Histogram + Info] is selected. B1 to B10 only appear when [Histogram + Info] is selected. (p.148)

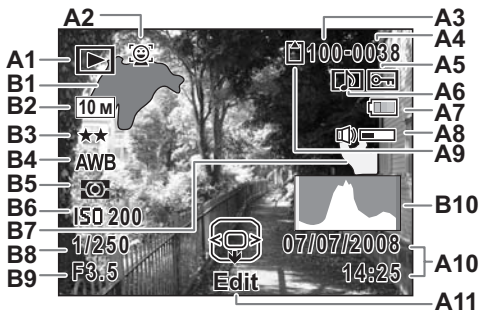

- | | |
|---|---|
| <p>A1 Playback mode
 : Still Picture Playback Mode (p.62)
 : Digital SR (p.149)</p> <p>A2 Face Priority icon (p.59)</p> <p>A3 Folder number (p.200)</p> <p>A4 File number</p> <p>A5 Protect icon (p.162)</p> <p>A6 Voice memo icon (p.189)</p> <p>A7 Battery level indicator (p.28)</p> <p>A8 Volume icon</p> <p>A9 Memory status (p.37)
 : Built-in memory (without card)
 : SD Memory Card
 : Card is write-protected</p> | <p>A10 Captured date and time (p.41)</p> <p>A11 Four-way controller guide</p> <p>B1 Bright portion (blinks red) (p.22)</p> <p>B2 Recorded pixels (p.104)</p> <p>B3 Quality level (p.107)</p> <p>B4 White balance (p.108)</p> <p>B5 AE Metering (p.110)</p> <p>B6 Sensitivity (p.112)</p> <p>B7 Dark portion (blinks yellow) (p.22)</p> <p>B8 Shutter speed</p> <p>B9 Aperture</p> <p>B10 Histogram (p.99)</p> |
|---|---|

- In Normal Display, A7 and A10 disappear if no buttons are operated for two seconds.
- A11 is also displayed when [No Info] is displayed but disappears if no buttons are operated for two seconds. If no buttons are operated for 2 seconds during [Normal Display] or [Histogram + Info], only the [Edit] characters disappear.

Guide Indications

A guide to available button operations appears on the display during operation. The buttons are indicated as shown below.

Four-way controller (▲)	▲
Four-way controller (▼)	▼
Four-way controller (◀)	◀
Four-way controller (▶)	▶
MENU button	

Zoom button	
OK/DISPLAY button	
Shutter release button	
Green/🗑️ button	🗑️
👤 button	

Attaching the Strap

Attach the strap (O-ST20) supplied with the camera.

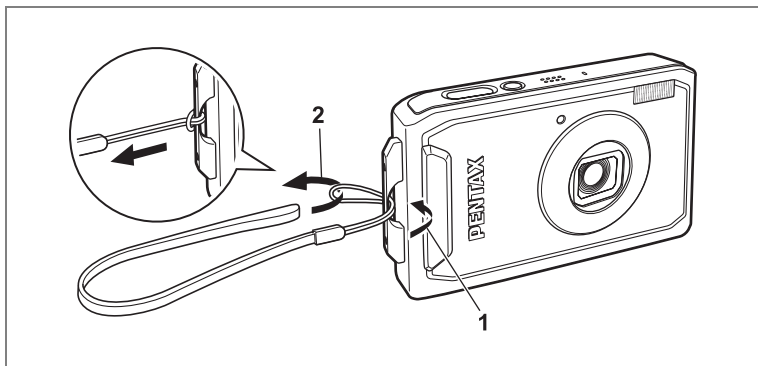

- 1** Pass the narrow end of the strap through the strap lug.
- 2** Pass the other end of the strap through the loop and pull tight.

Powering the Camera

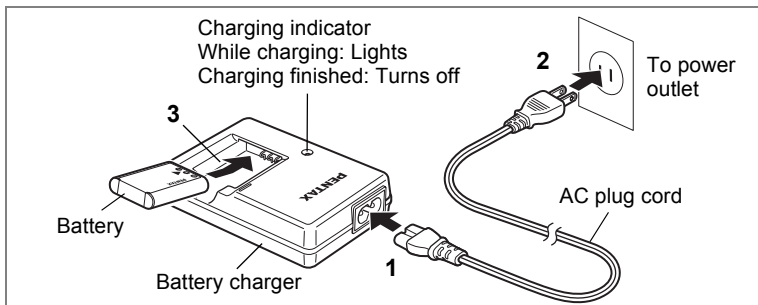

1

Getting Started

Charging the Battery

Use the battery charger to charge the battery before using it in the camera for the first time or after a long period of non-use, or when the [Battery depleted] message appears.

Note: AC plug cord "Listed, Type SPT-2 or NISPT-2, 18/2 flexible cord, rated 125 V, 7A, minimum 6ft (1.8m)"

- 1 Connect the AC plug cord to the battery charger D-BC78.**
- 2 Plug the AC plug cord into the power outlet.**
- 3 Place the battery in the charger so that the PENTAX logo is facing up.**

The charging indicator lights while the battery is charging and turns off when charging is finished.
- 4 Remove the battery from the battery charger when charging is finished.**



- The time required to fully charge the battery is about 150 minutes (max.). The appropriate ambient temperature for charging the battery is 0°C to 40°C (32°F to 104°F). (The charging time may vary depending on the ambient temperature and charging conditions.)
- The battery has reached the end of its service life when it starts to run down soon after being charged. Replace with a new battery.



- Do not use the battery charger to charge batteries other than the rechargeable lithium-ion battery D-LI78, as the charger may overheat or be damaged.
- If the battery is inserted correctly but the charging indicator fails to light, the battery may be faulty. Replace with a new battery.

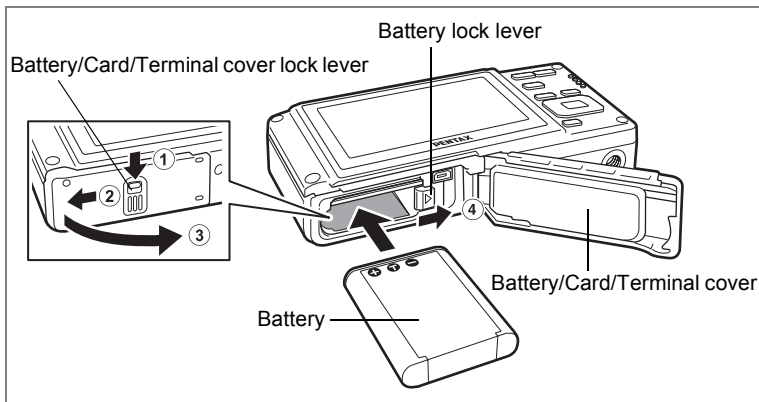

Installing the Battery

Use the battery that is provided with the camera. Charge the battery before using it in the camera for the first time.

1 Open the battery/card/terminal cover.

Press the battery/card/terminal cover lock lever towards ①, slide the cover towards ② and open it towards ③.

2 Using the side of the battery to press the battery lock lever in the direction of ④, insert the battery with the PENTAX logo pointing toward the lens.

Push the battery in until it is locked in place.



Make sure that the battery is inserted with the PENTAX logo pointing toward the lens. If the battery is incorrectly oriented, malfunction may result.

3 Close the battery/card/terminal cover.

Slide the battery/card/terminal cover in the opposite direction indicated by ②. If you hear a click, the cover is securely closed.

Removing the Battery

- 1 Open the battery/card/terminal cover.**
- 2 Press the battery lock lever towards ④.**

The battery pops out slightly. Be careful not to drop it during removal.



- Do not use excessive force when sliding the battery/card/terminal cover open and closed because the waterproof packing may peel off. If the packing is not in the correct position, the waterproof performance of the camera will be compromised.
- If the battery/card/terminal cover is not locked securely when you close it, water, sand, or dirt may get into the camera.
- This camera uses a rechargeable lithium-ion battery D-LI78. Use of any other type of battery may damage the camera and cause malfunction.
- Insert the battery correctly. If the battery is incorrectly oriented, malfunction may result.
- Do not remove the battery while the camera is turned on.
- When storing the battery for more than 6 months, charge the battery for 30 minutes using the battery charger and store the battery separately.

Be sure to recharge the battery every 6 to 12 months. Storing the battery below room temperature is ideal. Avoid storing it in high temperatures.

- The date and time may be returned to the default setting if the camera is left without the battery for a long time.
- Be careful as the camera or the battery may become hot when the camera is used continuously for a long period of time.
- Allow the camera to dry completely before changing the battery. Avoid changing the battery where the camera is likely to get wet or dirty, and make sure that your hands are dry.
- Battery performance may deteriorate as temperature decreases. When using the camera in cold regions, we recommend carrying a spare battery in your pocket to keep it warm. Battery performance will return to normal in normal temperatures.

- **Image Storage Capacity, Movie Recording Time, Sound Recording Time, and Playback Time**
(at 23°C with the display on and the battery fully charged)

Image Storage Capacity ^{*1} (flash used for 50% of shots)	Movie Recording Time ^{*2}	Sound Recording Time ^{*2}	Playback Time ^{*2}
Approx. 205 pictures	Approx. 75 min.	Approx. 240 min.	Approx. 200 min.

*1: Recording capacity shows approximate number of shots recorded during CIPA-compliant testing (with display on, flash used for 50% of the shots, and 23 degrees centigrade). Actual performance may vary according to operating conditions.

*2: According to the result of in-house testing.



- In general, battery performance may temporarily deteriorate as the temperature decreases.
- Be sure to take a spare battery with you when traveling abroad or to a cold region, or if you intend to take a lot of pictures.

• Battery Level Indicator

You can check the battery level by the indicator on the display.

Screen Display	Battery Status
(green)	Adequate power remains.
(green)	Battery is running low.
(yellow)	Battery is running very low.
(red)	Battery is exhausted.
[Battery depleted]	The camera will turn off after this message appears.

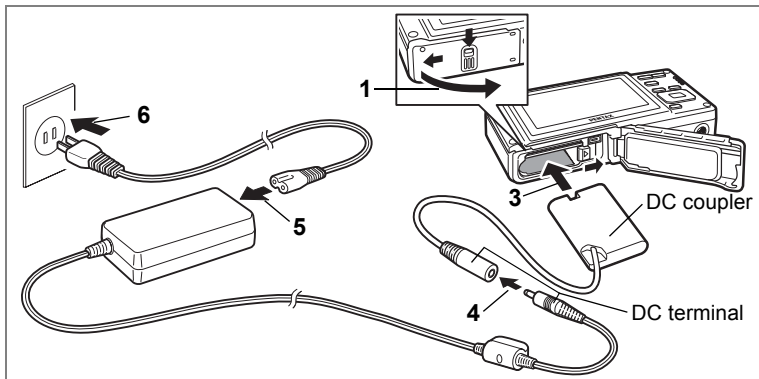

Using the AC Adapter

Use of the AC adapter kit K-AC78 (optional) is recommended if you intend to use the camera for a long time or connect it to a computer.

1 Make sure that the camera is turned off and open the battery/card/terminal cover.

2 Remove the Battery.

Refer to p.26 - p.27 on how to open the battery/card/terminal cover and remove the battery.

3 Insert the DC coupler.

Using the side of the DC coupler to press the battery lock lever, insert the DC coupler. Confirm that the DC coupler is locked in place.

The battery/card/terminal cover will not close while the DC coupler is inserted. Leave the cover open when using the AC adapter and do not attempt to close it.

4 Connect the DC terminal of the AC adapter to the DC terminal of the DC coupler.

5 Connect the AC plug cord to the AC adapter.

6 Plug the AC plug cord into the power outlet.

- Make sure that the camera is turned off before connecting or disconnecting the AC adapter.
- Make sure that the AC plug cord and the power cord connecting the AC adapter to the camera are inserted securely. The data may be lost if either becomes disconnected while data is being recorded on the SD Memory Card or the built-in memory.
- Use the AC adapter with due care to avoid fire or electric shock. Be sure to read “USING YOUR CAMERA SAFELY” (p.1) and “About the Battery Charger and the AC Adapter” (p.2) before using the AC adapter.
- Be sure to read the operation manual accompanying the AC adapter kit K-AC78 before using the adapter.
- When connecting the AC adapter, you cannot set the camera upright on the table because the cord from the DC coupler is extracted from the bottom side of the camera.
- Do not use excessive force when sliding the battery/card/terminal cover open and closed because the waterproof packing may peel off. If the packing is not in the correct position, the camera will not be waterproof.

Installing the SD Memory Card

1

Getting Started

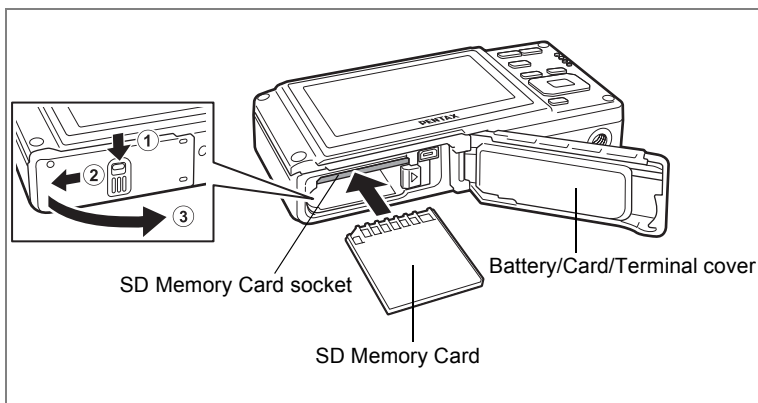

This camera uses an SD Memory Card. Captured images and sound files are saved on the SD Memory Card if a card is inserted in the camera. They are saved in the built-in memory if a card is not inserted. (p.37)



- **Be sure to use this camera to format (initialize) an SD Memory Card that is unused or has been used on other cameras or digital devices. Refer to “Formatting an SD Memory Card” (p.190) for instructions on formatting.**
 - Make sure that the camera is turned off before inserting or removing the SD Memory Card.
 - Allow the camera to dry completely before changing the SD Memory Card. Avoid changing the card where the camera is likely to get wet or dirty, and make sure that your hands are dry.
 - Do not use excessive force when sliding the battery/card/terminal cover open and closed because the waterproof packing may peel off. If the packing is not in the correct position, the camera will not be waterproof.
-
- The still picture storage capacity varies depending on the capacity of the SD Memory Card and the selected number of recorded pixels and quality level. (p.34)
 - The power lamp blinks while the SD Memory Card is being accessed (data is being recorded or read).



Backing Up Data

The camera may not be able to access data in the built-in memory in the case of a malfunction. Use a computer or other device to back up important data in another location.

1 Open the battery/card/terminal cover.

Press the battery/card/terminal cover lock lever towards ①, slide the cover towards ② and open it towards ③.

2 Insert the SD Memory Card into the SD Memory Card socket so that the label is facing toward the front of the camera (the side with the lens).

Push the card in all the way. Images and sound may not be recorded correctly if the card is not inserted all the way.

3 Close the battery/card/terminal cover.

Slide the battery/card/terminal cover lock lever in the opposite direction indicated by ②. If you hear a click, the cover is securely closed.

Removing the SD Memory Card

1 Open the battery/card/terminal cover.



2 Push the card into the SD Memory Card socket to eject it.

Pull the card out.

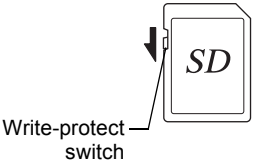

If the battery/card/terminal cover is not locked securely when you close it, water, sand, or dirt may get into the camera.

Precautions When Using an SD Memory Card

- The SD Memory Card is equipped with a write-protect switch. Setting the switch to LOCK protects the existing data by prohibiting recording of new data, deletion of existing data or formatting of the card on either the camera or a computer.   appears on the display when the card is write-protected.
- Care should be taken when removing the SD Memory Card immediately after using the camera, as the card may be hot.
- Do not remove the SD Memory Card or turn off the camera while images or sound files are being recorded or played back, or while connected to a computer with the USB cable. Doing so may result in data corruption or damage to the card.
- Do not bend the SD Memory Card or subject it to violent impact. Keep it away from water and store away from high temperature.
- Do not remove the SD Memory Card during formatting as this may damage the card and render it unusable.
- The data on the SD Memory Card may be deleted in the following circumstances. We do not accept any liability for data that is deleted
 - (1) when the SD Memory Card is mishandled by the user.
 - (2) when the SD Memory Card is exposed to static electricity or electrical interference.
 - (3) when the card has not been used for a long time.
 - (4) when the card is ejected or the battery is removed while the data on the card is being recorded or accessed.
- If it is not used for a long time, the data on the card may become unreadable. Be sure to regularly make a backup of important data on a computer.
- Avoid using or storing the card where it may be exposed to static electricity or electrical interference.
- Avoid using or storing the card in direct sunlight or where it may be exposed to rapid changes in temperature or to condensation.
- When using an SD Memory Card with a slow recording speed, recording may stop while you are taking movies even when there is adequate space in the memory, or shooting and playback may take a long time.
- For information on compatible SD Memory Cards, visit the PENTAX website.
- Be sure to format an SD Memory Card that is unused or has been used on another camera. Refer to "Formatting an SD Memory Card". (p.190)
- Please note that formatting the SD Memory Card will not necessarily delete the data so that it cannot be recovered using off-the-shelf data recovery software. There are off-the-shelf secure data deletion software programs available that will completely delete the data. If you are going to discard, give away or sell your SD Memory Card, you should ensure that the data on the card is completely deleted or the card itself is destroyed if it contains any personal or sensitive information. In any case, the data on your SD Memory Card should be managed at your own risk.

Recorded Pixels and Quality Level of Still Pictures

1

Getting Started

Choose the number of pixels (size) and quality level (data compression rate) of still pictures according to how you intend to use the pictures you have taken.

Higher quality levels and numbers of pixels produce clearer images, but the resulting increase in data volume reduces the total number of pictures that can be taken (stored in the camera's built-in memory or on the SD Memory Card).

The quality of the captured photo or printed picture also depends on the quality level, exposure compensation, resolution of the printer and a variety of other factors, so you do not need to select more than the required number of pixels. As a rough guide, **3M** (2048×1536) is adequate for making postcard-size prints. Refer to the table below for the appropriate settings according to use.

● Appropriate Number of Recorded Pixels According to Use

Recorded Pixels	Use
10M 3648×2736	For printing high quality photos or A4-size pictures, or editing images on a computer. Matching the aspect ratio to HDTV produces undistorted pictures.
7.5M (16:9) 3648×2056	
7M 3072×2304	For making postcard-size prints.
5M 2592×1944	
3M 2048×1536	
1280 1280× 960	For posting on a website or attaching to e-mail.
1024 1024× 768	
640 640× 480	

The default setting is **10M** (3648×2736).

- Selecting **7.5M** changes the horizontal aspect ratio of the image to 16:9.
- Only **1280** (1280×960) can be set for recorded pixels when  (Report) mode (p.58) is set.

● Appropriate Quality Level According to Use

★★★	Best	Lowest compression rate. Suitable for photo prints.
★★	Better	Standard compression rate. Suitable for viewing the image on a computer screen.
★	Good	Highest compression rate. Suitable for posting on a website or attaching to e-mail.

The default setting is **★★ (Better)**.

Choose the appropriate number of recorded pixels and quality level for still pictures on the [📷 Rec.Mode] menu.

Selecting the Recorded Pixels 📷 p.104

Selecting the Quality Level 📷 p.107

● Recorded Pixels, Quality Level and Image Storage Capacity (Approximate numbers of pictures)

	★★★ (Best)		★★ (Better)		★ (Good)	
	Built-in Memory	512 MB	Built-in Memory	512 MB	Built-in Memory	512 MB
10M 3648×2736	9 pictures	117 pictures	17 pictures	228 pictures	24 pictures	321 pictures
7.5M (16:9) 3648×2056	12 pictures	156 pictures	22 pictures	287 pictures	29 pictures	377 pictures
7M 3072×2304	12 pictures	157 pictures	22 pictures	287 pictures	29 pictures	377 pictures
5M 2592×1944	14 pictures	188 pictures	27 pictures	355 pictures	38 pictures	503 pictures
3M 2048×1536	22 pictures	293 pictures	44 pictures	570 pictures	63 pictures	816 pictures
1280 1280× 960	49 pictures	643 pictures	86 pictures	1119 pictures	116 pictures	1511 pictures
1024 1024× 768	75 pictures	974 pictures	122 pictures	1590 pictures	155 pictures	2014 pictures
640 640× 480	155 pictures	2014 pictures	233 pictures	3022 pictures	259 pictures	3358 pictures

- The above figures may vary depending on the subject, shooting conditions, shooting mode and SD Memory Card, etc.
- Only **1280** (1280×960) can be set for recorded pixels when 📷 (Report) mode (p.58) is set.

Recorded Pixels for Movies/Frame Rate

You can set the recorded pixels and frame rate (number of frames per second) to suit the intended use of your movie.





The higher the number of recorded pixels, the clearer the picture and the bigger the file size.

The more frames per second, the better the quality of the movie, but the bigger the file size.

The recorded pixels and frame rate for movies are set in [Recorded Pixels] under [Movie] on the [📷 Rec.Mode] menu.





Selecting the Recorded Pixels and Frame Rate for Movies 📷 p.133

● Combinations of Recorded Pixels and Frame Rate, and Suggested Uses

 (1280×720) : 15fps	↑ ↓	HD movies with a horizontal aspect ratio of 16:9 (*).
 (640×480) : 30fps		For watching on a TV and other AV equipment.
 (640×480) : 15fps		
 (320×240) : 30fps		
 (320×240) : 15fps		For posting on websites or attaching to e-mails.

* Playback requires a computer.

● Combinations of Recorded Pixels and Frame Rate, and Estimated Recording Times

	Rec. time		Available Sound Recording Time	
	Built-in Memory	512 MB	Built-in Memory	512 MB
 (1280×720) : 15fps	34 sec.	7 min. 31 sec.	28 min. 53 sec.	6 hr. 14 min. 15 sec.
 (640×480) : 30fps	34 sec.	7 min. 31 sec.		
 (640×480) : 15fps	1 min. 8 sec.	14 min. 48 sec.		
 (320×240) : 30fps	55 sec.	11 min. 59 sec.		
 (320×240) : 15fps	1 min. 46 sec.	22 min. 53 sec.		

- The above figures are based on our standard shooting conditions and may vary depending on the subject, shooting conditions and type of SD Memory Card used.
- Movies can be continuously recorded until the built-in memory or SD Memory Card is full, or when using a high capacity SDHC card until the size of the movie reaches 2 GB. If recording stops at 2 GB, start recording again to continue to record the rest of the movie in blocks of 2 GB.
- The quality level is fixed at ★★★ (Best).

Turning the Camera On and Off

1

Getting Started

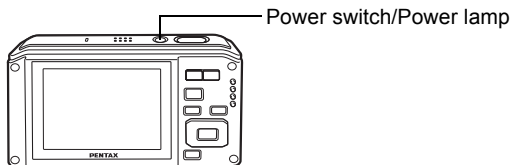

1 Press the power switch.

The camera turns on and both the power lamp and display turn on. If the Language Selection screen or Date Adjust screen appears when you turn the camera on, follow the procedure on p.39 to set the display language and/or current date and time.

2 Press the power switch again.

The camera turns off and both the power lamp and display turn off.

Taking Pictures p.64

Checking the Memory Card

The memory card is checked automatically when the camera turns on. appears on the display when there is no SD Memory Card inserted in the camera. In this case, images and sound files will be saved in the built-in memory.

appears instead of when the write-protect switch on the SD Memory Card is in the locked position. Images and sound cannot be recorded when the write-protect switch is locked.

Memory status



37

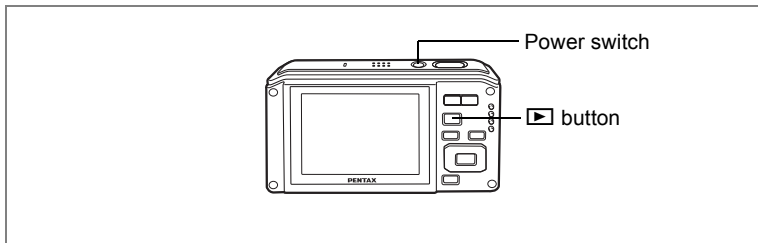

Playback Mode

Use this mode when you want to play back an image or sound file straightaway without taking any more pictures.

1 Press the power switch while holding down the ▶ button.

The display turns on and the camera starts up in playback mode.



To switch from Playback Mode to  mode, press the ▶ button or press the shutter release button halfway.

Playing Back Still Pictures  p.45

Initial Settings

Set the language, time, and date after purchasing the camera before you start taking pictures.

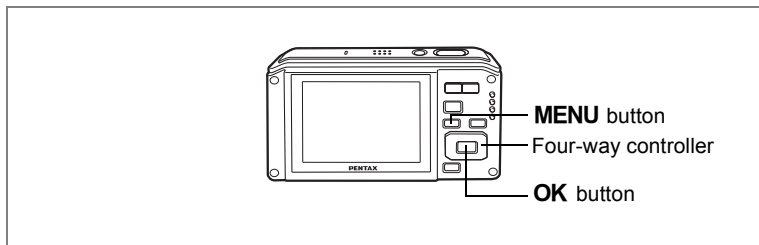

The [Language/言語] screen appears when the camera is turned on for the first time. Perform the operations in “Setting the Display Language” below to set the language, and in “Setting the Date and Time” (p.41) to set the current date and time.

Language, Date, and Time can be changed later. Refer to the pages below for instructions.

- To change the language, follow the steps in “Changing the Display Language” (p.199).
- To change the date and time, follow the steps in “Changing the Date and Time” (p.193).

Setting the Display Language

- 1 Use the four-way controller (▲▼◀▶) to choose the display language.



2 Press the OK button.

The Initial Setting screen appears in the selected language. If the desired settings for [Hometown] and daylight saving time appear, press the **OK** button again to display the [Date Adjust] screen. Go to “Setting the Date and Time” (p.41). Go to Step 3 in “Setting Hometown and DST” (p.41) if the desired settings do not appear.

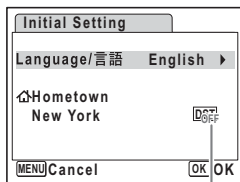

Daylight saving time

If you accidentally select another language and go to the next procedure, perform the following operation to set the language back.

● When Another Language Has Been Inadvertently Selected

- 1 Press the four-way controller (▶).
- 2 Use the four-way controller (▲ ▼ ◀ ▶) to select the language and press the **OK** button.

The Initial Setting screen appears in the selected language.

● When the Screen After Step 2 Appears in Another Language

- 1 Press the **OK** button.
- 2 Press the **MENU** button.
- 3 Press the four-way controller (▶).
- 4 Use the four-way controller (▼ ▲) to select [Language/言語].
- 5 Press the four-way controller (▶).
The [Language/言語] screen appears.
- 6 Use the four-way controller (▲ ▼ ◀ ▶) to select the language.
- 7 Press the **OK** button.

The [↶ Setting] menu appears in the selected language.

The language is now switched to your desired language. To reset Hometown and the Date and Time, refer to the pages below for instructions.

- To change Hometown, follow the steps in “Setting the World Time” (p.197).
- To change the Date and Time, follow the steps in “Changing the Date and Time” (p.193).

Setting Hometown and DST

- 3 Press the four-way controller (▼).**
The frame moves to [Hometown].
- 4 Press the four-way controller (▶).**
The Hometown screen appears.
- 5 Use the four-way controller (◀▶) to choose the city.**
- 6 Press the four-way controller (▼).**
The frame moves to [DST] (Daylight Saving Time).
- 7 Use the four-way controller (◀▶) to select (On) or (Off).**
- 8 Press the OK button.**
The Initial Setting screen appears.
- 9 Press the OK button.**
The Date Adjust screen appears. Next, set the date and time.

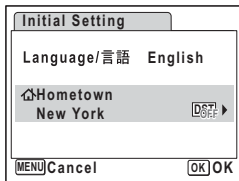

Setting the Date and Time

Set the current date and time and the display style.

- 1 Press the four-way controller (▶).**
The frame moves to [mm/dd/yy].
- 2 Use the four-way controller (▲▼) to choose the date and time display style.**
- 3 Press the four-way controller (▶).**
The frame moves to [24h].
- 4 Use the four-way controller (▲▼) to select [24h] (24-hour display) or [12h] (12-hour display).**
- 5 Press the four-way controller (▶).**
The frame returns to [Date Style].

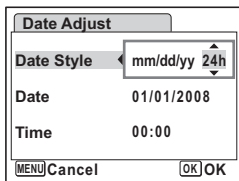
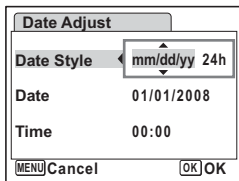

6 Press the four-way controller (▼).

The frame moves to [Date].

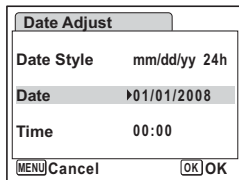

7 Press the four-way controller (▶).

The frame moves to the month.

8 Use the four-way controller (▲▼) to change the month.

Change the day and year in the same manner. Next, change the time.

If you selected [12h] in Step 4, the setting switches between am and pm corresponding to the time.

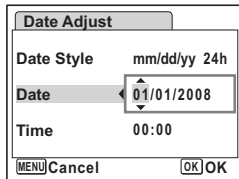

9 Press the OK button.

The setting is set and the camera returns to capture status.

Language, Date, Time, Hometown, and DST can be changed. Refer to the pages below for instructions.

- To change the language, follow the steps in “Changing the Display Language” (p.199).
- To change the date and time, follow the steps in “Changing the Date and Time” (p.193).
- To change the city or turn DST on and off, follow the steps in “Setting the World Time” (p.197).



When the Initial Setting or Date Adjust screen is displayed, you can cancel the setting operation and switch to Capture mode by pressing the **MENU** button. In this case, the Initial Setting screen will appear next time you turn the camera on.



If you press the **OK** button in Step 9, the camera clock is reset to 00 seconds. To set the exact time, press the **OK** button when the time signal (on the TV, radio, etc.) reaches 00 seconds.

The video output format (NTSC/PAL) is set to the format of the city selected in [Hometown] on the Initial Setting screen. Refer to “List of World Time Cities” (p.212) for the video output format of each city set as the Initial Setting, and “Changing the Video Output Format” (p.202) for changing the setting of the video output format.

Taking Still Pictures

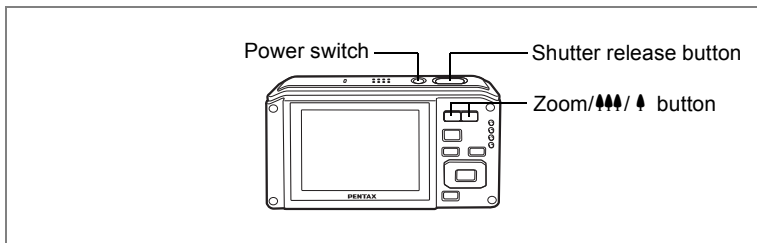

The standard procedure for taking still pictures is described below. The flash fires automatically depending on the light conditions.

1 Press the power switch.

The camera turns on and is ready to take still pictures. In this manual, this is called Still Picture Capture mode.

2 Confirm the subject and shooting information on the display.

The focus frame in the middle of the display indicates the zone of automatic focusing.

You can change the captured area by pressing the Zoom/▲▲▲/▲ button to the left or right.

▲ : enlarges the subject

▲▲▲ : widens the area that is captured by the camera

3 Press the shutter release button halfway.

The focus frame on the display turns green if the subject is in focus.

4 Press the shutter release button fully.

The picture is taken.

The image appears on the display for one second (Instant Review) and is saved to the SD Memory Card or built-in memory. (p.44)



Focus frame



Press the Green button to switch to the ● (Green) mode and let the camera set all the shooting functions automatically. (p.66)

Using the Shutter Release Button

The shutter release button works in a two-step action as follows.

Press halfway

The focus and exposure are locked when the shutter release button is pressed down half-way. The green focus frame lights on the display when the shutter release button is pressed halfway and the subject is in focus. If the subject is out of focus, the frame turns red.

Press fully

Press the shutter release button all the way down to take a picture.

[Poor focusing conditions]

The camera may not be able to focus under the following conditions. In these cases, lock the focus on an object the same distance away as the subject (by pressing and holding the shutter release button halfway), then aim the camera at your subject and press the shutter release button fully.

- Objects that lack contrast such as a blue sky or white wall
- Dark places, objects, or conditions that prevent light being reflected back
- Horizontal lines or intricate patterns
- Fast moving objects
- When there is an object in the foreground and an object in the background in the same picture
- Strongly reflected light or strong backlighting (bright background)

Instant Review

The image appears on the display for one second (Instant Review) immediately after it is captured. You can change the Instant Review time. (p.120)

Pressing the  button during Instant Review displays the delete image confirmation screen. Select [Delete] with the four-way controller (▲▼) and press the **OK** button to delete the image.



- When the camera detects that the subject's eyes are closed, the message "Closed eyes have been detected." appears during Instant Review (This function is called "Blink Detection").
- Even when Instant Review is set shorter than [3sec], the message appears for 3 seconds.
- When the Face Recognition function (p.59) does not work, "Blink Detection" also does not function. Even if the subject's faces are recognized, "Blink Detection" does not function depending on the condition of the recognized faces.

Playing Back Still Pictures

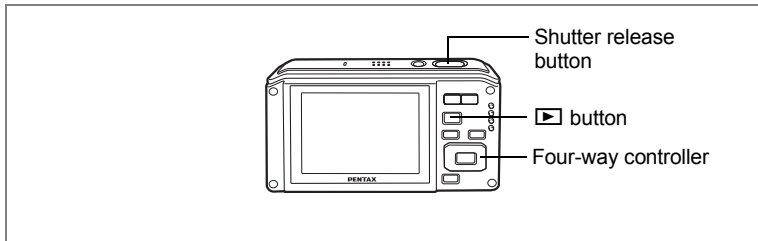

Playing Back Images

- 1 **Press the ▶ button after taking a picture.**

The image appears on the display. In this manual, this is called ▶ mode (Playback mode). Displaying one image in full in ▶ mode (▶ mode default setting) is called single-image display.

Press the ▶ button again in ▶ mode or press the shutter release button halfway to switch to mode.



Playing Back the Previous or Next Image

- 1 **Press the ▶ button after taking a picture.**

The image appears on the display.

- 2 **Press the four-way controller (◀▶).**

The previous or next image appears.

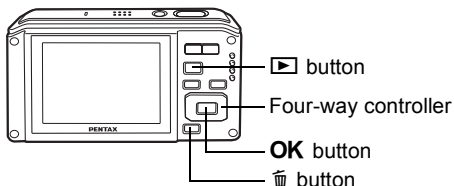

Rotating the Displayed Image

1 Press the ▶ button after taking a picture.

The image appears on the display.

2 Press the four-way controller (▼).

The Playback Mode Palette appears. (p.62)

3 Use the four-way controller (▲▼◀▶) to select ◊ (Image Rotation) and press the OK button.

The rotation selection screen (0°, Right 90°, Left 90°, or 180°) appears.

4 Use the four-way controller (▲▼◀▶) to choose the rotation direction and press the OK button.

The rotated image appears. The image is saved in the orientation displayed.

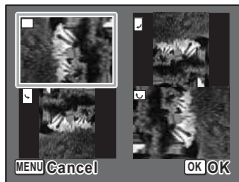

- Movies cannot be rotated.
- Protected images can be rotated, but they cannot be saved in a rotated state.

Deleting the Displayed Image

Press the 🗑 button while the image is displayed to display the Delete screen. Use the four-way controller (▲) to select [Delete] and press the OK button. (p.156)



Understanding the Button Functions

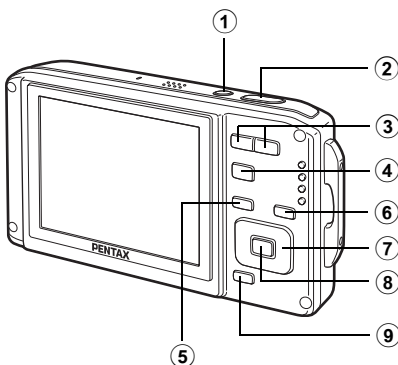

Mode

- ① **Power switch**
Turns the camera on and off. (p.37)
- ② **Shutter release button**
Focuses the camera on the subject when pressed halfway in Still Picture Capture mode. (Except in **PF**, **▲** and **MF** modes) (p.43)
Takes the still picture when pressed down fully. (p.43)
Pressing down fully starts and stops movie recording in **MOVIE** (Movie) and **UNDERWATER MOVIE** (Underwater Movie) modes. (p.69, p.130)
Pressing down fully starts and stops sound file recording in **VOICE RECORDING** (Voice Recording) mode. (p.185)
- ③ **Zoom/AAA/▲ button**
Changes the captured area. (p.94)
- ④ **▶ button**
Switches to the **▶** mode. (p.142)
- ⑤ **MENU button**
Displays the [Rec.Mode] menu. (p.51)

⑥

☺ button

Switches the Face Recognition function (p.59). The Face Recognition function is switched as follows each time the ☺ button is pressed:

Smile Capture → Face Priority Off → Face Priority On

⑦

Four-way controller

(▲) : Changes the drive mode. (p.87 - p.93)

(▼) : Displays the Capture Mode Palette. (p.56)

(◀) : Changes the flash mode. (p.102)

(▶) : Changes the focus mode. (p.100)

(▲▼) : Adjusts **MF** in **MF** mode. (p.101)

⑧

OK/DISPLAY button

Changes the information on the display. (p.98)

⑨

Green button

Switches to the ● (Green) mode. (p.66)

Takes a still picture during movie recording. (p.132)

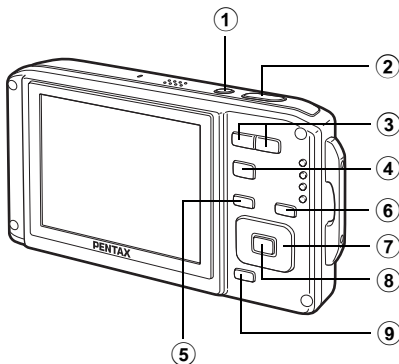

▶ Mode

- ① **Power switch**
Turns the camera on and off. (p.37)
- ② **Shutter release button**
Switches to mode. (p.142)
- ③ **Zoom//**
In single-image display, pressing towards switches to nine-image display. Press to return to the previous display. (p.143)
In single-image display, pressing towards enlarges the image. Press to return to the previous display. (p.145)
In nine-image display, pressing towards displays either folder or calendar display. (p.144)
In folder display, pressing towards switches to nine-image display of the selected folder. (p.144)
In calendar display, pressing towards switches to nine-image display for the selected date. (p.144)
Adjusts the volume during playback of movies or sound files. (p.153, p.187)
- ④ **button**
Switches to mode. (p.142)

⑤ MENU button

- Displays the [ Setting] menu during single-image display. (p.51)
- Returns to single-image display during Playback Mode Palette display. (p.62)
- Returns zoom display or nine-image display to single-image display. (p.143)
- Changes to normal nine-image display during folder display. (p.144)
- Changes to normal nine-image display during calendar display. (p.144)

⑥ button

- Zooms up on the subjects' faces in the order in which they were recognized during shooting. (Face close-up playback) (p.146)

⑦ Four-way controller

- (▲) : Plays back and pauses a movie or sound file. (p.153, p.187)
- (▼) : Displays the Playback Mode Palette. (p.63)
Stops a movie or sound file during playback. (p.153, p.187)
- (◀▶) : Displays the previous or next image and sound file during single-image display. (p.45)
Frame forwards, frame reverses, reverses a movie and makes a movie play forwards during playback. (p.153)
Fast forwards, reverses, and moves to the next index in sound file playback. (p.187)
- (▲▼◀▶) : Moves the display area during zoom display. (p.145)
Selects an image in nine-image display, a folder in folder display, and a date in calendar display. (p.143, p.144)
Moves the image when using the Frame Composite function. (p.173)

⑧ OK/DISPLAY button

- Changes the information on the display. (p.148)
- Returns zoom display or nine-image display to single-image display. (p.143, p.145)
- Changes to nine-image display of the selected folder during folder display. (p.144)
- Changes to single-image display of the selected date during calendar display. (p.144)

⑨ Green/ button

- Switches from single-image display to the Delete screen. (p.156)
- Switches from nine-image display to the Select & Delete screen. (p.158)
- Switches from folder display to the calendar display screen. (p.144)
- Switches from calendar display to the folder display screen. (p.144)

Setting the Camera Functions

To change the camera settings, press the **MENU** button to display the [📷 Rec.Mode] menu or [⏮ Setting] menu. Menus for playing back and editing images and sound files are displayed from the Playback Mode Palette.

Setting with the Menus

Press the **MENU** button in 📷 mode to display the [📷 Rec.Mode] menu. Press the **MENU** button in ▶ mode to display the [⏮ Setting] menu.

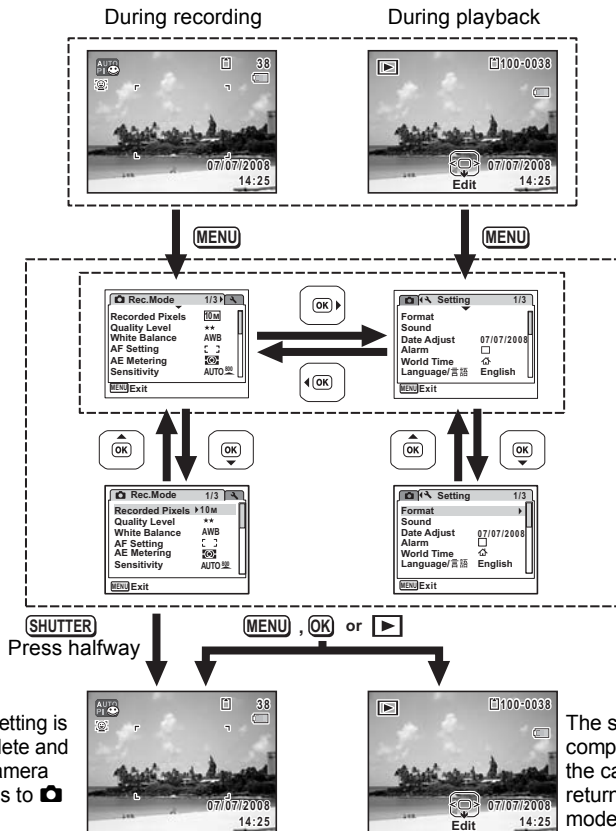



A guide to available button operations appears on the display during menu operation.

Ex.) To set the [Quality Level] on the [📷 Rec.Mode] menu

1 Press the MENU button in 📷 mode.

The [📷 Rec.Mode] menu appears.

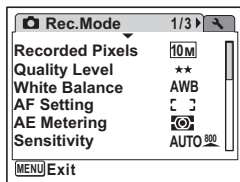

2 Press the four-way controller (▼).

The frame moves to [Recorded Pixels].

3 Press the four-way controller (▼).

The frame moves to [Quality Level].

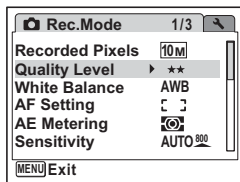

4 Press the four-way controller (▶).

A pull-down menu appears with the items that can be selected.

The pull-down menu displays only those items that can be selected with the current camera settings.

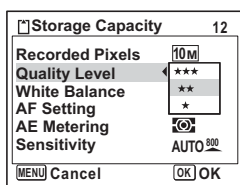

5 Use the four-way controller (▲▼) to change the setting.

The quality level changes each time the four-way controller (▲▼) is pressed.

Refer to the following page for instructions on saving settings and canceling changes.

To Save the Setting and Start Taking Pictures

6 Press the shutter release button halfway.

The setting is saved and the camera returns to capture status.
When the shutter release button is pressed fully, the picture is taken.



When the [Setting] menu is displayed from mode, you can switch to mode by pressing the button.

To Save the Setting and Begin Playback of Images

6 Press the button.

When the [Rec.Mode] menu is displayed from mode, the setting is saved and the camera returns to playback status.

To Save the Setting and Continue with Menu Operations

6 Press the OK button or the four-way controller ().

The setting is saved and the screen returns to Step 3.

To Cancel the Changes and Continue with Menu Operations

6 Press the MENU button.

The changes are canceled and the screen returns to Step 3.



The **MENU** button function differs depending on the screen. Refer to the guide indications.

Exit :Exits the menu and returns to the original screen.

:Returns to the previous screen with the current setting.

Cancel :Cancels the current selection, exits the menu and returns to the previous screen.

Menu List

This displays the items that can be set with the menus and provides descriptions of each item. See the list of default settings in the Appendix “Default Settings” (p.213) to decide whether you want the settings saved when the camera is turned off and whether you want the settings returned to the defaults when the camera is reset.

[📷 Rec.Mode] Menu

This menu shows the functions related to taking still pictures and recording movies.

Item	Description	Page	
Recorded Pixels	You can set the recorded pixels of still pictures	p.104	
Quality Level	You can set the quality level of still pictures	p.107	
White Balance	For adjusting the color balance according to the lighting conditions	p.108	
AF Setting	For setting the specified range of the autofocus	p.115	
AE Metering	For setting the area of the screen that is metered to determine the exposure	p.110	
Sensitivity	For setting the sensitivity	p.112	
EV Compensation	For adjusting the overall brightness of the picture	p.97	
Movie	Recorded Pixels	For choosing the combination of recorded pixels and the frame rate (number of frames per second) for the movie	p.133
	Color Mode	You can set the color mode of movies	p.135
	Movie SR	For choosing whether to use the shake reduction function	p.136
	Interval Shoot	For recording multiple still pictures taken at a set interval as a movie file	p.137
	AF w/ recording	For setting the focusing method used while recording movies	p.140
	Optical Zoom	For setting whether to use the optical zoom while recording movies	p.141
Interval Shoot	Interval	For setting the interval between shots	p.90
	Number of Shot	For setting the number of shots to be taken	p.90
	Start delay	For setting the start time for interval shooting	p.90
Blink Detection	For setting whether to enable Blink Detection	p.61	
Digital Zoom	For setting whether to use the digital zoom	p.96	
Instant Review	For setting the Instant Review time	p.120	
Memory	For choosing whether to save the set values of the shooting function or return to the defaults when the camera is turned off	p.128	
Green Button	For assigning a function to the Green button in Capture mode	p.121	
Sharpness	For setting either sharp or soft outlines for images	p.124	

Item	Description	Page
Saturation	For setting the color saturation	p.125
Contrast	For setting the image contrast level	p.126
Date Imprint	For setting whether to imprint the date when taking still pictures	p.127



Use the  (Green) mode to enjoy easy picture-taking using standard settings, regardless of the settings in the [📷 Rec.Mode] menu. (p.66)

[🔧 Setting] Menu

Item	Description	Page
Format	For formatting the SD Memory Card	p.190
Sound	For adjusting the operation volume and playback volume, and setting the start-up sound, shutter sound, key operation sound and self-timer sound	p.191
Date Adjust	For adjusting the date, time, and date style	p.193
Alarm	For setting the alarm	p.195
World Time	For setting the world time	p.197
Language/言語	For setting the language in which menus and messages appear	p.199
Folder Name	For choosing how names are assigned to folders for storing images and sound files	p.200
USB Connection	For setting the USB cable connection (to computer or printer)	p.201
Video Out	For setting the output format to the AV equipment	p.202
Brightness Level	For changing the brightness of the display	p.203
Power Saving	For setting the time until the camera enters power-saving mode	p.204
Auto Power Off	For setting the time until the camera turns off automatically	p.205
Quick Zoom	For setting whether to use the Quick Zoom function (p.145) when playing back images	p.206
Guide Display	For setting whether to display a guide for selectable functions in the Capture Mode Palette and the Playback Mode Palette displays	p.207
Reset	For returning settings other than the date and time, language, world time and video out to their defaults	p.208

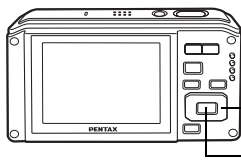

Four-way controller

OK button

Setting the Shooting Mode

The Optio W60 has a variety of shooting modes that let you take pictures or record movies and sound in different situations simply by choosing the right mode for the particular situation from the Capture Mode Palette.

1 Press the four-way controller (▼) in mode.

The Capture Mode Palette appears.

2 Use the four-way controller (▲▼◀▶) to choose a shooting mode.

A guide of the selected shooting mode is displayed in the lower part of the display.



3 Press the OK button.

The shooting mode is selected and the camera returns to capture status.











- In shooting modes other than , , , , , and , saturation, contrast, sharpness, white balance, etc. are automatically set to the optimal settings for the selected mode.
- Some functions may not be available or may not function fully depending on the selected shooting mode. For details, refer to “Functions Available for Each Shooting Mode” (p.218 - p.221).
- You can turn off the shooting mode guide on the Capture Mode Palette. (p.207)

There are 24 available shooting modes.

Item	Description	Page
Auto Picture	Automatically selects the best capture mode.	p.64
Program	Used for basic shooting. Various functions can also be set with this mode.	p.65
Night Scene	Used for night scenes. Use a tripod, etc. to prevent image shake.	p.68
Movie	For capturing movies. Sound is also recorded.	p.130
Underwater	For capturing images under water.	p.69
Underwater Movie	Use this mode for taking underwater movie.	p.69
Landscape	For capturing landscape views. The camera focuses on a wide range.	—
Flower	For capturing flowers. Reproduces the outline of the flower softly.	—
Portrait	For capturing portraits. Makes the skin tone brighter and look healthy.	p.73
Digital Wide	Composites two images to capture a wider area.	p.84
Surf & Snow	For capturing images with dazzling backgrounds, snowy scenes or beaches.	—
Digital SR (Blur Reduction)	Higher sensitivity reduces blur.	p.68
Kids	For capturing moving kids. Reproduces healthy and bright skin tone.	p.79
Pet	For capturing pets in motion. Select the color of the pet's coat.	p.77
Half-length Portrait	For portraits with proper framing by automatic zoom. Fixed at pixels.	p.75
Sport	For fast moving subjects. Keeps the camera in focus until the shutter release.	—
Fireworks	For capturing fireworks. Use a tripod, etc. to prevent image shake.	p.68

Item		Description	Page
	Voice Recording	For recording sound only. Be careful not to cover the microphone with your hands.	p.185
	Night Scene Portrait	For portraits in night scenes. Use a tripod, etc. to prevent image shake.	p.73
	Text	For taking clear pictures of text in color or B/W, normal or reversed.	p.81
	Food	For capturing food. Saturation is higher to make it look appetizing.	—
	Digital Panorama	Stitches images taken with the camera to create a panoramic photograph.	p.82
	Frame Composite	For capturing image with frame composite. Recorded pixels is fixed at 3M .	p.71
	Report	For capturing an image with fixed 1280×960 pixels for reports.	—

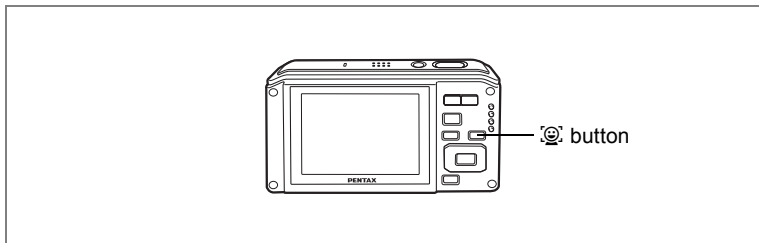

Setting the Face Recognition function

With the Optio W60, the Face Recognition function is available with all shooting modes except  mode.

In the Face Recognition function, you can choose the Face Priority function that recognizes the subject's face, focuses (Face Recognition AF) and performs exposure compensation (Face Recognition AE), and the Smile Capture function* that recognizes the subject's face, focuses (Face Recognition AF), performs exposure compensation (Face Recognition AE) and captures an image automatically.

* Depending on the condition of the recognized faces, an image may not be captured automatically because the Smile Capture function will not work. If this happens, press the shutter release button to capture an image.

Switching the Face Recognition Function

By default, the Face Recognition function is set to Face Priority On. The Face Recognition function is switched as follows each time the  button is pressed: Smile Capture → Face Priority Off → Face Priority On

Face Priority On



Smile Capture



Face Priority Off



The following icons are displayed on the upper left of the shooting screen while Face Priority On and Smile Capture are set to on.













Face Priority On



Smile Capture

An icon indicating either Face Priority On or Smile Capture appears on the display. (The icon does not appear when the Face Recognition function is not activated.)



- The Face Recognition function cannot be set to off in  (Auto Picture),  (Portrait),  (Night Scene Portrait),  (Kids) or  (Half-length Portrait) mode. You can select either the Face Priority On or Smile Capture function.
- Face Priority On is automatically selected in  (Auto Picture),  (Portrait),  (Night Scene Portrait),  (Kids),  (Half-length Portrait) or  (Movie) mode. When switching to another mode from one of these modes, the Face Recognition setting returns to the previous setting.
- Refer to p.73 and p.79 on how to shoot with the Face Recognition function.

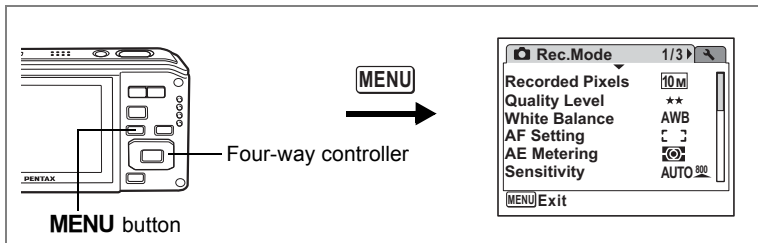

Setting Blink Detection

For setting whether to use Blink Detection.

If the subject's eyes are closed and a picture is taken while both Blink Detection and Face Priority are on, the "Closed eyes have been detected." message appears in Instant Review.

1 Press the **MENU** button in mode.

The [Rec.Mode] appears.

2 Use the four-way controller () to select [**Blink Detection**].

3 Use the four-way controller () to select (**On**) or (**Off**).

The selected setting is saved.

4 Press the **MENU** button.

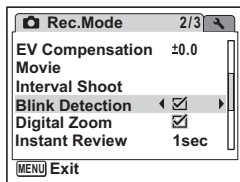

Caution

- When Face Priority is off, Blink Detection is also turned off, regardless of the setting.
- When the Face Recognition function (p.59) does not work, "Blink Detection" also does not function. Even if the subject's faces are recognized, "Blink Detection" might not function depending on the condition of the recognized faces.
- Even when Instant Review is set shorter than [3sec], the message "Closed eyes have been detected." appears for 3 seconds.

Using the Playback Function

Press the four-way controller (▼) in  mode to display the Playback Mode Palette.

You can display the playback function you want to use simply by using the four-way controller (▲▼◀▶) to choose an icon and pressing the **OK** button.

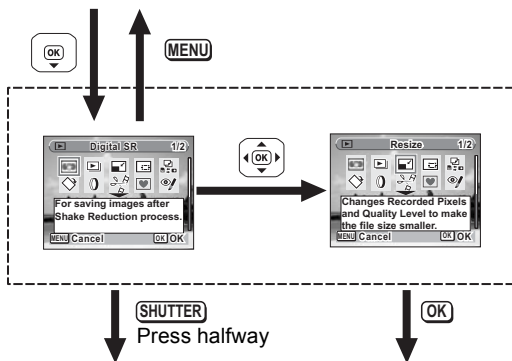

Closes the Playback Mode Palette and goes to  mode.

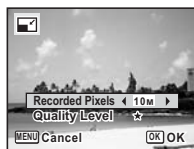















Goes to the screen for selected playback function.



- When the frame is placed over each icon of the Playback Mode Palette, a guide for each function appears.
- You can turn off the guide for each function on the Playback Mode Palette. (p.207)

Playback Mode Palette

Item		Description	Page
	Digital SR	For saving images after Shake Reduction process.	p.149
	Slideshow	For continuously playing back images. Screen or sound effects can be set.	p.151
	Resize	Changes Recorded Pixels and Quality Level to make the file size smaller.	p.164
	Cropping	For cropping images to the size you like. Saved as a new image.	p.166
	Image/Sound Copy	For copying images and sounds between the built-in memory and SD Memory Card.	p.167
	Image Rotation	Rotates captured images. Useful when viewing vertical images on a TV.	p.46
	Digital Filter	For modifying images with a Color filter or Soft filter.	p.169
	Movie Edit	For cutting out a still image from a movie or dividing a movie.	p.175
	Frame Composite	For composing an image with a frame. Select Overwrite or Save as to save.	p.173
	Red-eye Compensation	For compensating red-eye. May not work due to the condition of the image.	p.172
	Voice Memo	Attaches sound to images. Recording is possible till the memory card is full.	p.188
	Protect	Protects images and sounds from accidental deletion. Formatting will delete.	p.162
	DPOF	For the print settings. Useful when printing at a printing service.	p.177
	Image Recovery	For recovering image and sound files which were accidentally deleted.	p.161
	Start-up Screen	For setting a captured image as the Start-up Screen.	p.209

Taking Pictures

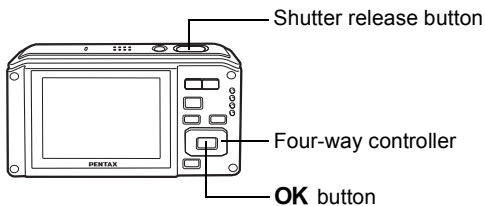

4

Taking Pictures Automatically (Auto Picture Mode)

In **AUTO PICT** (Auto Picture) mode, when the subject simply turns towards the camera, the camera selects the most appropriate shooting mode from **☾** (Night Scene), **🌄** (Landscape), **👤** (Portrait), **🌃** (Night Scene Portrait), **🏃** (Sport), **🌸** (Flower), **📷** (Standard) for the scene.

- 1 Press the four-way controller (▼) in **📷** mode.**
The Capture Mode Palette appears.
- 2 Use the four-way controller (▲▼◀▶) to select **AUTO PICT** (Auto Picture).**
- 3 Press the OK button.**
- 4 Press the shutter release button halfway.**
The focus frame on the display turns green when the subject is in focus, and the icon for selected shooting mode will appear on the top left of the display.
- 5 Press the shutter release button fully.**
The picture is taken.



In **AUTO PICT** mode, the exposure compensation is not available.

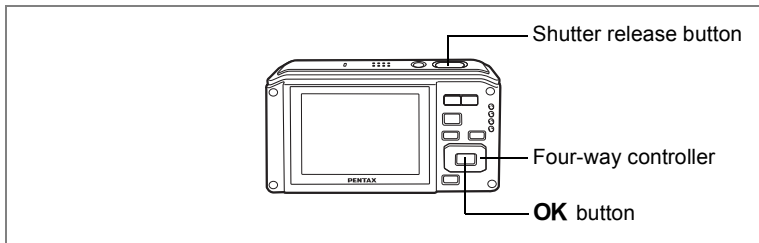

Setting The Functions (Program Mode)

In **P** (Program) mode, the shutter speed and the aperture are set automatically by the camera during shooting. However, you can select other functions such as the flash mode and recorded pixels.

- 1 Press the four-way controller (▼) in mode.**
The Capture Mode Palette appears.
- 2 Use the four-way controller (▲▼◀▶) to select **P** (Program).**
- 3 Press the OK button.**
- 4 Set the functions you want to use.**
Refer to “Setting the Shooting Functions” (p.100 - p.127) for details of how to set the functions.
- 5 Press the shutter release button halfway.**
The focus frame on the display turns green if the subject is in focus.
- 6 Press the shutter release button fully.**
The picture is taken.



Taking Still Pictures p.43

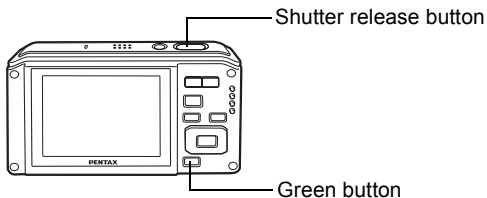

Taking Pictures in the Basic Mode (Green Mode)

In the **●** (Green) mode, you can enjoy easy picture-taking using standard settings*, regardless of the settings in the [📷 Rec.Mode] menu.

4

1 Press the Green button in 📷 mode.

The camera switches to **●** mode.

Press the Green button again to return to the status before **●** mode was selected.

2 Press the shutter release button halfway.

The focus frame on the display turns green if the subject is in focus.











3 Press the shutter release button fully.

The picture is taken.



- To use **●** mode, you must set it to the Green button on the Shooting menu. (p.121) * **●** mode is set as the default.
- In **●** mode, you cannot change the information on the display by pressing the **OK/DISPLAY** button.
- When the camera is turned off in **●** mode, it turns on in **●** mode next time the power switch is pressed.
- The Shooting menu cannot be displayed in **●** mode.

*  mode settings are as shown below.

Flash Mode	 (Auto)
Drive Mode	<input type="checkbox"/> (Standard)
Focus Mode	AF (Standard)
Information Display	Normal
Recorded Pixels	
Quality Level	★★ (Better)
White Balance	AWB (Auto)
Focusing Area	 (Multiple)
AE Metering	 Multi-segment metering
Sensitivity	AUTO 800
EV Compensation	±0.0
Blink Detection	<input checked="" type="checkbox"/> (On)
Digital Zoom	<input checked="" type="checkbox"/> (On)
Instant Review	1sec
Memory	Default
Sharpness	 (Normal)
Saturation	 (Normal)
Contrast	 (Normal)
Date Imprint	Off

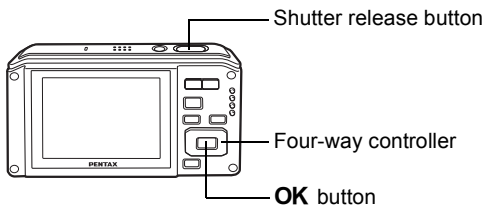

Taking Pictures of Dark Scenes (Night Scene/ Digital SR (Blur Reduction)/Fireworks Mode)

You can choose settings appropriate for taking pictures of dark scenes, such as nightscapes.

	Use this mode when taking pictures of night views.
	Use this mode to reduce blurring when taking pictures indoors or in low-light conditions.
	Use this mode to take spectacular pictures of fireworks.

- 1 Press the four-way controller (▼) in mode.**
The Capture Mode Palette appears.
- 2 Use the four-way controller (▲▼◀▶) to select (Night Scene), (Digital SR (Blur Reduction)) or (Fireworks).**
- 3 Press the OK button.**
The shooting mode is selected and the camera returns to capture status.
- 4 Press the shutter release button halfway.**
The focus frame on the display turns green if the subject is in focus.
- 5 Press the shutter release button fully.**
The picture is taken.





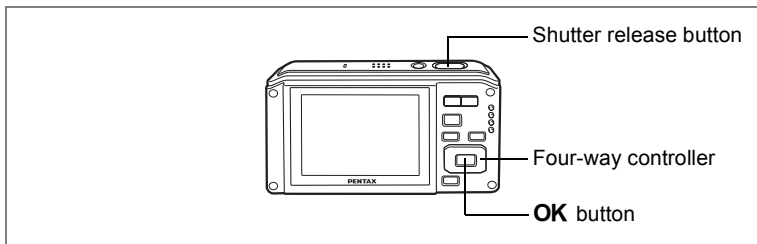





- The shutter speed tends to be slower when taking pictures of dark scenes.
- To prevent camera shake, use a tripod and/or the self-timer function. (p.87)
- In mode, the number of recorded pixels is fixed at (2592 × 1944).
- In mode, the sensitivity is fixed at AUTO 6400 (50 to 6400).
- For mode, the sensitivity is fixed at 50, the focus mode is , and the flash mode is . Also, the shutter speed is fixed at 4 seconds and the aperture is left open.
- In mode, AE metering is set to multi-segment metering.



Taking Underwater Pictures (Underwater Mode/ Underwater Movie Mode)

This camera has been proven to comply with JIS waterproof grade 8 and can be used to take pictures at a depth of 4 m continuously for 2 hours. In addition, this camera complies with JIS dustproof grade 5 (IP58).

	Use the Underwater mode to take underwater still pictures that capture the blueness of the sea.
	Use the Underwater Movie mode to record movies underwater.

- 1 Press the four-way controller (▼) in  mode.**
The Capture Mode Palette appears.
- 2 Use the four-way controller (▲▼◀▶) to select  (Underwater) or  (Underwater Movie).**
- 3 Press the OK button.**
The shooting mode is selected and the camera returns to capture status.
- 4 Press the shutter release button halfway.**
The focus frame on the display turns green if the subject is in focus.
- 5 Press the shutter release button fully.**
If you selected , the picture is taken.
If you selected , recording starts. To stop recording, press the shutter release button fully. Perform the same steps as  to record movies.

Recording a Movie  p.130



- Before taking pictures underwater, make sure that there is no dirt or sand on the waterproof packing of the battery/card/terminal cover and check that the cover is securely locked.
- Before opening the battery/card/terminal cover after using the camera underwater, make sure that there is no water, dirt or sand on the battery/card/terminal cover or anywhere else on the camera. Wipe the camera before opening the cover.
- In mode, AE metering is set to multi-segment metering.

Waterproof and Dustproof Function p.5



- The flash will not discharge in mode.
- When the Focus Mode is set to **AF**, , or , pictures are taken by pressing the shutter release button half-way down to lock the focus before shooting. However from the menu settings, you can select to continue adjusting the focus after focusing on a subject while recording movies (p.140).
- When the Focus Mode is set to **MF**, you can adjust the focus before recording starts and during recording.
- Optical and digital zoom in Underwater Movie are only available before recording starts. (Only digital zoom is available during recording.) However, optical zoom can also be made available by selecting it from the menu settings (p.141).
- You cannot change what is shown on the display by pressing the **OK/DISPLAY** button while recording a movie.

Setting the Optical Zoom p.141

Although the camera is provided with waterproof and dustproof functions, avoid using the camera under the following conditions. It may momentarily be subjected to water pressure beyond that covered in the guarantee and water may enter the interior of the camera.

- Jumping into the water while holding the camera
- Swimming while holding the camera in your hand
- Using the camera in environments where water is applied forcefully, such as strong river currents and waterfalls

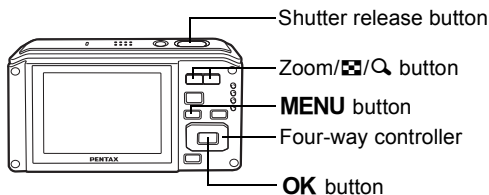

Framing Your Pictures (Frame Composite)

In  (Frame Composite) mode, you can take pictures using the frames stored in the camera.

1 Press the four-way controller () in mode.

The Capture Mode Palette appears.

2 Use the four-way controller (, , ,) to select (Frame Composite).

3 Press the OK button.

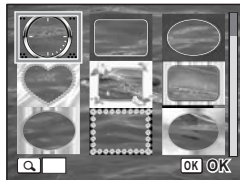

A 9-frame display of the frame selection screen appears.



4 Use the four-way controller (, , ,) to choose the frame you want to use.

5 Press the Zoom/Matrix/Quick button towards .

The selected frame appears in single-image display. You can choose another frame using either of the following operations.

- Use the four-way controller (, ) to choose a different frame.
- Press the Zoom/Matrix/Quick button towards  to return to 9-frame display of the selection screen, and then perform Step 4 to choose a different frame.

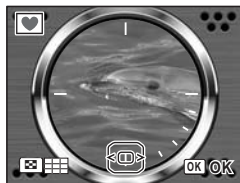

If no buttons are operated in single-image display, the displayed frame is selected. Repeat from Step 1 to select another frame.

6 Press the OK button.

The frame appears on the screen.

7 Press the shutter release button halfway.

The focus frame on the display turns green if the subject is in focus.

8 Press the shutter release button fully.

The picture is taken.



- In mode, recorded pixels is fixed at (2048×1536).
- 3 default frames and 77 optional frames are pre-installed at the factory. (the supplied CD-ROM provides over 80 frames, including the default frames.)

Optional Frame Images

Optional frames are stored in the Optio W60 built-in memory using the image, movie, and sound recording areas.



These optional frames may be deleted from built-in memory when file operations (delete, etc.) are performed from a computer. If these frames are deleted, recopy them from the supplied CD-ROM.

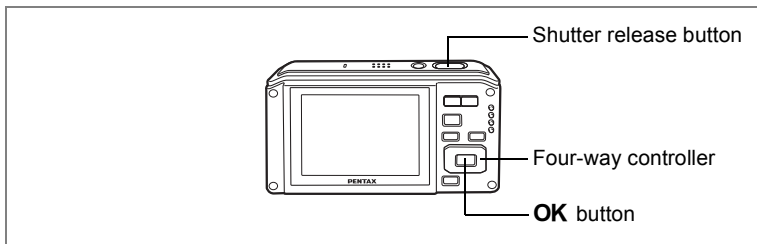

● Copy procedure:



1. Remove the SD memory card from the camera. (If the SD Memory Card is left in the camera, data is copied to the SD Memory Card instead of the built-in memory.)
 2. Connect the camera to the computer using a USB cable (I-USB7) while referring to the PC Connection Manual.
 3. When the camera is connected, the device detection screen automatically appears. Press [Cancel].
 4. Insert the supplied CD-ROM (S-SW81) into a computer.
 5. The install window automatically opens. Press the [EXIT] button to close the window.
 6. If the FRAME folder does not exist in the root directory of the camera (removable disk), create one from the computer.
 7. Perform file operations on the computer and copy the desired files from the FRAME folder in the root directory of the CD-ROM to the FRAME folder on the camera (removable disk). (For more information on computer file operations, refer to the user guide for your computer.)
 8. Disconnect the camera referring to the PC Connection Manual.
- * The 3 default frames are copied over and restored.
 - * To copy files to the SD memory card, leave the SD memory card inserted in Step 1 above.
 - * Frames can be recorded to both built-in memory and the SD memory card, but too many frames slows down processing.
 - * You can also copy only the frame files you need.



Taking Pictures of People (Portrait/Night Scene Portrait Mode)

 (Portrait) and  (Night Scene Portrait) modes are suitable for taking pictures of people. Face Recognition (p.59) operates for each shooting mode, making it easier to emphasize the subject's face when taking pictures.

	Use this mode when taking pictures of people.
	Use this mode when capturing portraits at night or in dark areas.

- 1 Press the four-way controller (▼) in  mode.**
The Capture Mode Palette appears.
- 2 Use the four-way controller (▲▼◀▶) to select either  (Portrait) or  (Night Scene Portrait).**
- 3 Press the OK button.**
The shooting mode is selected and the camera returns to capture status.
When the subject's face is recognized, a yellow focus frame appears on the display at the location of the face (when multiple faces are recognized, the main face is indicated in yellow). As the subject moves, the size and location of the focus frame change to match the location of the subject's face.
- 4 Press the shutter release button halfway.**
The focus frame on the display turns green if the subject is in focus.
- 5 Press the shutter release button fully.**
The picture is taken.



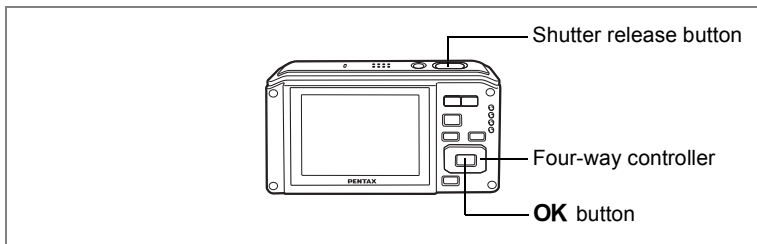

- If the camera cannot recognize the subject's face, the camera focuses using the Focusing Area currently selected.
- When Smile Capture is activated, the shutter will be released automatically when the camera recognizes the subject's smile. However, depending on the condition of the recognized faces, an image may not be captured automatically because the Smile Capture function will not work.



Zooming and Taking Pictures of People (Half-length Portrait Mode)

With  (Half-length Portrait), when a face is recognized within the image, the intelligent zoom works to zoom in for a portrait picture based on the position of the face and the size to give a photograph with the subject recorded from the waist up. Face Priority is always on in this mode.

- 1 Press the four-way controller (▼) in  mode.**
The Capture Mode Palette appears.
- 2 Use the four-way controller (▲▼◀▶) to select  (Half-length Portrait).**

- 3 Press the OK button.**

When the camera recognizes the subject's face, a yellow focus frame appears on the face and an orange frame indicating the area that will be enlarged appears.

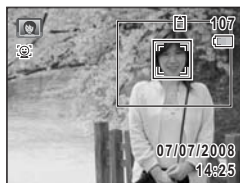

- 4 Press the shutter release button halfway.**

The focus frame on the display will light green when the camera is in focus. When a face is recognized, the camera automatically zooms to show the shooting area.



5 Press the shutter release button fully.

The picture is taken.



- When a subject's face cannot be recognized, an orange frame indicating the area to be enlarged is not displayed and the camera focuses using the selected Focusing Area.
- “Face Recognition AF” and “Face Recognition AE” may not work if the subject’s face is partly covered, for example, with sunglasses, or when the subject does not face the camera.
- The recordable image size is fixed at **[3M]** in Half-Length Portrait mode.

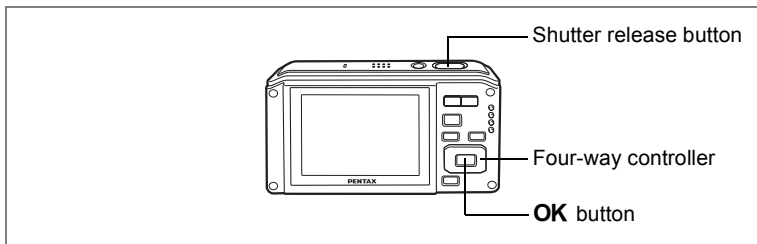

Taking Pictures of Your Pet (Pet Mode)

Use this mode to keep your moving pet in focus while you take the picture and capture the color of your pet's coat. Choose the appropriate icon depending on what color your pet is (closer to black or white or in between).

- 1 Press the four-way controller (▼) in mode.**
The Capture Mode Palette appears.
- 2 Use the four-way controller (▲▼◀▶) to select (Pet).**

- 3 Press the OK button.**
The Pet mode selection screen appears.
- 4 Use the four-way controller (▲▼) to select , , , , , or .**
There are two types of icons: a cat and dog icon.



- (Choosing either the cat or dog icon does not affect the resulting picture. Choose whichever you prefer.)
Choose an icon (white, gray, or black) whose tone best matches your pet's coat or fur.

- 5 Press the OK button.**
The Pet mode is selected and the camera returns to capture status.

- 6 Press the shutter release button halfway.**
The focus frame on the display turns green if the subject is in focus.



The focus frame follows the pet while the shutter release button is pressed halfway.

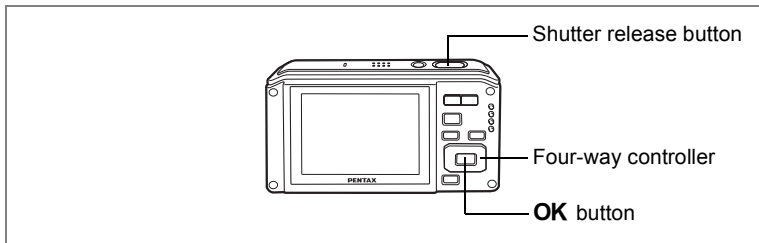

7 Press the shutter release button fully.

The picture is taken.



Taking Pictures of Children (Kids Mode)

 (Kids) mode is suitable for taking pictures of moving children. It also reproduces healthy and bright skin tone. Face Recognition (p.59) operates automatically for this mode, making it easier to emphasize the subject's face when taking pictures.

- 1 Press the four-way controller (▼) in  mode.**
The Capture Mode Palette appears.
- 2 Use the four-way controller (▲▼◀▶) to select  (Kids).**
- 3 Press the OK button.**

When the subject's face is recognized, a yellow focus frame appears on the display at the location of the face (when multiple faces are recognized, the main face is indicated in yellow). As the subject moves, the size and location of the focus frame change to match the location of the subject's face.



- 4 Press the shutter release button halfway.**
The focus frame on the display turns green if the subject is in focus.
- 5 Press the shutter release button fully.**
The picture is taken.



- Face Recognition AF and AE may not work if the subject is wearing sunglasses or has part of the face covered or if the subject is not looking toward the camera.
- If the camera cannot recognize the subject's face, the camera focuses using the Focusing Area currently selected.
- When Smile Capture is activated, the shutter will be released automatically when the camera recognizes the subject's smile. However, the Smile Capture function may not work and an image may not be captured depending on the condition of the recognized faces, such as the faces being too small.

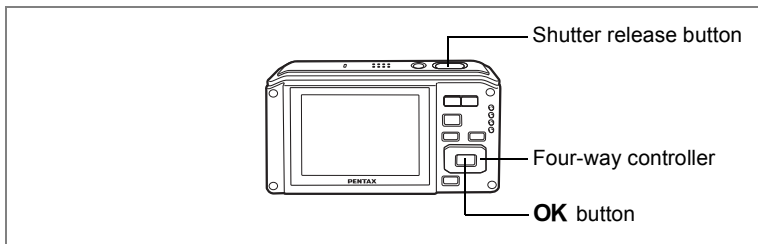

Taking Pictures of Text (Text Mode)

You can take pictures of text in documents or on a whiteboard so that the text is easy to read. Choose from four text modes.

	Color	A picture of the text is taken in its original color.
	Reversed Color	A picture of text is taken with the colors reversed.
	Black and White	A picture of the text is taken in black and white.
	Negative	A picture of text is taken with the black and white portions reversed.

- 1 Press the four-way controller (▼) in mode.**
The Capture Mode Palette appears.
- 2 Use the four-way controller (▲▼◀▶) to select (Text).**
- 3 Press the OK button.**
The text mode selection screen appears.
- 4 Use the four-way controller (▲▼) to select .**
- 5 Press the OK button.**
The text mode setting is saved and the camera returns to capture status.
- 6 Press the shutter release button halfway.**
The focus frame on the display turns green if the subject is in focus.
- 7 Press the shutter release button fully.**
The picture is taken.

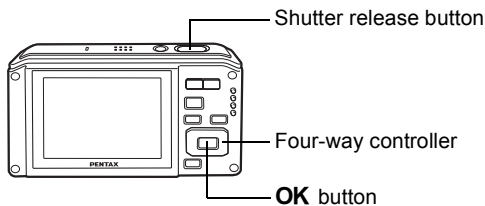

Taking Panoramic Pictures (Digital Panorama Mode)

4

Taking Pictures

In **▶▶▶** (Digital Panorama) mode, take two or three frames in sequence overlapping their edges by moving the camera horizontally. When the third frame is taken, the images taken in sequence are automatically stitched and the panoramic photograph is saved.

1 Press the four-way controller (▼) in **📷** mode.

The Capture Mode Palette appears.

2 Use the four-way controller (▲▼◀▶) to select **▶▶▶** (Digital Panorama).

3 Press the OK button.

The shooting mode is selected and the message “Set shift direction” is displayed.



4 Use the four-way controller (◀▶) to choose the direction in which the images will be joined.

The screen for taking the first frame is displayed.

5 Press the shutter release button halfway.

The focus frame on the display turns green if the subject is in focus.



6 Press the shutter release button fully.

The screen for taking the second frame is displayed after you take the first frame.



If you select right (▶) in Step 4:

The right edge of the first frame appears in semi-transparent form on the left edge of the display.

If you select left (◀) in Step 4:

The left edge of the first frame appears in semi-transparent form on the right edge of the display.

7 Move the camera horizontally to the selected direction and take the second frame.

Move the camera so that the semi-transparent image and the actual view overlap and press the shutter release button. Repeat Steps 5 to 7 to take the third frame.

8 The panorama stitching starts when the third frame is taken and the stitched image appears.

The stitched image does not appear when the Instant Review (p.44, p.120) is off.



- When the Face Recognition is activated (p.59), it works only when taking the first frame.
- If you press the **OK** button after shooting the first or second frame, you can save the captured image(s). (If you press the **OK** button after shooting the second frame, you can save the first and the second frames as a stitched image.)
- When you cancel shooting after shooting the first frame, the frame is saved at **[2M]** (1600×1200).

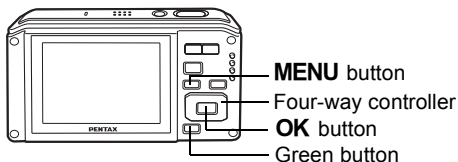

Using the Digital Wide Function (Digital Wide Mode)

4

WIDE (Digital Wide) mode can stitch two pictures taken into a 35 mm film conversion equivalent to a maximum of approx. 21 mm.

- 1 Press the four-way controller (▼) in  mode.**

The Capture Mode Palette appears.

- 2 Use the four-way controller (▲▼◀▶) to select  (Digital Wide).**

- 3 Press the OK button.**

Turn the camera 90° counterclockwise and compose your first picture.

- 4 Press the shutter release button halfway.**

The focus frame on the display turns green if the subject is in focus.

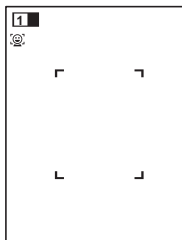

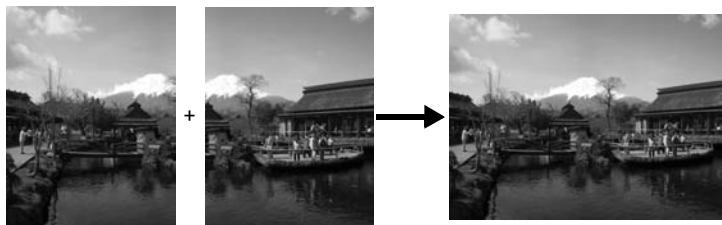

5 Press the shutter release button fully.

The first captured image is saved, and the shooting screen for the second image is displayed. Overlap the image on the preview guide on the left of the screen to compose your picture.

If you want to stop capturing images in the **WIDE** mode, go to step 7.

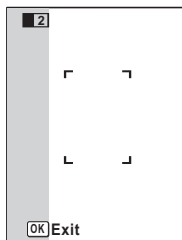

6 Press the shutter release button fully.

The combined image of the first and the second shot appears on the display for one second (Instant Review), and then it is saved in the built-in memory or on the SD Memory Card.

The stitched image does not appear when the Instant Review is off.



- For less distortion when taking the second picture, turn the camera to overlap the background and the preview guide on the left of the screen.
- Some distortion may result from moving objects, repeating patterns, or no objects in the overlapping area of the first and the second shot.
- When the Face Recognition is activated (p.59), it works only when taking the first image.
- The number of recorded pixels for images captured with **WIDE** mode is fixed at **5M** (2592×1944).
- **1cm** (1cm Macro) is unavailable in **WIDE** mode.

Save only the first image/Discard the first image and reshoot

Without taking a second image, you can save only the first image or discard it and take pictures starting with a new first image.

7 Press the **OK** button or the four-way controller (▼).

A confirmation dialog appears.

8 Use the four-way controller (▲▼) to select a process.

Save: Save the first image and start shooting from a new first image.
The first image is saved in **[3M]**.

Discard: Discard the first image and start shooting from a new first image.

Cancel: Return to the second image to be taken.

9 Press the **OK** button.

Either the first or second image taken is displayed depending on the selected process.

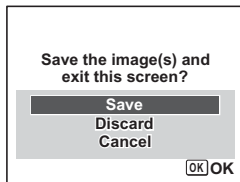

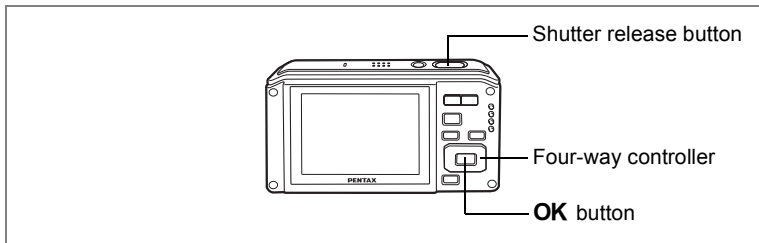

Using the Self-timer

In Self-timer mode, the picture is taken ten seconds or two seconds after the shutter release button is pressed.

Stabilize the camera with a tripod when taking a picture with the self-timer.

	Use this mode when you want to be included in a group picture. The picture is taken approximately ten seconds after the shutter release button is pressed.
	Use this mode to avoid camera shake. The picture is taken approximately two seconds after the shutter release button is pressed.

1 Press the four-way controller (▲) in mode.

2 Use the four-way controller (◀▶▼) to select or and press the OK button.

The camera is ready to take the picture using the self-timer.

3 Press the shutter release button halfway.

The focus frame on the display turns green if the subject is in focus.

4 Press the shutter release button fully.

The picture is taken ten seconds or two seconds later.



Focusing may be compromised if you move the camera while the self-timer lamp is blinking when taking still pictures.



- In (Movie) mode, recording will start after ten seconds (or two seconds).
- Press the shutter release button halfway while the self-timer is engaged to stop the countdown and press fully to restart the countdown.
- cannot be selected while (Green) mode is in default setting. Select in another shooting mode and then switch the shooting mode to .

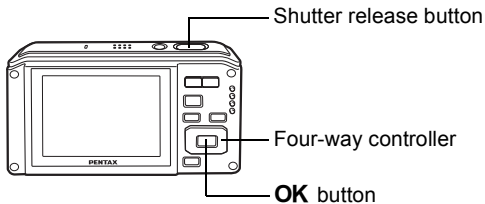



Taking a Series of Pictures (Continuous Shooting/ High Speed Continuous Shooting Mode)



4

Taking Pictures

In this mode, pictures are taken continuously as long as the shutter release button is pressed.

	<p>Continuous Shooting</p>	<p>Each time a picture is taken, the image is saved in the memory before the next image is taken. The higher the image quality, the longer the interval between shots. You can continue shooting until the memory capacity of the SD Memory Card or built-in memory is full.</p>
	<p>HS Cont. Shooting</p>	<p>Seven pictures are taken consecutively at 3.5 frames per second (5.3 frames per second when sensitivity is 3200 or 6400).</p>

1 Press the four-way controller (▲) in  mode.

2 Use the four-way controller (◀▶▼) to select  (Continuous Shooting) or  (HS Cont. Shooting) and press the OK button.

The camera is ready to take a series of pictures.



3 Press the shutter release button halfway.

The focus frame on the display turns green if the subject is in focus.

4 Press the shutter release button fully.

Pictures are taken continuously as long as you keep the shutter release button pressed.



- The flash does not discharge in Continuous Shooting/HS Cont. Shooting.
- (Continuous Shooting) and (HS Cont. Shooting) are unavailable in (Auto Picture), (Night Scene), (Movie), (Underwater Movie), (Fireworks), (Voice Recording), (Digital Panorama), and (Digital Wide) modes.



- The interval of Continuous Shooting varies according to the Recorded Pixels and Quality Level settings.
- The focus, exposure and white balance are locked with the first image.
- When the Face Recognition is activated (p.59), it works only when taking the first image.
- The number of recorded pixels is fixed at in HS Cont. Shooting. When the shooting mode is set to , the number of recorded pixels is set to (1280×960).

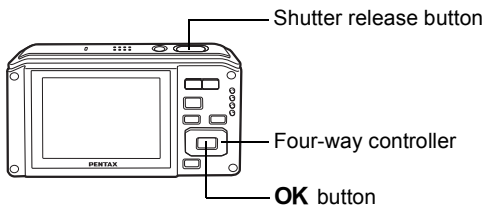

Taking Pictures at a Set Interval (Interval Shoot)

In this mode, a set number of pictures can be taken automatically at a set interval from a set time.

4

Interval	10 sec. – 99 min.	Set the camera to take pictures in one second increments from ten seconds to four minutes intervals or in one minute increments from four minutes to 99 minutes intervals. You cannot set the camera to take interval shots at intervals of less than ten seconds.
Number of Shot	2 shots – number of recordable images	You can set this to up to 1000 shots. However, this cannot exceed the number of recordable images.
Start Delay	0 min. – 24 hours	You can set one minute increments for the first 59 minutes and one hour increments from there. If the start time is set to 0 min., the first picture is taken as soon as the shutter release button is pressed.

1 Press the four-way controller (▲) in mode.

2 Use the four-way controller (◀▶) to select (Interval Shoot) and press the OK button.

The current interval shoot setting appears for approximately 1 minute. To take pictures with the current setting, go to Step 10.

3 Press the OK button while the setting is displayed.

The Interval Shoot setting screen appears. [Interval] is marked with the frame.



4 Set the interval.

- 1 Press the four-way controller (▶).
- 2 Use the four-way controller (▲▼) to set the minute, then press the four-way controller (▶).
- 3 Use the four-way controller (▲▼) to set the seconds, then press the four-way controller (▶).

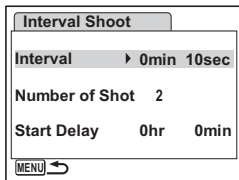

The frame returns to [Interval].

5 Press the four-way controller (▼).

The frame moves to [Number of Shot].

6 Set the number of shots.

- 1 Press the four-way controller (▶).
- 2 Use the four-way controller (▲▼) to set [Number of Shot], then press the four-way controller (▶).

The frame returns to [Number of Shot].

7 Press the four-way controller (▼).

The frame moves to [Start Delay].

8 Set the start delay.

- 1 Press the four-way controller (▶).
- 2 Use the four-way controller (▲▼) to set the hour, then press the four-way controller (▶).
- 3 Use the four-way controller (▲▼) to set the minute, then press the four-way controller (▶).

The frame returns to [Start Delay].

9 Press the OK button.

The Interval Shoot setting is saved and the camera returns to capture status.

10 Press the shutter release button halfway.

The focus frame on the display turns green if the subject is in focus.

11 Press the shutter release button fully.







Interval shooting starts.

The camera turns off between shots (during standby). Press the power switch during standby to display the remaining number of shots and interval on the display.

The [Stop interval shooting?] message is displayed when the power switch and then the **MENU** button are pressed during standby.

Pressing the **OK** button cancels interval shooting.



- Interval shooting is not available in **AUTO PICT**, , , , , or **WIDE** mode.
- Refer to p.137 to p.139 for instructions on interval shooting for , .
- Even if an alarm is set, the alarm will not ring while interval shooting is being performed.



The Interval Shoot settings can also be configured from the [ Rec.Mode] menu. (p.117)

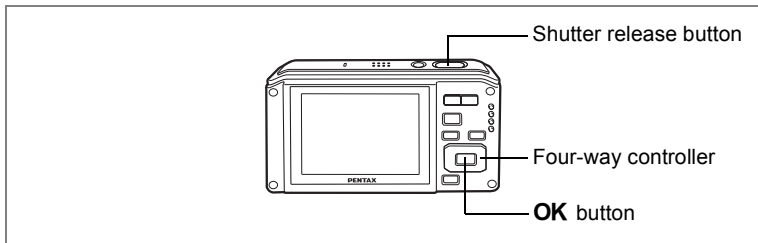

Taking Pictures with Automatic Exposure Adjustment (Auto Bracket)

Press the shutter release button once to automatically adjust the exposure and take three pictures in succession. After taking the pictures, you can select the best one.

The shooting order is best exposure → -1.0 EV → +1.0 EV.

- 1 Press the four-way controller (▲) in mode.**
- 2 Use the four-way controller (◀▶) to select (Auto Bracket) and press the OK button.**

The camera can now take pictures with Auto Bracket.

- 3 Press the shutter release button halfway.**

The focus frame on the display turns green if the subject is in focus.

- 4 Press the shutter release button fully.**

Press the shutter release button once to automatically adjust the exposure and take three pictures.



- When the Instant Review time is set (p.120), the third image taken is shown in Instant Review after shooting (p.44). However, the image cannot be deleted while in Instant Review even if the button is pressed.
- Auto Bracket is unavailable in (Movie), (Underwater Movie), (Voice Recording), (Auto Picture), (Green), (Fireworks), (Digital Panorama), (Digital Wide), and (Frame Composite) modes.

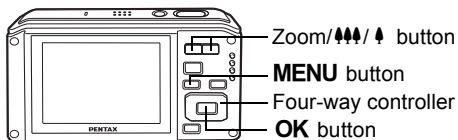

Using the Zoom

You can use the zoom to change the captured area.

1 Press the Zoom/▲▲▲/▲ button in mode.

Zoom lever (▲▲▲) : Diminishes the subject (Wide).

Zoom lever (▲) : Enlarges the subject.
If you continue to press the button, the camera automatically switches from optical zoom to intelligent zoom.

Once the button is released and pressed again, the camera switches to Digital Zoom.

If the Digital Zoom is set to off on the menu, the Optical Zoom and the Intelligent Zoom ranges are available for use. The zoom ratio of the intelligent zoom changes depending on the number of recorded pixels.

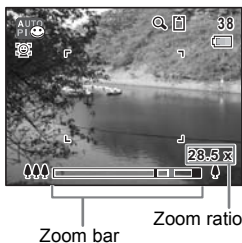

The zoom bar is displayed as follow.

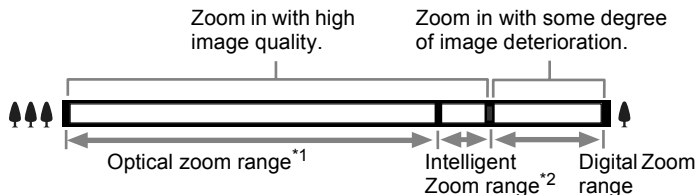

*1 You can zoom in to a maximum of 5× optically.

*2 The Intelligent Zoom range differs depending on the recorded pixels. See the following table.

Recorded pixels and the maximum zoom ratio

Recorded pixels	Intelligent Zoom	Digital Zoom
10M	Not Available (5× optical zoom available)	Equivalent to approx. 28.5×
7.5M	Not Available (5× optical zoom available)	
7M	Approx. 5.9×	
5M	Approx. 7.0×	
3M	Approx. 8.9×	
1280	Not Available (5× optical zoom available)	
1024	Approx. 17.8×	
640	Approx. 28.5× (Same as 28.5× Digital Zoom)	



- You are recommended to use a tripod to prevent camera shake when taking pictures at a high magnification rate.
- Pictures taken in the digital zoom range appear grainier than pictures taken in the optical zoom range.
- Intelligent Zoom is not available under the following conditions.
 - When the recorded pixels is set to **10M**, **7.5M**. (5× optical zoom available)
 - In (Movie) mode
 - In (Underwater Movie) mode
 - In (Digital SR) mode
 - In (Report) mode
 - When the sensitivity is set to 3200 or 6400.
- The image enlarged using Intelligent Zoom may appear rough on the display. This does not affect the quality of recorded image.
- The types of zoom available in and modes are Optical Zoom + Digital Zoom, Optical Zoom only, and Digital Zoom only (depends upon the menu settings).
- Intelligent Zoom is available regardless of whether Digital Zoom is turned on or off.
- The noise from the optical zoom is recorded if it is used when shooting in and modes.

Setting the Digital Zoom

The digital zoom is set to (On) in the default settings. To take pictures using only the optical zoom, set the digital zoom to (Off).

1 Press the MENU button in  mode.

The [ Rec.Mode] menu appears.

2 Use the four-way controller (▲▼) to select [Digital Zoom].

3 Use the four-way controller (◀▶) to select (On) or (Off).

The selected setting is saved.

4 Press the MENU button.

The setting is complete and the camera returns to capture status.

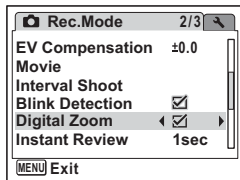

Saving the Digital Zoom Function Setting  p.128



Even if the digital zoom is set to off, intelligent zoom is available depending on the recorded pixels setting.

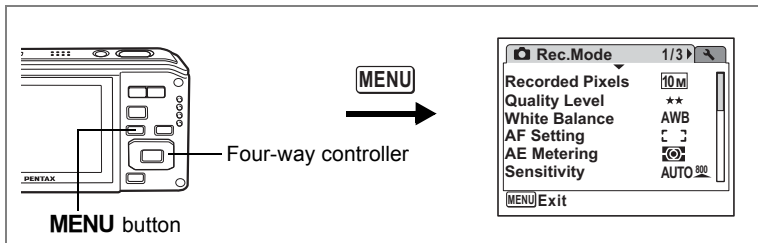

Setting the Exposure (EV Compensation)

You can adjust the overall brightness of the picture. Use this function to take pictures that are intentionally overexposed or underexposed.

1 Press the MENU button in mode.

The [Rec.Mode] menu appears.

2 Use the four-way controller () to select [EV Compensation].

3 Use the four-way controller () to select the EV value.

The selected EV value is saved.

To brighten, select a positive (+) value. To darken, select a negative (-) value.

You can choose the EV setting in the range of -2.0 EV to +2.0 EV in 1/3 EV steps.

4 Press the MENU button.

The setting is complete and the camera returns to capture status.

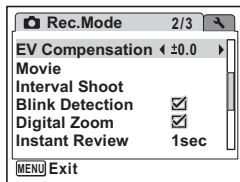

- When the histogram is displayed, bright portions and dark portions are indicated on the display, enabling you to check the exposure. (p.99)
- The EV compensation function cannot be used in (Auto Picture) or (Green) mode.

Saving the EV Compensation Value p.128

Displaying Shooting Information in Capture Mode

The display changes in the following sequence each time you press the **OK/DISPLAY** button: Normal Display, Histogram + Info, No Info, Backlight Off.

For details of each display mode, refer to “Monitor Indications” (p.21).



- All the camera buttons function as normal even when the backlight is off. Press the shutter release button to take pictures as normal.
- appears if you press the shutter release button halfway when camera shake is likely to occur. To prevent camera shake, use a tripod and/or the self-timer function. (p.87)
- In (Green) mode, you cannot change the information on the display by pressing the **OK/DISPLAY** button.

Normal Display



Histogram + Info



Backlight Off



No Info

Using the Histogram

A histogram shows the brightness distribution of an image. The horizontal axis represents brightness (dark at the left and bright at the right) and the vertical axis represents the number of pixels.

The shape of the histogram before and after shooting tells you whether the brightness and contrast are correct or not, and lets you decide if you need to use EV compensation and take the picture again.

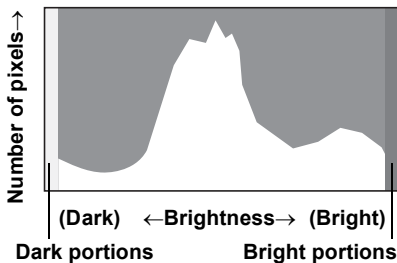

Setting the Exposure (EV Compensation) p.97

Understanding Brightness

If the brightness is correct, the graph peaks in the middle. If the image is too dark, the peak is on the left side, and if it is too bright, the peak is on the right side.

Dark image



Correct image

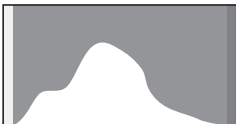

Bright image

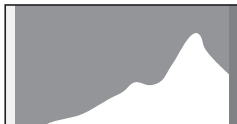

When the image is too dark, the part to the left is cut off (dark portions) and when the image is too bright, the part to the right is cut off (bright portions).

Bright portions blink red on the display and dark portions blink yellow.

Displaying Shooting Information in Capture Mode p.98

Displaying Shooting Information in Playback Mode p.148

Understanding Contrast

The graph peaks gradually for images in which contrast is balanced. The graph peaks on both sides but sinks in the middle for images with a large difference in contrast and low amounts of mid-level brightness.

Setting the Shooting Functions

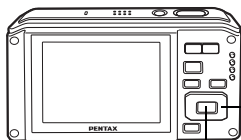





Four-way controller

OK button

4 Selecting the Focus Mode

Focus Mode

AF	Standard	Normally, use this mode for shooting. The camera is focused on the subject in the autofocus area when the shutter release button is pressed halfway.
	Macro	Used when taking close-ups. The camera is focused on the subject in the autofocus area when the shutter release button is pressed halfway. Pictures cannot be taken when the image is not focused.
	1cm Macro	Take pictures of the subject from a distance of 1 cm. Pictures cannot be taken when the image is not focused.
PF	Pan Focus	This mode is used when you ask someone to take pictures for you, or when taking pictures of the scenery through the window of a car or train. The entire picture, from the front to the back, is focused.
	Infinity	This mode is used for taking distant objects. The flash is set to  (Flash Off).
MF	Manual Focus	This mode lets you adjust the focus manually.

1 Press the four-way controller (▶) in mode.

The focus mode changes each time the button is pressed. You can also change the setting using the four-way controller (▲▼).

2 Press the shutter release button halfway.

The Focus Mode setting is saved and the camera returns to capture status.

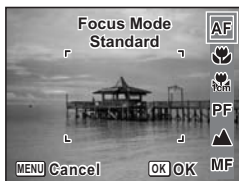



- In **AF** (Green) mode, you can only select **AF**, or **PF**.
- is unavailable in **Wide** (Digital Wide) mode.
- The noise from focusing is recorded when a focus mode other than **PF** or is selected in and modes.
- When **AF** is selected and the focus limiter is set to (Off) (p.116), if the subject is closer than 50 cm, the camera automatically focuses from 10 cm (Auto-Macro function).
- When shooting with selected, if the subject is further than 60 cm away, the camera automatically focuses to infinity.

Saving the Focus Mode p.128

Manual Focus

The procedure for setting the focus manually (**MF**) is described below.

1 Press the four-way controller (▶) in mode.

2 Use the four-way controller (▶) to select MF and press the OK button.

The central portion of the image is magnified to fill the screen of the display when focusing.

3 Press the four-way controller (▲▼).

The **MF** indicator appears on the display to indicate the approximate distance to the subject. Use the four-way controller (▲▼) to adjust the focus using the indicator as a guide.

▲ : for distant focus

▼ : for closer focus

4 Press the OK button.

The focus is fixed and the camera returns to capture status.

In addition, the focus position is fixed one minute after you remove your finger from the four-way controller (▶).

After the focus is fixed, you can press the four-way controller (▶) again to display the **MF** bar and readjust the focus.

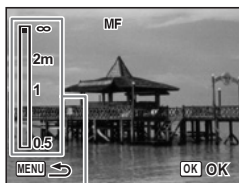
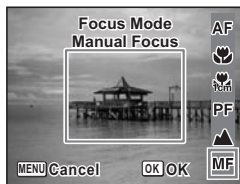

MF indicator



To switch from **MF** to another focus mode, press the four-way controller (▶) while the **MF** bar is displayed.



Capture mode and drive mode cannot be changed while the **MF** bar is displayed.

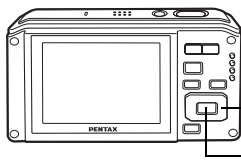

Four-way controller

OK button

Selecting the Flash Mode

Flash Modes

	Auto	The flash discharges automatically depending on the light conditions.
	Flash Off	The flash does not discharge, regardless of the brightness. Use this mode to take pictures where flash photography is prohibited.
	Flash On	The flash discharges regardless of the brightness.
	Auto + Red-eye	This mode reduces the phenomenon of red eyes caused by the light from the flash being reflected in the subject's eyes. The flash discharges automatically.
	Flash On + Red-eye	This mode reduces the phenomenon of red eyes caused by the light from the flash being reflected in the subject's eyes. The flash discharges regardless of the light conditions.
	Soft Flash	This mode reduces the intensity of the flash so that the flash is not too bright even when fired at close range. The flash discharges regardless of the light conditions.



- The flash mode is set to (Flash Off) in (Movie) or (Underwater Movie) modes, when the drive mode is (Continuous Shooting) or (HS Cont. Shooting), or when the focus mode is set to (Infinity).
- A pre-flash discharges when using the red-eye reduction function.
- In (Green) mode, you can only select or .
- In (Night Scene) mode, you cannot select and .



Using the flash when capturing images at a close distance may cause irregularities in the image due to the light distribution.

1 Press the four-way controller (◀) in  mode.



The flash mode changes each time the button is pressed. You can also change the setting using the four-way controller (▲▼).

2 Press the OK button.

The camera returns to capture status with the selected flash mode.



[About the red-eye phenomenon]

Taking pictures using the flash may cause the subject's eyes to appear red in the resulting picture. This phenomenon occurs when the light from the flash is reflected in the subject's eyes. It can be reduced by illuminating the area around the subject or moving closer to the subject and zooming out to a wider angle. Setting the flash mode to  (Auto + Red-eye) or  (Flash On + Red-eye) is also an effective way of reducing red eyes.

If the subject's eyes appear red despite such precautions, they can be corrected by the red-eye compensation function (p.172).

Saving the Flash Mode  p.128

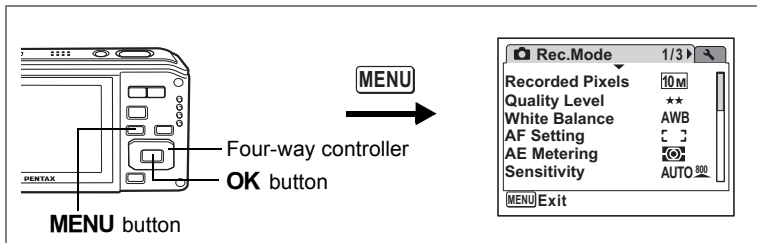

Selecting the Recorded Pixels

You can choose from eight recorded pixels settings for still pictures.

The larger your recorded pixels, the clearer the details will appear when you print your picture. As the quality of the printed picture also depends on the image quality, exposure control, resolution of the printer and other factors, you do not need to select more than the required number of recorded pixels. **3M** (2048×1536) is adequate for making postcard-size prints. The more recorded pixels there are, the larger the picture and the bigger the file size. The file size also varies depending on the quality level setting (p.107).

Recorded Pixels

Recorded Pixels	Use
10M 3648×2736	↑ For printing high quality photos or A4-size pictures or larger, or editing images on a computer. Matching the aspect ratio to HDTV produces undistorted pictures.
7.5M (16:9) 3648×2056	
7M 3072×2304	For making postcard-size prints.
5M 2592×1944	
3M 2048×1536	For posting on a website or attaching to e-mail.
1280 1280×960	
1024 1024×768	
640 640×480	

- Selecting **7.5M** changes the horizontal aspect ratio of the image to 16:9.
- Only **1280** (1280×960) can be set for recorded pixels when (Report) mode is set.

1 Press the **MENU** button in mode.

The [ Rec.Mode] menu appears.

2 Use the four-way controller () to select [Recorded Pixels].

3 Press the four-way controller () .

A pull-down menu appears.

4 Use the four-way controller () to change the number of recorded pixels.

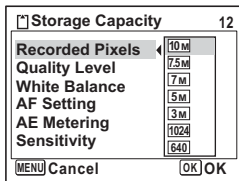







5 Press the **OK** button.

The Recorded Pixels setting is saved.

6 Press the **MENU** button.

The camera returns to capture status with the current setting.



- Images taken in  (Frame Composite) mode are fixed at **3M**.
- The number of recorded pixels for images captured in  (Digital Wide) or  (Digital SR) mode is fixed at **5M**. (However, the number of recorded pixels will be **3M** if you exit the Digital Wide mode without taking the second picture.)
- If you take and save only the first frame in  (Digital Panorama) mode, the number of recorded pixels fixed at **2M**.
- When drive mode is set to , the number of recorded pixels is set to **5M** (2592×1944), and when the shooting mode is set to , the number of recorded pixels is set to **1280** (1280×960).

Recorded Pixels and Quality Level of Still Pictures  p.34

Shooting and Playback Screens When **7.5M** Is Selected

Selecting **7.5M** changes the horizontal aspect ratio of the image to 16:9.

The shooting screen is shown on the right.



Shooting screen

Pressing the **OK/DISPLAY** button on this screen switches the display of shooting information in the same manner as when another number of recorded pixels is selected. (p.98, p.148)



Playback screen

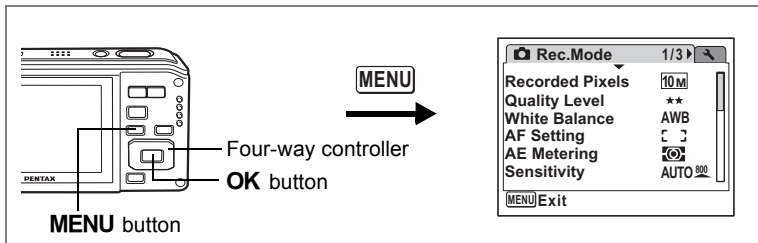

Selecting the Quality Level

You can select the quality (compression rate) of still pictures. The more ★, the lower the compression rate and the clearer the picture, but the file size becomes larger. The file size also varies depending on the recorded pixels setting (p.104).

Quality Level

★★★	Best	Lowest compression rate. Suitable for photo prints.
★★	Better	Standard compression rate. Suitable for viewing the image on a computer screen.
★	Good	Highest compression rate. Suitable for posting on a website or attaching to e-mail.

- 1 Press the MENU button in mode.**
The [Rec.Mode] menu appears.
- 2 Use the four-way controller (▲▼) to select [Quality Level].**
- 3 Press the four-way controller (▶).**
A pull-down menu appears.
- 4 Use the four-way controller (▲▼) to change the quality level.**
- 5 Press the OK button.**
The Quality Level setting is saved.
- 6 Press the MENU button.**
The camera returns to capture status with the current setting.

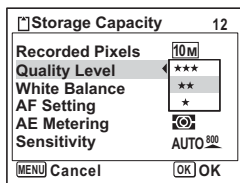

Recorded Pixels and Quality Level of Still Pictures p.34

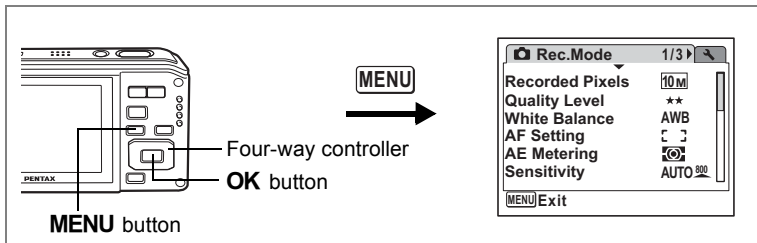

Adjusting the White Balance

You can take pictures in natural colors by adjusting the white balance according to the light conditions at the time of shooting.

White Balance

AWB	Auto	Adjusted automatically by the camera.
	Daylight	Use this mode when taking pictures outside in sunlight.
	Shade	Use this mode when taking pictures outside in the shade.
	Tungsten Light	Use this mode when taking pictures under electric or other tungsten light.
	Fluores. Light	Use this mode when taking pictures under fluorescent light.
	Manual	Use this mode when adjusting the white balance manually.



- Set another white balance if you are not satisfied with the color balance of pictures taken with white balance set to **AWB** (Auto).
- Depending on the selected shooting mode, the white balance setting may not be changed. Refer to p.218 - p.221 for details.

- 1 Press the MENU button in mode.**
The [Rec.Mode] menu appears.
- 2 Use the four-way controller () to select [White Balance].**

3 Press the four-way controller (▶).

The White Balance screen appears.

4 Use the four-way controller (▲▼) to change the setting.

5 Press the OK button.

The White Balance setting is saved.

6 Press the MENU button.

The camera returns to capture status with the current setting. Refer to “Manual Setting” below for instructions on adjusting the white balance manually.

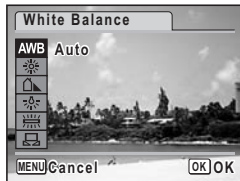

Saving the White Balance p.128

Manual Setting

Have a blank sheet of white paper or similar material ready.

1 In the White balance screen, use the four-way controller (▲▼) to select (Manual).

2 Point the camera at the blank sheet of paper or other material so that it fills the frame displayed in the center of the screen.

3 Press the shutter release button fully.

The white balance is automatically adjusted.

4 Press the OK button.

The setting is saved and the screen returns to the [Rec.Mode].

5 Press the MENU button.

The camera returns to capture status.

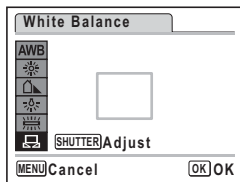

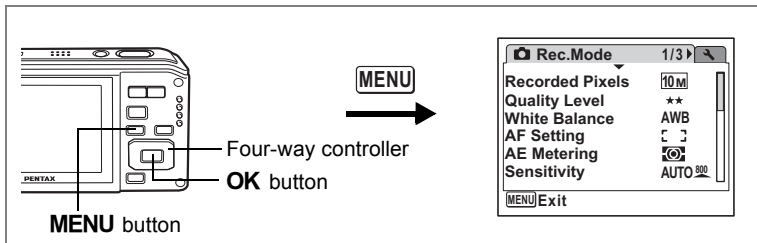

Setting the AE Metering

You can set the area of the screen where the brightness is metered to determine the exposure.

AE Metering

	Multi-segment metering	The camera divides the image into 256 areas, meters the brightness and determines the exposure.
	Center-weighted metering	The camera takes a reading of the overall brightness of the picture with the center of the image having more influence on the exposure.
	Spot AE metering	The camera determines the exposure by metering the brightness only at the center of the image.

- 1 Press the MENU button in mode.**
The [Rec.Mode] menu appears.
- 2 Use the four-way controller () to select [AE Metering].**
- 3 Press the four-way controller ().**
A pull-down menu appears.
- 4 Use the four-way controller () to select the AE Metering setting.**
- 5 Press the OK button.**
The AE Metering setting is saved.
- 6 Press the MENU button.**
The camera returns to capture status with the current setting.

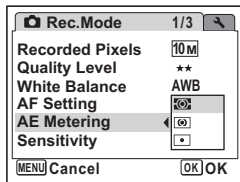



- When the shutter release button is pressed halfway, the brightness is metered and the exposure is determined.
- When the subject is outside the focusing area and you want to use spot AE metering, aim the camera at the subject and press the shutter release button halfway to lock the exposure, then compose your picture again and press the shutter release button fully.
- Depending on the selected shooting mode, the AE metering setting may not be changed. Refer to p.218 - p.221 for details.

Saving the AE Metering  p.128

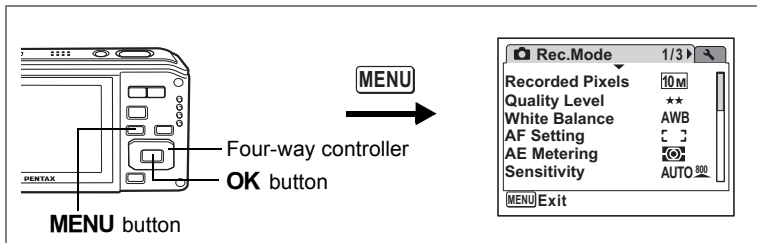

Setting the Sensitivity

Sensitivity is a value indicating how much the image sensor senses light. Low value equals low sensitivity and high value equals high sensitivity. Sensitivity can be adjusted according to the shooting situations.

Sensitivity

AUTO	AUTO 800 (50 - 800) is selected by default. You can also set ISO Correction in AUTO to 50 - 100, 50 - 200, 50 - 400, 50 - 800 or 50 - 1600. (The camera automatically sets itself 50 - 6400 in Digital SR mode.)
50	<ul style="list-style-type: none"> • The lower the sensitivity, the less noise that affects the image. The shutter speed will be slower in low light conditions. • Higher sensitivity settings use faster shutter speeds in low light conditions to reduce camera shake, but the image may be affected by noise.
100	
200	
400	
800	
1600	
3200	
6400	

1 Press the MENU button in mode.

The [Rec.Mode] menu appears.

2 Use the four-way controller (▲▼) to select [Sensitivity].

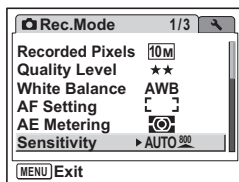

3 Press the four-way controller (▶).

The pull-down menu appears.

4 Use the four-way controller (▲▼) to select the sensitivity.

When [400] is highlighted, press the four-way controller (▼) to display [800], [1600], [3200], and [6400].

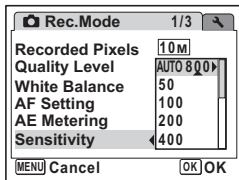

Selecting the Sensitivity







5 Press the OK button.

The sensitivity setting is saved.

6 Press the MENU button.

The camera returns to capture status with the current setting.



- When the shooting mode is set to , the camera automatically adjusts from 50 to 6400. The values can be changed.
- When the shooting mode is set to , only AUTO 6400 (50-6400) is available.
- ISO sensitivity is set to 50 when shooting mode is set to . Other values cannot be set.
- [3200] and [6400] are unavailable when  is selected for recorded pixels.
- When Sensitivity is set to 3200 or 6400, the number of recorded pixels is fixed at .
- When the shooting mode is set to  (Movie) or  (Underwater Movie), only AUTO (sensitivity 50 - 800) is available.

Selecting the Sensitivity and Correction Range

5 Select [AUTO] and press the four-way controller (▶).

The ISO Correction in AUTO range selection screen appears.

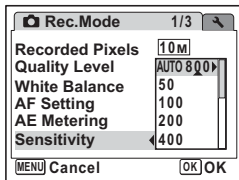

6 Press the four-way controller (▲▼◀▶) to select a range.



7 Press the OK button twice.

The AUTO Adjustment Range setting is saved.

8 Press the MENU button.

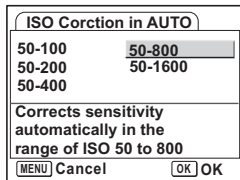
The camera returns to capture status with the current setting.



- Even if you set Sensitivity to Off in Memory, the selected range for ISO Correction in AUTO is saved when the camera is turned off. The selected sensitivity will be saved only when you set Sensitivity to On in Memory.
- When the shooting mode is set to , the AUTO adjustment range for sensitivity is from 50 to 6400. However, these values can be changed.
- When the shooting mode is set to  (Digital SR), only AUTO 6400 (sensitivity 50 - 6400) is available.

Saving the sensitivity  p.128

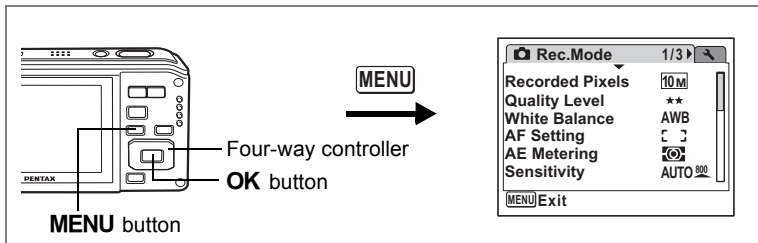

Setting the Autofocus Conditions

You can set various conditions for autofocus.

- 1 Press the MENU button in mode.**
The [Rec.Mode] menu appears.
- 2 Use the four-way controller () to select [AF Setting].**
- 3 Press the four-way controller ().**
The AF Setting screen appears.

Setting the Focusing Area

You can change the autofocus area (Focusing Area).

Focusing Area

	Multiple	Normal autofocus area
	Spot	The autofocus area becomes smaller.
	Automatic Tracking AF	Keeps moving subjects in focus.

- 4 Press the four-way controller ().**
The pull-down menu appears.
- 5 Use the four-way controller () to change the Focusing Area.**
- 6 Press the OK button.**
The AF Setting is saved.
- 7 Press the MENU button twice.**
The camera returns to capture status with the current setting.

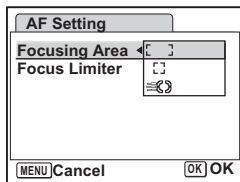

Setting the Focus Limiter

You can limit the focusing range of the lens in accordance with the shooting conditions.

When you set the [Focus Limiter] to [(On)], the focusing range of the lens is limited to the long range side for normal shooting and to the close-up side for macro shooting. This makes focusing faster.

4 Use the four-way controller (▲▼) to select [Focus Limiter].

5 Use the four-way controller (◀▶) to select [(On)/ (Off)].

6 Press the MENU button twice.

The camera returns to capture status with the current setting.

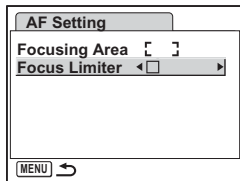

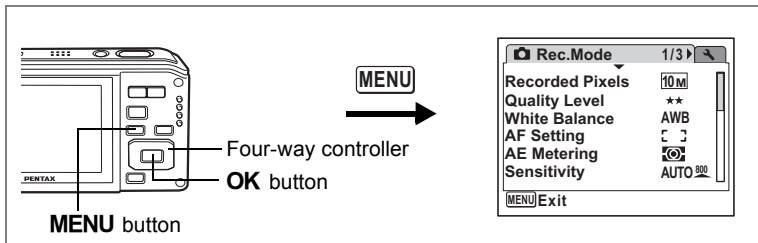

Setting Interval Shoot

In this mode, a set number of pictures can be taken automatically at a set interval from a set time.

Interval	10 sec. – 99 min.	Set the camera to take pictures in one second increments from ten seconds to four minutes intervals or in one minute increments from four minutes to 99 minutes intervals. You cannot set the camera to take interval shots at intervals of less than ten seconds.
Number of Shot	2 shots – number of recordable images	You can set this to up to 1000 shots. However, this cannot exceed the number of recordable images.
Start Delay	0 min. – 24 hours	You can set one minute increments for the first 59 minutes and one hour increments from there. If the start time is set to 0 min., the first picture is taken as soon as the shutter release button is pressed.

1 Press the **MENU** button in **Rec.Mode**.

The [Rec.Mode] menu appears.

2 Use the four-way controller (▲▼) to select [Interval Shoot].

3 Press the four-way controller (▶).

The Interval Shoot setting screen appears. [Interval] is marked with the frame.

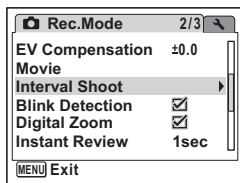

4 Set the interval.

- 1 Press the four-way controller (▶).
- 2 Use the four-way controller (▲▼) to set the minute, then press the four-way controller (▶).
- 3 Use the four-way controller (▲▼) to set the seconds, then press the four-way controller (▶).

The frame returns to [Interval].

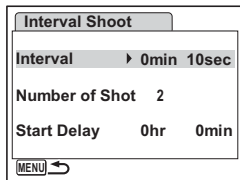

5 Press the four-way controller (▼).

The frame moves to [Number of Shot].

6 Set the number of shots.

- 1 Press the four-way controller (▶).
- 2 Use the four-way controller (▲▼) to set [Number of Shot], then press the four-way controller (▶).

The frame returns to [Number of Shot].

7 Press the four-way controller (▼).

The frame moves to [Start Delay].

8 Set the start delay.

- 1 Press the four-way controller (▶).
- 2 Use the four-way controller (▲▼) to set the hour, then press the four-way controller (▶).
- 3 Use the four-way controller (▲▼) to set the minute, then press the four-way controller (▶).

The frame returns to [Start Delay].

9 Press the MENU button twice.

The Interval Shoot setting is saved and the camera returns to the shooting screen. The operations up to this point have only configured the Interval Shoot settings. To actually use Interval Shoot, you must select [Interval Shoot] from Drive Mode.

Taking Pictures at a Set Interval (Interval Shoot) p.90



- Interval shooting is not available in , , , , or mode.
- Refer to p.137 to p.139 for instructions on interval shooting for and .
- Even if an alarm is set, the alarm will not ring while interval shooting is being performed.



The Interval Shoot settings can also be configured from the Drive Mode. (p.90)

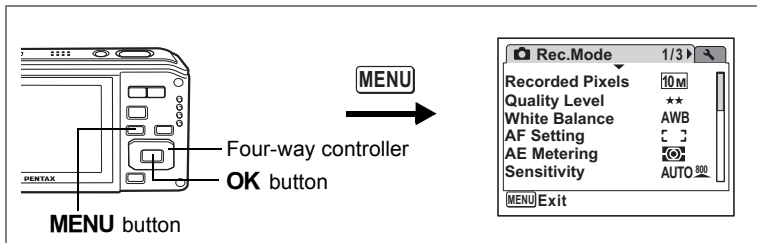

Setting the Instant Review Time (Instant Review)

You can choose the Instant Review time (the length of time the image is displayed immediately after capture) from 0.5sec, 1sec, 2sec, 3sec, 4sec, 5sec and Off (no display).

4

Taking Pictures

1 Press the MENU button in mode.

The [Rec.Mode] menu appears.

2 Use the four-way controller (▲▼) to select [Instant Review].

3 Press the four-way controller (▶).

A pull-down menu appears.

4 Use the four-way controller (▲▼) to change the display time.

5 Press the OK button.

The Instant Review setting is saved.

6 Press the MENU button.

The camera returns to capture status with the current setting.

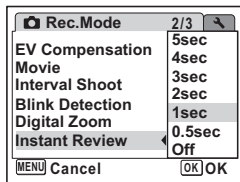

Instant Review p.44



If the Face Recognition function worked when shooting, Blink Detection will operate during Instant Review (p.61).

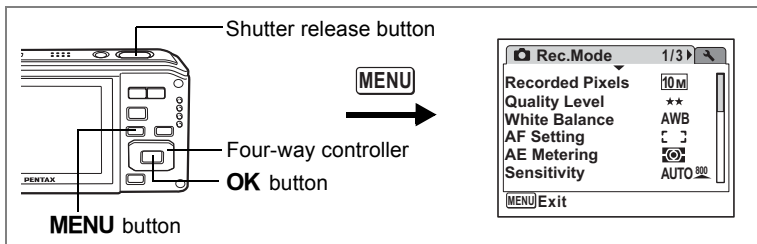

Setting the Green Button

You can assign one of the following functions to the Green button; [Green Mode] (p.66) and [Fn Setting] (p.122). You can activate the assigned function by just pressing the Green button.

Assigning a Function (Green Mode)

- 1 Press the **MENU** button in mode.

The [Rec.Mode] menu appears.

- 2 Press the four-way controller () to select [**Green Button**].

- 3 Press the four-way controller ().

The Green button setting screen appears.

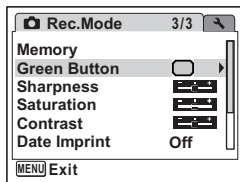

- 4 Use the four-way controller () to select the function you want to register.

- 5 Press the **OK** button.

The Green Button setting is saved.

- 6 Press the **MENU** button.

The camera returns to capture status with the current setting.

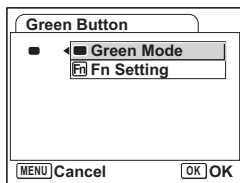

Green Mode is registered as the default setting.

Registering Frequently Used Functions (Fn Setting)

You can register frequently used functions on the four-way controller. Using this function, you can directly set the functions by pressing the four-way controller without displaying the menu in Capture mode. In [Fn Setting], still picture mode and Movie mode have different settings. To execute [Fn Setting] for Movie mode, press **MENU** button in Movie mode in Step 1 on page 121.

4 Use the four-way controller (▲▼) to select [Fn Setting].

5 Press the OK button.

The Fn Setting screen appears.

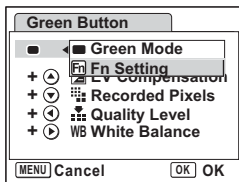

6 Use the four-way controller (▲▼) to select a key you want to assign a function to.

7 Press the four-way controller (▶).

The pull-down menu appears.

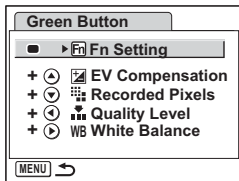

8 Use the four-way controller (▲▼) to select a function you want to assign.

9 Press the OK button.

10 Press the MENU button twice.

The camera returns to capture status with the current setting.

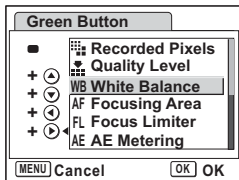

This function is activated only when you assign the Fn Setting to the Green button.



You can assign only one function to each key.

The initial settings for Fn Setting

	still picture mode	Movie mode
Initial settings	(▲) EV Compensation	(▲) Movie SR
	(▼) Recorded Pixels	(▼) EV Compensation
	(◀) Quality Level	(◀) Recorded Pixels
	(▶) White Balance	(▶) White Balance

Functions that can be registered on Fn Setting

	still picture mode	Movie mode
Setting items	Recorded Pixels	Recorded Pixels
	Quality Level	Color Mode
	White Balance	Movie SR
	Focusing Area	White Balance
	Focus Limiter	Focusing Area
	AE Metering	EV Compensation
	Sensitivity	Sharpness
	EV Compensation	Saturation
	Sharpness	Contrast
	Saturation	
	Contrast	

Changing Registered Functions

Press the Green button in the shooting mode to display the Fn Setting screen. Select an item with the four-way controller ▲▼◀▶, and press either the ▲▼ or ◀▶ four-way controller to change the settings.

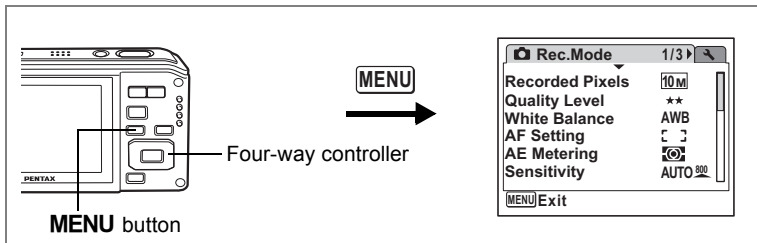

Setting the Image Sharpness (Sharpness)

Select either sharp or soft outlines for the image.

4

Taking Pictures

1 Press the MENU button in mode.

The [Rec.Mode] menu appears.

2 Use the four-way controller (▲▼) to select [Sharpness].

3 Use the four-way controller (◀▶) to change the sharpness level.

The following setting is saved.

— · + (Soft)

— · + (Normal)

— · + (Sharp)

4 Press the MENU button.



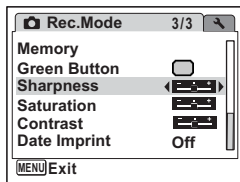

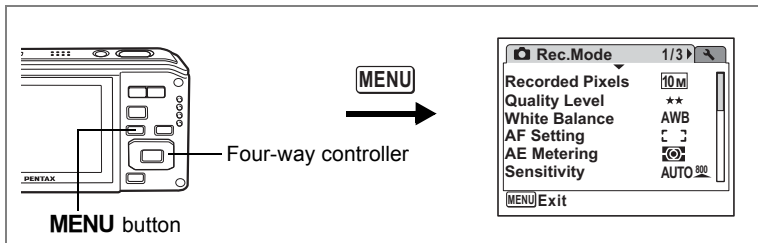

The Sharpness setting is saved and the camera returns to capture status.







Setting the Color Saturation (Saturation)

You can set the color saturation.

- 1 Press the MENU button in  mode.**
The [ Rec.Mode] menu appears.
- 2 Use the four-way controller ( ) to select [Saturation].**
- 3 Use the four-way controller ( ) to change the saturation level.**

The following setting is saved.

-  (Low)
-  (Normal)
-  (High)

- 4 Press the MENU button.**

The Saturation setting is saved and the camera returns to capture status.

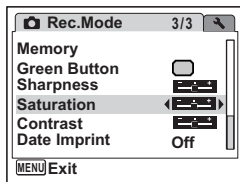

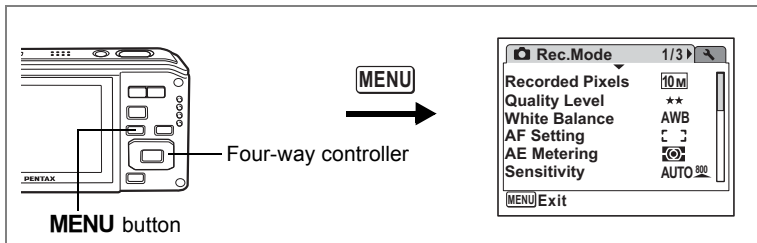

Setting the Image Contrast (Contrast)



You can set the image contrast level.

4

- 1 Press the MENU button in  mode.**

The [ Rec.Mode] menu appears.

- 2 Use the four-way controller ( ) to select [Contrast].**

- 3 Use the four-way controller ( ) to change the contrast level.**

The following setting is saved.

 (Low)

 (Normal)

 (High)

- 4 Press the MENU button.**

The Contrast setting is saved and the camera returns to capture status.

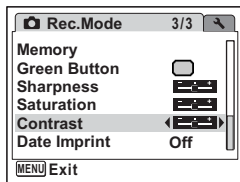

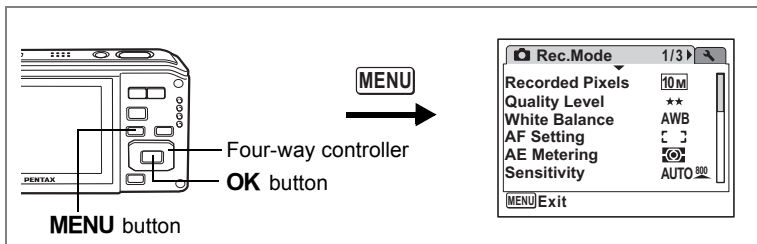

Setting the Date Imprint Function

For choosing whether to imprint the date and time when taking still pictures.

1 Press the MENU button in mode.

The [Rec.Mode] appears.

2 Use the four-way controller () to select [Date Imprint].

3 Press the four-way controller ().

A pull-down menu appears.

4 Select either [Date], [Date & Time], [Time], or [Off] with the four-way controller ().

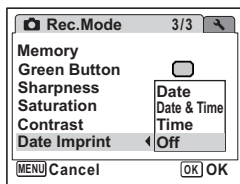

5 Press the OK button.

The Date Imprint setting is saved.

6 Press the MENU button.

The camera returns to capture status with the current setting.













Caution

- The **DATE** screen appears if other than [Off] was selected in Step 4.
- The date imprinted with the Date Imprint function cannot be deleted.
- The date and time are imprinted on the picture with the date style set on the Date Adjust screen.
- Note that when the printer or the image editing software is set to print the date and when printing images with the date imprinted, the date may be printed twice.
- In Green Mode, the date is not imprinted regardless of the Date Imprint setting.

Saving the Settings (Memory)

The Memory function is for saving the current camera settings when the camera is turned off.

For some camera settings, the Memory function is always set to (On) (the settings are saved when the camera is turned off), while for others you can choose on or off (to choose whether the settings are saved or not when the camera is turned off). The items which can be set to (On) or (Off) in the Memory function are shown in the table below. (Items not listed here are always saved in the selected settings when the camera is turned off.) If you select (On), the settings will be saved in the status they were in immediately before the camera was turned off. If you select (Off), the settings will be reset to the defaults when the camera is turned off. The table below also shows whether the Memory default setting for each item is on or off.

Item	Description	Default Setting
Face Priority	A Face Recognition mode set by using the  button (p.59)	<input type="checkbox"/>
Flash Mode	The flash mode set with the four-way controller () (p.102)	<input checked="" type="checkbox"/>
Drive Mode	The drive mode set with the four-way controller () (p.87 - p.93)	<input type="checkbox"/>
Focus Mode	The focus mode set with the four-way controller () (p.100)	<input type="checkbox"/>
Zoom Position	The zoom position set with the Zoom/  button (p.94)	<input type="checkbox"/>
MF Position	The manual focus position set with the four-way controller ( ) (p.101)	<input type="checkbox"/>
White Balance	The [White Balance] setting on the [ Rec.Mode] menu (p.108)	<input type="checkbox"/>
Sensitivity	The [Sensitivity] setting on the [ Rec.Mode] menu (p.112)	<input type="checkbox"/>
EV Compensation	The [EV Compensation] setting on the [ Rec.Mode] menu (p.97)	<input type="checkbox"/>
AE Metering	The [AE Metering] setting on the [ Rec.Mode] menu (p.110)	<input type="checkbox"/>
Digital Zoom	The [Digital Zoom] setting on the [ Rec.Mode] menu (p.96)	<input checked="" type="checkbox"/>
DISPLAY	The display information display mode set with the OK/ DISPLAY button (p.98, p.148)	<input type="checkbox"/>
File No.	If a new SD Memory Card is inserted when On has been selected, file numbers are assigned sequentially	<input checked="" type="checkbox"/>

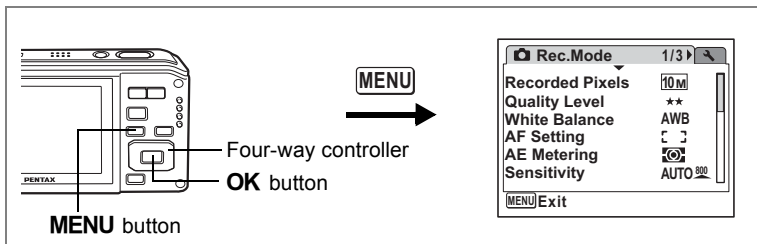

- 1 Press the MENU button in mode.**
The [Rec.Mode] menu appears.
- 2 Use the four-way controller (▲▼) to select [Memory].**
- 3 Press the four-way controller (▶).**
The Memory screen appears.
- 4 Use the four-way controller (▲▼) to choose an item.**
- 5 Use the four-way controller (◀▶) to select (On) or (Off).**
- 6 Press the OK button.**
The Memory setting is saved.
- 7 Press the MENU button.**
The camera returns to capture status with the current setting.

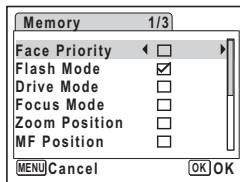

Recording Movies

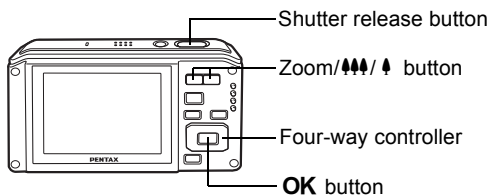

4

Recording a Movie

This mode enables you to record movies. Sound is recorded at the same time.

1 Press the four-way controller (▼) in mode.

The Capture Mode Palette appears.

2 Use the four-way controller (▲▼◀▶) to select (Movie).



3 Press the OK button.

(Movie) mode is selected and the camera returns to capture status.

The following information appears on the display.

- 1 Movie mode icon
- 2 Recording indicator (blinks during recording)
- 3 Remaining recordable time
- 4 Focus frame (does not appear during recording)
- 5 Still picture and capture icon (shown during recording)
- 6 Movie shake reduction function icon

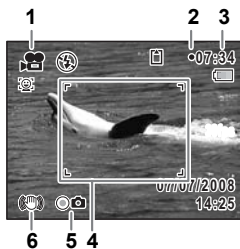

You can change the captured area by pressing the Zoom/AAA/▲ button.

▲ : enlarges the subject

AAA : widens the area that is captured by the camera

4 Press the shutter release button fully.

Recording starts. Recording can continue until the built-in memory/SD Memory Card is full or the size of the recorded movie reaches 2 GB.



- The flash does not discharge in mode.
- The focus mode can be changed before recording starts.
- When the Focus Mode is set to **AF**, , or , pictures are taken by pressing the shutter release button half-way down to lock the focus before shooting. However from the menu settings, you can select to continue adjusting the focus after focusing on a subject while recording movies (p.140).
- When the Focus Mode is set to **MF** (Manual Focus), you can adjust the focus before recording starts.
- Optical and digital zoom can be used before recording starts. These can also be used during recording, depending on the shooting menu settings.
- You cannot change what is shown on the display by pressing the **OK/DISPLAY** button while recording a movie.
- When the shooting mode is set to , Face Priority is automatically set to on. You can select Smile Capture or Face Priority Off by pressing the button before starting recording a movie. (p.59) When Smile Capture is activated, movie recording starts automatically when the camera recognizes the subject's smile. However, depending on the condition of the recognized faces, movie recording may not start automatically because the Smile Capture function will not work. If this happens, press the shutter release button to start movie recording.

5 Press the shutter release button fully.

Recording stops.

Playing Back Movies p.153

Keeping the Shutter Release Button Pressed

If you keep the shutter release button pressed for more than one second, recording will continue as long as you keep the button pressed. Shooting stops when you take your finger off the shutter release button.

Taking Still Pictures during Movie Recording (Still picture capture)

Press the Green button during movie recording to take still pictures while continuing to record the movie. After the Green button is pressed, a still picture is taken and stored.



When the battery level indicator is at  (battery is exhausted), the flash will not discharge when taking still pictures during movie recording.

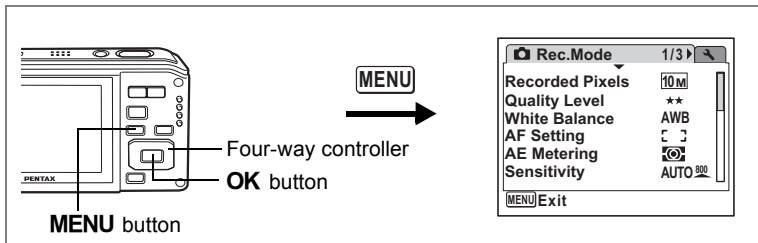

Selecting the Recorded Pixels and Frame Rate for Movies

Set the recorded pixels and frame rate for movies.

The more pixels there are, the clearer the details and the bigger the file size.

The more frames per second, the better the quality of the movie, but the file size increases.

Select from [**1280**] (1280×720) 15fps*, [**640**] (640×480) 30fps], [**640**] (640×480) 15fps], [**320**] (320×240) 30fps], or [**320**] (320×240) 15fps].

Recorded Pixels for Movies

[1280] (1280×720) : 15fps	↑ HD movies with a horizontal aspect ratio of 16:9 (*). For watching on a TV and other AV equipment. ↓ For posting on websites or attaching to e-mails.
[640] (640×480) : 30fps	
[640] (640×480) : 15fps	
[320] (320×240) : 30fps	
[320] (320×240) : 15fps	

* Playback requires a computer.

- 1 Press the MENU button in mode.**
The [Rec.Mode] menu appears.
- 2 Use the four-way controller (▲ ▼) to select [Movie].**
- 3 Press the four-way controller (▶).**
The Movie screen appears.

4 Use the four-way controller (▲▼) to select [Recorded Pixels].

5 Press the four-way controller (▶).

A pull-down menu appears.

6 Use the four-way controller (▲▼) to change the number of recorded pixels.

7 Press the OK button.

The Recorded Pixels setting is saved.

8 Press the MENU button twice.

The camera returns to capture status with the current setting.

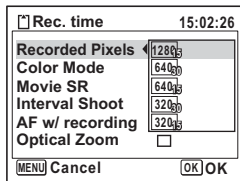

Recorded Pixels for Movies/Frame Rate \approx p.35

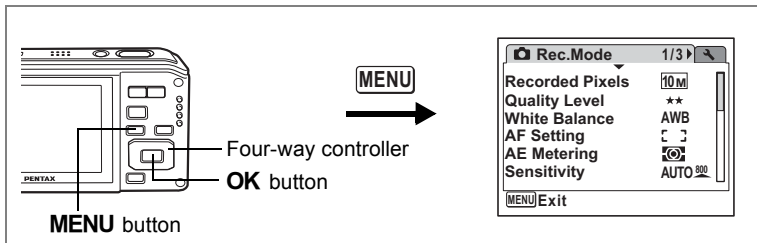

Recording Movies in Black and White or Sepia Tones (Color Mode)

In Movie mode, you can set the color mode to [B&W] or [Sepia], as well as [Full Color].

- 1 Press the MENU button in mode.**
The [Rec.Mode] menu appears.
- 2 Use the four-way controller (▲▼) to select [Movie].**
- 3 Press the four-way controller (▶).**
The Movie screen appears.
- 4 Use the four-way controller (▲▼) to select [Color Mode].**
- 5 Press the four-way controller (▶).**
A pull-down menu appears.
- 6 Use the four-way controller (▲▼) to choose a color.**
- 7 Press the OK button.**
The Color Mode setting is saved.
- 8 Press the MENU button twice.**
The camera returns to capture status with the current setting.

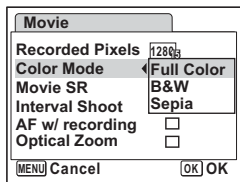

The color mode setting for a recorded movie cannot be changed.

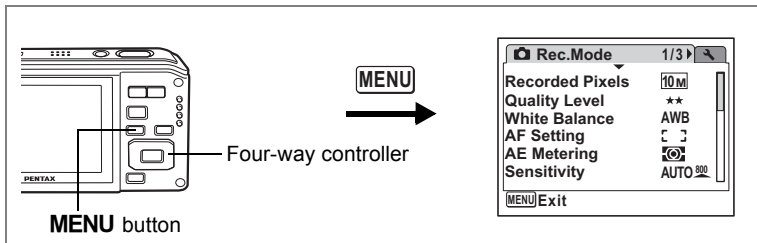

Setting the Movie SR (Movie Shake Reduction) Function

4

While recording a movie, you can compensate for camera movement with the Movie SR (Movie Shake Reduction) function.

- 1 **Press the MENU button in mode.**
The [Rec.Mode] menu appears.
- 2 **Use the four-way controller (▲▼) to select [Movie].**
- 3 **Press the four-way controller (▶).**
The Movie screen appears.
- 4 **Use the four-way controller (▲▼) to select [Movie SR].**
- 5 **Use the four-way controller (◀▶) to select (On) or (Off).**
The Movie SR (Movie Shake Reduction) setting is saved.
- 6 **Press the MENU button twice.**
The camera returns to capture status with the current setting.

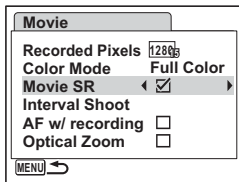

Setting Movie SR to (On) makes the captured area smaller than with (Off).

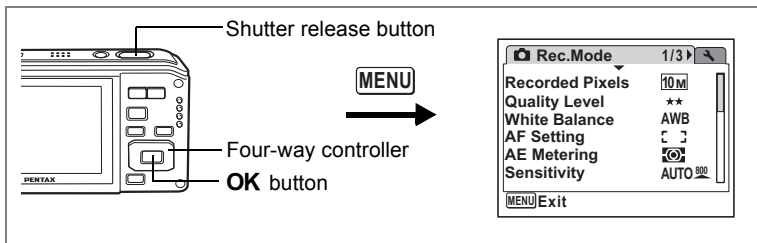

Recording a Movie from Pictures Taken at a Set Interval (Interval Movie)

In this mode, you can record multiple still pictures taken automatically at a set interval from a set time, as a movie file.

Interval	You can set this to 1 minute, 5 minutes, 10 minutes, 30 minutes, or 1 hour.
Total Time	Set the total time, from 10 minutes to 359 hours. The total time and the settable units change depending on the interval set. The Interval can be set in increments of 1 minute, 5 minutes, 10 minutes, 30 minutes, or 1 hour.
Start Delay	Set the start delay, from 0 minutes to 24 hours. The start delay can be set in increments of 1 minute for a delay time up to 59 minutes, and increments of 1 hour for a delay time longer than one hour. If the start delay is set to 0 min., the first picture is taken as soon as the shutter release button is pressed.

1 Press the four-way controller (▲) in or mode.

2 Use the four-way controller (◀▶) to select (Interval Shoot) and press the OK button.

The current Interval Movie setting appears for approximately one minute. To take pictures with the current setting, go to Step 10.



3 Press the OK button while the setting is displayed.

The Interval Movie setting screen appears. [Interval] is marked with the frame.

4 Set the interval.

- 1 Press the four-way controller (▶).
- 2 Use the four-way controller (▲▼) to set the interval, then press the OK button.

The frame returns to [Interval].

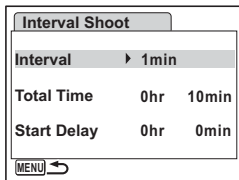

5 Press the four-way controller (▼).

The frame moves to [Total Time].

6 Set the total time.

- 1 Press the four-way controller (▶).
- 2 Use the four-way controller (▲▼) to set the hour, then press the four-way controller (▶).
- 3 Use the four-way controller (▲▼) to set the minute, then press the four-way controller (▶).

The frame returns to [Total Time].

7 Press the four-way controller (▼).

The frame moves to [Start Delay].

8 Set the start delay.

- 1 Press the four-way controller (▶).
- 2 Use the four-way controller (▲▼) to set the hour, then press the four-way controller (▶).
- 3 Use the four-way controller (▲▼) to set the minute, then press the four-way controller (▶).

The frame returns to [Start Delay].

9 Press the MENU button.

The Interval movie setting is saved and the camera returns to capture status.

10 Press the shutter release button halfway.

The focus frame on the display turns green if the subject is in focus.

11 Press the shutter release button fully.

Interval movie recording starts.

The camera turns off between shots (during standby). Press the power switch during standby to display the remaining number of shots and interval on the display.

The [Stop interval shooting?] message is displayed when the power switch and then the **MENU** button are pressed during standby. Pressing the **OK** button cancels interval shooting.



- Confirm that the battery is sufficiently charged before starting interval movie recording. If the battery is not sufficiently charged, it may become depleted during interval movie recording and cause recording of the movie to stop.
- When performing interval movie shooting, the settings are fixed as follows; Recorded Pixels: **640**, Quality Level **★★★**, Movie SR: (Off), and Flash Mode: **Ⓢ**.



- If you set a start delay, a start time corresponding to the current time and the start delay you set is displayed in real time.
- The total time you can set differs according to the shooting interval you set, as indicated in the table below.

Interval	Total time that can be set	
	30fps	15fps
1 min	10 minutes to 5 hours and 59 minutes (in increments of 1 minute)	10 minutes to 5 hours and 59 minutes (in increments of 1 minute)
5 min	30 minutes to 29 hours and 55 minutes (in increments of 5 minutes)	15 minutes to 29 hours and 55 minutes (in increments of 5 minutes)
10 min	1 hour to 59 hours and 50 minutes (in increments of 10 minutes)	30 minutes to 59 hours and 50 minutes (in increments of 10 minutes)
30 min	3 hours to 179 hours and 30 minutes (in increments of 30 minutes)	1 hour and 30 minutes to 179 hours and 30 minutes (in increments of 30 minutes)
1 hr	6 hours to 359 hours (in increments of 1 hour)	3 hours to 359 hours (in increments of 1 hour)

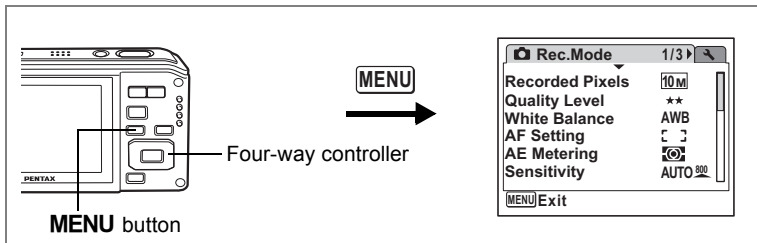

Selecting the Focusing Method for Recording Movies

You can set the focusing method used when recording movies. Select either to always continue to focus on the subject while shooting, or to lock the focus in the position selected by pressing the shutter release button halfway with the subject in focus before shooting.

- 1** Press the **MENU** button in **📷** mode.
- 2** Use the four-way controller (**▲ ▼**) to select **[Movie]**.
- 3** Press the four-way controller (**▶**).
The Movie screen appears.
- 4** Use the four-way controller (**▲ ▼**) to select **[AF w/recording]**.
- 5** Use the four-way controller (**◀ ▶**) to select (**On**) or (**Off**).

- (**On**): Always focuses on the subject while recording.
- (**Off**): Locks the focus in the position selected by pressing the shutter release button halfway with the subject in focus before recording.

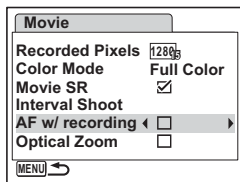

- 6** Press the **MENU** button twice.

The camera returns to capture status with the current setting.



Depending on the shooting environment, the noise from focusing is recorded when a focus mode other than **PF** or **▲** is selected and **[AF w/ recording]** is set to (**On**).

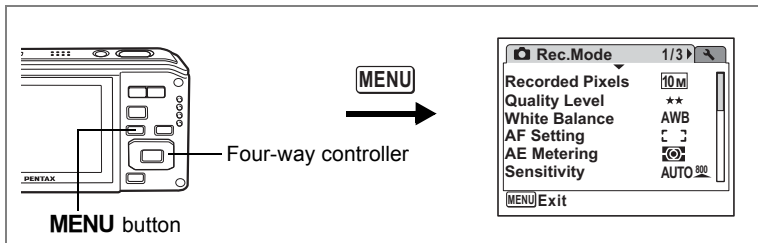

Setting the Optical Zoom

You can set whether or not to use the optical zoom during movie recording.

- 1 Press the MENU button in mode.**
The [Rec.Mode] menu appears.
- 2 Use the four-way controller (▲▼) to select [Movie].**
- 3 Press the four-way controller (▶).**
The Movie screen appears.
- 4 Use the four-way controller (▲▼) to select [Optical Zoom].**
- 5 Use the four-way controller (◀▶) to select (On) or (Off).**
The Optical Zoom setting is saved.
- 6 Press the MENU button twice.**
The camera returns to capture status with the current setting.

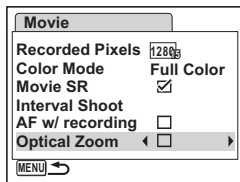



The noise from lens operation is recorded when [Optical Zoom] is set to (On).



Playing Back Images

Switching Between Mode and Mode

To Switch from  Mode to  Mode



- 1 **Press the  button.**
The camera switches to  mode.

To Switch from  Mode to  Mode

- 1 **Press the  button or shutter release button halfway.**
The camera switches to  mode.

Displaying data in the built-in memory

When an SD Memory Card is inserted in the camera, images, movies, and sounds on the SD Memory Card are displayed. If you want to display images, movies, and sounds in the built-in memory, remove the SD Memory Card.

- **[Viewing images in the built-in memory while the SD Memory Card is inserted (built-in memory display)]**
 - When switching from  mode to  mode, you can display images, movies, and sounds in the built-in memory while the SD Memory Card is inserted by pressing the  button for more than one second.
 - In built-in memory display, you can play back still pictures (including enlarged display) (p.45, p.145), movies (p.153), and sounds (p.187), and switch between nine-image display, folder display, and calendar display (p.144).
 - In built-in memory display, you cannot delete data, delete a selection, display the Playback Mode Palette, or display the menu. If you want to perform any of these operations on images, movies, or sounds in the built-in memory, do so after removing the SD Memory Card.

Playing Back Still Pictures

Refer to “Playing Back Images” (p.45) for instructions.

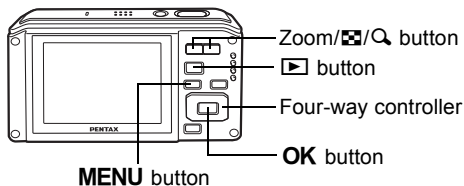

Nine-Image Display, Folder Display and Calendar Display

Nine-Image Display

You can display nine thumbnails of captured images at a time.

1 Press the Zoom//Q button towards in mode.

A page consisting of nine thumbnail images appears. The displayed images change nine at a time page by page.

Use the four-way controller (><><) to move the frame. When 10 or more images have been saved, if you choose image ① and press the four-way controller (><), the previous page appears. Similarly, if you choose image ② and press the four-way controller (><), the next page appears.

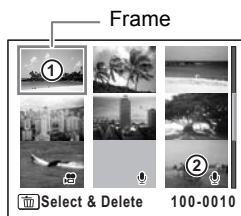

The icons that appear on the images indicate the following:

- No icon : Still picture without sound
- : Still picture that can have camera shake corrected
- (with image) : Still picture with sound
- : Movie (the first frame appears)
- (without image) : Sound file only

To switch to single image display, press the Zoom//Q button towards , or the **OK** button or the **MENU** button.

Press the button to switch to mode.

Switching to Calendar Display or Folder Display

Press the Zoom//Q button towards in nine-image display to switch to calendar or folder display (the default is calendar display). Press the Green button to switch between calendar display and folder display.

1 Press the Zoom//Q button towards in mode.

The screen changes to nine-image display.

2 Press the Zoom//Q button towards .

The screen changes to calendar display or folder display.

Calendar display

Recorded images and sound files are displayed by date in calendar format.

The first image recorded on a date is displayed for that date on the calendar.

appears for dates on which a sound file was the first recorded file.

Use the four-way controller () to move the frame.

If you select a date and press the Zoom//Q button towards , images taken on that date are displayed in nine-image display.

Select a date and press the **OK** button to switch to single-image display of the first image recorded on that date.

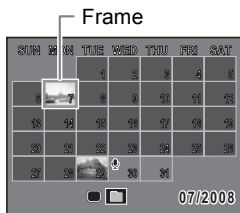

Folder display

The list of folders with recorded images and sound files appears.

Use the four-way controller () to move the frame.

If you select a folder and press the Zoom//Q button towards or the **OK** button, images in the folder are displayed in nine-image display.

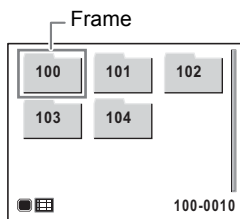

- Press the **MENU** button in folder display or calendar display to switch to normal nine-image display.
- Press the button or half-press the shutter release button in folder display or calendar display to switch to mode.

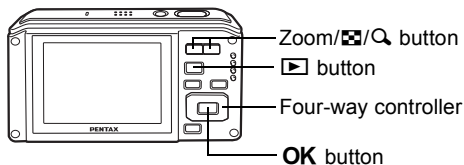

Zoom Playback

You can magnify an image up to ten times. A guide showing the center of the magnified portion of the image appears on the display during zoom playback.

- 1 Enter the mode and use the four-way controller () to choose the image you want to magnify.
- 2 Press the Zoom//Quick button towards .

The image is magnified (1.1× to 10×). Holding down the Zoom//Quick button towards continuously magnifies the image.

With Quick Zoom (p.206) set to (On), pressing once magnifies the image to 10×.

You can use the guide at the bottom left of the screen to check which portion of the image is magnified.



Guide

The following operations can be performed while the magnified image is displayed.

- | | |
|---------------------------|-------------------------------------|
| Four-way controller () | Moves the position to be magnified |
| Zoom//Quick button () | Makes the image bigger (max. 10×) |
| Zoom//Quick button () | Makes the image smaller (min. 1.1×) |

- 3 Press the OK button.

The image returns to single-image display.



Movies cannot be magnified.

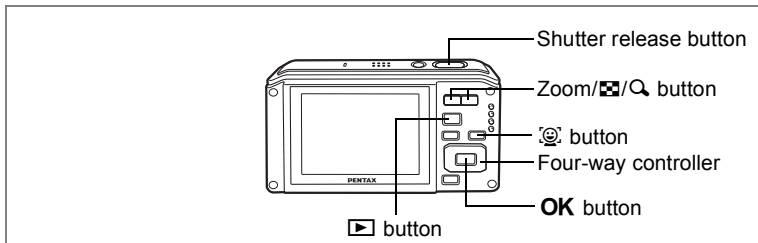

Zoom Up on the Subject's Face Automatically (Face close-up playback)

You can enjoy playing back images with the subject's faces zoomed up simply by pressing the [Smiley Face] button (Face close-up playback) if Face Recognition was used when the images were taken.

- 1 Enter the [Play] mode and use the four-way controller (◀▶) to choose the image you want to magnify.**
- 2 Confirm that the [Smiley Face] icon is displayed in the image and press the [Smiley Face] button.**

Face close-up plays back centering first on the face that had the main face frame displayed on it during shooting.



If multiple faces were recognized when the image was taken, the subject's faces are zoomed up on each time the [Smiley Face] button is pressed in order of the recognition during shooting.

Pressing the [Smiley Face] button, after Face Close-up Playback of all recognized faces, returns to the normal playback display.



- 3 Press the OK button.**

The image returns to single-image display.



- The magnification ratio for Face close-up playback may differ depending the conditions such as the size of the face recognized when shooting.
- Press the Zoom//Q button towards Q during Face close-up playback to center on the subject and switch between displaying the image at an equal or slightly larger magnification. Also, press the Zoom//Q button towards to center on the subject and switch between displaying the image at an equal or slightly smaller magnification.
- Face close-up playback is unavailable for movies, images saved from movies, and images taken in Digital SR with shake reduction.

Displaying Shooting Information in Playback Mode

Shooting information can be displayed on the display in  mode. Pressing the **OK/DISPLAY** button changes the display mode. Refer to p.23 for details of each display mode.

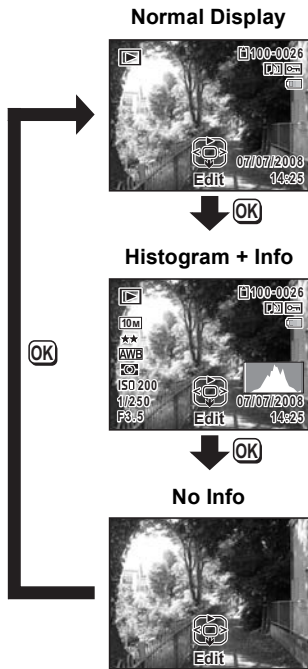

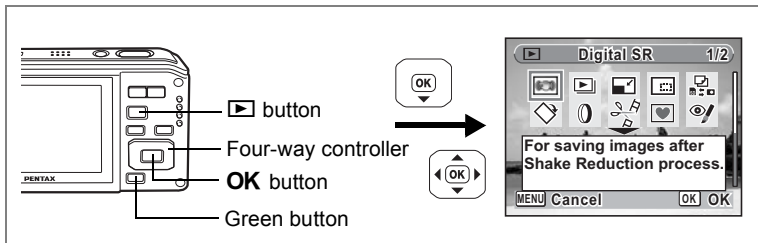

Displaying Shooting Information in Capture Mode  p.98



Correcting Camera Shake with Digital SR

For correcting the camera shake in recorded images.

- 1 Enter the  mode and use the four-way controller (◀▶) to choose the image to correct camera shake for.
- 2 Press the four-way controller (▼).
The Playback Mode Palette appears.
- 3 Use the four-way controller (▲▼◀▶) to select  (Digital SR).
- 4 Press the OK button.
The image to correct is displayed.
- 5 Press the OK button.
When an image is protected, the image is automatically saved as a new image without displaying the confirmation dialog on the screen.
- 6 Use the four-way controller (▲▼) to select [Overwrite] or [Save as].
- 7 Press the OK button.
The corrected image is saved in the built-in memory or SD Memory Card.







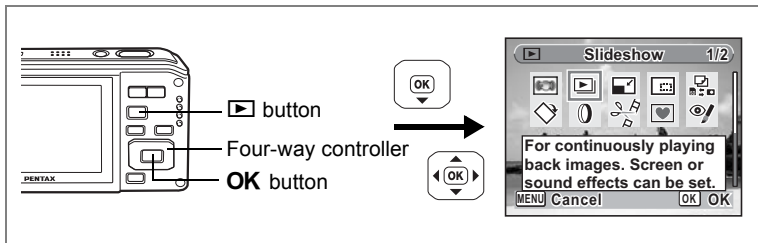





- If you overwrite the image, the shake information is lost and you cannot perform shake correction again.
-  appears on the upper left of the display only when playing back images for which camera shake can be corrected. However, camera shake may not be corrected when the camera shake is too extreme. In such cases, the error message will appear in step 5.
- Digital SR processing is unavailable for images taken with Movie, Frame Composite mode or Digital Wide mode. It is also unavailable with images processed using Resize, Cropping, Digital Filter, or Frame Composite from the Playback Mode Palette.









Slideshow

You can play back recorded images one after another.

- 1 Enter the  mode and use the four-way controller ( ) to choose an image to start the slideshow with.**
- 2 Press the four-way controller (.**
The Playback Mode Palette appears.
- 3 Use the four-way controller (   ) to select  (Slideshow).**
- 4 Press the OK button twice.**
The slideshow starts.
Pressing the **OK** button during the slideshow pauses the slideshow. To resume the slideshow, press the **OK** button while the slideshow is paused.
- 5 Press any button other than the OK button.**
The slideshow stops.

Setting the Slideshow Conditions

You can set the playback interval and also a screen effect and sound effect for when one image changes to the next.

- 1 Press the four-way controller ( in  mode.**
The Playback Mode Palette appears.
- 2 Use the four-way controller (   ) to select  (Slideshow).**

3 Press the OK button.

The screen for setting the slideshow conditions appears.

4 Use the four-way controller (▲▼) to select [Interval].**5 Press the four-way controller (▶).**

A pull-down menu appears.

6 Use the four-way controller (▲▼) to change the interval and press the OK button.

You can choose from 3sec, 5sec, 10sec, 20sec, and 30sec.

7 Use the four-way controller (▲▼) to select [Screen Effect].

After selecting [Screen Effect], press the four-way controller (▶). A pull-down menu appears with the following items that can be selected. Use the four-way controller (▲▼) to select an item and press the **OK** button.

Wipe	The next image slides over the previous one from left to right
Checker	The next image appears in small square mosaic blocks
Fade	The current image gradually fades out and the next image fades in
Off	No effect

8 Use the four-way controller (▲▼) to select [Sound Effect].**9 Use the four-way controller (◀▶) to select (On) or (Off).**

Except when the screen effect is set to Off, you can choose (On) or (Off) for the sound that is played when one image changes to the next.

10 Press the OK button.

The slideshow starts using the selected interval and effect.



- The slideshow will continue until you press any button other than the **OK** button.
- Movies or pictures with sound will normally be played through to the end before the next picture is played back, regardless of the interval setting. However, pressing the four-way controller (▶) while playing back a movie or a picture with sound skips to the next image.
- Sound files made in (Voice Recording) mode are not played back in the slideshow.
- Panorama images will be scrolled for display from left to right in 4 seconds before the next picture is played back, regardless of the settings of [Interval] or [Screen Effect].

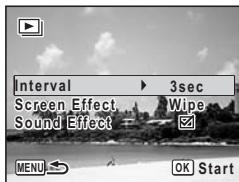

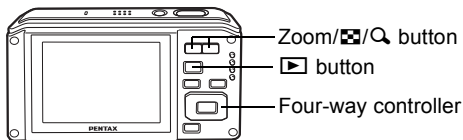

Playing Back Movies



Playing Back a Movie

You can play back the movies you have taken. Sound is played back at the same time.





1 Enter the  mode and use the four-way controller ( ) to choose the movie you want to play back.

2 Press the four-way controller ().



Playback starts.



The following operations can be performed during playback.

- Four-way controller () Plays back in reverse
- Four-way controller () Pauses playback
- Zoom/Matrix/Quick button () Increases the volume
- Zoom/Matrix/Quick button () Reduces the volume

The following operations can be performed while playback is paused.

- Four-way controller () Reverses the frame
- Four-way controller () Forwards the frame
- Four-way controller () Releases the Pause function (Play)

3 Press the four-way controller ().

Playback stops.

Connecting the Camera to AV Equipment

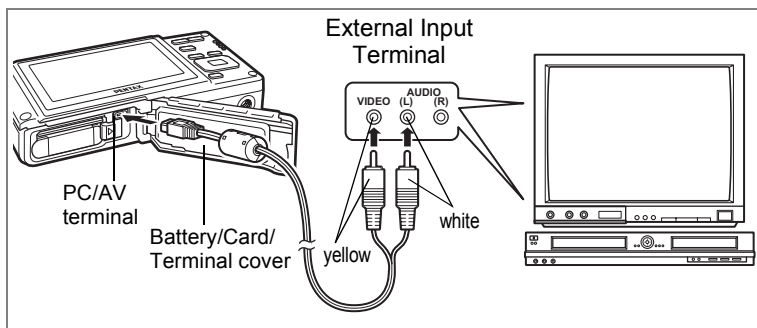

By using the AV cable, you can capture and play back images on equipment with a video IN jack, such as a TV. Make sure the camera and TV are turned off before connecting the camera to the TV.

5

Playing Back and Deleting Images

- 1 Open the battery/card/terminal cover and connect the AV cable to the PC/AV terminal.**
- 2 Connect the other ends of the AV cable (yellow: video, white: audio) to the video input terminal and audio input terminal of the AV device.**

Connect the terminal of the AV cable with pointing toward the ◀ on the PC/AV terminal of the camera.

- 3 Turn the AV device on.**

When the device that the camera is connected to and the device that plays back images are different, turn both devices on.

When viewing images on AV equipment with multiple video input terminals (such as a TV), refer to the operation manual of the device and select the video input terminal to which the camera is connected.



Caution High-definition movies cannot be directly played back on AV equipment such as TVs. They can be played back by transferring them to a computer.

4 Turn the camera on.



- You are recommended to use the AC adapter kit K-AC78 (optional) if you intend to use the camera for a long time.
- Depending on the country or region, images and sound files may fail to be played back if the video output format is set different from the one in use there. If this happens, change the video output format setting. (p.202)
- The camera display turns off while the camera is connected to AV equipment.
- Volume cannot be adjusted with the zoom button while the camera is connected to AV equipment.

Deleting Images

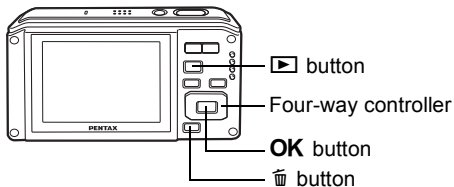

Delete images and sounds with mistakes or that are unnecessary.

When images or sounds are inadvertently deleted





Deleted images and sounds can be recovered with the Optio W60. (p.161)
Deleted images and sounds can be recovered even if the camera has been turned off after deletion as long as the SD Memory Card has not been removed. However, deleted images and sounds cannot be recovered after formatting or performing data write operations such as taking pictures, recording movies, protecting images, saving DPOF settings, resizing images, or cropping images.

Deleting a Single Image/Sound File

You can delete a single image or sound file.



Protected images and sound files cannot be deleted. (p.162)

- 1 Enter the  mode and use the four-way controller () to choose the image/sound file you want to delete.**
- 2 Press the .**
A confirmation screen appears.
- 3 Use the four-way controller () to select [Delete].**
- 4 Press the OK button.**
The image or sound file is deleted.



If you press the  button during Instant Review, the screen in Step 2 appears, enabling you to delete the image you have just taken. (p.46)

Recovering Deleted Images  p.161

Deleting a Sound File

If sound has been recorded with an image (p.188), you can delete the sound without deleting the image.

1 Enter the  mode and use the four-way controller (◀▶) to choose an image with sound.

2 Press the  button.

A confirmation screen appears.

3 Use the four-way controller (▲▼) to select [Delete Sound].

4 Press the OK button.

The sound file is deleted.



Select [Delete] in Step 3 above to delete both the image and sound file.

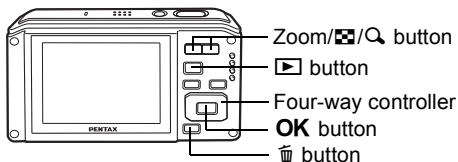

Deleting Selected Images and Sound Files (from Nine-Image Display)

You can delete several images/sound files selected from the nine-image display at once.



Protected images and sound files cannot be deleted.

5

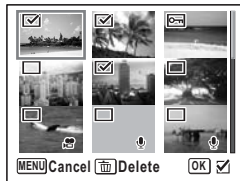

- 1 **Press the Zoom//Quick button towards in mode.**
Nine thumbnail images appear.
- 2 **Press the button.**
 appears on the images and sound files.
- 3 **Use the four-way controller () to choose the images and sound files that you want to delete and press the OK button.**
 appears on the selected images and sound files.



The selected image is shown in single-image display only while pressing the Zoom//Quick button towards so you can check whether to delete the image. (The display returns to the nine-image display when you release the button.) However, protected images cannot be displayed in single-image display.

4 Press the  button.

A confirmation dialog appears.

5 Use the four-way controller ( ) to select [Select & Delete].

6 Press the OK button.

The selected images and sound files are deleted.



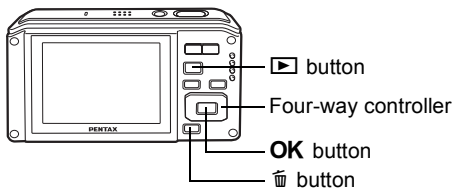

Deleting All Images and Sound Files

You can delete all the images and sound files at once.



Protected images and sound files cannot be deleted. (p.162)

5

- 1 **Press the 🗑️ button in ▶ mode.**
A confirmation dialog appears.
- 2 **Press the 🗑️ button.**
A confirmation dialog appears.
- 3 **Use the four-way controller (▲▼) to select [Delete All].**
- 4 **Press the OK button.**
All the images and sound files are deleted.

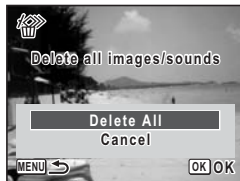

Recovering Deleted Images ↻ p.161

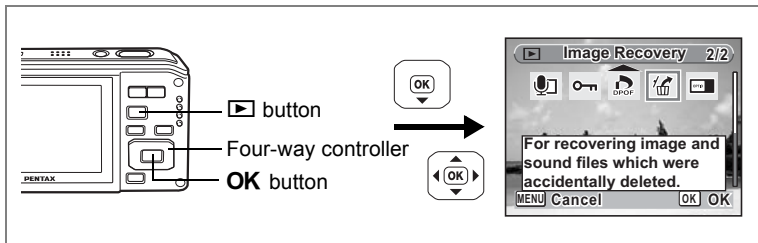

Recovering Deleted Images

You can recover images or sound files that were taken with this camera and then deleted.



After deleting an image, if formatting or operations to write data such as taking pictures, recording movies, protecting images, saving DPOF settings, resizing images, or cropping images have been performed, or if the SD Memory Card has been removed, the message “No image to be processed” appears in Step 3 and the deleted images and sound files cannot be recovered.

- 1 After deleting a file, press the four-way controller (▼).**
The Playback Mode Palette appears.
- 2 Use the four-way controller (▲▼◀▶) to select .**
(Image Recovery).
- 3 Press the OK button.**
The number of recoverable images appears.
- 4 Use the four-way controller (▲▼) to select [Recover].**
- 5 Press the OK button.**



Deletion of the images is cancelled and the files are recovered.



- Recovered images and sound files have the same file name as before they were deleted.
- Up to a maximum of 999 deleted image files can be recovered.

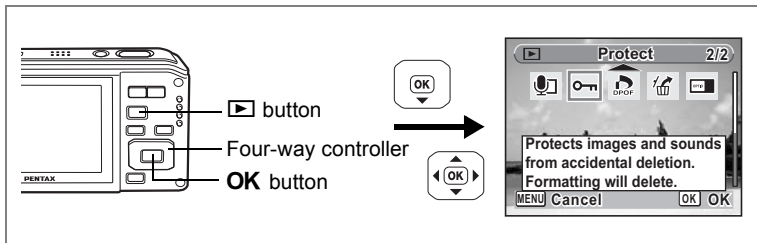

Protecting Images and Sound Files from Deletion (Protect)

You can protect stored images and sound files from being accidentally deleted.

- 1 Press the four-way controller (▼) in ▶ mode.**
The Playback Mode Palette appears.
- 2 Use the four-way controller (▲▼◀▶) to select (Protect).**
- 3 Press the OK button.**
The screen for selecting [Single Image/Sound] or [All Images/Sounds] appears.
- 4 Use the four-way controller (▲▼) to select [Single Image/Sound].**
- 5 Press the OK button.**
The message [Protect this image/sound] appears.
To protect another image or sound file, use the four-way controller (◀▶) to select another image or sound file.
- 6 Use the four-way controller (▲▼) to select [Protect].**
- 7 Press the OK button.**
The selected image or sound file is protected.



- To cancel the Protect setting, select [Unprotect] in Step 6.
- appears below the file number on protected images and sound files during playback.
- You can protect another image or sound file by further performing the above 5, 6, and 7 Steps. However, the maximum number you can protect in succession by the above Steps cannot exceed 99.

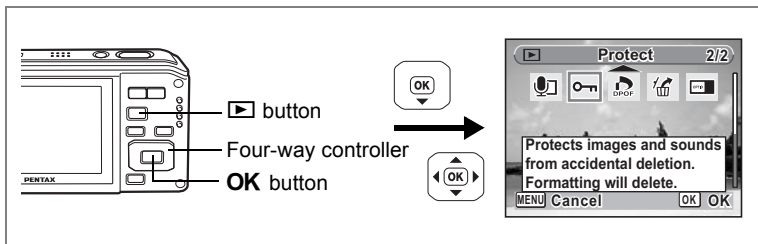

Protecting All Images and Sound Files

- 1 Press the four-way controller (▼) in [▶] mode.**
The Playback Mode Palette appears.
- 2 Use the four-way controller (▲▼◀▶) to select [Protect].**
- 3 Press the OK button.**
The screen for selecting [Single Image/Sound] or [All Images/Sounds] appears.
- 4 Use the four-way controller (▲▼) to select [All Images/Sounds].**
- 5 Press the OK button.**
The screen for selecting [Protect] or [Unprotect] appears.
- 6 Use the four-way controller (▲▼) to select [Protect].**
- 7 Press the OK button.**
All the images and sound files are protected.



Protected images and sound files will be deleted when the SD Memory Card is formatted.



To cancel the Protect setting on all your images and sound files, select [Unprotect] in Step 6.

Editing Images

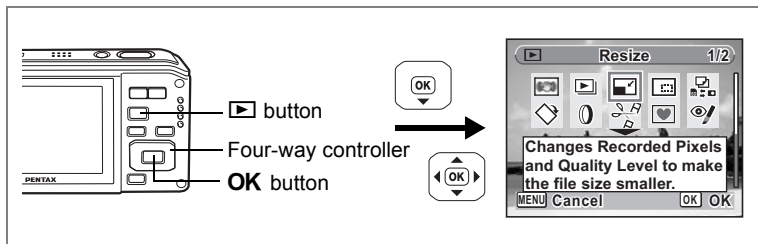

Changing the Image Size and Quality (Resize)

By changing the size and quality of a selected image, you can make the file size smaller than the original. You can use this function to continue taking pictures when the SD Memory Card or built-in memory is full, by making the images smaller and overwriting the original images to make more space available.



- Movies cannot be resized.
- You cannot select a larger resolution or higher quality than that of the original image.

6

- 1 Enter the mode and use the four-way controller () to choose the image you want to resize.**
- 2 Press the four-way controller ().**
The Playback Mode Palette appears.
- 3 Use the four-way controller () to select (Resize).**
- 4 Press the OK button.**
The screen for choosing the size and quality appears.
- 5 Select [Recorded Pixels] and [Quality Level].**

Use the four-way controller () to choose the size and quality.

Use the four-way controller () to switch between [Recorded Pixels] and [Quality Level].



6 Press the OK button.

A confirmation dialog for overwriting the image appears.

When an image is protected, the image is automatically saved as a new image without displaying the confirmation dialog on the screen.

7 Use the four-way controller (▲▼) to select [Overwrite] or [Save as].

8 Press the OK button.

The resized image is saved.



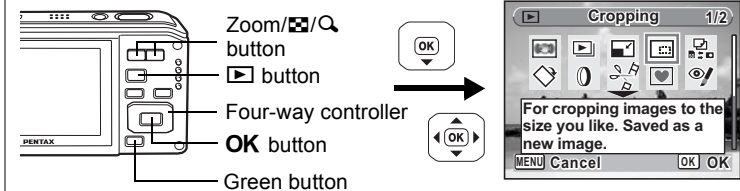

Cropping Images

You can delete the unwanted part of a picture and save the cropped image as a separate image.

- 1 Enter the mode and use the four-way controller () to choose the image you want to trim.**
- 2 Press the four-way controller ().**
The Playback Mode Palette appears.
- 3 Use the four-way controller () to select (Cropping).**
- 4 Press the OK button.**

The cropping screen appears.

The maximum range for cropping is shown with a green frame on the screen. Cropping cannot be performed inside of this area.

- 5 Choose the cropping conditions.**

The following operations move the green frame and set the area for cropping on the screen.

Zoom//Quality button

Changes the size of the cropped section

Four-way controller ()

Moves the cropping position up, down, left and right

Green button

Rotates the cropping frame

- 6 Press the OK button.**

The cropped image is saved with a new file name.

The cropped image is saved in the same quality as the original image. The number of recorded pixels is selected automatically according to the size of the cropped section.



Movies cannot be cropped.

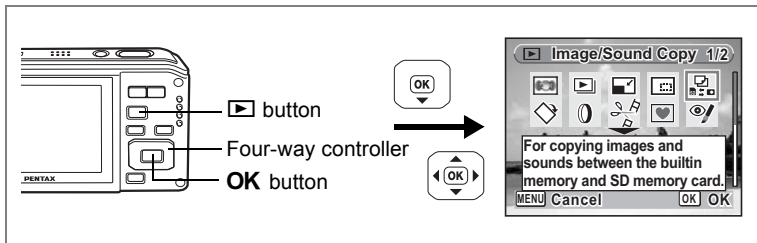

Copying Images and Sound Files

You can copy images and sound files from the built-in memory to the SD Memory Card and vice versa. This function can only be selected when an SD Memory Card has been inserted in the camera.



Make sure that the camera is turned off before inserting or removing the SD Memory Card.

- 1 Press the four-way controller (▼) in ▶ mode.**
The Playback Mode Palette appears.
- 2 Use the four-way controller (▲▼◀▶) to select .**
(Image/Sound Copy).
- 3 Press the OK button.**
The copying method selection screen appears.

To Copy Files from the Built-in Memory to the SD Memory Card

All the images and sound files in the built-in memory are copied to the SD Memory Card at once. Before copying the images, make sure that there is enough space on the SD Memory Card.

- 4 Use the four-way controller (▲▼) to select [ → SD].**
- 5 Press the OK button.**
All the images and sound files are copied.



To Copy Files from the SD Memory Card to the Built-in Memory

Selected images and sound files from the SD Memory Card are copied to the built-in memory one at a time.

- 4 Use the four-way controller (▲▼) to select [SD] → [●].
- 5 Press the OK button.
- 6 Use the four-way controller (◀▶) to select the file you want to copy.
- 7 Press the OK button.



The selected image/sound file is copied.



- If sound has been recorded with the image, the sound file is copied with the image.
- When a file is copied from the SD Memory Card to the built-in memory, it is assigned a new file name.

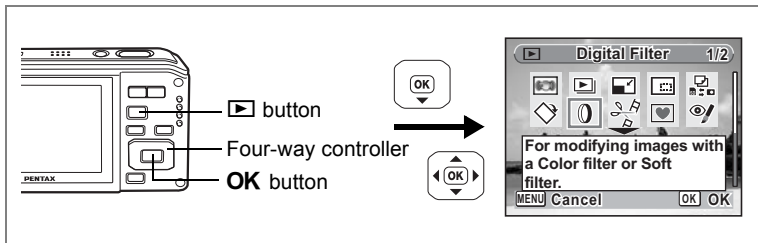

Using the Digital Filters

This mode lets you change the color tones and perform special processing on a selected image.

Digital Filters

B&W filter	Processes the image using the B&W filter.
Sepia filter	Processes the image using the sepia filter.
Color filter	Processes the image using the selected color filter. You can choose from six filters: red, pink, purple, blue, green, and yellow.
Color extraction filter	Processes the image using the selected color extraction filter. You can choose from three filters: Red, Green, and Blue.
Soft filter	Processes the image into a soft image.
Brightness Filter	Adjusts the brightness of the image.
Fish-eye Filter	Applies a fish-eye lens effect to images.

- 1** Enter the mode and use the four-way controller () to choose the image you want to edit.
- 2** Press the four-way controller ().
The Playback Mode Palette appears.
- 3** Use the four-way controller () to select (Digital Filter).
- 4** Press the OK button.
The digital filter selection screen appears.

- 1 B&W filter
- 2 Sepia filter
- 3 Color filter
- 4 Color extraction filter
- 5 Soft filter
- 6 Fish-eye Filter
- 7 Brightness Filter

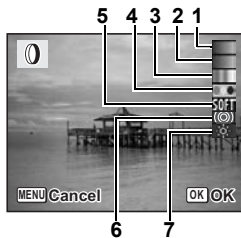

To Select a B&W/sepia filter or the Soft Filter

5 Use the four-way controller (▲▼) to choose a digital filter.

You can preview the results of the filter effect.

6 Press the OK button.

A confirmation dialog for overwriting the image appears. When an image is protected, the image is automatically saved as a new image without displaying the confirmation dialog on the screen.

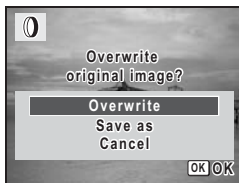

7 Use the four-way controller (▲▼) to select [Overwrite] or [Save as].

8 Press the OK button.

Images processed with a B&W/sepia filter or the soft filter are recorded with the same number of recorded pixels and quality level as the original image.

To Select a Color filter or the Color Extraction Filter

5 Use the four-way controller (▲▼) to choose a digital filter.

6 Use the four-way controller (◀▶) to adjust the effect.

The color filter changes in the following sequence each time you press the four-way controller (▶): Red, Pink, Purple, Blue, Green, and Yellow.

The color extraction filter changes in the following sequence each time you press the four-way controller (▶): Green, Blue, Red.

7 Press the OK button.

A confirmation dialog for overwriting the image appears. When an image is protected, the image is automatically saved as a new image without displaying the confirmation dialog on the screen.

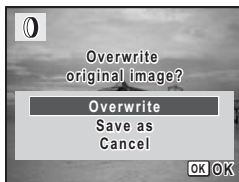

8 Use the four-way controller (▲▼) to select [Overwrite] or [Save as].

9 Press the **OK** button.

Images processed with a color filter or the color extraction filter are recorded with the same number of recorded pixels and quality level as the original image.

To Select the Brightness or Fish-eye Filter

5 Use the four-way controller (▲▼) to select the digital filter you want to use.

6 Use the four-way controller (◀▶) to adjust the effect.

For the brightness filter, the brightness increases each time you press the four-way controller (▶) and decreases each time you press the four-way controller (◀).

With the fish-eye filter, pressing the four-way controller to (▶) strengthens the effect and (◀) lessens the effect.



7 Press the **OK** button.

A confirmation dialog for overwriting the image appears.

When an image is protected, the image is automatically saved as a new image without displaying the confirmation dialog on the screen.

8 Use the four-way controller (▲▼) to select [Overwrite] or [Save as].

9 Press the **OK** button.

Images processed with the brightness or fish-eye filter are saved with the same number of recorded pixels and quality level as the original.



Movies or images taken with another camera cannot be edited using [Digital Filter]. An error message appears if you choose this function from the Playback Mode Palette and press the **OK** button.

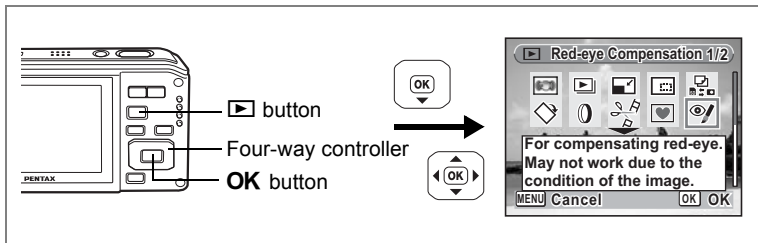

Red-eye Compensation

You can correct images where the flash has caused the subject to appear with red eyes.

- 1 Enter the mode and use the four-way controller () to choose the image you want to correct.**
- 2 Press the four-way controller ().**
The Playback Mode Palette appears.
- 3 Use the four-way controller () to select (Red-eye Compensation).**
- 4 Press the OK button.**

A confirmation dialog for overwriting the image appears. When an image is protected, the image is automatically saved as a new image without displaying the confirmation dialog on the screen.



- 5 Use the four-way controller () to select [Overwrite] or [Save as].**
- 6 Press the OK button.**

The edited image is saved with the same number of recorded pixels and quality level as the original.



- The red-eye compensation function cannot be used on movies or on images where red eyes cannot be detected on the camera. An error message appears in Step 4.
- The red-eye compensation function can only be used with still pictures taken with this camera.

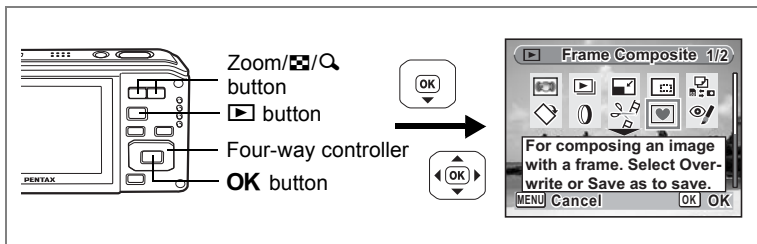

Adding a Frame (Frame Composite)

This function lets you add a decorative frame to still pictures.

- 1 Enter the mode and use the four-way controller (,) to choose the image to which you want to add a frame.
- 2 Press the four-way controller ().
The Playback Mode Palette appears.
- 3 Use the four-way controller (, , ,) to select (Frame Composite).
- 4 Press the OK button.
A 9-frame display of the frame selection screen appears.
- 5 Use the four-way controller (, , ,) to choose a frame.
- 6 Press the Zoom//Quick button towards .
The selected frame appears in single-image display.
You can choose another frame using either of the following operations.
 - Use the four-way controller (,) to choose a different frame.
 - Press the Zoom//Quick button towards to return to 9-frame display of the selection screen, and then perform Step 5 to choose a different frame.

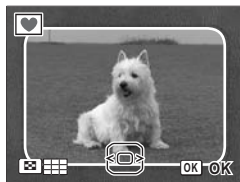
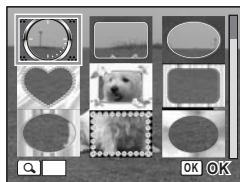

7 Press the OK button.

The frame position and size adjustment screen appears. Use the four-way controller (▲▼◀▶) to adjust the position of the image, and use the Zoom/☒/Q button to make the image larger or smaller.

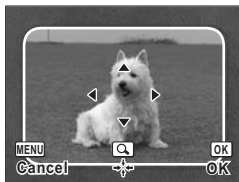

8 Press the OK button.

A confirmation dialog for overwriting the image appears. When an image is protected, the image is automatically saved as a new image without displaying the confirmation dialog on the screen.

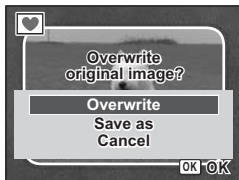

9 Use the four-way controller (▲▼) to select [Overwrite] or [Save as].

10 Press the OK button.

The edited image is saved with the recorded pixels of **3M**.



- The Frame Composite function cannot be used on movies or images taken in **7.5M** (16:9) or images smaller than **3M**. An error message appears in Step 4.
- 3 default frames and 77 optional frames are pre-installed at the factory. (the supplied CD-ROM provides over 80 frames, including the default frames.)

Using a New Frame

Frames downloaded from the PENTAX website can be used as frames for pictures. To display the frames available in the built-in memory or the SD Memory Card, in Step 3, select  (Frame Composite) and press the **OK** button.



- Extract the downloaded frame and copy it to the FRAME folder in the Built-in memory or SD Memory Card.
- The FRAME folder is created when the SD Memory Card is formatted with this camera.

Optional Frame Images





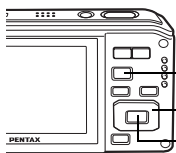



Optional frames are stored in the Optio W60 built-in memory using the image, movie, and sound recording areas. These optional frames may be deleted from built-in memory when file operations (delete, etc.) are performed from a computer. If these frames are deleted, recopy them from the supplied CD-ROM following the procedure on p.72.

How to display the Movie Edit menu



Editing Movies

You can select a frame from a recorded movie to save as a still picture or divide a movie into two.

- 1 Enter the  mode and use the four-way controller ( ) to choose the movie you want to edit.**
- 2 Press the four-way controller ().**
The Playback Mode Palette appears.
- 3 Use the four-way controller (   ) to select  (Movie Edit).**
- 4 Press the OK button.**

The movie edit selection screen appears.
Go to the following pages.

- Saving a Frame from a Movie as a Still Picture
- “Dividing a Movie” (p.176)



Protected movies cannot be divided.

Saving a Frame from a Movie as a Still Picture

- 5 Select [Save as Still image] on the movie edit selection screen.**

6 Press the OK button.

The screen appears for selecting a frame to be saved as a still picture.

7 Use the four-way controller (▲▼◀▶) to choose the frame you want to save.

- ▲ : Plays or pauses the movie
- ▼ : Stops the movie and returns to the first frame
- ◀ : Reverses the movie frame by frame
- ▶ : Advances the movie frame by frame

8 Press the OK button.

The selected frame is saved as a still picture.

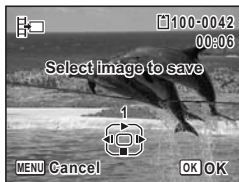

Dividing a Movie

5 Select [Divide Movies] on the movie edit selection screen.

6 Press the OK button.

The screen for choosing the dividing position appears.

7 Use the four-way controller (▲▼◀▶) to determine the dividing position.

- ▲ : Plays or pauses the movie
- ▼ : Stops the movie and returns to the first frame
- ◀ : Reverses the movie frame by frame
- ▶ : Advances the movie frame by frame

8 Press the OK button.

A confirmation dialog appears.

9 Use the four-way controller (▲▼) to select [Divide].

10 Press the OK button.

The movie is divided at the specified position, the two portions are saved as new files, and the original one is deleted.

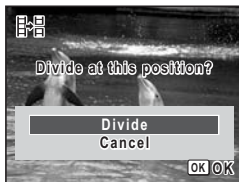

Setting the Printing Service (DPOF)

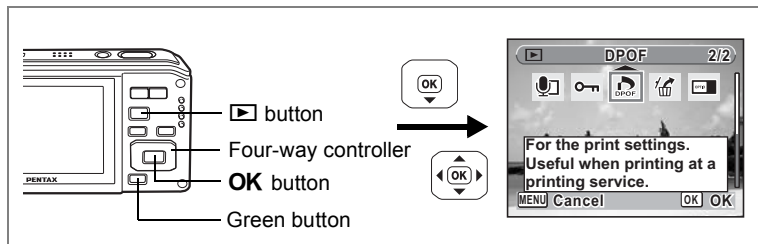

DPOF (Digital Print Order Format) is the format for storing print order data on still pictures captured with a digital camera. Once the print order data has been stored, the pictures can be printed according to the DPOF settings using a DPOF-compatible printer or photo processing lab. You cannot store print order data for movies or sound-only files.



Printing Single Images

Set the following items for each image.

Copies	Choose the number of copies up to 99.
Date	Specify whether you want the date inserted on the print or not.

- 1 In  mode, press the four-way controller (▼).**
The Playback Mode Palette appears.
- 2 Use the four-way controller (▲▼◀▶) to select  (DPOF).**
- 3 Press the OK button.**
The screen for selecting [Single Image] or [All Images] appears.
- 4 Use the four-way controller (▲▼) to select [Single Image].**



5 Press the **OK** button.

The message [DPOF setting for this image] appears.

To make DPOF settings for another image, use the four-way controller (◀▶) to select another image.

If DPOF settings have already been made for an image, the previous number of copies and date setting (☑ or ☐) will be displayed.



6 Use the four-way controller (▲▼) to choose the number of copies.

7 Use the Green button to choose whether to insert the date or not.

☑ (On) : The date will be imprinted.

☐ (Off) : The date will not be imprinted.

To continue setting DPOF print order data, use the four-way controller (◀▶) to choose another image and repeat Steps 6 and 7.



8 Press the **OK** button.

The DPOF settings are saved and the screen returns to the DPOF menu.

Caution

- Depending on the printer or printing equipment at the photo processing lab, the date may not be imprinted on the pictures even if ☑ (On) was selected in the DPOF settings.
- If the picture already has the date imprinted on it (p.127), do not set Date ☑ (On) in DPOF settings. Otherwise, the date could be imprinted twice on your printed picture.

memo

To cancel DPOF settings, set the number of copies to [00] in Step 6 and press the **OK** button.

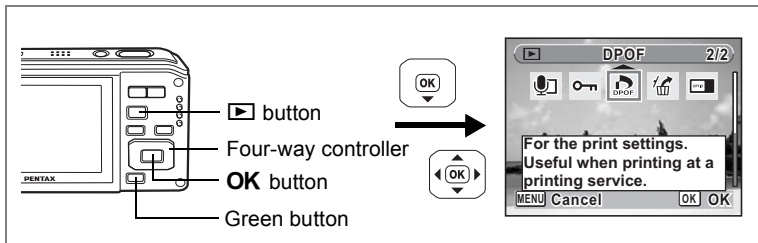

Printing All Images

When you choose the number of copies and whether or not to insert the date, the settings are applied to all the images stored in the camera.

- 1 Display the screen for DPOF settings in mode.**
Refer to Steps 1 to 3 on p.177.
- 2 Use the four-way controller () to select [All Images].**
- 3 Press the OK button.**

The message [DPOF setting for all images] appears.

- 4 Choose the number of copies and whether to insert the date or not.**

Refer to Steps 6 and 7 in "Printing Single Images" (p.178) for details of how to make the settings.

- 5 Press the OK button.**

The DPOF settings for all the images are saved and the camera returns to the DPOF setting screen.



- The number of copies specified in the DPOF settings applies to all the images. Before printing, check that the number is correct.
- If the pictures already have the date imprinted on them (p.127), do not set Date (On) in DPOF settings. Otherwise, the date could be imprinted twice on your printed pictures.



Settings for single images are canceled when settings are made for all images.



Printing Using PictBridge

By connecting the camera to a printer that supports PictBridge using the USB cable (I-USB7) provided, you can print images directly from the camera without using a computer. Connect the camera to the printer and select the images you want to print and the number of copies on the camera.



- You are recommended to use the AC adapter kit K-AC78 when the camera is connected to the printer. The printer may not work properly or the image data may be lost if the battery runs out of power while the camera is connected to the printer.
- Do not disconnect the USB cable during data transfer.
- Depending on the model of printer, not all the settings made on the camera (such as print settings and DPOF settings) may be valid.
- A printing error may occur if the selected number of copies exceeds 500.
- Printing the index of the images (printing multiple images on a single sheet) cannot be performed directly from the camera. Make the settings on a printer supporting index printing function or use a computer.

6

Connecting the Camera to the Printer

- 1 Select [PictBridge] for the [USB Connection] mode on the [Setting] menu.**
Refer to “Changing the USB Connection Mode” (p.201).
- 2 Turn off the camera.**
- 3 Connect the camera to the printer using the USB cable provided.**
- 4 Turn the printer on.**
- 5 When the printer is ready to print, turn the camera on.**

The printing mode selection screen appears.

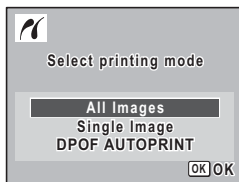

Printing Single Images

- 1 In the printing mode selection screen, use the four-way controller (▲▼) to select [Single Image].**
- 2 Press the OK button.**
The setting screen appears.
- 3 Use the four-way controller (◀▶) to choose an image to print.**
- 4 Use the four-way controller (▲▼) to choose the number of copies.**
You can print up to 99 copies.
- 5 Use the Green button to choose whether to insert the date or not.**
 (On) : The date will be imprinted.
 (Off) : The date will not be imprinted.
- 6 Press the OK button.**
A confirmation dialog appears.
To print the pictures according to the print settings on the printer, press the **OK** button.
To change the print settings, go to Step 7.
- 7 Press the Green button.**
The screen for changing the print settings appears.
- 8 Select [Paper Size] and press the four-way controller (▶).**
The Paper Size screen appears.

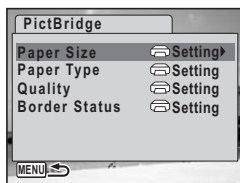
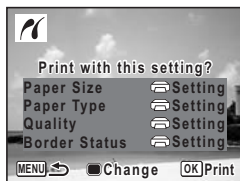
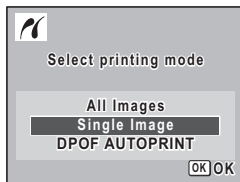

9 Use the four-way controller (▲▼◀▶) to choose the paper size.

You can only choose a size that is supported by your printer.

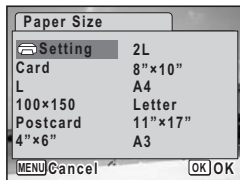

10 Press the OK button.

The Paper Size setting is saved and the screen returns to the print settings screen.

11 Use the four-way controller (▲▼) to select [Paper Type] and press the four-way controller (▶).

A pull-down menu appears.

12 Use the four-way controller (▲▼) to select the paper type and press the OK button.

The Paper Type setting is saved and the screen returns to the print settings screen. Set [Quality] and [Border Status] in the same way as in Steps 11 and 12.

If you select [Setting] for each print setting, images are printed according to the settings made on the printer.

Paper Type with more ★ supports higher quality paper.

Quality with more ★ indicates higher print quality.

A confirmation dialog appears after each item has been set.

13 Press the MENU button.

The screen returns to the confirmation dialog.

14 Press the OK button.

The image is printed according to the settings.

Press the **MENU** button to cancel printing.



- The power lamp lights while the camera is communicating with the printer, and blinks while the SD Memory Card is being accessed, for example while printing. Do not disconnect the USB cable while the power lamp is blinking.
- The [Paper Size], [Paper Type], [Quality] and [Border Status] settings are reset to the defaults when the camera is turned off.
- If the picture already has the date imprinted on it (p.127), do not set Date (On) in DPOF settings. Otherwise, the date could be imprinted twice on your printed picture.

Disconnecting the Cable from the Printer p.184

Printing All Images

- 1 In the printing mode selection screen, use the four-way controller (▲▼) to select [All Images].**

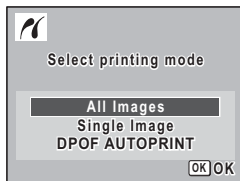

- 2 Press the OK button.**

The setting screen appears.

- 3 Choose the number of copies and whether to insert the date or not.**

The number of copies and date setting that you choose apply to all the images.

Refer to Steps 4 and 5 in “Printing Single Images” (p.181) for details of how to make the settings.



- 4 Press the OK button.**

A confirmation dialog appears.

Refer to Steps 7 to 13 of “Printing Single Images” (p.181 and p.182) for details of changing print settings.

- 5 Press the OK button on the print settings confirmation screen.**

All the images are printed according to the settings.

Press the **MENU** button to cancel printing.



If the pictures already have the date imprinted on them (p.127), do not set Date (On) in DPOF settings. Otherwise, the date could be imprinted twice on your printed pictures.

Printing Using the DPOF Settings

1 In the printing mode selection screen, use the four-way controller (▲▼) to select [DPOF AUTOPRINT].

2 Press the **OK** button.

The DPOF settings you have made appear. Use the four-way controller (◀▶) to check the number of copies for each picture, whether to insert the date or not, and the total number of copies. Refer to p.177 for instructions on how to make the DPOF settings.

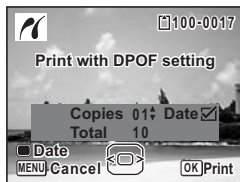

3 Press the **OK** button.

A confirmation dialog appears.

Refer to Steps 7 to 13 of “Printing Single Images” (p.181 and p.182) for details of changing print settings.

4 Press the **OK** button.

The images are printed according to the settings.

Press the **MENU** button to cancel printing.

6



If the picture already has the date imprinted on it (p.127), do not set Date (On) in DPOF settings. Otherwise, the date could be imprinted twice on your printed picture.

Disconnecting the Cable from the Printer

Disconnect the USB cable from the camera and printer when you have finished printing.



1 Turn off the camera.

2 Disconnect the USB cable from the camera and printer.

Recording Sound (Voice Recording Mode)

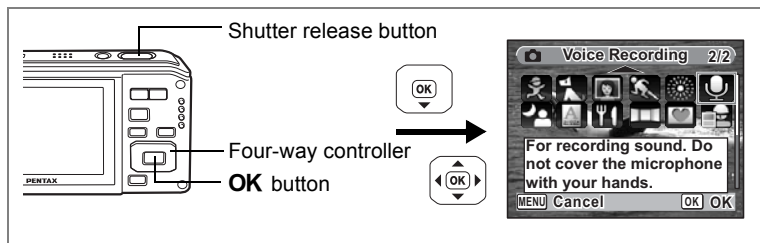
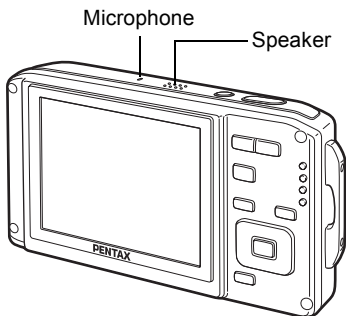
You can record sound with the camera. The microphone is located on the top of the camera. When recording sound, aim the camera to get the best results.



- 1 Press the four-way controller (▼) in  mode.**
The Capture Mode Palette appears.
- 2 Use the four-way controller (▲▼◀▶) to select  (Voice Recording).**

3 Press the OK button.

The remaining recordable time and the recording time of the current file appear on the display.

- 1 Recording time
- 2 Remaining recordable time



4 Press the shutter release button fully.

Recording starts. The self-timer lamp blinks during recording.

You can record sounds continuously for up to 24 hours.

When the Green button is pressed during recording, an index is added to the current sound file.



5 Press the shutter release button fully.

Recording stops.





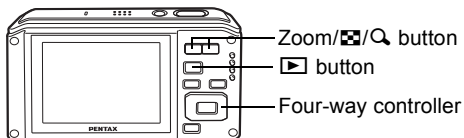

- If you press and hold down the shutter release button for more than one second in Step 4, recording continues until you take your finger off the button. This is useful for making short sound recordings, such as for the user sound in the [Sound] menu.
- Sound is saved in WAVE monaural files.

Playing Back Sound

You can play back the sound files you made in  mode.



- 1 Press the  button.
- 2 Use the four-way controller ( ) to choose a sound file to play back.
- 3 Press the four-way controller ().



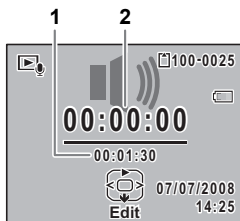

The sound file is played back.

1 Total file recording time

2 Playback time





The following operations can be performed during playback.

- Four-way controller () Pauses playback
- Zoom//Quick button () Increases the volume
- Zoom//Quick button () Reduces the volume



If there are no recorded indexes:

- Four-way controller () Reverses playback
- Four-way controller () Fast forwards playback

If there are recorded indexes:

- Four-way controller () Plays back starting from the previous index
- Four-way controller () Plays back starting from the next index

The following operations can be performed while playback is paused.

- Four-way controller () Resumes playback
- Four-way controller () Rewinds approx. 5 seconds
- Four-way controller () Advances approx. 5 seconds

- 4 Press the four-way controller ().

Playback stops.

Adding a Voice Memo to Images

You can add a voice memo to your still pictures.

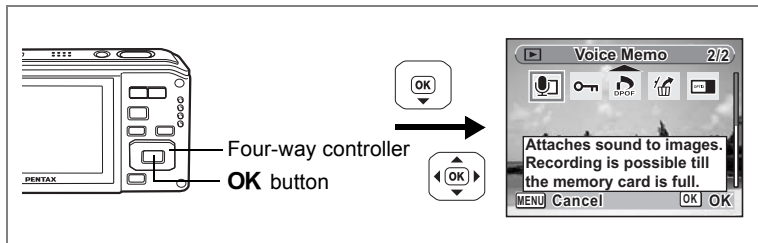

Recording a Voice Memo

- 1 Enter  mode and use the four-way controller (◀▶) to choose the still picture to which you want to add a voice memo.**
- 2 Press the four-way controller (▼).**

The Playback Mode Palette appears.
- 3 Use the four-way controller (▲▼◀▶) to select  (Voice Memo).**
- 4 Press the OK button.**

Recording starts. You can record a voice memo continuously for up to 24 hours.
- 5 Press the OK button.**

Recording stops.



- A voice memo cannot be added to an image that already has a voice memo. Delete the old voice memo and record a new one. (p.157)
- A voice memo cannot be added to protected () images (p.162).

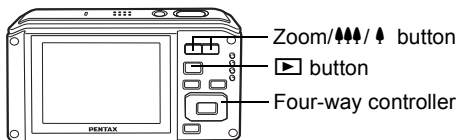

Playing Back a Voice Memo

- 1 Enter  mode and use the four-way controller (◀▶) to choose the still picture with the voice memo that you want to play back.**

 appears on images with voice memos in single-image display.



- 2 Press the four-way controller (▲).**

Playback starts.

The following operations can be performed during playback.

- Zoom/▲▲▲/▲ button (▲) Increases the volume
- Zoom/▲▲▲/▲ button (▲▲▲) Reduces the volume

- 3 Press the four-way controller (▼).**

Playback stops.

Deleting a Sound File  p.157

Camera Settings

How to display the [Setting] menu

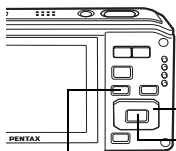

MENU button

Four-way controller

OK button

MENU

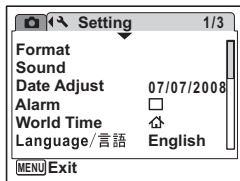

Formatting an SD Memory Card

Formatting will delete all the data on the SD Memory Card.



- Do not remove the SD Memory Card during formatting as this may damage the card and render it unusable.
- Formatting will delete protected images and any data recorded on the card with a camera other than this camera.
- SD Memory Cards formatted on a computer or device other than the camera cannot be used. Be sure to format the card with the camera.
- Built-in memory can only be formatted when there is an error.

1 Use the four-way controller (▲▼) to select [Format] on the [Setting] menu.

2 Press the four-way controller (▶).

The Format screen appears.

3 Use the four-way controller (▲▼) to select [Format].

4 Press the OK button.

When formatting is completed, the camera returns to Capture mode or Playback mode.

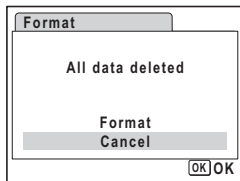

How to display the [↖ Setting] menu

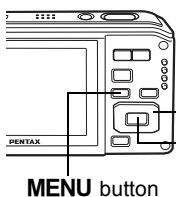

MENU

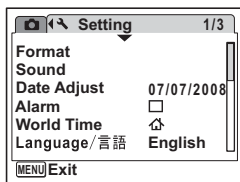

Changing the Sound Settings

You can adjust the volume of operation sounds and change the type of sound.

- 1 Use the four-way controller (▲▼) to select [Sound] on the [↖ Setting] menu.**
- 2 Press the four-way controller (▶).**
The Sound screen appears.

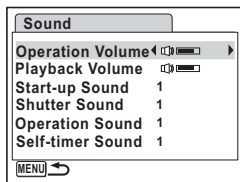

Changing the Operation Volume/Playback Volume

- 3 Use the four-way controller (▲▼) to select [Operation Volume].**
- 4 Use the four-way controller (◀▶) to adjust the volume.**
The selected volume is saved.
Set the volume to 0 to mute the start-up sound, shutter sound, operation sound, and self-timer sound.
- 5 Change [Playback Volume] in the same way as in Steps 3 to 4.**

Changing the Sound Type

- 6 Use the four-way controller (▲▼) to select [Start-up Sound].**

7 Press the four-way controller (▶).

A pull-down menu appears.

8 Use the four-way controller (▲▼) to select [1], [2], [3], [Off] or [USER] and press the OK button.

The selected sound type is saved.

9 Set [Shutter Sound], [Operation Sound] and [Self-timer Sound] in the same way as in Steps 6 to 8.

10 Press the MENU button.

The setting is changed and the screen returns to the [↖ Setting] menu.

Changing the Sound (Using a Recorded Sound File)

You can use a sound recorded by the camera for sound settings. The first two seconds of the selected sound file will be played as the [USER] sound.

1 Select [USER] in Step 8 in “Changing the Sound Type”.

2 Press the OK button.

The playback screen for the recorded sound files appears.

3 Use the four-way controller (◀▶) to select a sound file.

Play back the selected file to confirm.

Four-way controller (▲): Plays back the first two seconds of the sound file.

Four-way controller (▼): Stops playback.

4 Press the OK button.

The selected sound is set as the [USER] sound.

5 Set [Shutter sound], [Operation Sound] and [Self-timer Sound] in the same manner.

6 Press the MENU button.

The setting is changed and the screen returns to the [↖ Setting] menu.



The Sound settings are saved when the camera is turned off.

How to display the [Setting] menu

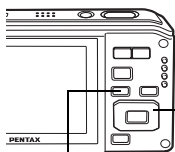

MENU button

MENU

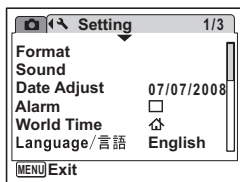

Changing the Date and Time

You can change the initial date and time settings. You can also set the style in which the date appears on the camera.

1 Use the four-way controller (▲▼) to select [Date Adjust] on the [Setting] menu.

2 Press the four-way controller (▶).

The Date Adjust screen appears.

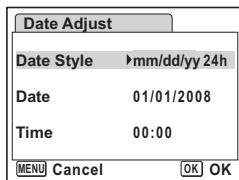

3 Press the four-way controller (▶).

The frame moves to [mm/dd/yy].

Depending on the initial setting or previous setting, [dd/mm/yy] or [yy/mm/dd] may be displayed.

4 Use the four-way controller (▲▼) to choose the date and time display style.

Choose [mm/dd/yy], [dd/mm/yy] or [yy/mm/dd].

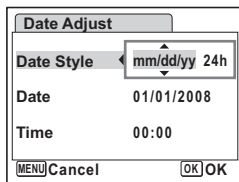

5 Press the four-way controller (▶).

The frame moves to [24h].

6 Use the four-way controller (▲▼) to select [24h] (24-hour display) or [12h] (12-hour display).

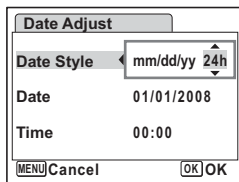

7 Press the four-way controller (▶).

The frame returns to [Date Style].

8 Press the four-way controller (▼).

The frame moves to [Date].

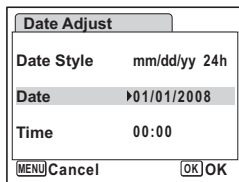

9 Press the four-way controller (▶).

The frame moves to one of the following items depending on the date style set in Step 4.

For [mm/dd/yy] month (Example: [01])

For [dd/mm/yy] day (Example: [01])

For [yy/mm/dd] year (Example: [2008])

The following operations and screens use [mm/dd/yy] as an example. The operations are the same even if another date style has been selected.

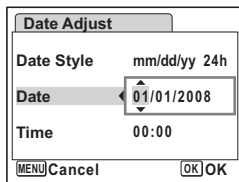

10 Use the four-way controller (▲ ▼) to change the month.

11 Press the four-way controller (▶).

The frame moves to the day field. Use the four-way controller (▲ ▼) to change the day. After changing the day, change the year in the same manner.

8

12 Change the time in the same way as in Steps 7 to 10.

If you selected [12h] in Step 6, the setting switches between am and pm corresponding to the time.

13 Press the OK button.

The date and time settings are saved.



When you finish the settings and press the **OK** button, the camera clock is reset to 00 seconds. To set the exact time, press the **OK** button when the time signal (on the TV, radio, etc.) reaches 00 seconds.

How to display the [Setting] menu

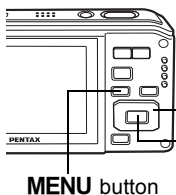

MENU

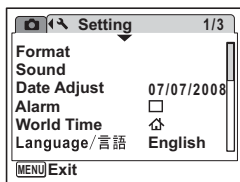
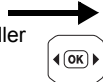

Setting the Alarm

You can set the alarm to ring at a specified time.

You can choose whether the alarm will ring at the same time every day or only once at the set time.

Setting the Alarm

- 1 Use the four-way controller (▲▼) to select [Alarm] on the [Setting] menu.**
- 2 Press the four-way controller (▶).**
The Alarm screen appears.
- 3 Press the four-way controller (▶).**
A pull-down menu appears.
- 4 Use the four-way controller (▲▼) to select [Off], [Once] or [Everyday] and press the OK button.**
- 5 Press the four-way controller (▼).**
Next, set the [Time].
- 6 Press the four-way controller (▶).**
The frame moves to the hour field.
- 7 Use the four-way controller (▲▼) to change the hour, then press (▶).**
The frame moves to the minute field.
Change the minutes in the same manner.

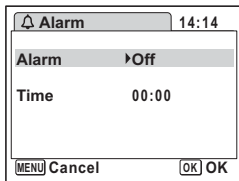

8 Press the OK button twice.

The screen returns to the [Setting] menu. Check that [Alarm] is set to (On).

9 Press the OK button.

[Alarm is set] appears and the camera turns off.

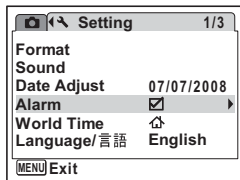

Checking the Alarm

1 Use the four-way controller (▲▼) to select [Alarm] on the [Setting] menu.

Check that [Alarm] is set to (On).

2 Press the four-way controller (▶).

The Alarm screen appears. Check the alarm frequency and time.

3 Press the MENU button twice.

The camera returns to capture status.

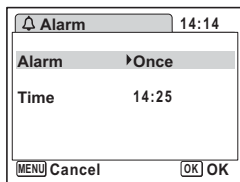

Turning the Alarm Off

The Clock mode screen appears and the alarm rings for one minute when the set time is reached while the camera is turned off. You can stop the alarm by pressing any button on the camera while the alarm is ringing.



- The alarm will not ring if the camera is on when the set time is reached.
- Even if an alarm is set, the alarm will not ring while interval shooting is being performed.

How to display the [↖ Setting] menu

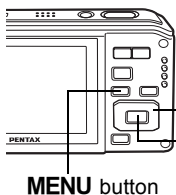

Four-way controller
OK button

MENU

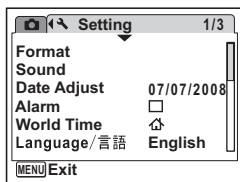
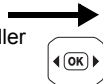

Setting the World Time

The date and time selected in “Setting the Date and Time” (p.41) and “Changing the Date and Time” (p.193) serve as the 🏠 (Hometown) date and time. By using the world time function, you can display the time in a city other than the Hometown (➔ Destination). This is useful when taking pictures in a different time zone.

Setting the Destination

- 1 Use the four-way controller (▲▼) to select [World Time] on the [↖ Setting] menu.**
- 2 Press the four-way controller (▶).**
The World Time screen appears.
- 3 Use the four-way controller (▲▼) to select ➔ (Destination).**
- 4 Press the four-way controller (▶).**
The Destination screen appears. The city that is currently selected blinks on the map.
- 5 Use the four-way controller (◀▶) to change the Destination city.**
The current time, location and time difference of the selected city appear.
- 6 Use the four-way controller (▲▼) to select [DST].**
- 7 Use the four-way controller (◀▶) to select (On) or (Off).**
Select (On) if the Destination city uses daylight saving time.

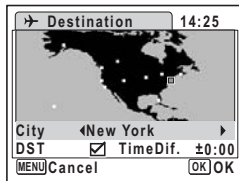
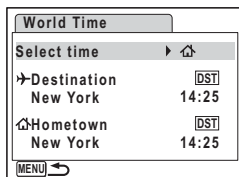

8 Press the OK button.

The Destination setting is saved.

9 Press the MENU button twice.

The camera returns to capture status with the current setting.



Select (Hometown) in Step 3 of p.197 to set the city and DST setting for the Hometown city.

Displaying the Time of the Destination on the display (Select Time)

1 Use the four-way controller (▲ ▼) to select [World Time] on the [Setting] menu.

2 Press the four-way controller (▶).

The World Time screen appears.

3 Use the four-way controller (▲ ▼) to select [Select time].

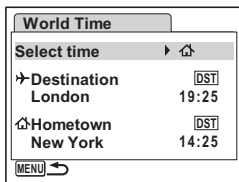

4 Press the four-way controller (▶).

A pull-down menu appears.

5 Use the four-way controller (▲ ▼) to select (Destination) or (Hometown).

: Displays the time in the city selected as the Destination city

: Displays the time in the city selected as the Hometown city

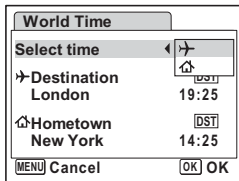

6 Press the OK button.

The Select time setting is saved.

7 Press the MENU button twice.

The camera returns to mode or mode.

(Destination) appears on the display when the camera returns to mode and World Time is selected.



How to display the [Setting] menu

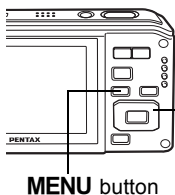

MENU

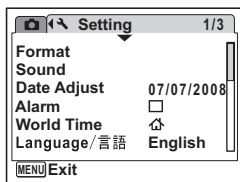
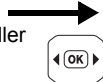

Changing the Display Language

You can change the language in which the menus, error messages, etc. are displayed.

The camera supports the following 20 languages: English, French, German, Spanish, Portuguese, Italian, Dutch, Danish, Swedish, Finnish, Polish, Czech, Hungarian, Turkish, Greek, Russian, Thai, Korean, Chinese (traditional and simplified) and Japanese.

- 1 Use the four-way controller (▲▼) to select [Language/言語] on the [Setting] menu.**
- 2 Press the four-way controller (▶).**
The [Language/言語] screen appears.
- 3 Use the four-way controller (▲▼◀▶) to select the language.**
- 4 Press the OK button.**



How to display the [Setting] menu

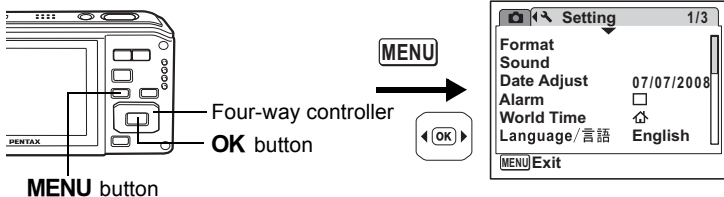

Changing the Image Folder Name

You can change the image folder name to Standard or Date. When the name is changed to the date, pictures are saved in separate folders by the date they were taken.

Folder Name

Standard	xxxPENTX (where xxx is the 3-digit folder number)
Date	xxx_mmdd (3-digit folder number_month day) * xxx_ddmm (3-digit folder number_day month) when the date style is set to [dd/mm/yy]

Picture taken with standard folder name
(Example: July 25)

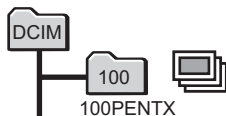

Folder name changed to date setting
(Example: July 25)

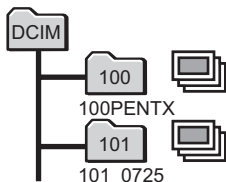

Next time a picture is taken
(Example: August 1)

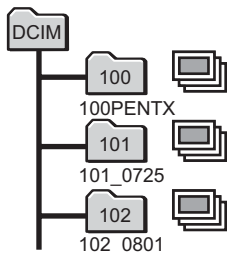

- Up to 900 folders can be created.
- Up to 999 images or sounds can be saved in a folder.

- 1 Use the four-way controller (▲▼) to select [Folder Name] on the [Setting] menu.**
- 2 Press the four-way controller (▶).**
A pull-down menu appears.
- 3 Use the four-way controller (▲▼) to select [Standard] or [Date].**
- 4 Press the OK button.**
The Folder Name setting is saved.

How to display the [Setting] menu

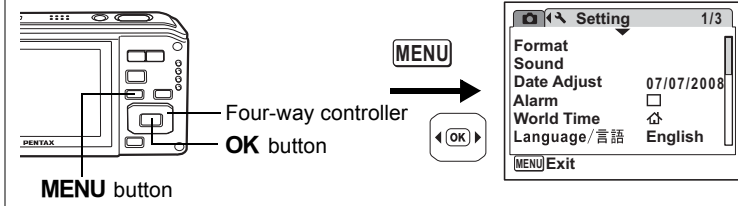

Changing the USB Connection Mode

Choose the appropriate USB connection mode depending on whether you are going to connect the USB cable to a computer or a PictBridge-compatible printer.



Refer to the PC Connection Manual for instructions on connecting the camera to a computer.

- 1 Use the four-way controller (▲▼) to select [USB Connection] on the [Setting] menu.**
- 2 Press the four-way controller (▶).**
A pull-down menu appears.
- 3 Use the four-way controller (▲▼) to select [PC] or [PictBridge].**
[PC] : Select this option when transferring image data to a computer
[PictBridge] : Select this option when connecting the camera to a PictBridge-compatible printer
- 4 Press the OK button.**

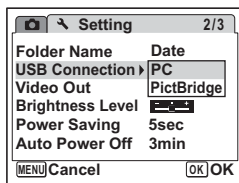

Do not connect the camera to your computer while [PictBridge] is selected for the USB Connection mode. And do not connect the camera to your printer while [PC] is selected.

How to display the [Setting] menu

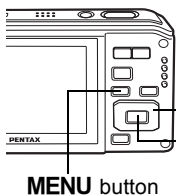

Four-way controller
OK button

MENU

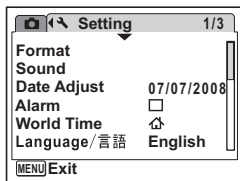
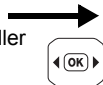

Changing the Video Output Format

When you connect the camera to AV equipment, choose the appropriate video output format (NTSC or PAL) for taking and playing back images.

1 Use the four-way controller (▲▼) to select [Video Out] on the [Setting] menu.

2 Press the four-way controller (▶).

A pull-down menu appears.

3 Use the four-way controller (▲▼) to select [NTSC] or [PAL].

Choose the video output format to match the output format of the AV equipment.

4 Press the OK button.

The Video Out setting is saved.

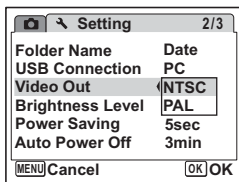

8

Settings



Depending on the country or region, images and sound files may fail to be played back if the video output format is set different from the one in use there. If this happens, change the video output format setting.

Connecting the Camera to AV Equipment p.154

How to display the [Setting] menu

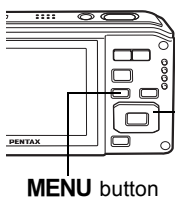

MENU

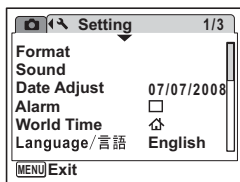

Adjusting the Brightness of the Display

You can adjust the brightness of the display.

- 1 Use the four-way controller (▲▼) to select [Brightness Level] on the [Setting] menu.**
- 2 Use the four-way controller (◀▶) to adjust the brightness.**

The following setting is saved.

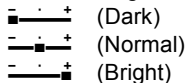

- 3 Press the MENU button.**

The camera returns to Capture mode or Playback mode.

The display is displayed with the set brightness. To change the brightness setting, perform the above steps again.

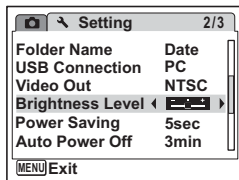

How to display the [Setting] menu

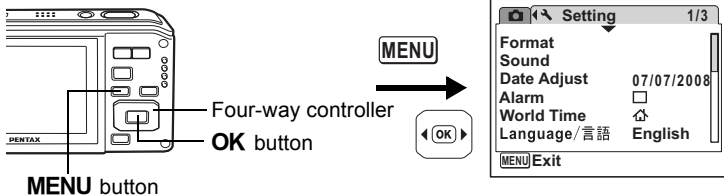

Using the Power Saving Function

You can save battery power by setting the display to dim automatically when no operation is performed for a fixed time. After the power saving function has been activated, the display returns to the ordinary brightness by pressing any of the buttons.

- 1 Use the four-way controller (▲▼) to select [Power Saving] on the [Setting] menu.**
- 2 Press the four-way controller (▶).**
A pull-down menu appears.
- 3 Use the four-way controller (▲▼) to select [2min], [1min], [30sec], [15sec], [5sec] or [Off].**
- 4 Press the OK button.**

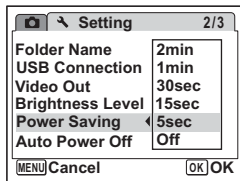

The Power Saving setting is saved.

8



- Power Saving does not function in the following situations:
 - while taking pictures in Continuous Shooting mode
 - in Playback mode
 - while the camera is connected to a computer or printer
 - when using the AC adapter
 - while recording a movie
 - while the menu is being displayed
- When no operation is performed after the camera is turned on, Power Saving is activated only after 15 seconds elapse even if [5sec] is selected.

How to display the [Setting] menu

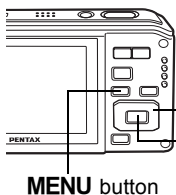

MENU

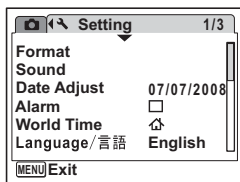
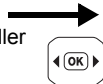

Setting Auto Power Off

You can set the camera to turn off automatically when no operation is performed for a fixed time.

- 1 Use the four-way controller (▲▼) to select [Auto Power Off] on the [Setting] menu.**
- 2 Press the four-way controller (▶).**
A pull-down menu appears.
- 3 Use the four-way controller (▲▼) to select [5min], [3min] or [Off].**
- 4 Press the OK button.**

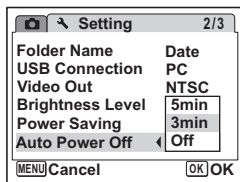

The Auto Power Off setting is saved.





Auto Power Off does not function in the following situations:

- while recording sound in (Voice Recording) mode
- while taking pictures in Continuous Shooting mode
- while recording a movie
- while playing back sound
- during a slideshow or movie playback
- while the camera is connected to a computer or printer

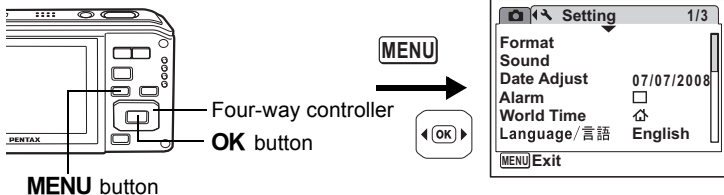
How to display the [Setting] menu





Setting the Quick Zoom Function

While playing back images in  mode, you can set whether to use Quick Zoom to enlarge the playback image to 10× when pressing the Zoom//Q button towards  once.

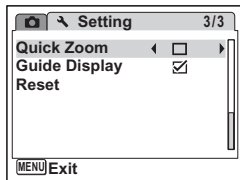
- 1 Use the four-way controller (▲▼) to select [Quick Zoom] on the [Setting] menu.**
- 2 Use the four-way controller (◀▶) to select (On) or (Off).**
 - (On): The Quick Zoom is available.
 - (Off): The Quick Zoom is not available.
- 3 Press the MENU button.**



The camera returns to  mode or  mode. Repeat the above steps to change the setting.

How to display the [Setting] menu

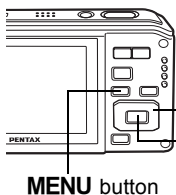

Four-way controller
OK button

MENU

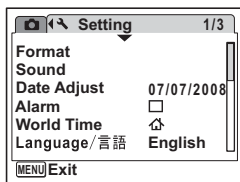
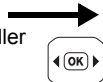

Setting the Guide Display

You can choose whether or not to display a guide for the mode you choose in the Capture Mode Palette (p.56) and Playback Mode Palette (p.62).

- 1 Use the four-way controller (▲▼) to select [Guide Display] on the [Setting] menu.**
- 2 Use the four-way controller (◀▶) to select (On) or (Off).**
 - (ON): The mode guide is displayed.
 - (OFF): The mode guide is not displayed.
- 3 Press the MENU button.**

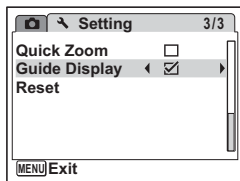

The camera returns to mode or mode. Repeat the above steps to change the setting.

How to display the [Setting] menu

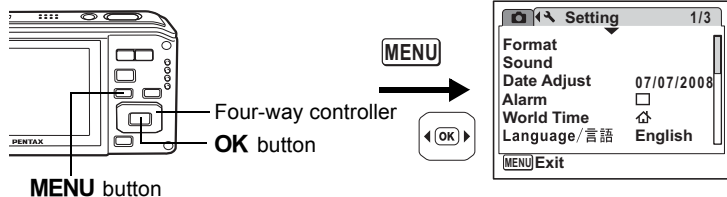

Resetting to Default Settings (Reset)

You can reset the camera settings to their defaults. Refer to “Default Settings” (p.213) for the reset settings.

- 1 Use the four-way controller (▲▼) to select [Reset] on the [Setting] menu.**
- 2 Press the four-way controller (▶).**
The Reset screen appears.
- 3 Use the four-way controller (▲▼) to select [Reset].**
- 4 Press the OK button.**
The settings return to the defaults.

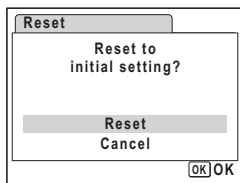
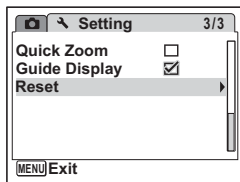

The following settings are not affected by resetting:
Date Adjust, Language/言語, World Time, Video Out.







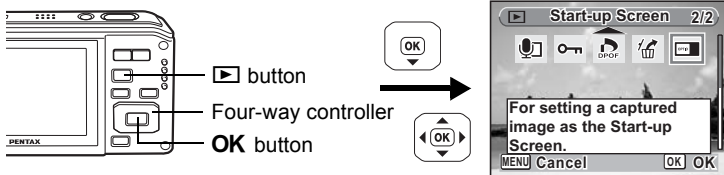





Resetting the camera deletes the Frame Composite frames, but not the default frames. Frame Composite frames can be copied from the included CD-ROM (S-SW81) as necessary. (p.72)

How to display the Playback Mode Palette



Changing the Start-up Screen

You can choose an image to be displayed as the start-up screen when the camera is turned on.

- 1 Press the  button.**
The camera enters  mode.
- 2 Press the four-way controller (.**
The Playback Mode Palette appears.
- 3 Use the four-way controller (   ) to select .**
- 4 Press the OK button.**
The image selection screen appears.
- 5 Use the four-way controller ( ) to choose an image for the start-up screen.**
- 6 Press the OK button.**
The Start-up Screen setting is saved.



- Once the start-up screen has been set, it will not be deleted even if the original image is deleted or the SD Memory Card is formatted.
- Select [Off] to hide the start-up screen.
- You cannot set images taken with  (16:9) as the Start-up Screen.

Displaying the Clock Mode

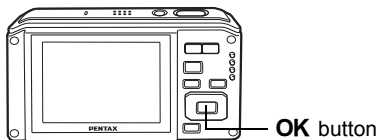

You can use the camera as a clock. With the camera turned off, press and hold down the **OK** button to display the clock on the display.

1 Press and hold down the **OK** button.

The camera turns on and the clock appears on the screen.

The camera turns off automatically after approximately 10 seconds.

Pressing the power switch turns the camera off immediately.



Memo

List of World Time Cities

The column "City" indicates cities that can be set as either the Initial Setting (p.39) or the World Time (p.197).

The column "Video Output Format" indicates the video output format of the city set as the Initial Setting.

Region	City	Video Output Format	Region	City	Video Output Format	
North America	Honolulu	NTSC	Africa/ West Asia	Istanbul	PAL	
	Anchorage	NTSC		Cairo	PAL	
	Vancouver	NTSC		Jerusalem	PAL	
	San Francisco	NTSC		Nairobi	PAL	
	Los Angeles	NTSC		Jeddah	PAL	
	Calgary	NTSC		Tehran	PAL	
	Denver	NTSC		Dubai	PAL	
	Chicago	NTSC		Karachi	PAL	
	Miami	NTSC		Kabul	PAL	
	Toronto	NTSC		Male	PAL	
	New York	NTSC		Delhi	PAL	
Halifax	NTSC	Colombo		PAL		
Central and South America	Mexico City	NTSC		Kathmandu	PAL	
	Lima	NTSC		Dacca	PAL	
	Santiago	NTSC		East Asia	Yangon	NTSC
	Caracas	NTSC			Bangkok	PAL
	Buenos Aires	PAL	Kuala Lumpur		PAL	
	Sao Paulo	PAL	Vientiane		PAL	
Rio de Janeiro	NTSC	Singapore	PAL			
Europe	Lisbon	PAL	Phnom Penh		PAL	
	Madrid	PAL	Ho Chi Minh		PAL	
	London	PAL	Jakarta		PAL	
	Paris	PAL	Hong Kong		PAL	
	Amsterdam	PAL	Beijing		PAL	
	Milan	PAL	Shanghai		PAL	
	Rome	PAL	Manila		NTSC	
	Copenhagen	PAL	Taipei		NTSC	
	Berlin	PAL	Seoul		NTSC	
	Prague	PAL	Tokyo	NTSC		
	Stockholm	PAL	Guam	NTSC		
	Budapest	PAL	Oceania	Perth	PAL	
	Warsaw	PAL		Adelaide	PAL	
	Athens	PAL		Sydney	PAL	
Helsinki	PAL	Noumea		PAL		
Moscow	PAL	Wellington		PAL		
Africa/ West Asia	Dakar	PAL		Auckland	PAL	
	Algiers	PAL		Pago Pago	NTSC	
	Johannesburg	PAL				

Default Settings

The table below lists the factory default settings.

The meaning of the indications for menu items with a default setting is explained below.

Last Memory Setting

Yes : The current setting (last memory) is saved when the camera is turned off.

No : The setting returns to the default setting when the camera is turned off.

* : The setting depends on the [Memory] setting (p.128).

— : NA

Reset Setting



Yes : The setting returns to the default setting with the Reset function (p.208).

No : The setting is saved even after reset.



— : NA

● [📷 Rec.Mode] Menu Items

Item		Default Setting	Last Memory Setting	Reset Setting	Page	
Recorded Pixels		(3648×2736)	Yes	Yes	p.104	
Quality Level		★★ (Better)	Yes	Yes	p.107	
White Balance		AWB (Auto)	*	Yes	p.108	
Focusing Area		(Multiple)	Yes	Yes	p.115	
AE Metering		(Multi-segment)	*	Yes	p.110	
Sensitivity		AUTO 800	*	Yes	p.112	
EV Compensation		±0.0	*	Yes	p.97	
Movie	Recorded Pixels/Frame Rate	(1280×720):15fps	Yes	Yes	p.133	
	Color Mode	Full Color	Yes	Yes	p.135	
	Movie SR	(On)	Yes	Yes	p.136	
	Interval Shoot	Interval	1 min	Yes	Yes	p.137
		Total Time	10 min	Yes	Yes	p.137
		Start Delay	In 0 hr 0 min	Yes	Yes	p.137
	AF w/ recording	<input type="checkbox"/> (Off)	Yes	Yes	p.140	
Optical Zoom	<input type="checkbox"/> (Off)	Yes	Yes	p.141		

Item		Default Setting	Last Memory Setting	Reset Setting	Page
Interval Shoot	Interval	10 sec	Yes	Yes	p.90
	Number of Shot	2 pictures	Yes	Yes	p.90
	Start Delay	In 0 hr 0 min	Yes	Yes	p.90
Blink Detection		<input checked="" type="checkbox"/> (On)	Yes	Yes	p.61
Digital Zoom		<input checked="" type="checkbox"/> (On)	*	Yes	p.96
Instant Review		1 sec	Yes	Yes	p.120
Memory	Face Priority	<input type="checkbox"/> (Off)	Yes	Yes	p.59
	Flash Mode	<input checked="" type="checkbox"/> (On)	Yes	Yes	p.102
	Drive Mode	<input type="checkbox"/> (Off)	Yes	Yes	p.87 - p.93
	Focus Mode	<input type="checkbox"/> (Off)	Yes	Yes	p.100
	Zoom Position	<input type="checkbox"/> (Off)	Yes	Yes	p.94
	MF Position	<input type="checkbox"/> (Off)	Yes	Yes	p.101
	White Balance	<input type="checkbox"/> (Off)	Yes	Yes	p.108
	Sensitivity	<input type="checkbox"/> (Off)	Yes	Yes	p.112
	EV Compensation	<input type="checkbox"/> (Off)	Yes	Yes	p.97
	AE Metering	<input type="checkbox"/> (Off)	Yes	Yes	p.110
	Digital Zoom	<input checked="" type="checkbox"/> (On)	Yes	Yes	p.96
DISPLAY	<input type="checkbox"/> (Off)	Yes	Yes	p.98, p.148	
File No.	<input checked="" type="checkbox"/> (On)	Yes	Yes	—	
Green Button		Green Mode	Yes	Yes	p.121
Sharpness		 (Normal)	Yes	Yes	p.124
Saturation		 (Normal)	Yes	Yes	p.125
Contrast		 (Normal)	Yes	Yes	p.126
Date Imprint		Off	Yes	Yes	p.127















● [ Setting] Menu Items

Item		Default Setting	Last Memory Setting	Reset Setting	Page
Format		Cancel	—	—	p.190
Sound	Operation Volume	3	Yes	Yes	p.191
	Playback Volume	3	Yes	Yes	
	Start-up Sound	1	Yes	Yes	
	Shutter Sound	1	Yes	Yes	
	Operation Sound	1	Yes	Yes	
	Self-timer Sound	1	Yes	Yes	
Date Adjust	Date Style (date)	According to initial setting	Yes	No	p.41
	Date Style (time)	24h	Yes	No	
	Date	1/1/2008	Yes	No	
	Time	According to initial setting	Yes	No	
Alarm	Alarm	<input type="checkbox"/> (Off)	Yes	Yes	p.195
	Time	0:00	Yes	Yes	
World Time	Select time	Same as  hometown	Yes	Yes	p.197
	Destination (City)	According to initial setting	Yes	No	
	Destination (DST)	According to initial setting	Yes	No	
	Hometown (City)	According to initial setting	Yes	No	
	Hometown (DST)	According to initial setting	Yes	No	
Language/言語		According to initial setting	Yes	No	p.39
Folder Name		Date	Yes	Yes	p.200
USB Connection		PC	Yes	Yes	p.201
Video Out		According to initial setting	Yes	No	p.202
Brightness Level		 (4)	Yes	Yes	p.203
Power Saving		5 sec	Yes	Yes	p.204
Auto Power Off		3 min	Yes	Yes	p.205
Quick Zoom		<input type="checkbox"/> (Off)	Yes	Yes	p.206
Guide Display		<input checked="" type="checkbox"/> (On)	Yes	Yes	p.207
Reset		Off	—	—	p.208

● Playback Mode Palette Items

Item		Default Setting	Last Memory Setting	Reset Setting	Page
Digital SR		—	—	—	p.149
Slideshow	Interval	3 sec	Yes	Yes	p.151
	Screen Effect	Wipe	Yes	Yes	
	Sound Effect	<input checked="" type="checkbox"/> (On)	Yes	Yes	
Resize	Recorded Pixels	Depending on the picture taken	—	—	p.164
	Quality Level	Depending on the picture taken	—	—	
Cropping		Depending on the picture taken	—	—	p.166
Image/Sound Copy		Built-in memory → SD Memory Card	—	—	p.167
Image Rotation		Normal	—	—	p.46
Digital Filter		B&W	No	—	p.169
Movie Edit	Save as Still image	—	—	—	p.175
	Divide Movies	—	—	—	
Frame Composite		Default1	Yes	Yes	p.173
Red-eye Compensation		—	—	—	p.172
Voice Memo		—	—	—	p.188
Protect	Single Image/Sound	Depending on the recorded image/sound	—	—	p.162
	All Images/Sounds	Depending on the recorded image/sound	—	—	
DPOF	Single Image	Copies: 0	—	—	p.177
	All Images	Date: <input type="checkbox"/> (Off)	—	—	p.179
Image Recovery		Cancel	—	—	p.161
Start-up Screen		Off	Yes	Yes	p.209

● Key Operation

Item	Function	Default Setting	Last Memory Setting	Reset Setting	Page
 button	Operation Mode	 mode	—	—	—
Zoom/  /Zoom out/  button	Zoom Position	Full wide-angle	*	No	p.94
Four-way controller	 Drive Mode	 (Standard)	*	Yes	p.87 - p.93
	 Shooting Mode	 (Auto Picture)	Yes	Yes	p.56
	 Flash Mode	 (Auto)	*	Yes	p.102
	 Focus Mode	AF (Standard)	*	Yes	p.100
MENU button	Menu Display	Capture mode:  [Rec.Mode] menu Playback mode:  [Setting] menu	—	—	p.51
OK/DISPLAY button	Information Display	Normal	*	Yes	p.98, p.148
 button	Operation Mode	Face Priority On	*	Yes	p.59















Functions Available for Each Shooting Mode

















Yes : Can be set and function is available. No : Cannot be set.

: Can be set but function is not available.

Face Priority	Yes	Yes	Yes	Yes	Yes	No	Yes	Yes
Smile Capture	Yes	Yes	Yes	Yes	Yes	No	Yes	Yes
Face Priority Off	No	Yes	Yes	Yes	Yes	No	Yes	No
(Auto)	Yes	Yes	Yes	No	No*4	No	Yes	Yes
(Flash Off)	Yes	Yes	Yes	Yes	Yes*4	No	Yes	Yes
(Flash On)	Yes	No	Yes	Yes	No*4	No	Yes	Yes
(Auto + Red-eye)	Yes	No	Yes	No	No*4	No	Yes	Yes
(Flash On + Red-eye)	Yes	No	Yes	Yes	No*4	No	Yes	Yes
(Soft Flash)	Yes	No	Yes	Yes	No*4	No	Yes	Yes
(Single-frame shooting)	Yes	Yes	Yes	Yes	Yes	No	Yes	Yes
(Self-timer)	Yes	Yes*1	Yes	Yes	Yes	No	Yes	Yes
(2 sec. Self-timer)	Yes	Yes*1	Yes	Yes	Yes	No	Yes	Yes
(Continuous Shooting)	No	No	Yes	No	No	No	Yes	Yes
(HS Cont. Shooting)	No	No	Yes	No	No	No	Yes	Yes
Interval Shoot	No	No	Yes	Yes	Yes	No	Yes	Yes
Auto Bracket	No	No	Yes	Yes	No	No	Yes	Yes
AF (Standard)	Yes	Yes	Yes	Yes	Yes	No	Yes	Yes
(Macro)	Yes	Yes	Yes	Yes	Yes	No	Yes	Yes
(1cm Macro)	Yes	No	Yes	Yes	Yes	No	Yes	Yes
(Infinity)	Yes	No	Yes	Yes	Yes	No	Yes	Yes
PF (Pan Focus)	Yes	Yes	Yes	Yes	Yes	No	Yes	Yes
MF (Manual Focus)	Yes	No	Yes	Yes	Yes	No	Yes	Yes
Recorded Pixels	Yes*18	No	Yes*18	Yes*18	#*5	#	Yes*18	Yes*18
Quality Level	Yes	No	Yes	Yes	No*25	#	Yes	Yes
White Balance	No*10	No*10	Yes	Yes	Yes	#*8	No*10	No*10
Focusing Area	No*11	No*11	Yes*19	Yes*19	Yes*12, 19	#	Yes*19	Yes*19
Focus Limiter	Yes	No*21	Yes	Yes	Yes	#	Yes	Yes
AE Metering	No*2,3	No*2	Yes*3	Yes*3	No*2,3	#	No*2,3	No*2,3
Sensitivity	Yes	No*15	Yes	Yes	No*15	#	Yes	Yes
EV Compensation	No	No	Yes	Yes	Yes*6	#	Yes	Yes
Digital Zoom	Yes	No*27	Yes	Yes	Yes	#	Yes	Yes
Instant Review	Yes	No	Yes	Yes	#	#	Yes	Yes
Memory	Yes	No	Yes	Yes	Yes*7	Yes*7	Yes	Yes
Sharpness	No	No	Yes	Yes	Yes	#	No	No
Saturation	No	No	Yes	Yes	Yes	#	No	No
Contrast	No	No	Yes	Yes	Yes	#	No	No
Date Imprint	Yes	No	Yes	Yes	#	#	Yes	Yes

						
Yes	Yes	Yes	Yes	Yes	Yes	Face Priority
Yes	Yes	Yes	Yes	Yes	Yes	Smile Capture
Yes	Yes	Yes	Yes	Yes	Yes	Face Priority Off
Yes	Yes	Yes	Yes	Yes	No*4	 (Auto)
Yes	Yes	Yes	Yes	Yes	Yes*4	 (Flash Off)
Yes	Yes	Yes	Yes	Yes	No*4	 (Flash On)
Yes	Yes	Yes	Yes	Yes	No*4	 (Auto + Red-eye)
Yes	Yes	Yes	Yes	Yes	No*4	 (Flash On + Red-eye)
Yes	Yes	Yes	Yes	Yes	No*4	 (Soft Flash)
Yes	Yes	Yes	Yes	Yes	Yes	 (Single-frame shooting)
Yes	Yes	Yes	Yes	Yes	Yes	 (Self-timer)
Yes	Yes	Yes	Yes	Yes	Yes	 (2 sec. Self-timer)
Yes	Yes	No	No	No	No	 (Continuous Shooting)
Yes	Yes	No	No	No	No	 (HS Cont. Shooting)
Yes	Yes	No	No	Yes	No	 Interval Shoot
Yes	Yes	No	No	No	No	 Auto Bracket
Yes	Yes	Yes	Yes	Yes	No*22	AF (Standard)
Yes	Yes	Yes	Yes	Yes	No*22	 (Macro)
Yes	Yes	Yes	No	Yes	No*22	 (1cm Macro)
Yes	Yes	Yes	Yes	Yes	Yes*22	 (Infinity)
Yes	Yes	Yes	Yes	Yes	No*22	PF (Pan Focus)
Yes	Yes	Yes	Yes	Yes	No*22	MF (Manual Focus)
Yes*18	No*17	No*16	No*13	No*20	Yes	Recorded Pixels
Yes	Yes	Yes	Yes	Yes	Yes	Quality Level
No*10	Yes	Yes	Yes	Yes	No*10	White Balance
Yes*19	Yes*19	Yes*19	Yes*19	Yes*12, 19	No*11	Focusing Area
Yes	Yes	Yes	Yes	Yes	No*21	Focus Limiter
No*2, 3	Yes	Yes	Yes*3	Yes	No*2, 3	AE Metering
Yes	No*9	Yes	Yes	Yes	No*23	Sensitivity
Yes	Yes	Yes	Yes	Yes	Yes	EV Compensation
Yes	No	Yes	#	Yes	Yes	Digital Zoom
Yes	Yes	Yes	Yes	Yes	Yes	Instant Review
Yes	Yes	Yes	Yes	Yes	Yes	Memory
No	Yes	Yes	Yes	Yes	No	Sharpness
No	Yes	Yes	Yes	Yes	No	Saturation
No	Yes	Yes	Yes	Yes	No	Contrast
Yes	Yes	Yes	Yes	Yes	Yes	Date Imprint

					
Face Priority	Yes	Yes	Yes	Yes	Yes
Smile Capture	Yes	Yes	Yes	Yes	Yes
Face Priority Off	No	Yes	Yes	Yes	Yes
 (Auto)	Yes	Yes	Yes	Yes	No*4
 (Flash Off)	Yes	Yes	Yes	Yes	Yes*4
 (Flash On)	Yes	Yes	Yes	Yes	No*4
 (Auto + Red-eye)	Yes	Yes	Yes	Yes	No*4
 (Flash On + Red-eye)	Yes	Yes	Yes	Yes	No*4
 (Soft Flash)	Yes	Yes	Yes	Yes	No*4
<input type="checkbox"/> (Single-frame shooting)	Yes	Yes	Yes	Yes	Yes
 (Self-timer)	Yes	Yes	Yes	Yes	Yes
 (2 sec. Self-timer)	Yes	Yes	Yes	Yes	Yes
 (Continuous Shooting)	Yes	Yes	Yes	Yes	No
 (HS Cont. Shooting)	Yes	Yes	Yes	Yes	No
 Interval Shoot	Yes	Yes	Yes	Yes	Yes
 Auto Bracket	Yes	Yes	Yes	Yes	No
AF (Standard)	Yes	Yes	Yes	Yes	Yes
 (Macro)	Yes	Yes	Yes	Yes	Yes
 (1cm Macro)	Yes	Yes	Yes	Yes	Yes
 (Infinity)	Yes	Yes	Yes	Yes	Yes
PF (Pan Focus)	Yes	Yes	Yes	Yes	Yes
MF (Manual Focus)	Yes	Yes	Yes	Yes	Yes
Recorded Pixels	No*20	Yes*18	No*24	Yes*18	#*5
Quality Level	Yes	Yes	Yes	Yes	No*25
White Balance	No*10	No*10	No*10	No*10	No*10
Focusing Area	Yes*19	Yes*12, 19	Yes*19	Yes*19	Yes*12, 19
Focus Limiter	Yes	Yes	Yes	Yes	Yes
AE Metering	No*2, 3	No*2, 3	No*2, 3	No*2, 3	No*2, 3
Sensitivity	Yes	Yes	Yes*26	Yes	No*15
EV Compensation	Yes	Yes	Yes	Yes	Yes
Digital Zoom	Yes	Yes	No	Yes	Yes
Instant Review	Yes	Yes	Yes	Yes	#
Memory	Yes	Yes	Yes	Yes	Yes*7
Sharpness	No	No	No	No	No
Saturation	No	No	No	No	No
Contrast	No	No	No	No	No
Date Imprint	Yes	Yes	Yes	Yes	#

- *1 If you select one of these functions in another shooting mode and then enter  (Green) mode, only the function selected is available
- *2 Fixed at  (Multi-segment)
- *3 Fixed at Face Recognition AE when the subject's face is recognized
- *4 Fixed at  (Flash Off)
- *5 Follows setting for [Movie]
- *6 Not available during recording
- *7 Some related settings are applied
- *8  (Manual) is not available
- *9 Fixed at AUTO 6400 (Sensitivity 50 - 6400)
- *10 Fixed at **AWB** (Auto White Balance)
- *11 Fixed at  (Multiple)
- *12  (Automatic Tracking AF) is not available
- *13 Stitched photos are fixed at  (however, the first frame uses )
- *14 Fixed at  (Automatic Tracking AF)
- *15 Fixed at AUTO 800 (Sensitivity 50 - 800)
- *16 Fixed at  for the first frame
- *17 Fixed at 
- *18 Fixed at  when the sensitivity is set to 3200 or 6400
- *19 Fixed at Face Recognition AF when the subject's face is recognized
- *20 Fixed at 
- *21 Fixed at Off
- *22 Fixed at  (Infinity)
- *23 Fixed at sensitivity 50
- *24 Fixed at  (1280×960)
- *25 Fixed at  (Best)
- *26 Only AUTO 6400 is available as an AUTO adjustment range
- *27 Fixed at On

Optional Accessories

A number of dedicated accessories are available for this camera. Products marked with an asterisk (*) are the same as those supplied with the camera.

- **Power supply**

- Rechargeable lithium-ion battery D-LI78 (*)**

- Battery charger kit K-BC78 (*)**

- (Battery charger D-BC78, AC plug cord D-CO2)

- AC adapter kit K-AC78**

- (AC adapter D-AC64, DC coupler D-DC78, AC plug cord D-CO2)

- The battery charger and AC plug cord are only sold as a set.

- **Cable**

- USB cable I-USB7 (*)**

- AV cable I-AVC7 (*)**

- **Strap**

- O-ST20 (*)**

- O-ST24** Genuine leather strap

- O-ST8** Silver chain strap

- O-ST30/O-ST81** Waterproof strap

- **Camera case**

- O-CC48**

- O-CC79**

- O-CC81**

- **Optio W60 Skin**

- O-CC812**

- This cover protects the camera from scratches and light impacts.

Messages

Messages such as the following may appear on the display during camera operation.

Message	Description
Battery depleted	The battery is exhausted. Charge the battery using the battery charger. (p.25)
Memory card full	The SD Memory Card is full and no more images can be saved.
The card memory is not enough to copy images/sounds	Insert a new SD Memory Card or delete unwanted images. (p.31, p.156) Change the quality level or recorded pixels of recorded images and try again. (p.164)
Memory card error	Shooting and playback are impossible due to a problem with the SD Memory Card. You may be able to display or copy the images on the card using a computer.
Card not formatted	The SD Memory Card you have inserted is unformatted or has been formatted on a computer or other device and is not compatible with this camera. Format the SD Memory Card in the camera. (p.190)
Card locked	The SD Memory Card is write-protected. (p.33)
Compression error	This message occurs when the camera fails to compress an image. Change the quality level or recorded pixels of the image and try shooting or saving it again.
No image/sound	There are no image/sound files on the SD Memory Card.
Movie recording stopped	This message appears when the internal temperature of the camera has exceeded normal operating limits while recording a movie.
Deleting	This message appears when deleting an image or sound file.
Camera cannot play this image and sound	You are trying to play back an image or sound in a format not supported by this camera. You may be able to play it back on another brand of camera or on your computer.
Image folder could not be created	The largest file number (9999) has been assigned to an image in the largest folder number (999) and no more images can be saved. Insert a new SD Memory Card or format the card. (p.190)
Protected	The image or sound file you are trying to delete is protected.

Message	Description
Data being recorded	This message appears when you try to switch to  mode while an image is still being recorded, when a file is being saved, or when the protect setting or DPOF setting is being changed. It disappears after the image is recorded or the setting is changed.
Data being processed	This message appears when the camera takes more than five seconds to display an image due to image processing, or when the SD Memory Card is being formatted.
Built-in memory full	Displayed when there is insufficient space available on the built-in memory to save a file.
No image to be processed	Displayed when there are no images or sound files.
This image/sound cannot be processed	Displayed for files that cannot be processed.
No card in the camera	Displayed when no SD card is inserted.
The built-in memory is not enough to copy images/sounds	Displayed when there is insufficient built-in memory to perform copying.
Cannot process correctly	Displayed when Red-eye Compensation processing fails.
Display image/sound from built-in memory	Displayed when the camera enters built-in memory mode.
Alarm is set	This message appears when the alarm is set and before the camera automatically turns off.









Messages such as the following may appear on the display when using the PictBridge function.

Message	Description
Low paper level in the printer	The paper level of the printer is low.
No paper in the printer	There is no paper in the printer.
Paper stuck in the printer	The paper is stuck in the printer.
Low ink level in the printer	The ink level of the printer is low.
No ink in the printer	There is no ink in the printer.
Printer error	An error message has been sent from the printer.
Data error	A data error message has been sent from the printer.
Connection error Check printer	Displayed when a PictBridge connection fails.
Printing now	Displayed when printing is being executed.

Message	Description
Printing is completed. Continue printing?	Displayed when printing completes.
Print Canceled	Displayed when printing is canceled.
No image to be processed	Displayed when there are no images to print.
Wrong DPOF setting	Displayed when DPOF printing cannot be performed.

Troubleshooting

Problem	Cause	Remedy
The camera will not turn on	The battery is not installed	Check if a battery is installed. If not, install a battery.
	The battery is installed incorrectly	Check orientation of the battery. Reinsert the battery according to the ⊕ ⊖ symbols in the battery compartment. (p.26)
	The battery is exhausted	Charge the battery.
No image appears on the display	The camera is connected to a computer	The display is off when the camera is connected to a computer.
	The camera is connected to a TV	The display is off when the camera is connected to a TV.
	The display is set to off	Press the OK/DISPLAY button to turn the display on. (p.98)
The display is hard to see	The brightness level of the display is set too dark	Adjust the brightness level in [Brightness Level] in the [Setting] menu. (p.203)
	Power Saving function is on	When the Power Saving function is on, the display automatically darkens after a certain amount of time. Press a button to return to the normal brightness level. Select [Off] in [Power Saving] in the [Setting] menu to turn the Power Saving function off. (p.204)
	The image is displayed but is hard to see	The image on the display may be hard to see when taking pictures outside in sunlight. Increase brightness of the display. (p.203)
The shutter will not release	The flash is charging	Pictures cannot be taken while the flash is charging. Wait until charging is finished.
	There is no available space on the SD Memory Card or in the built-in memory	Insert an SD Memory Card with available space or delete unwanted images. (p.31, p.156)
	Recording	Wait until recording is finished.

Problem	Cause	Remedy
The picture is dark when using the flash	The subject is too far away in a dark environment, such as a night scene	The picture becomes dark if the subject is too far away. Take pictures within the specified flash range.
The subject is not in focus	The subject is difficult to focus on with autofocus	The camera may have difficulty in focusing on such subjects as: low contrast subjects (a white wall, a blue sky, etc.), dark subjects, finely-patterned objects, rapidly-moving objects. It is also difficult to get proper focus when shooting through a window or a net. Try shooting using the focus lock (p.44) or Manual Focus (p.101).
	The subject is not in the focusing area	Locate the desired subject in the focus frame (focusing area) in the center of the display. If it is difficult to do so, first lock the focus on the desired subject (focus lock) and then move the camera to recompose.
The flash does not discharge	The flash mode is set to  (flash off)	Set to Auto or  (Flash On). (p.102)
	The drive mode is set to  or  The focus mode is set to  The shooting mode is set to  ,  or 	The flash does not discharge in these modes.
The USB connection with a personal computer does not function properly	The USB connection setting of the camera is set to [PictBridge]	Set the USB connection setting to [PC]. (p.201)
The USB connection with a printer does not function properly	The USB connection setting of the camera is set to [PC]	Set the USB connection setting to [PictBridge]. (p.180)

Very occasionally, static electricity may cause camera malfunction. In this case, remove the battery and install it again. If the camera is then working properly, normal condition is restored and you can continue using the camera.

Main Specifications

Type	Fully automatic compact digital still camera with built-in zoom lens	
Number of Effective Pixels	Approx. 10 megapixels	
Image Sensor	1/2.3 inch CCD	
Number of Recorded Pixels	Still	10M (3648×2736 pixels), 7.5M (16:9) (3648×2056 pixels) 7M (3072×2304 pixels), 5M (2592×1944 pixels) 3M (2048×1536 pixels), 1024 (1024×768 pixels) 640 (640×480 pixels)
		* Fixed at 5M (2592×1944) when the sensitivity is set to 3200 or 6400. * Fixed at 5M (2592×1944) in Digital SR mode. * Fixed at 5M (2592×1944) in Digital Wide mode. * Fixed at 1280 (1280×960) in Report mode. * Fixed at 3M (2048×1536) during Frame Composite mode. * Fixed at 3M (2048×1536) during Half-length Portrait mode. * Fixed at 2M (1600×1200) for 1 picture while taking panoramic pictures. * Fixed at 5M (2592×1944) during HS Cont. Shooting mode.
	Movie	1280 (1280×720):approx. 15fps, 640 (640×480):approx. 30/15fps, 320 (320×240):approx. 30/15fps (Unit:pixels/fps)
Sensitivity (Standard Output Sensitivity)	Auto, Fixed (ISO 50 - 6400)	* The sensitivity is fixed at AUTO (50 - 6400) in the Digital SR (Shake Reduction). * AUTO sensitivity is fixed at (50 - 6400) in Report mode.
File Format	Still	JPEG (Exif 2.2), DCF 2.0, DPOF, PictBridge, PRINT Image Matching III
	Movie	AVI (Motion JPEG), approx. 30fps/15fps, PCM system, monaural sound, full color/sepia/black and white, Movie SR (Movie Shake Reduction)
	Sound	Voice memo, voice recording: WAVE (PCM) system, monaural
Quality Level	Still	★★★ "Best", ★★ "Better", ★ "Good"
	Movie	Fixed at ★★★ (Best) *Unchangeable
Storage Media	Built-in memory (approx. 36.4 MB), SD Memory Card, SDHC Memory Card	

Approximate Image Storage Capacity and Recording Time

	★★★ (Best)		★★ (Better)		★ (Good)	
	Built-in Memory	512 MB	Built-in Memory	512 MB	Built-in Memory	512 MB
10M 3648×2736	9 pictures	117 pictures	17 pictures	228 pictures	24 pictures	321 pictures
7.5M (16:9) 3648×2056	12 pictures	156 pictures	22 pictures	287 pictures	29 pictures	377 pictures

	★★★ (Best)		★★ (Better)		★ (Good)	
	Built-in Memory	512 MB	Built-in Memory	512 MB	Built-in Memory	512 MB
7M 3072×2304	12 pictures	157 pictures	22 pictures	287 pictures	29 pictures	377 pictures
5M 2592×1944	14 pictures	188 pictures	27 pictures	355 pictures	38 pictures	503 pictures
3M 2048×1536	22 pictures	293 pictures	44 pictures	570 pictures	63 pictures	816 pictures
1280 1280× 960	49 pictures	643 pictures	86 pictures	1119 pictures	116 pictures	1511 pictures
1024 1024× 768	75 pictures	974 pictures	122 pictures	1590 pictures	155 pictures	2014 pictures
640 640× 480	155 pictures	2014 pictures	233 pictures	3022 pictures	259 pictures	3358 pictures

- The image storage capacity is for reference only. The actual image storage capacity may vary depending on the SD Memory Card and the subject.
- Only **1280** (1280×960) can be set for recorded pixels when  (Report) mode is set.

Movie/Sound

	Rec. time		Available Sound Recording Time	
	Built-in Memory	512 MB	Built-in Memory	512 MB
1280p (1280×720) : 15fps	34 sec.	7 min. 31 sec.	28 min. 53 sec.	6 hr. 14 min. 15 sec.
640p (640×480) : 30fps	34 sec.	7 min. 31 sec.		
640p (640×480) : 15fps	1 min. 8 sec.	14 min. 48 sec.		
320p (320×240) : 30fps	55 sec.	11 min. 59 sec.		
320p (320×240) : 15fps	1 min. 46 sec.	22 min. 53 sec.		

The recording time is for reference only. The actual recording time may vary depending on the SD Memory Card and the subject.

White Balance	Auto, Daylight, Shade, Tungsten Light, Fluorescent Light, Manual	
Lens	Focal Length	5.0 mm - 25.0 mm (approx. 28 mm - 140 mm in 35mm equivalent focal length)
	Aperture	F3.5 (W) - F5.5 (T)
	Lens Composition	11 elements in 9 groups (5 aspherical elements)
	Zoom Type	Electrically driven
Optical Zoom	5×	
Intelligent Zoom	Approx. 5.9× at 7M (3072×2304), Approx. 28.5× at 640 (640×480) (when combined with 5× optical zoom)	

Digital Zoom	Max. 5.7× (combines with 5× optical zoom to give zoom magnification equivalent to 28.5×)	
Motion Blur Reduction	Still	Hi-sensitivity shake reduction mode (Digital SR)
	Movie	Movie shake reduction (Movie SR)
Display	2.5"LCD, Wide viewing angle, approx. 230,000 dots, AR Coating	
Playback modes	Single-frame, 9-frame Index, Enlargement (max. 10×, scrollable), Face Close-up Playback, Folder Display, Calendar Display, Sound Playback, Histogram Display, Bright/Dark Portion Display, Deleting Selected Images, Digital SR, Slideshow, Resize, Cropping, Image&Sound Copy, Image Rotation, Digital Filter (Color Filter (11 kinds), Digital Filter, Brightness Filter), Movie Edit, Frame Composite, Red-eye Compensation, Voice Memo, Protect, DPOF, Image Recovery, Start-up Screen	
Focus Modes	Autofocus, Macro, 1cm Macro, Infinity, Pan Focus, Manual Focus	
Focus	Type	TTL contrast detection system by sensor 9-point autofocus (multiple/spot/automatic tracking AF changeable)
	Focus range (From lens face)	Standard : 0.5 m - ∞ (full zoom range) Macro : 0.1 m - 0.6 m (full zoom range) 1cm Macro : 0.01 m - 0.3 m (middle zoom position, Zoom step 2-4) * It is possible to switch to Pan Focus, Infinity and Manual Focus. * Face Recognition AF is available only while the camera recognizes the subject's face.
	Focus Lock	By half-pressing shutter release button
	Focus Lock	By half-pressing shutter release button
Exposure control	Metering System	Multi-segment metering, Center-weighted metering, Spot metering
	Exposure Compensation	±2 EV (can be set in 1/3 EV steps)
Face Priority	Recognition of max. 32 people's faces, Smile Capture, Blink Detection	
Scene modes	Auto Picture, Program, Night Scene, Movie, Underwater, Underwater Movie, Landscape, Flower, Portrait, Digital Wide, Surf & Snow, Digital SR (Blur Reduction), Kids, Pet, Half-length Portrait, Sport, Fireworks, Voice Recording, Night Scene Portrait, Text, Food, Digital Panorama, Frame Composite, Report, Green * Face Recognition AE is available only while the camera recognizes the subject's face.	
Digital Filters	B&W, Sepia, Red, Pink, Purple, Blue, Green, Yellow, Soft, Color extraction (Red, Green, Blue), Brightness, Fish-eye	
Movie	Continuous Recording Time	Approx. 1 second - until built-in memory or SD Memory Card is full (however, maximum size is limited to 2 GB)
Shutter Speed	1/1500 sec. - 1/4 sec., max. 4 sec. (Night Scene mode)	
Built-in Flash	Modes	Auto, Flash Off, Flash On, Auto + Red-eye, Flash On + Red-eye, Soft Flash
	Flash Range	Wide-angle: approx. 0.3 m - 3.9 m (approx. 0.98 ft - 13 ft) (Sensitivity: in Auto condition) Telephoto: approx. 0.4 m - 2.5 m (approx. 1.31 ft - 8.2 ft) (Sensitivity: in Auto condition)

Drive Modes	Single-frame, Self-timer (approx. 10 sec., approx. 2 sec.), Continuous Shooting, HS Cont. Shooting, Interval Shoot, Auto Bracket	
Self-timer	Electronic control type, control time: Approx. 10 sec., 2 sec.	
Time Function	World Time	75 cities (28 time zones)
	Clock Mode	Clock display by holding down OK/DISPLAY button while camera is turned off (approx. 10 sec.)
	Alarm	Alarm with simultaneous display of the Clock mode at specified time
Power Source	Rechargeable lithium-ion battery D-LI78, AC adapter kit (optional)	
Battery Life	Number of Recordable Images approx. 205 pictures	* Recording capacity shows approximate number of shots recorded during CIPA-compliant testing (with display on, flash used for 50% of the shots, and 23 degrees centigrade). Actual performance may vary according to operating conditions.
	Playback Time approx. 200 min.	* According to the result of in-house testing. Actual time may differ depending on usage conditions.
	Movie Recording Time approx. 75 min.	
	Sound Recording Time approx. 240 min.	
Interfaces	USB 2.0 (high-speed compatible) /PC/AV terminal	
Video Output	NTSC/PAL (monaural)	
PictBridge	Printer	PictBridge-compatible printer
	Print Modes	Print One, Print All, DPOF AUTOPRINT
	Paper Size	Card, L, 2L, Postcard, 100 mm×150 mm, 4"×6", 8"×10", Letter, 11"×17", A4, A3, printer setting
	Paper Type	★★★, ★★, ★, printer setting
	Quality	★★★, ★★, ★, printer setting
	Border Status	With/without, printer setting
Waterproof and Dustproof Function	Comply with JIS waterproof grade 8 and JIS dustproof grade 5 (IP58) Continuous underwater picture-taking possible for 2 hours at depth of 4 m.	
Dimensions	Approx. 98.0 (W) × 55.5 (H) × 24.5 (D) mm (excluding operating or protruding parts)	
Weight	Approx. 125 g (excluding battery and SD Memory Card)	
	Approx. 145 g (including battery and SD Memory Card)	
Accessories	Rechargeable lithium-ion battery, battery charger, AC plug cord, USB cable, AV cable, software (CD-ROM), strap, Operating Manual, PC Connection Manual, Quick Guide	

WARRANTY POLICY

All PENTAX cameras purchased through authorized bona fide photographic distribution channels are guaranteed against defects of material or workmanship for a period of twelve months from date of purchase. Service will be rendered, and defective parts will be replaced without cost to you within that period, provided the equipment does not show evidence of impact, sand or liquid damage, mishandling, tampering, battery or chemical corrosion, operation contrary to operating instructions, or modification by an unauthorized repair shop. The manufacturer or its authorized representatives shall not be liable for any repair or alterations except those made with its written consent and shall not be liable for damages from delay or loss of use or from other indirect or consequential damages of any kind, whether caused by defective material or workmanship or otherwise; and it is expressly agreed that the liability of the manufacturer or its representatives under all guarantees or warranties, whether expressed or implied, is strictly limited to the replacement of parts as hereinbefore provided. No refunds will be made on repairs by non-authorized PENTAX service facilities.

Procedure During 12-month Warranty Period

Any PENTAX which proves defective during the 12-month warranty period should be returned to the dealer from whom you purchased the equipment or to the manufacturer. If there is no representative of the manufacturer in your country, send the equipment to the manufacturer, with postage prepaid. In this case, it will take a considerable length of time before the equipment can be returned to you owing to the complicated customs procedures required. If the equipment is covered by warranty, repairs will be made and parts replaced free of charge, and the equipment will be returned to you upon completion of servicing. If the equipment is not covered by warranty, regular charges of the manufacturer or of its representatives will apply. Shipping charges are to be borne by the owner. If your PENTAX was purchased outside of the country where you wish to have it serviced during the warranty period, regular handling and servicing fees may be charged by the manufacturer's representatives in that country. Notwithstanding this, your PENTAX returned to the manufacturer will be serviced free of charge according to this procedure and warranty policy. In any case, however, shipping charges and customs clearance fees to be borne by the sender. To prove the date of your purchase when required, please keep the receipt or bills covering the purchase of your equipment for at least a year. Before sending your equipment for servicing, please make sure that you are sending it to the manufacturer's authorized representatives or their approved repair shops, unless you are sending it directly to the manufacturer. Always obtain a quotation for the service charge, and only after you accept the quoted service charge, instruct the service station to proceed with the servicing.

- This warranty policy does not affect the customer's statutory rights.
- The local warranty policies available from PENTAX distributors in some countries can supersede this warranty policy. Therefore, we recommend that you review the warranty card supplied with your product at the time of purchase, or contact the PENTAX distributor in your country for more information and to receive a copy of the warranty policy.



The CE Mark is a Directive conformity mark of the European Union.

For customers in USA

STATEMENT OF FCC COMPLIANCE

This device complies with Part 15 of the FCC Rules. Operation is subject to the following two conditions: (1) This device may not cause harmful interference, and (2) this device must accept any interference received, including interference that may cause undesired operation.

Changes or modifications not approved by the party responsible for compliance could void the user's authority to operate the equipment.

This equipment has been tested and found to comply with the limits for a Class B digital device, pursuant to part 15 of the FCC Rules.

These limits are designed to provide reasonable protection against harmful interference in a residential installation. This equipment generates, uses and can radiate frequency energy and, if not installed and used in accordance with the instructions, may cause harmful interference to radio communications. However, there is no guarantee that interference will not occur in a particular installation.

If this equipment does cause harmful interference to radio or television reception, which can be determined by turning the equipment off and on, the user is encouraged to try to correct the interference by one or more of the following measures:

- Reorient or relocate the receiving antenna.
Increase the separation between the equipment and receiver.
Connect the equipment into an outlet on a circuit different from that to which the receiver is connected.
- * Consult the dealer or an experienced radio/TV technician for help.

For customers in Canada

This Class B digital apparatus complies with Canadian ICES-003.

9

Pour les utilisateurs au Canada

Cet appareil numérique de la classe B est conforme à la norme NMB-003 du Canada.

FOR CALIFORNIA, U.S.A. ONLY

Perchlorate Material-special handling may apply. The lithium battery used in this camera contains perchlorate material, which may require special handling. See www.dtsc.ca.gov/hazardouswaste/perchlorate

Declaration of Conformity

According to 47CFR, Parts 2 and 15 for
Class B Personal Computers and Peripherals

We: PENTAX Imaging Company
A Division of PENTAX of America, Inc.

Located at: 600 12th Street, Suite 300
Golden, Colorado 80401 U.S.A.
Phone: 303-799-8000 FAX: 303-790-1131

Declare under sole responsibility that the product identified herein complies with 47CFR Parts 2 and 15 of the FCC rules as a Class B digital device. Each product marketed is identical to the representative unit tested and found to be compliant with the standards. Records maintained continue to reflect the equipment being produced can be expected to be within the variation accepted, due to quantity production and testing on the statistical basis as required by 47CFR §2.909. Operation is subject to the following two conditions: (1) This device may not cause harmful interference, and (2) This device must accept any interference received, including interference that may cause undesired operation. The above named party is responsible for ensuring that the equipment complies with the standards of 47CFR §15.101 to §15.109.

Product Name: PENTAX Digital Still Camera

Model Number: Optio W60

Contact person: Customer Service Manager

Date and Place: June, 2008, Colorado

Information on disposal for users



1. In the European Union

If your product is marked with this symbol, it means that used electrical/electronic products should not be mixed with general household waste. There exists a separate collection system for these products.

Used electric/electronic equipment must be treated separately and in accordance with legislation that requires proper treatment, recovery and recycling of these products. Following the implementation by member states, private households within the EU states may return their used electrical/electronic equipments to designated collection facilities free of charge*. In some countries your local retailer may also take back your old product free of charge if you purchase a similar new one.

*Please contact your local authority for further details.

By disposing of this product correctly you will help ensure that the waste undergoes the necessary treatment, recovery and recycling and thus prevent potential negative effects on the environment and human health which could otherwise arise due to inappropriate waste handling.

2. In other countries outside the EU

If you wish to discard this product, please contact your local authorities and ask for the correct method of disposal.

For Switzerland: Used electrical/electronic equipment can be returned free of charge to the dealer, even when you don't purchase a new product. Further collection facilities are listed on the home page of www.swico.ch or www.sens.ch.

Symbols

[Rec.Mode] menu	54
mode	12, 142
button	48, 50
button	47, 49
mode	12, 142
[Setting] menu	55
Green Mode	66
Green Button ..	48, 50, 121
Delete	46, 156
Tele	94
Wide	94
Magnify	145
Nine-image display	143
Self-timer	87
Continuous Shooting	88
Auto Picture	57, 64
Program	57, 65
Night Scene	57, 68
Movie	57
Voice Recording ...	58, 185
Frame Composite	71
Landscape	57
Flower	57
Portrait	57
Surf & Snow	57
Sport	57
Pet	57, 77
Digital SR (Blur Reduction)	57, 68
Digital SR (Camera Shake Reduction)	149
Kids	57
Food	58
Text	81
Digital Panorama	82
Digital Wide	84

Underwater	69
Report	58
Underwater Movie	69
Fireworks	68
Half-length Portrait	75
Night Scene Portrait	73

Numerics

1cm Macro	100
-----------	-----

A

















AC adapter	29
Adding sound (Voice Memo)	188
AE metering	110
Alarm	195
Auto + Red-eye	102
Auto Bracket	93
Auto AWB	108
Auto Power Off	205
Auto	102
Autofocus conditions	115
AV equipment	154

B

B&W	135
Basic mode	66
Battery level indicator	28
Blink Detection	61
Bright portions	22
Built-in memory display	142

C

Camera shake	95, 98
Capture Mode Palette	56
Center-weighted metering	110
Changing volume	187, 191

Charging a battery	25	Flash On 	102
Checking the Memory		Fluores. Light 	108
Card	37	Focus	116
Color Mode	135	Focus Limiter	116
Computer	201	Focus Mode	100
Connecting to a printer	180	Focusing	100
Continuous Shooting 	88	Focusing Area	115
Contrast	126	Format	190
Copy	167	Four-way controller	48, 50
Cropping	166	Frame Composite	71, 173
D		Frame Rate	35
Dark portions	22	G	
Date and time	41, 193	Green Button 	48, 50, 121
Date Imprint	127	Green Mode 	66
Daylight 	108	Guide display	207
Daylight saving time	41	H	
Default setting	39, 213	Histogram	99
Delete 	46, 156	Hometown	41
Deleting sounds	157	HS Cont. Shooting 	88
Digital Filter	169	I	
Digital Panorama 	82	Infinity 	100
Digital SR (Camera Shake Reduction)	149	Installing a battery	26
Digital SR (Blur Reduction)	57, 68	Instant Review	44, 120
Digital Wide	84	Interval	117, 137
Digital Zoom	96	Interval Movie 	137
Display brightness	203	Interval Shoot 	90, 117
Dividing movies	176	L	
DPOF printing	184	Language	39, 199
DPOF settings	177	M	
F		Macro 	100
Face close-up playback ...	146	Magnify 	145
Face Recognition AE	59	Manual Focus MF	100
Face Recognition AF	59	Manual 	108
File No.	128	Memory	128
Fireworks	68	MENU button	47, 50
Flash Off 	102		
Flash On + Red-eye 	102		

Movie SR (Movie Shake
Reduction) Function 136
Multi-segment
metering  110

N

Nine-image display  143
NTSC 202
Number of pixels 104
Number of Recordable
Images 35
Number of Shot 117

O

OK/DISPLAY button .. 48, 50
Optional accessory 222

P

PAL 202
Pan Focus **PF** 100
Panoramic Pictures 82
Photo processing lab 177
PictBridge 180
Playback
..... 45, 142, 153, 187, 189
Playback Mode 38
Playback Mode Palette 62
Playing back movies 153
Playing back sounds 187
Portrait Mode 73
Power Saving 204
Power switch 37, 47, 49
Press fully
(shutter release button) 44
Press halfway
(shutter release button) 44
Printing 180
Protect  162

Q





Quality Level 34, 107

Quick Zoom 206

R

Recorded Pixels
..... 34, 35, 104, 133
Recording movies 130
Recording sounds 185
Recovering images 161
Red-eye Compensation ... 172
Red-eye reduction
 102, 103
Resetting settings 208
Resize 164
Rotating 46

S

Saturation 125
Saving as still picture
(movie) 175
Saving settings 128
SD Memory Card 31
Select time 198
Self-timer  87
Sensitivity 112
Sepia 135
Setting the exposure 97
Shade  108
Sharpness 124
Shooting information
..... 98, 148
Shooting Mode 56
Shutter release
button 44, 47, 49
Slideshow 151
Soft Flash ^{SOFT}  102
Sound settings 191
Sound types 191
Spot AE metering  110
Standard **AF** 100
Start Delay 117, 137
Start-up screen 209

Strap 24

T

Taking pictures

underwater 69

Total Time 137

Tungsten Light ☼ 108

TV 154

U

Underwater 69

USB connection mode 201

V

Video output format 202

Voice Memo 188

W

Waterproof and Dustproof
..... 5, 69

White Balance 108

World Time 197

Z

Zoom button 47, 49

Zoom ▲ ▲▲▲ 94

Memo

HOYA CORPORATION

PENTAX Imaging Systems Division

2-36-9, Maeno-cho, Itabashi-ku, Tokyo 174-8639, JAPAN
(<http://www.pentax.jp>)

**PENTAX Europe GmbH
(European Headquarters)**

Julius-Vosseler-Strasse 104, 22527 Hamburg, GERMANY
(HQ - <http://www.pentaxeurope.com>)
(Germany - <http://www.pentax.de>)

PENTAX U.K. Limited

PENTAX House, Heron Drive, Langley, Slough, Berks
SL3 8PN, U.K.
(<http://www.pentax.uk>)

PENTAX France S.A.S.

112 Quai de Bezons, B.P. 204, 95106 Argenteuil
Cedex, France
(<http://www.pentax.fr>)

PENTAX (Schweiz) AG

Widenholzstrasse 1, 8304 Wallisellen, Postfach 367,
8305 Dietlikon, SWITZERLAND
(<http://www.pentax.ch>)

PENTAX Italia S.r.l.

Via Dione Cassio 15, 20138 Milano, ITALY
(<http://www.pentaxitalia.it>)

PENTAX Europe GmbH (Tyskland) Filial Sverige

Box 650, 75127 Uppsala, SWEDEN
(<http://www.pentax.se>)

PENTAX Imaging Company

A Division of PENTAX of America, Inc.

(Headquarters)
600 12th Street, Suite 300 Golden, Colorado 80401, U.S.A.
(PENTAX Service Department)
12000 Zuni Street, Suite 100B Westminster, Colorado
80234, U.S.A. (<http://www.pentaximaging.com>)

PENTAX Canada Inc.

1770 Argenta Road Mississauga, Ontario L5N 3S7, CANADA
(<http://www.pentax.ca>)

**PENTAX Trading
(SHANGHAI) Limited**

23D, Jun Yao International Plaza, 789 Zhaojiabang
Road, Xu Hui District, Shanghai, 200032 CHINA
(<http://www.pentax.com.cn>)

<http://www.pentax.jp/english>

Specifications and external dimensions are subject to change without notice.