

DIGITAL STILL CAMERA

EI-C90

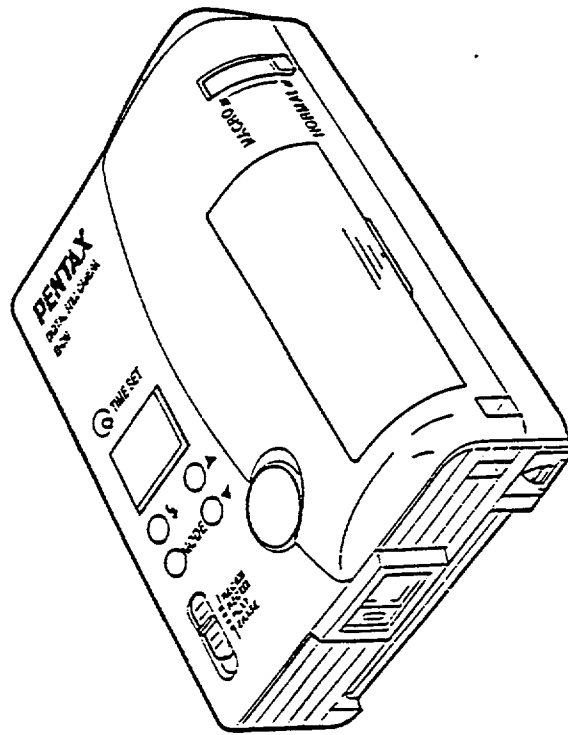

Thank you very much for purchasing the PENTAX DIGITAL STILL CAMERA EI-C90. Before using your camera, please read this operating manual carefully to understand the proper use of the camera.

- Illustrations shown herein may differ from the camera's actual appearance.

FOR SAFE USE OF YOUR DIGITAL CAMERA

Although we have carefully designed this camera for safe operation, please be sure to follow precautions given in this page.

- Warning** This mark indicates precautions that, if not followed, could result in serious injury to the operator.
- Caution** This mark indicates precautions that, if not followed, could result in minor or medium injury to the operator or damage to the equipment.
- Warning**
 - The electric circuits inside the camera contain high voltage working parts. Never attempt to disassemble the camera yourself.
 - Wrapping the strap around your neck is dangerous. Make sure that small children do not get the strap caught around their neck.
 - Be sure to store batteries out of the reach of children. Seek medical assistance immediately if accidentally swallowed.
 - When connecting the camera to an AC outlet, use only the exclusively designed Pentax AC Adapter. Use of any other AC Adapter may cause a fire or electric shock.

- CAUTION**
 - Never try to disassemble, short or recharge the battery. Also, do not dispose of the battery in fire, as it may explode.
 - Remove the battery from the camera immediately if it becomes hot or begins to smoke. Be careful not to burn yourself during removal.

or customers in the USA
STATEMENT OF FCC COMPLIANCE

This device complies with Part 15 of the FCC rules. Operation is subject to the following two conditions: (1) This device may not cause harmful interference, and (2) this device must accept any interference received, including interference that may cause undesired operation.

Changes or modifications not approved by the party responsible for compliance could void the user's authority to operate the equipment.

This equipment has been tested and found to comply with the limits for a Class B digital device, pursuant to part 15 of the FCC Rules. These limits are designed to provide reasonable protection against harmful interference in a residential installation. This equipment generates, uses and can radiate frequency energy and, if not installed and used in accordance with the instructions, may cause harmful interference to radio communications. However, there is no guarantee that interference will not occur in a particular installation. If this equipment does cause harmful interference to radio or television reception, which can be determined by turning the equipment off and on, the user is encouraged to try to correct the interference by one or more of the following measures:

- Reorient or relocate the receiving antenna.
- Increase the separation between the equipment and receiver.
- Connect the equipment into an outlet on a circuit different from that to which the receiver is connected.
- Consult the dealer or an experienced radio/TV technician for help.

For customers in Canada
This Class B digital apparatus meets all requirements of the Canadian Interference Causing Equipment Regulations.

Do not use the camera where it may come in contact with rain, water or any other liquid, because the camera is not weather, water resistant. Should the camera get wet from rain, splashing water, or any other liquid, wipe it off immediately with a dry soft cloth.

Be careful not to subject the camera to strong vibrations, shock or pressure. Use a cushion to protect the camera when carrying it in a motorcycle, car, boat, etc. Avoid leaving the camera for an extended period in places where the humidity and temperature are very high, such as in a car.

Never use solvents such as paint thinner, alcohol or benzene to clean the camera. Do not store the camera in a closet with mothballs or in a case where chemicals are handled. Store it in a place with good air circulation to prevent fungus growth. Use a blower and lens brush to remove dust accumulated on the lens or the viewfinder.

If the camera has not been used for an extended period, or is being prepared for an important event, it is recommended that you have the camera inspected or test shoot with it.

The temperature range at which this camera functions properly is 40°C to 0°C (104°F to 32°F).

Condensation on the interior or the exterior of the camera may be extremely harmful to the camera mechanism as it may cause rust. Furthermore, if the camera is taken from warm temperature to a subfreezing one or vice versa, the formation of icicles may cause damage. In such a case, put the camera into a case or plastic bag so that any changes in temperature difference is minimized. Do not remove it from the bag until temperature has stabilized.

Dirt, mud, sand, moisture, toxic gas, water, salt water, etc., penetrating the inside of the camera may cause damage or render it inoperable. Damage of any kind will not be prepared under the term of the warranty and charges may be assessed. Therefore, handle the camera with great care.

- 1 Shutter Release Button (p.14)
- 2 Slide Mode Switch (p.14, 25, 30.)
- 3 Mode Button
- 4 Flash Mode Button (p.16, 17)
- 5 LCD Information Panel (p.41)
- 6 Date Adjustment Button (p.20)
- 7 Up-Down Button
- 8 PC Card Slot (p.35)
- 9 Exposure/Built-in flash Information Lamp (p.14, 15,19)
- 10 Viewfinder eyepiece
- 11 PC Card Eject Button (p.35)
- 12 Strap lug (p.9)
- 13 Battery Chamber Cover (p.10)
- 14 Macro Adjustment Lever (p.19)

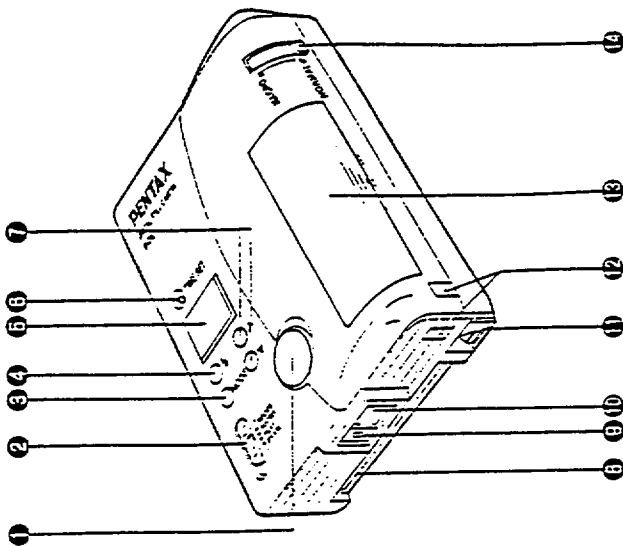

- 15 Lens
- 16 Viewfinder Window
- 17 Flash Receiving Window (p.13)
- 18 Built-in Flash
- 19 Digital Interface Terminal (p.7)
- 20 Tripod Socket
- 21 Self-timer Lamp (p.14,18)
- 22 Power Switch (p.12)
- 23 Video Output Terminal (p.25)
- 24 DC Input Terminal (p.36)
- 25 Electrical contacts for LCD monitor

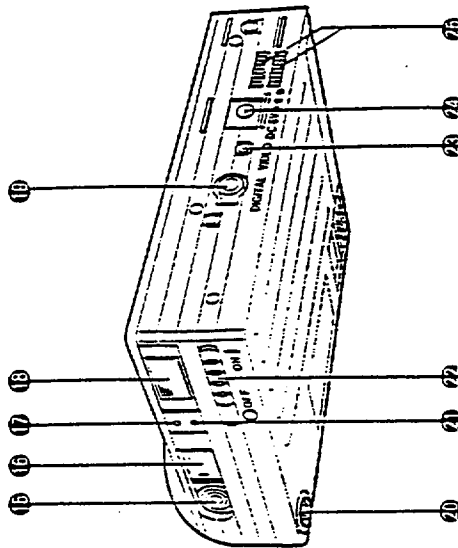

If you use the terminal 19, 23, or 24 or install the LCD monitor to the camera, remove the protection cover. If you do not install the LCD monitor to the camera, attach the supplied small cap to 25 to protect the contacts against any damage.

OUTLINE OF BASIC OPERATIONS

Preparation

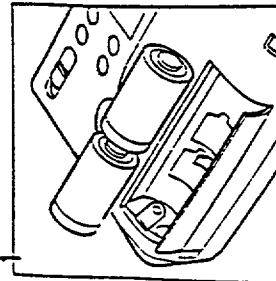

1 Insert the batteries (two CR2 or equivalent) into the camera. (When using an optional AC Adapter, connect the AC Adapter to the camera body first, then plug it in to an AC outlet.)

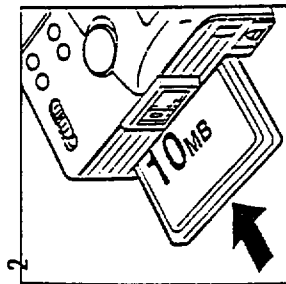

2 Insert the PC card. (If the built-in flash memory is used, the PC card is not required.)

Recording images

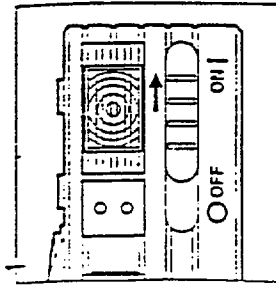

1 Set the Power Switch to the [ON] position.

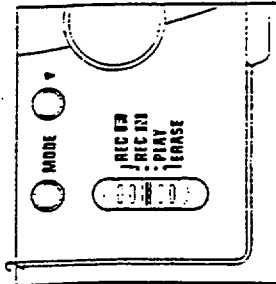

2 Set the Slide Mode Switch to the [REC N] position.

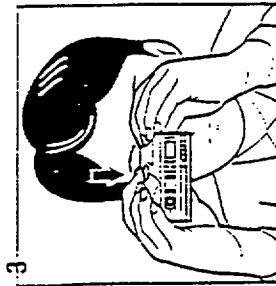

3 Press the Shutter Release Button.

Playing back images

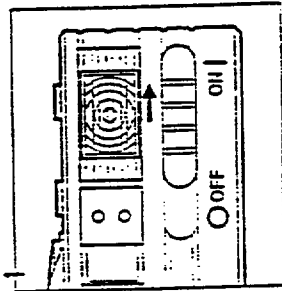

1 Set the Power Switch to the [ON] position.

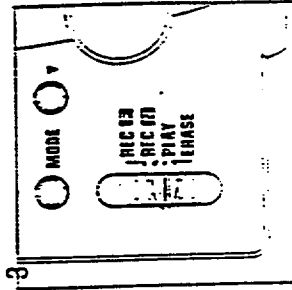

3 Set the Slide Mode Switch to the [PLAY] position.

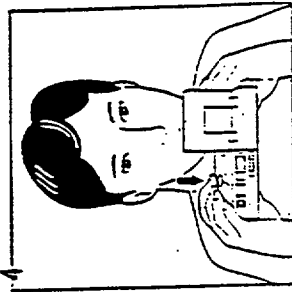

4 Press the Shutter Release Button to display the image.

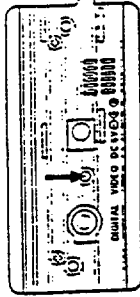

2

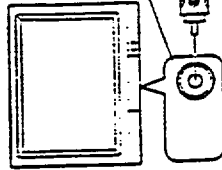

Image Input Terminal

2 Connect the camera to an NTSC-standard television with a video cable. (An optional LCD Color Monitor EI-L90 can also be used.)

Transfer the recorded images to a personal computer

Use of the Interface Cable Kit is required.

1 Connect the camera and a personal computer as illustrated.

2 Connect an NTSC-standard television or LCD monitor to the camera.

3 Set the Slide Mode Switch to the [PLAY] position.

4 Press the Mode Button until [<:::] and [>] appear on the LCD panel.

5 Press the Shutter Release Button halfway down to stop [<:::] blinking. It is now ready to transfer the recorded images to a personal computer.

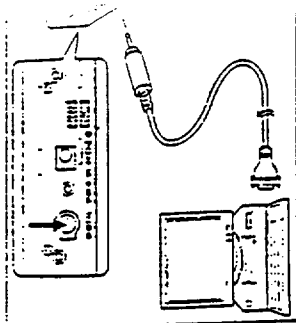

• When the batteries of the LCD monitor are exhausted while transmitting the recorded data to a personal computer, the recorded data might be damaged. Use of an optional AC Adapter is recommended.

TABLE OF CONTENTS

FOR SAFE USE OF YOUR CAMERA	3
PRECAUTIONS	4
NAMES OF WORKING PARTS	5
OUTLINE OF BASIC OPERATIONS	6
CONNECTING A PERSONAL COMPUTER	7
STRAP ATTACHMENT	9
INSTALLING THE BATTERIES	10
BATTERY EXHAUSTION WARNING	11
TURNING ON THE POWER	12
HOW TO HOLD THE CAMERA	13
RECORDING	14
Selecting the Recording Quality	14
DAYLIGHT-SYNC SHOOTING	16
MAKING PICTURES AT A SLOW SHUTTER SPEED	17
SLF-TIMER SHOOTING	18
MACRO (Close-up) SHOOTING	19
CORDING DATE AND TIME	20
Correcting the date and time	20
EXPOSURE COMPENSATION	22
MOVING PICTURES WHILE VIEWING THE IMAGE ON THE LCD MONITOR	
TV MONITOR	23
ERASING BACK IMAGES	25
CONTINUOUS - PLAYBACK MODE	27
MULTI-IMAGE PLAYBACK	28
1-IMAGE DISPLAY	28
9-IMAGE DISPLAY	29
ERASING IMAGES	30
SINGLE-IMAGE EASING	30
ERASING ALL IMAGES	31
ERASING WHILE VIEWING THE IMAGES ON THE LCD MONITOR	32
INITIALIZATION	33
CORDING TO THE PC CARD	34
INSERTING THE PC CARD	35
CONNECTING TO AN AC ADAPTER	36
COPYING IMAGES	37
Copying the selected image in the built-in flash memory to the PC card	37
Copying all images in the built-in flash memory to the PC card	38
DOUBLE SHOOTING	40
SPECIFICATIONS	41
LCD PANEL	42
WARRANTY POLICY	43

STRAP ATTACHMENT

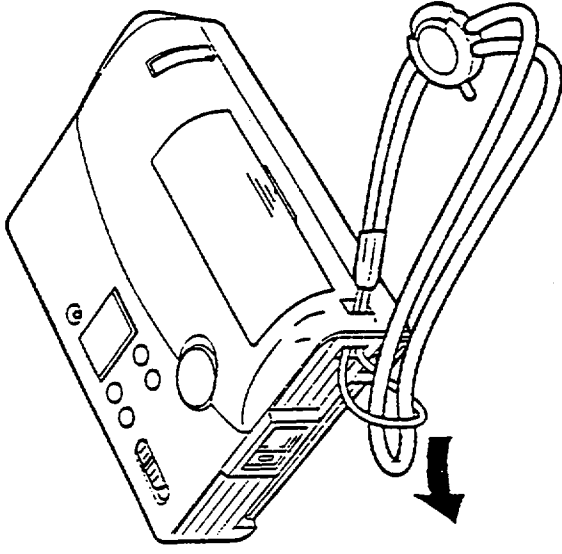

Fit the strap on the camera as illustrated.

Icon indications used in this manual.

Operation direction	←
Automatic operation	↔
Attention	⊙

INSTALLING THE BATTERIES

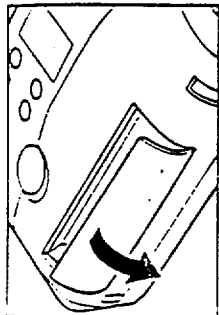

1 Open the Battery Chamber Cover by pushing the illustrated part.

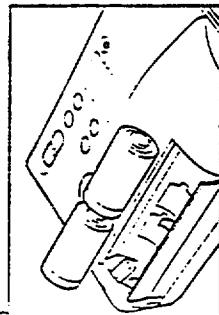

2 Install two lithium batteries (CR2 or equivalent) with the plus/minus (+/-) side matching the indications in the Battery Chamber.

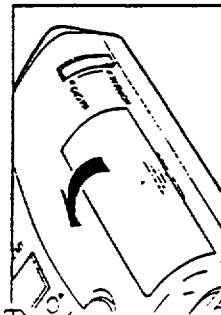

3 Close the Battery Chamber Cover.

Keep a spare battery on hand for replacement convenience when shooting outdoors, while traveling, or shooting in cold weather. When the camera is used for a long period of time, use of the optional AC Adapter is recommended.

After the batteries are replaced or removed, the date is set to 1997 1 1 and time is set to 0 00. See page 20 for correcting the date and time.

CAUTION

Danger of explosion if the battery is incorrectly replaced.

Replace only with the battery as specified below.

DURACELL DLCR2

PANASONIC CR2



SANYO CR2

If the proper battery is not available, contact your local Pentax distributor or a Pentax service center.

Dispose of used batteries according to the manufacturer's instructions.

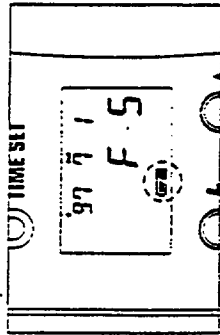
BATTERY EXHAUSTION WARNING



[] Full-Battery indicator: Power is sufficient for all camera operations.
[] Blinking Low-Battery warning: Replace the battery as soon as possible.
[] Blinking Low-Battery warning: No operation can be performed.

- Battery performance may temporarily deteriorate in low temperatures, but will recover in normal temperature.
- With the LCD monitor attached to the camera, the low battery warning on the camera's LCD panel will indicate when the monitor's batteries are exhausted. Replace the batteries in the LCD monitor.

Battery life

Approximately 700 frames (without using the built-in flash)
Approximately 20 minutes (when playing back continuously)

CR2 batteries were used under Pentax testing conditions. The battery life may vary depending on usage of flash, recording, playback and external conditions such as temperature and freshness of the battery.

TURNING ON THE POWER

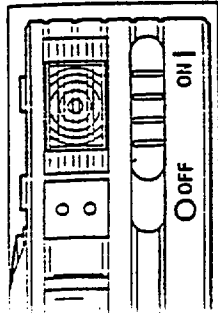

Set the Power Switch to the [ON] position. To turn off the power, set the Power Switch to the [OFF] position.

- When the Power Switch is set to the ON position, the Lens Protector is opened. If the power is on and left unused for over 1 minute, the power is automatically turned off. All indicators on the LCD panel will disappear. This function does not operate if the AC Adapter is connected to the DC Input Terminal of the camera. This automatic power off function can be canceled. See page 26 for more details.
- When the camera is not used, be sure to turn the camera OFF as a slight amount of battery consumption remains when the power is automatically turned off.
- If the Power Switch of the camera is set to the OFF position and the Power Switch of the LCD monitor is left to the ON position; the Power Lamp of the LCD monitor is turned OFF. However, a slight drain on the LCD Monitor batteries remains if Monitor is left ON.
- When [] appears on the LCD panel, the battery is nearly exhausted. See page 10 for replacing the batteries.
- Install two lithium batteries (CR-2 or the equivalent).
- After the batteries are replaced or removed, correct the date and time.
- Battery performance may temporarily deteriorate in low temperatures, but it will recover in normal temperature.
- Keep spare batteries on hand for replacement convenience when using outdoors, while traveling or shooting in cold weather.

HOW TO HOLD THE CAMERA

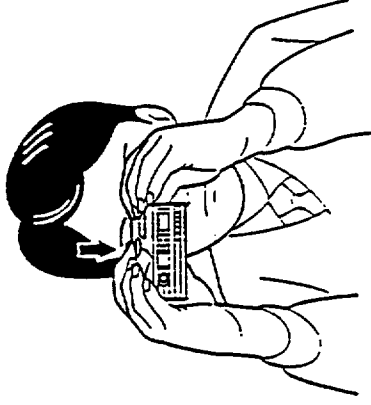

- Hold the camera as still as possible with both hands. Hold the camera against your face, and look through the viewfinder. Gently press the shutter button.
- Make sure not to obstruct the lens, flash receiving window, or the Built-in Flash with your fingers, hair or other object.

RECORDING

The camera has two levels of recording qualities. REC N is the Normal recording quality and REC F is the Fine recording quality which gives priority to picture quality.

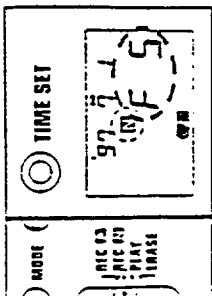

Selecting the Recording Quality

- 1 Set the Slide Mode Switch to the [REC F] or [REC N] position.
 - When the switch is set to [REC F], [F] appears on the LCD panel. When the switch is set to [REC N], [N] appears on the LCD panel.
 - The number of remaining frames such as [F1] or [F5] appears on the LCD panel. If the PC card is installed, the number of remaining frames appear without the letter [F].

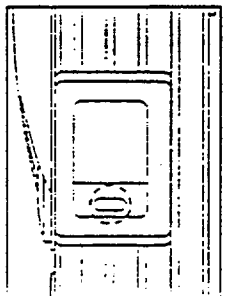

- 2 Press the Shutter Release Button halfway down. After confirming the Green Lamp next to the viewfinder lights up, press the Shutter Release Button fully for recording.

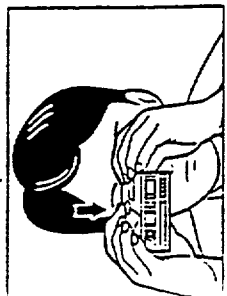

With each picture you take, the number of remaining frames on the LCD panel decreases by one. If you reset the power or change the position of the Slide Mode switch, the number of remaining frame will be recalculated and it may possible to increase the remaining number of frames. When the picture is recorded on the last remaining frame with the Normal recording Mode set, the recording time may take longer than usual or the picture quality may be deteriorated.

Press the Shutter Release Button halfway down. If the subject is too bright or too dark, the Green Lamp next to the viewfinder will blink. If the subject is too bright, select a darker subject. Use the built-in flash if the subject is too dark. The picture can be taken even if the Green Lamp is blinking, but the picture will not be exposed properly.

- When the Shutter Release Button is pressed fully, the Self-timer Lamp momentarily lights up, indicating that the picture has been recorded.
- There are two levels of recording qualities in this camera. The memory capacity of the REC F is 1.3MB and the memory capacity of the REC N is approx 100KB. To obtain the high quality image, set the Slide Mode Switch to the [REC F] position.
 - The shooting range is from 1m (3.3 ft) to infinity.
 - The [O] indicators appear on the LCD panel and disappear one by one while recording the image. Do not set the power switch to the OFF position, remove the batteries or the PC card while recording the image. Doing so may corrupt image data already stored in the camera's built-in flash memory or the PC card.
 - To determine the maximum number of storage frames when the built-in flash memory or PC card is used, see page 34.

Automatic Flash Function

This camera will automatically discharge the flash when shooting in low light. This function is automatically set when the power is turned on or the Slide Mode Switch is set to the [REC N] or [REC F] position.

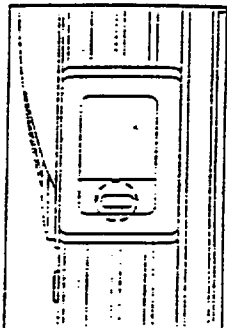

The Built-in Flash is ready to discharge if the Red Lamp lights up.

- The Red Lamp blinks while the flash is being charged.
- The flash effective range is from 1m (3.3 ft) - 3m (9.8 ft).

Auto-White balance

To take a picture with natural color balance, the white balance is automatically adjusted each time you press the Shutter Release Button halfway or fully down. The white balance cannot be adjusted when the subject has a small white-colored area.

DAYLIGHT-SYNC SHOOTING

In this mode, the flash will discharge in both dark and bright conditions. When taking pictures of people with a backlight situation, the front of the subject may be cast in shadow.

In such a case, use the Daylight-Sync Shooting Mode (Flash-ON mode) within the flash effective range. This will ensure that a picture is well exposed without any shadow.

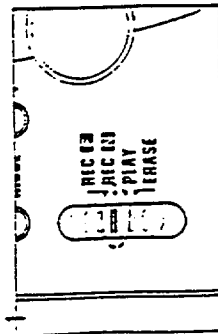

1 Set the Slide Mode Switch to the [REC F] or [REC N] position.

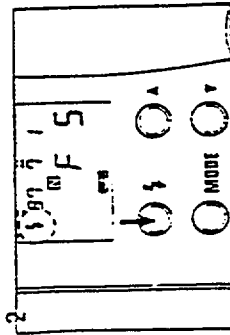

2 Press the Flash Mode Button until [] appears on the LCD panel.

Make sure that you are within the flash-effective range even when you use the Built-in Flash as a fill-in flash in daylight.

The flash effective range is from 1m (3.3 ft) to 3m (9.8 ft).

TAKING PICTURES WITH A SLOW SHUTTER SPEED

In this mode, the flash does not discharge and a picture is taken at a slow shutter speed. Use it in places where flash photography is prohibited, such as in theaters and museums. Furthermore, this mode is also useful for a natural existing light effect in low ambient photography.

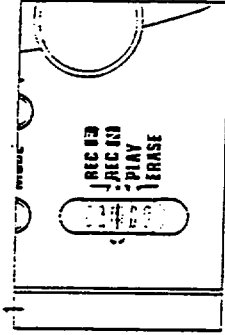

1 Set the Slide Mode Switch to the [REC F] or [REC N] position.

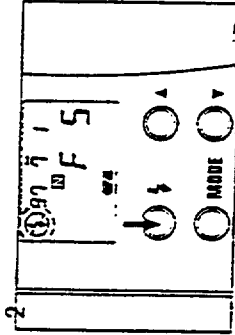



2 Press the Flash Mode Button until [] appears on the LCD panel.

When shooting in low light, the shutter speed gets slower, and camera shake is likely to blur your pictures. Use of the Built-in Flash is recommended.

SELF-TIMER SHOOTING

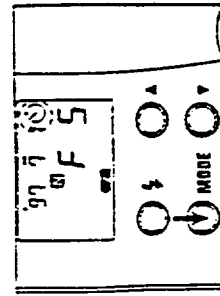
This mode is useful for taking group shots that includes the photographer.



- 1 Set the Slide Mode Switch to the [REC F] or [REC N] position and press the Mode Button until [] appears on the LCD panel.

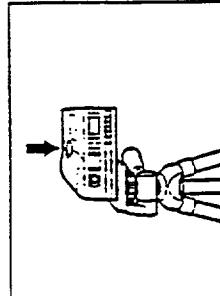

- 2 Compose the subject within the picture frame. Press the Shutter Release Button fully.

The picture will be taken in about 10 seconds. When the Self-timer is working, the Self-Timer indicator [] blinks on the LCD panel and the Self-Timer Lamp lights up and blinks 3 seconds before the picture is taken.

To cancel the self-timer at any time after its been activated, press the mode button.

Use of a tripod is recommended.

When you want to use the flash with the self-timer, ensure that the Red lamp is lit indicating the flash has been charged before operating the self-timer.

MACRO (Close-up) SHOOTING

Use the Macro Shooting Mode to take pictures of small subjects at a very close distance.

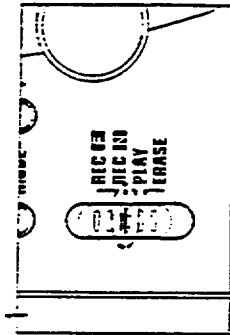

- 1 Set the Slide Mode Switch to the [REC F] or [REC N] position.

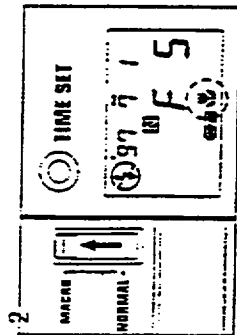

- 2 Turn the Macro Adjustment Lever to the MACRO side. [] and [] appear on the LCD panel.

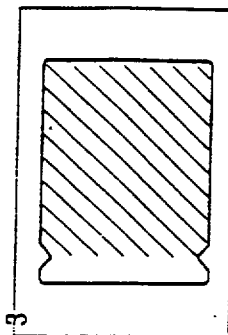

- 3 Compose the scene within the slant lines. Confirm that the Orange Lamp lights up and then press the Shutter Release Button fully.

The minimum shooting distance varies from 2cm (0.8 in) to 1m (3.3 ft) depending on where the Macro Adjustment Lever is set. Set the Macro Adjustment Lever to your desired position.

- If the Macro Adjustment Lever is set to the [MACRO] position, the image in the viewfinder is quite different from the picture focused through the lens. To confirm the focus in the Macro Shooting Mode, connecting an optional LCD monitor or a TV monitor to the camera is recommended.
- In the Macro Shooting Mode, the flash will not be discharged.
- There is a click between the NORMAL and MACRO, if the Macro Adjustment Lever is set to the click [], the focus is fixed at 23.5cm (0.77 ft).
- The [O] indicators appear on the LCD panel and disappear one by one while recording the image. Do not set the Power Switch to the [OFF] position, remove the batteries or the PC card while recording the image. Doing so may corrupt image data already stored in the camera's built-in memory or the PC card.

Notes

- 1 Press the Shutter Release Button halfway down. If the subject is too bright or too dark, the Orange Lamp next to the viewfinder will blink. If the subject is too bright, select a darker subject.
- 2 The picture can be taken even if the Orange Lamp is blinking. But the picture will not be exposed properly.

RECORDING THE DATE AND TIME

is camera has an automatic calendar through the year 2079. However, you should set the correct date and time when you first use your camera or if you travel to a different time zone.

Switching the Date Mode

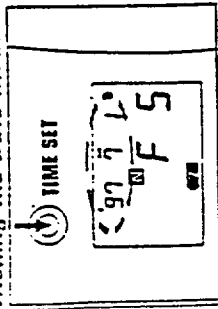

Press the Date Adjustment Button with your finger, the Date Mode on the LCD panel switches as shown in the chart.

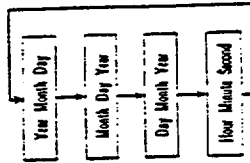

The date cannot be switched if the power is turned off. The date and time are recorded with each picture you take. The recorded date and time can be seen when you display the image on the LCD monitor.

"M" on the LCD panel indicates "Month".
 "..." on the LCD panel indicates "Year".

Correcting the date and time

1 Keep pressing the [TIME SET] button for 3 seconds until "Year" digits start blinking.

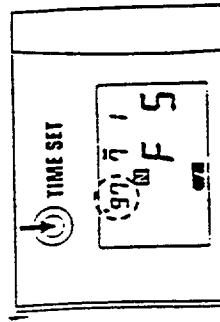

2 Each time the [TIME SET button] is pressed, the blinking digits change in the following manner.

Year → Month → Day → Hour → Minute → Second
 Stop pressing the button when desired digits appear.

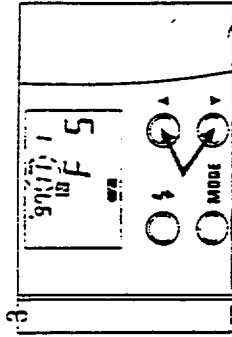
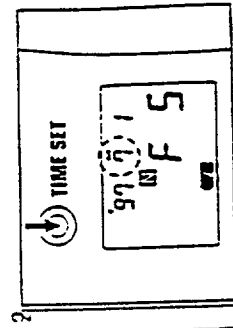

3 Press the ▲ (UP) or ▼ (DOWN) button, when you wish to change the blinking digits. The digits increase by one each time the ▲ button is pressed and the digits decrease by one each time the ▼ button is pressed. Keep pressing the button for one second will change the digits continuously.

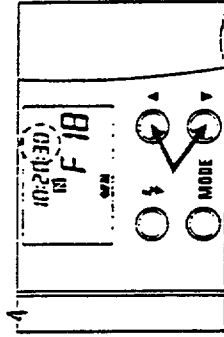

4 When the second digits are blinking, pressing the ▲ button to set the second digits to [30] and the ▼ button set the second digits to [00].

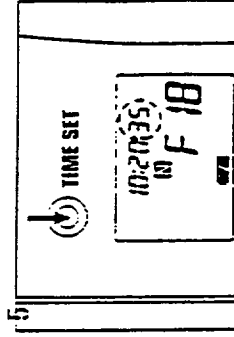

5 After the second digits have been adjusted, press the [TIME SET] button to stop blinking.

- The data cannot be corrected when the power is turned OFF.
- After the battery is replaced or removed, be sure to correct the date and time.
- The date and time are always recorded at the same time.

EXPOSURE COMPENSATION

The exposure compensation allows you to deliberately overexposure (brighten) or underexposure (darken) a subject or compensate for difficult lighting condition which may fool the camera's light sensor.

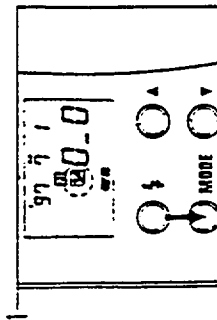

- 1 Set the Slide Mode Switch to the [REC F] or [REC N] position.
Press the [MODE] button until [0.0] appears on the LCD panel.

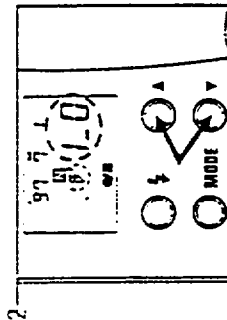

- 2 Press the [▲] or [▼] button to set your desired compensation value.
Pressing the [▲] button increases (overexposure) the compensation value and [▼] button decreases (underexposure) compensation value.
[1.5] or [0] appears on the LCD panel.

- The exposure compensation value of 1.5EV indicates [1.5] on the LCD panel.
- Exposure compensation range is -2EV to +2EV in 0.5EV stops.
- The exposure compensation value is set to [0] when the Slide Mode Switch is set to any position other than [REC] or when the power is turned off.

TAKING A PICTURE WHILE VIEWING THE IMAGE ON THE LCD MONITOR OR TV MONITOR

To take a picture while viewing the image on the monitor, connect an optional LCD monitor (EI-L90) to the camera or connect the supplied video cable to a TV monitor (NTSC only).

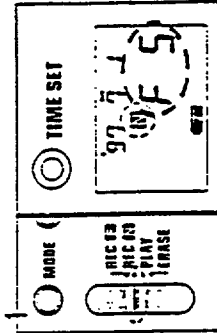

- 1 Connect the LCD monitor (EI-L90) to the camera or connect the video cable to a TV monitor.
Set the Slide Mode Switch to the [REC N] or [REC F] position.

- [N] appears when the Slide Mode Switch is set to [REC N], and [F] appears when it is set to [REC F].

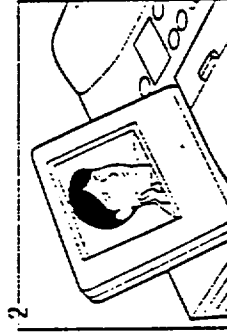

- 2 When the Shutter Release Button is pressed halfway down, the image is displayed on the LCD monitor or TV monitor.

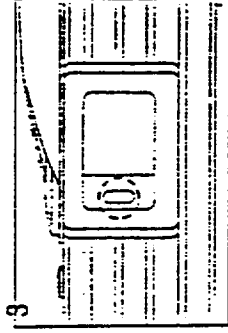

- 3 Ensure that the Green Lamp lights up and then press the Shutter Release Button fully down. In the Macro Shooting Mode, the Orange Lamp lights up.

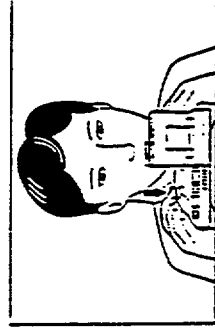

PLAYING BACK IMAGES

- Read the operating manual of the LCD monitor (EI-L90) for connecting/disconnecting the LCD monitor (EI-L90) and the camera.
- When the Shutter Release Button is pressed halfway down, the number of remaining frames and [REC] appear on the monitor for 3 seconds.
- See page 25 for connecting the video cable between the Video Output Terminal of the camera and a TV monitor.
- When the Shutter Release Button is pressed fully, the [O] indicators appear on the LCD panel and disappear one by one while picture is recording. Do not set the power switch to the [OFF] position, remove the batteries or the PC card while recording the image. Doing so may corrupt picture data already stored in the built-in flash memory or the PC card.
- After a picture is taken, the image on the LCD monitor goes off. To view the image, press the Shutter Release Button halfway down.
- If the power is on and left unused for over 30 seconds, the image on the LCD Monitor goes off automatically. (This automatic function can be canceled. See page 26 for more details.) However, if the AC Adapter is connected to the DC Input Terminal of the camera, the images can be viewed on an NTSC TV monitor without interruption.
- Taking a picture while viewing the monitor, you can confirm the focus and exposure conditions even if the exposure compensation is adjusted.
- The Self-timer Lamp lights up momentarily when the Shutter Release Button is pressed fully.
- There are two levels of recording qualities in this camera. The memory capacity of the REC F is 1.3MB and the memory capacity of the REC N is 100KB. To obtain the high quality of image, set the Slide Mode Switch to the [REC F] position.
- The shooting distance is from 1m (3.3 ft) to infinity.

To display images, connect an optional color LCD monitor (EI-L90) to the camera or connect the supplied video cable between the Video Output Terminal of the camera and a TV monitor. (NTSC only).

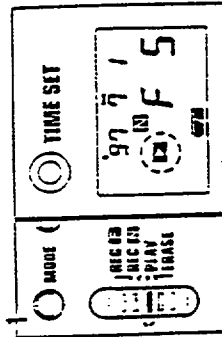
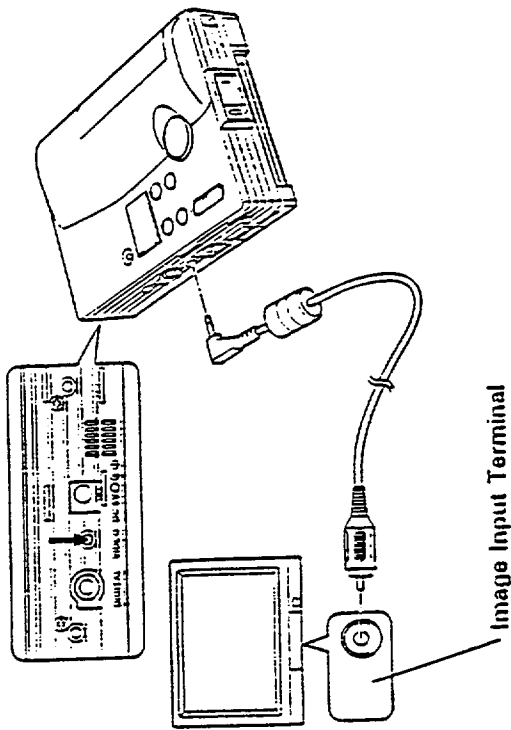

- 1 Set the Slide Mode Switch to the [PLAY] position. [] blinks on the LCD panel indicator; the camera is set in the Playback Mode.

CONTINUOUS PLAYBACK MODE

2 The playback frame number such as F1 and F5 appear on the LCD panel. If the PC card is inserted, the frame number appear without the letter F. Press the ▲ or ▼ button until your desired frame number appears on the LCD panel.

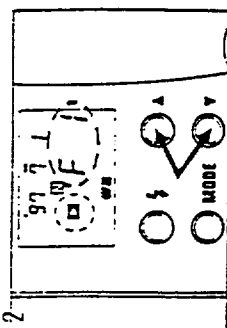

3 Press the Shutter Release Button halfway down. Your desired picture is displayed on the LCD monitor or TV monitor.

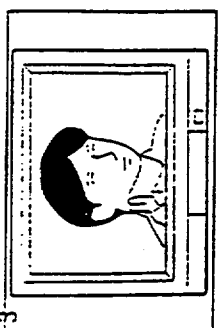

- In the Playback Mode, if the ▲ button is pressed, you can view the next image and the ▼ button is pressed, you can view the previous image.
- The image on the LCD Monitor automatically goes off if the camera is left unused for over 30 seconds. (This automatic function can be canceled.) However, if the AC Adapter is connected to the DC Input Terminal of the camera, the images can be viewed on an NTSC TV monitor without interruption.
- In the Playback Mode, pressing the Shutter Release Button repeatedly changes the image display in the following order:

Image is displayed with Date, Time, Number of Remaining Frames and [PLAY].

Image goes off

Image is displayed without information

Image goes off

An image on the LCD monitor goes off when the camera is unused for over 30 seconds and the power is turned off when the camera is unused for over 1 minute. These functions can be canceled in the following procedures.

- 1 Set the Slide Mode Switch to the [PLAY] position and then depress the shutter release button halfway down to delete the image on the LCD monitor.
- 2 Keep pressing the Shutter Release Button for 10 seconds until [] starts blinking. The blinking [] indicates that the automatic function has been canceled.
- 3 These functions can be returned by setting the Power Switch to the OFF position.

The recorded images are consecutively displayed on the LCD monitor frame frame for every 10 seconds.

1 Set the Slide Mode Switch to the [PLAY] position.

Select the number of image frame you want to view first by pressing the UP/DOWN buttons.

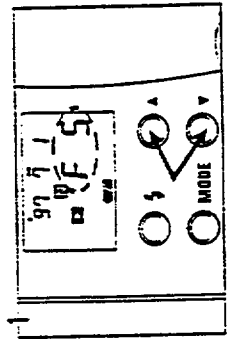

2 Press the Mode Button until [] appears on the LCD panel.

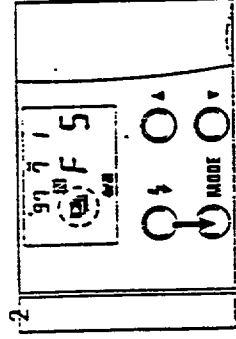

3 Press the Shutter Release Button halfway down. The images are displayed consecutively frame by frame in order for 10 seconds.

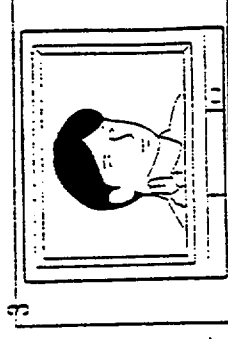

- In the Continuous Playback Mode, the image on the monitor does not go off if the camera is left unused for over 30 seconds.

MULTI-IMAGE PLAYBACK

4 - IMAGE DISPLAY

Four images are displayed on the LCD monitor simultaneously.

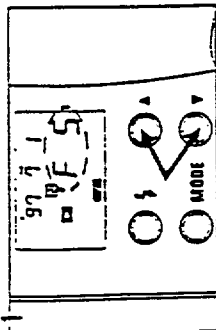

1 Set the Slide Mode Switch to the [PLAY] position. Press the **▲** or **▼** button to select your desired image by the frame number.

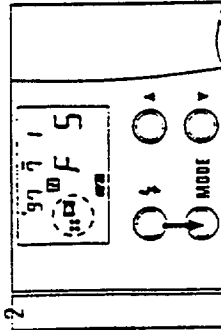

2 Press the Mode Button until [] appears on the LCD panel.

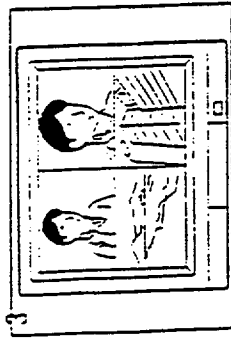

3 Press the Shutter Release Button halfway down. Four images are displayed on the LCD monitor. Your selected image will be displayed in the upper-left corner on the LCD monitor.

To Cancel

Turn the Power Switch Off and then back On or set the Slide Mode Switch to any position other than the [PLAY] position.

- The images on the monitor automatically go off when the camera is left unused for over 30 seconds. Going off the image automatically can be canceled. See page 26 for more details.
- If the AC Adapter is connected to the DC Input Terminal of the camera, a TV monitor can be viewed without going off the images.
- When the Playback Mode is set in the Multi-Image Display Mode, [PLAY] is always appeared on the LCD monitor. The date and time information do not appear.

9 - IMAGE DISPLAY

Nine images are displayed on the LCD monitor simultaneously.

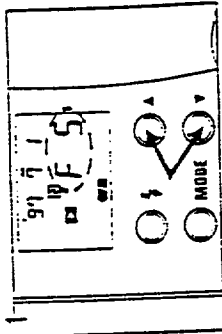

1 Set the Slide Mode Switch to the [PLAY] position. Press the **▲** or **▼** button to select your desired image by the frame number.

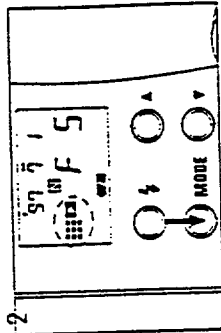

2 Press the Mode Button until [] appears on the LCD panel.

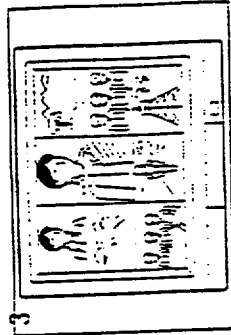

3 Press the Shutter Release Button halfway down. Nine images are displayed on the LCD monitor. Your selected image is displayed in the upper-left corner on the LCD monitor.

To Cancel

Turn the Power Switch Off and then back On or set the Slide Mode Switch to any position other than the [PLAY] position.

- The image on the LCD Monitor automatically goes off if the camera is left unused for over 30 seconds. (This automatic function can be canceled. See page 26 for more details.) If the AC Adapter is connected to the DC Input Terminal of the camera, a TV monitor can be viewed without going off the images.
- When the Playback Mode is set in the Multi-Image Display Mode, [PLAY] is always appeared on the LCD monitor. The date and time information are not appeared.

ERASING IMAGES

SINGLE-IMAGE ERASING

You can erase an image which you do not want.

- 1 Set the Slide Mode Switch to the [ERASE] position. [ERASE] on the LCD panel blinks.

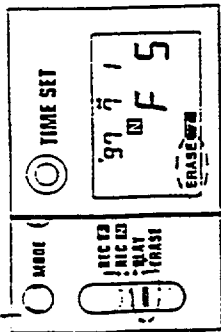

- 2 Select the image which you want to erase by pressing the \blacktriangle or \blacktriangledown button.

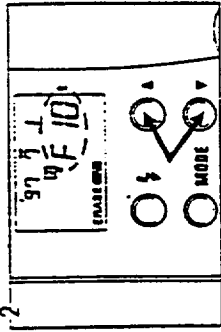

- 3 Press the Mode Button to make [frame number] blink and stop [ERASE] blinking.

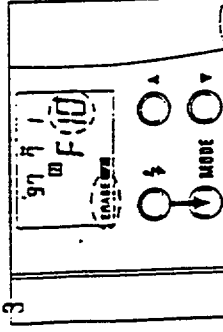

- 4 Press the Shutter Release Button fully down. The selected image is erased.

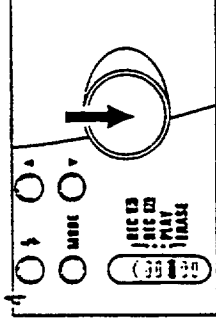

- When the selected image is erased, the [O] indicators appear on the LCD panel and the selected frame number on the LCD panel disappear.

ERASING ALL IMAGES

Note:

The following procedures erase all images recorded in the built-in flash memory and cannot be recovered. Make sure that you really do not need the images you are erasing.

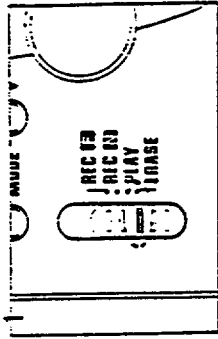

- 1 Set the Slide Mode Switch to the [ERASE] position.

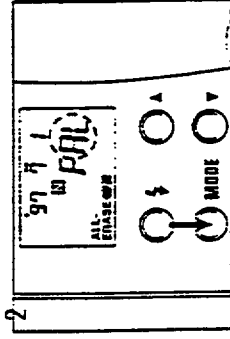

- 2 Press the Mode Button until [ALL-ERASE] and blinking [AL] appear on the LCD panel.

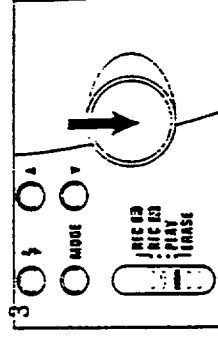

- 3 Press the Shutter Release Button fully down. All images are erased.

- When the Shutter Release Button is pressed fully down, the [O] indicators appear and disappear one by one while erasing all images.

ERASING WHILE VIEWING THE IMAGE ON THE LCD MONITOR

1 Enter the Playback Mode. (See page 25.)

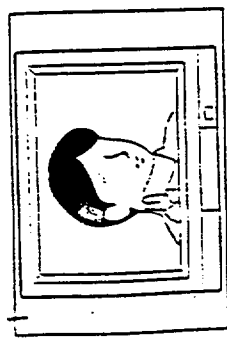

2 Select the image which you want to erase by pressing the ▲ and ▼ button.

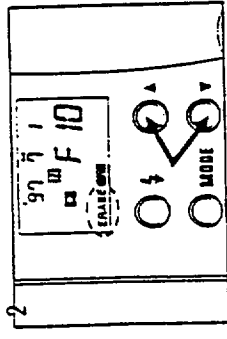

3 Set the Slide Mode Switch to the [ERASE] position. [ERASE] on the LCD panel and [SINGLE] on the LCD monitor blink.

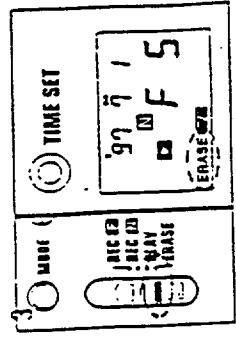

4 Press the Mode Button until [ERASE] stops blinking and the [frame number] on the LCD panel and LCD monitor blink.

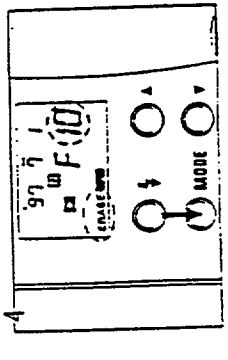

5 Press the Shutter Release Button fully. The image appearing on the LCD monitor is erased.

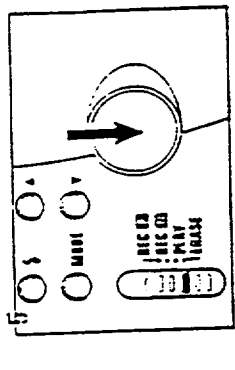

All images can be erased in the same manner as Page 31 and 32 while viewing the images on the LCD monitor. [ALL] and [FORMAT] appear on the LCD monitor in step 2.

When the Shutter Release Button is pressed fully, the [O] indicators appear and disappear one by one while erasing the picture.

INITIALIZATION

Initialization erases all images and any other data information stored in the built-in flash memory or in the PC card.

Note:

The following procedures erase all images and data stored in the built-in flash memory or the PC card and cannot be recovered. Make sure that you really do not need any of the images and data you are erasing.

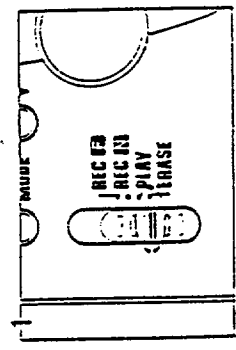

1 Set the Slide Mode Switch to the [ERASE] position.

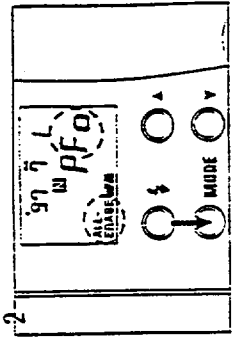

2 Press the [MODE] button until [ALL-ERASE] indicator lights up and [Fo] blinks on the LCD panel.

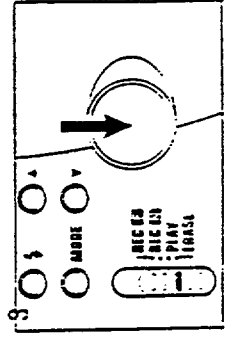

3 Press the Shutter Release Button fully down. All images and data stored in the built-in flash memory or the PC card are erased.

When the release button is pressed fully down, the [O] indicators appear on the LCD panel and disappear one by one while erasing all data and images.

RECORDING TO THE PC CARD

If the PC card is installed to the camera, images are automatically recorded to the PC card. If you intend to take many pictures, use of the PC card is recommended.

Notes

- Use of a Pentax PC card is recommended. Performance may vary if other manufacturers' cards are used. If you use other manufacturers' cards, use only the memory card conforming to ATA standard or PCMCIA/JEIDA standard.
- See page 34 for the number of storage frames when the PC card is used.

Handling precautions for a memory card

- Do not subject the card to strong shock or pressure.
- Avoid using or storing the PC card in places where static electricity or electromagnetic interference is discharged.
- Avoid using or storing the camera in places where temperature and humidity are high.
- Do not turn off the power or remove the batteries while recording data to the PC card. Doing so may corrupt image data already stored in the PC card.
- A PC card has a limited life expectancy. After a long period of use, the card may be unable to record data.
- Recorded data can be lost if the PC card malfunctions, is mishandling or subjected to static electricity or electromagnetic interference. PENTAX does not assume any responsibility for any loss of or damage to recorded images if you experience malfunctions during recording or playback.

Number of storage frames when the built-in flash memory or PC card is used

Recording Mode	Built-In Flash Memory	PC card (2MB)	PC card (4MB)	PC card (10MB)	PC card (20MB)
Normal Recording Mode	18	20	39	101	207
Fine Recording Mode	1	1	3	8	16

The number of storage frame may change if the PC card is initialized by a personal computer.

INSERTING THE PC CARD

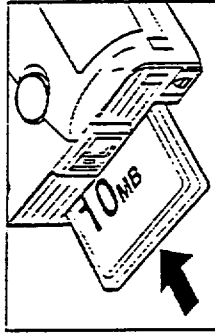

Insert the PC card into the PC Card Slot with the front surface of the card facing up. Push the PC card all the way into the slot until the edge of the card is flush with the PC card slot opening. If the PC card is properly inserted, [CARD] appears on the LCD panel.

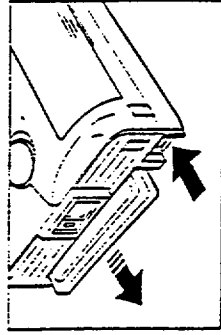

To remove the PC card from the camera, press the PC Card Eject Button.

- If the PC card is inserted, images are recorded to the PC card.
- If the PC card is used and its memory capacity is not sufficient for recording, the images are automatically recorded to the built-in flash memory.
- If you use the PC card other than Pentax made, you must initialize the card in the camera. For details for initialization, see page 33.
- If the PC card without initialized is used, [ErF] appears on the LCD panel.
- When the PC card is inserted, the frame number appears without the letter F.
- If the PC card is set to the write-protect position, [Pr] appears on the LCD panel with the camera set to the recording, deleting or copying mode.
- If the SRAM card is used and its battery power is getting weak, [EC - bc] appears on the LCD panel. [bc] appears on the LCD panel when the battery is exhausted and all data stored in the card will be deleted.

CONNECTING TO AN AC ADAPTER

If you use the camera for a long period of time, it is recommended to connect the camera to an AC outlet with an optional AC Adapter.

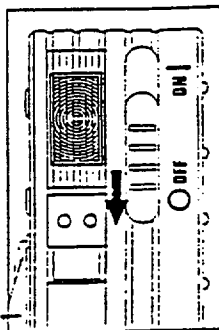

1 Set the Power Switch of the camera to the OFF position.

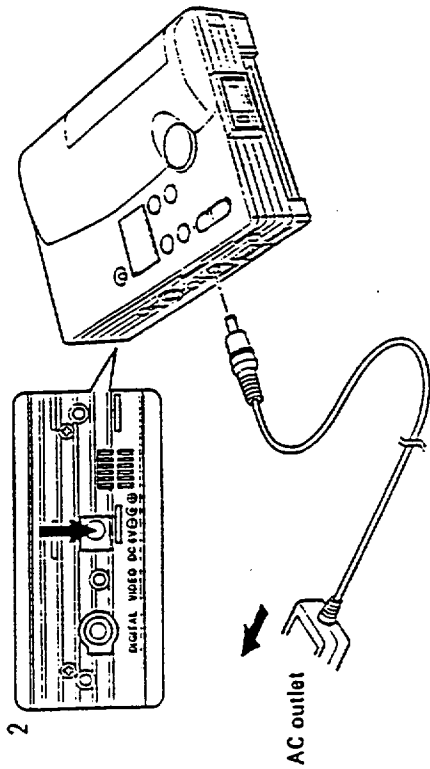

2 Connect the connection cable of the AC Adapter to the DC Input Terminal of the camera.
3 Plug the AC adapter to an AC outlet.

- If the optional LCD monitor (EL-L90) is attached to the camera, connect the plug of the AC Adapter to the DC Input Terminal of the LCD monitor.
- Be sure to turn off the power before connecting or disconnecting the AC adapter.
- Please also read the operating manual of the AC Adapter.
- The illustration of the AC Adapter shown herein may differ from the AC Adapter's actual appearance. Check the standard power plug configurations that are used in your country, or contact your local distributor.

COPYING IMAGES

The recorded images can be copied either from the camera's built-in flash memory to the PC card or vice versa.

Copying the selected images in the built-in flash memory to the PC card.

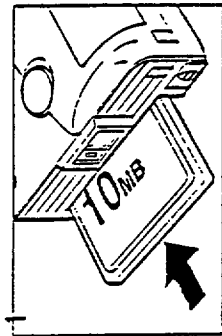

1 Insert the PC card into the PC Card Slot of the camera.

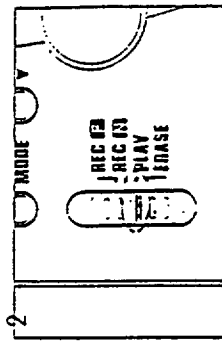

2 Set the Slide Mode Switch to the [PLAY] position.

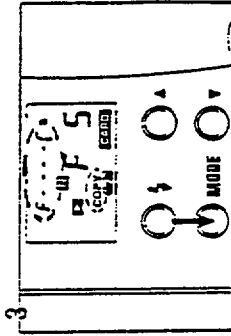

3 Press the Mode Button until [F - - C] and [COPY] appear on the LCD panel.

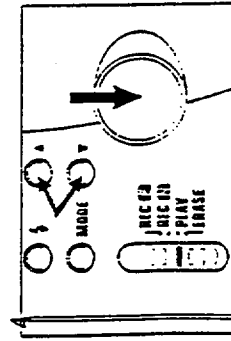

4 Select the frame number you want to copy by pressing the ▲ or ▼ button. Press the Shutter Release Button fully. The selected image in the built-in flash memory is copied to the PC card.

Copying procedures of the PC card to the built-in flash memory is the same manner as steps 1 -4. Only step 3 changes from [F - - C] to [C - - F].

Copying all pictures in the built-in flash memory to the PC card.

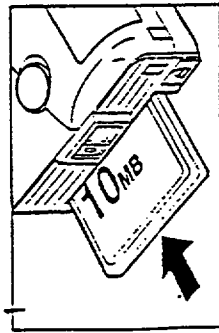

1 Insert the PC card into the PC Card Slot in the camera.

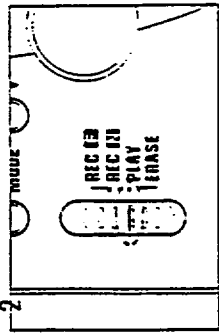

2 Set the Slide Mode Switch to the [PLAY] position.

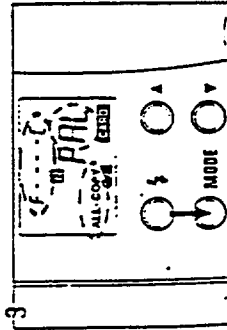

3 Press the Mode Button until [F - - - C], [ALL-COPY] and blinking [AL] appear on the LCD panel.

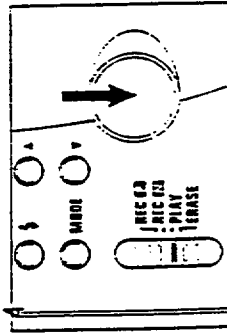

4 Press the Shutter Release Button fully. All pictures in the built-in flash memory are copied to the PC card. To exit the copy mode, press the Mode Button until [] appears on the LCD or set the Slide Mode Switch to a position other than [PLAY].

Copying procedures of the PC card to the built-in flash memory is the same manner as steps 1 - 4. Only step 3 changes from [F - - - C] to [C - - - F].

- If the PC card has a sufficient capacity for copying, [C-000] appears on the LCD panel. [F-000] appears if the built-in flash memory is used and it has a sufficient capacity for copying.
- If the PC card does not have a sufficient capacity for copying, [C-FULL] appears on the LCD panel. [F-FULL] appears if the built-in flash memory is used and it does not have a sufficient capacity for copying.

Copying while viewing images on the LCD monitor

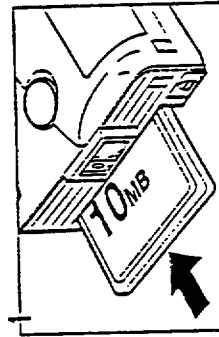

1 Insert the PC card to the PC Card Slot of the camera.

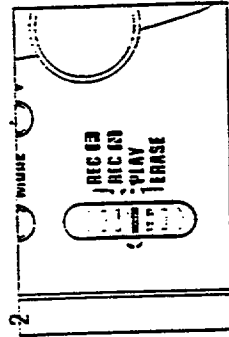

2 Set the Slide Mode Switch to the [PLAY] position.

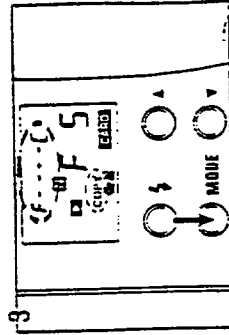

3 Press the Mode Button until [COPY] and [C - - - F] or [F - - - C] appear on the LCD panel.

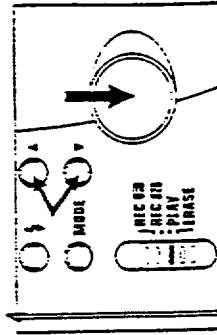

4 Select the frame number which you want copy by pressing the ▲ or ▼ button. Press the Shutter Release Button fully. The selected image in the built-in flash memory is copied to the PC card.

- [C - - - F] appears on the LCD panel while the image in the built-in flash memory is copying to the PC card. [F - - - C] appears on the LCD panel while the image in the PC card is copying to the built-in flash memory.
- To display the images on the LCD monitor, see page 25.

What appears troublesome may be easily remedied. Here are some problems that may occur and their remedies. Before contacting a Pentax service center, check the following items.

Symptom	Cause and Remedies
1 Symptom No power	Cause 1 • Batteries are not loaded properly (p.10) • AC Adapter is not corrected properly (p.36)
2 Symptom Sudden power failure	Cause 2 Power is automatically off when the camera is left unused for over 1 minute. (p.12)
3 Symptom No recording when the shutter button is pressed	Cause 3 Batteries are exhausted (p.10,11) No batteries are loaded (p.12) AC Adapter is not corrected properly (p.36) Memory is full (p.14) Memory card is expired (p.34)
4 Symptom The flash does not fire	Cause 4 The flash is being charged. Wait until the flash is charged. (p.17) Macro Mode is being set. (p.19)
5 Symptom The color of image is not natural.	Cause 5 Auto-White balance system is not operating properly. Include a white or light-colored object in the subject. (p.15)
6 Symptom Cannot playback	Cause 6 No recording when the shutter button is pressed. (p.26) Connect the LCD monitor or TV monitor properly. (p.25)
7 Symptom Sudden power failure for LCD monitor.	Cause 7 The image displayed on the monitor goes off. The camera is left unused for over 30 second. (p.24, 26)

If the [Ec] mark appears on the LCD panel, reset the power. If the mark disappears, the camera is ready for use. The camera may be defective if the mark does not disappear.

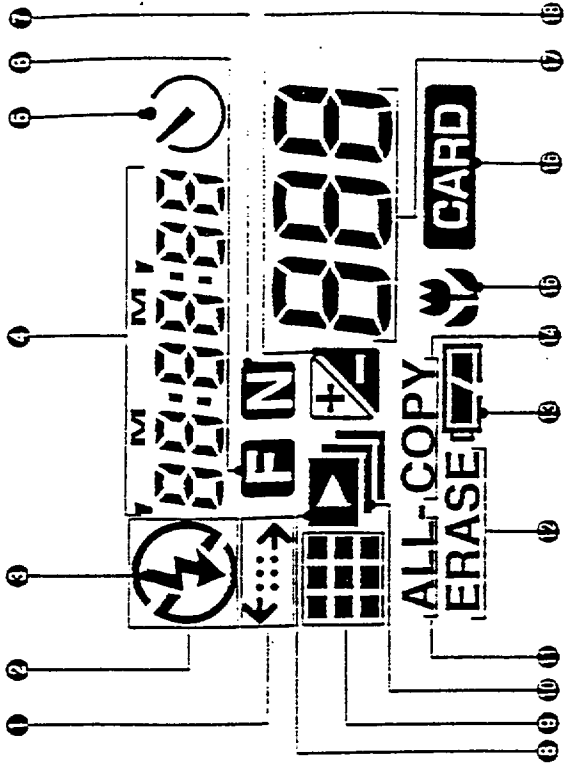

- ① PC Transfer Mode (p.2)
- ② Flash OFF (p.17)
- ③ Flash-ON (p.16)
- ④ Date/Time (p.20)
- ⑤ Self-Timer (p.18)
- ⑥ Fine Recording Mode (p.14)
- ⑦ Normal Recording Mode (p.14)
- ⑧ Playback Mode (p.25)
- ⑨ Multi-Image Playback Mode (p.28, 29)
- ⑩ Continuous-Playback Mode (p.2)
- ⑪ All Erasing Mode (p.33)
- ⑫ Erasing Mode (p.30, 31, 32, 33)
- ⑬ Battery Exhaustion Warning (p.37, 38, 39)
- ⑭ Copying Mode (p.37, 38, 39)
- ⑮ Macro Shooting (p.19)
- ⑯ PC card (p.35)
- ⑰ Number of Remaining Frames (p.22)
- ⑱ Exposure Compensation (p.22)

LCD (Liquid-Crystal Display)

When the LCD panel is exposed to high temperatures over approximately 60°C may blacken, but when the temperature normalizes, it should return to normal

SPECIFICATIONS

- Recording Format Digital recording (uncompressed/ TIFF and compressed / JPEG).
- Recording Medium PCMCIA/ JEIDA standard or PC card (ATA flash card or SRAM card)
- Built-in Flash Memory 2 MB
- Memory Capacity Normal Recording Mode (approx. 100KB), Fine Recording Mode (approx. 1.3MB)
- Imaging Sensor 1/4" CCD with 410,000 pixels (effective 380,000 pixels)
- Monitor Signal Format Conforms to NISC standard format
- Lens Fixed-focus 5.2mm f/2.8 lens (equivalent to 50mm lens in 35mm-film format), 5 elements in 4 groups
- Focusing Range 1m (3.3 ft) - infinity, 2cm - 1m (0.8 in. - 3.3 ft) at Macro setting
- Viewfinder Optical viewfinder, Viewfinder area : 82%, Magnification : 0.64X, Green lamp lighting : within correct exposure range, Green lamp illuminated : beyond correct exposure range, Red lamp illuminated : Flash ready status, Red lamp blinking : Flash being charged, within correct exposure range, Orange lamp illuminated : beyond correct exposure range
- Exposure Control Programmed auto-exposure control, Range : EV9 - EV19 (ISO 100) Auto exposure with Auto Flash Mode, EV6 - EV19 in Auto exposure with Flash - OFF Mode (ISO 100), EV9 - EV15 (ISO 100) in Flash - ON Mode, EV9 - EV19 with a monitor attached.
- Exposure Meter Center weighted TTL metering
- Exposure Compensation 1/2 - 2EV in 0.5EV step increments
- Flash Built-in type auto flash, Effective range | - 3m (3.3 - 9.8 ft) Flash recycling time : approx. 3 seconds
- Shutter speed 1/8 sec. - 1/4000 sec.
- Shooting Method Single frame shooting, Self-timer shooting, Monitored single frame shooting with monitoring.
- Self-timer Built-in type with 10-second delay
- White-Balance Automatic
- Playback Mode Single, Continuous, Multi - image display (4 - image, 9 - image)
- Erasing Mode Single-image erasing, All image erasing, Initialization.
- Copying Mode Single-image copying or all image copying, possible to copy from Built-in flash memory to PC card or vice versa.
- Image Transmission to a PC Serial transmission with EY190 interface cable connected
- Date Function Crystal quartz controlled; LCD with digital clock, auto calendar up to 2079.
- Date Mode Year, Month and Day*, Month, Day and Year*, Day, Month and Year*, Hours, Minutes and Seconds*
- Power Source Two 3V lithium battery (CR2 or equivalent), AC Adapter (optional)
- Battery Exhaustion Warning Battery exhaustion warning symbol blinks.
- Dimensions and Weight 107(W) x 81(H) x 27(D)mm (4.2" x 3.2" x 1.1"), D: 32mm(1.3") at Grip 180g (6.3 oz)(without battery)
- Accessory Strap, Video cable, Protection cover, cap

WARRANTY POLICY

All cameras purchased through authorized bona fide photographic distribution channels are guaranteed against defects of material or workmanship for a period of twelve months from date of purchase. Service will be rendered, and defective parts will be replaced without cost to you within that period, provided the equipment does not show evidence of impact, sand or liquid damage, mishandling, tampering, injury or chemical corrosion, operation contrary to operating instructions, or modification by an unauthorized repair shop. The manufacturer or its authorized representatives shall not be liable for any repair or alterations except those included in its written consent and shall not be liable for damages from delay or loss of or from other indirect or consequential damages of any kind, whether caused by defective material or workmanship or otherwise; and it is expressly agreed that the ability of the manufacturer or its representatives under all guarantees or warranties herein expressed or implied, is strictly limited to the replacement of parts and Pentax service facilities. No refunds will be made on repairs by non-authorized Pentax service facilities.

Procedure During 12-month Warranty Period

Any Pentax which proves defective during the 12-month warranty period should be returned to the dealer from whom you purchased the equipment or to the manufacturer. If there is no representative of the manufacturer in your country, send the equipment to the manufacturer, with postage prepaid. In this case, it will take a considerable length of time before the equipment can be returned to you owing to complicated customs procedures required. If the equipment is covered by warranty repairs will be made and parts replaced free of charge, and the equipment will be returned to you upon completion of servicing. If the equipment is not covered by warranty charges are to be borne by the owner. If your Pentax was purchased outside of your country where you wish to have it serviced during the warranty period, regular handling and servicing fees may be charged by the manufacturer's representative in that country. Notwithstanding this, your Pentax returned to the manufacturer will be serviced free of charge according to this procedure and warranty policy. In any case, however, shipping charges and customs clearance fees to be borne by the sender. To prove the date of your purchase when required, please keep the receipt or bills covering the purchase of your equipment for at least a year. Before sending your equipment for servicing, please make sure that you are sending it to the manufacturer. Always obtain a quotation for the service charge, and only after you accept the quoted service charge, instruct the service station to proceed with the service.

The local warranty policies available from Pentax distributors in some countries can supersede this warranty policy. Therefore, we recommend that you review the warranty card supplied with your product at the time of purchase, or contact the PENTAX distributor in your country for more information and to receive a copy of the warranty policy.



Asahi Optical Co., Ltd. 1-1, Higashi-cho 1-chome, Chiyoda-ku, Tokyo 100, JAPAN
 Pentax Europe n.v. Watervlietlaan 15, 1930 Zaventem, BELGIUM
 Pentax GmbH, Julius-Wasseler-Strasse, 401, D-22527 Hamburg, GERMANY
 Pentax U.K. Limited Pentax House, Heron Drive, Langley, Slough SL3 8PL, U.K.
 Pentax France S.A. 12/11, rue Jean Poulmarch, 95100 Argenteuil Cedex, FRANCE
 Pentax Benelux B.V. (for Netherlands) Spuiweg 25, 4815 LR Breda, NETHERLANDS
 (for Belgium & Luxembourg) Watervlietlaan 15, 1930 Zaventem, BELGIUM
 Pentax (Schweiz) AG Industriestrasse 2, 8405 Dietlikon, SWITZERLAND
 Pentax Scandinavia AB P.O. Box 690, 75127 Uppsala, SWEDEN
 Pentax Corporation P Inverness Drive East, Englewood, Colorado 80112, U.S.A.
 Pentax Canada Inc. 3111 Universal Drive, Mississauga, Ontario L4X 2E5, CANADA

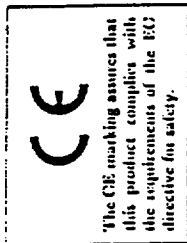

Copyright © Asahi Optical Co. Ltd. 1997
 01 07/07 Printed in Japan

50922 E110 This operating manual is printed on recycled paper.