

PENTAX™

SLR Digital Camera

**ist*D

Operating Manual

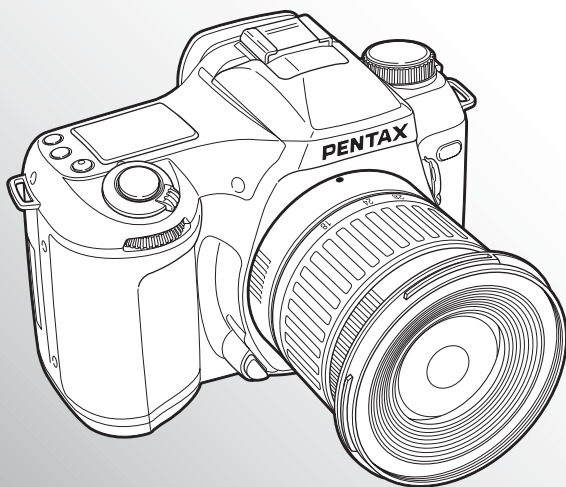

For optimum camera performance, please read the Operating Manual before using the camera.

Thank you for buying the PENTAX **istD* Digital Camera. Please read this manual before using the camera in order to get the most out of all the features and functions. Keep this manual safe, as it can be a valuable tool in helping you to understand all the camera's capabilities.

Lenses you can use

In general, lenses that can be used with this camera are FA J lenses and lenses that have an Aperture A (Auto) position.

To use any other lens or accessory, use the custom function settings to set the camera to allow shutter release in modes other than lens Aperture A.

Under the default settings, the camera will cease to operate.

See page 113 for setting custom functions.

Regarding copyrights

Images taken using the **istD* that are for anything other than personal enjoyment cannot be used without permission according to the rights as specified in the Copyright Act. Please take care, as there are even cases where limitations are placed on taking pictures even for personal enjoyment during demonstrations, industrial enterprise or as items for display. Images taken with the purpose of obtaining copyrights also cannot be used outside the scope of use of the copyright as laid out in the Copyright Act, and care should be taken here also.

Regarding trademarks

- CompactFlash and CF are trademarks of SanDisk Corporation.
- PENTAX is a trademark of PENTAX Corporation.
- **istD* is a trademark of PENTAX Corporation.
- Microdrive is a registered trademark of Hitachi Global Storage Technologies Netherlands, B.U.
- PENTAX PHOTO Browser and PENTAX PHOTO Laboratory are registered trademarks of Pentax Corporation.
- All other brands or product names are trademarks of registered trademarks of their respective companies.
- The USB driver uses software developed by inSilicon Corporation. Copyright © 2002 inSilicon Corporation. All rights reserved.
- This product supports PRINT Image Matching II.
When used in combination, PRINT Image Matching II enabled digital still cameras, printers and software help photographers to produce images more faithful to their intentions.
Copyright 2001 Seiko Epson Corporation. All Rights Reserved.
PRINT Image Matching is a trademark of Seiko Epson Corporation.

To users of this camera

- There is a possibility that recorded data may be erased or that the camera may not function correctly when used in surroundings such as installations generating strong electromagnetic radiation or magnetic fields.
- The liquid crystal panel used in the LCD display is manufactured using extremely high precision technology. Although the level of functioning pixels is 99.99% or better, you should be aware that 0.01% or fewer of the pixels may not illuminate or may illuminate when they should not. However, this has no effect on the recorded image.
- There is a possibility that the illustrations and the display screen of the LCD monitor in this manual are different from the actual product.

FOR YOUR SAFETY

We have paid close attention to the safety of this product. When using this product, we request your special attention regarding items marked with the following symbols.



Warning This symbol indicates that violating this item could cause serious personal injury.



Caution This symbol indicates that violating this item could cause minor or medium personal injury, or material loss.



Warning

- Do not disassemble or modify the camera. High voltage areas are present inside the camera, with the risk of electric shock.
- If the camera interior is exposed due to dropping or otherwise damaging the camera, never touch the exposed portion. There is the risk of electric shock.
- Wrapping the strap around your neck is dangerous. Take care that small children do not hang the strap over their necks.
- Do not look directly at the sun through the camera, as viewing the sun may damage your eyes, and / or parts of the camera (e.g.: shutter curtains, etc.)
- Be sure to store batteries out of the reach of children. Seek medical assistance immediately if accidentally swallowed.
- Always use the AC adapter specified exclusively for this product, with the specified power and voltage. Using an AC adapter not exclusive to this product, or using the exclusive AC adapter with an unspecified power or voltage can cause a fire, electric shock, or camera breakdown.
- If any irregularities occur during use, such as smoke or a strange odor, stop use immediately, remove the batteries or the AC adapter, and contact your nearest PENTAX service center. Continued use could cause a fire or electric shock.
- During thunderstorms, unplug and discontinue use of the AC adapter. Continued use could cause equipment failure, a fire, or electric shock.



Caution

- Do not short the battery or dispose of the battery in fire. Do not disassemble the battery. The battery could explode or catch fire.
- Do not charge any batteries other than rechargeable Ni-MH batteries. The battery could explode or catch fire. Of the batteries that can be used in this camera, only the Ni-MH battery can be recharged.
- Remove the battery from the camera immediately if it becomes hot or begins to smoke. Be careful not to burn yourself during removal.
- Some portions of the camera heat up during use. There is the risk of low temperature burns when holding such portions for long periods.
- Do not place your finger on the flash when it is discharging as there is a risk of burns.

PRECAUTIONS FOR BATTERY USAGE

- Misuse of the battery can cause hazards such as leakage, overheating, explosion, etc. The battery should be inserted correctly with regard to polarity (+ and -) marked on the battery and the camera.
- Battery performance may be temporarily hindered in low temperatures, but will recover in normal temperatures.
- Keep a spare battery on hand for replacement convenience when shooting outdoors or while traveling.
- If the built-in flash is used continuously, the battery may become warm, but it does not mean that the battery is faulty; it is one of the battery's characteristics.
- Replace the batteries at the same time. Do not mix battery brands, type or an old battery with a new one. It may cause explosion or overheating.

Handling the Camera

- Always confirm that the camera is working properly when the camera has not been used for a long time, or before important occasions (weddings, trips, etc.). PENTAX is not responsible for consequential damages (costs incurred for photography, lost profits, etc.) arising from failure of this product.
- Do not clean the product with organic solvents such as thinner, alcohol, or benzene.
- Do not subject to high temperatures or high humidity. Do not leave the camera in a vehicle, as the temperature can get very high.
- Do not store the camera with preservatives and chemicals. Storage in high temperatures and high humidity can cause molding. Remove from case and store in a dry and well-ventilated location.
- This camera is not waterproof, and cannot be used in the rain or where the camera could get wet.
- Do not subject the camera to strong vibrations, shocks, or pressure. Use a cushion to protect the camera from vibrations of motorcycles, automobiles, or ships.
- The temperature range for camera use is 0°C to 40°C.
- The LCD display may appear black under high temperatures, but will return to normal as temperatures normalize.
- The LCD display may respond more slowly at low temperatures. This is due to liquid crystal properties, and is not a fault.
- Periodic inspections are recommended every one to two years to maintain high performance.
- Sudden temperature changes will cause condensation on the inside and outside of the camera. Place the camera in your bag or a plastic bag, retrieving the camera after decreasing the temperature difference.
- Avoid contact with garbage, mud, sand, dust, water, toxic gases, or salts. These could cause a camera breakdown. Wipe dry any rain or water drops on the camera.
- Use a blower or lens brush to remove dust accumulated on the lens or viewfinder. Never use a spray blower for cleaning as it may damage the lens or viewfinder screen.
- See "Precautions When Using a CF Card" (p.151) for details on the compact flash memory card (CF Card).
- Please do not press forcefully on the LCD monitor. This could cause breakage or malfunction.

CONTENTS

FOR YOUR SAFETY	1
PRECAUTIONS FOR BATTERY USAGE	2
Handling the Camera	2
CONTENTS	3
Contents of this manual	7

Before using your camera **9**

Camera Characteristics	10
Checking Package Contents	11
Names of Working Parts	12
Camera	12
LCD Panel Indications	14
LCD Monitor Indications	15
Viewfinder Indications	17

Getting Started **19**

Attaching the Strap	20
Powering the Camera	21
Batteries	22
Battery level indicator	23
Backup battery	23
Number of Captures and Playback Time (new batteries)	24
Using the AC Adapter	25
Turning the Camera On and Off	26
Initial Settings	27
Setting the Display Language	27
Setting the Home Town	28
Setting the D.S.T. Mode	28
Setting the Video Output Format	29
Setting the Date and Time	29
Attaching the Lens	32
Installing / Removing the CF Card	34
Installing	34
Removing	35
Adjusting the Viewfinder Diopter	36

Basic Operation

37

Basic Operation (Shooting)	38
Holding the Camera.....	38
Taking Pictures.....	39
Basic Operation (Playback)	41
Playing Back Images	41
Selecting Previous or Next Images.....	42

Shooting Functions

43

Selecting the Drive Mode	44
Single-frame shooting.....	44
Consecutive Shooting.....	45
Self-Timer shooting.....	46
Remote Control Shooting	49
Setting the Recorded Pixels and Quality Level	51
Setting the Recorded Pixels	51
Setting the Quality Level.....	52
Setting the Sensitivity	54
Setting the White Balance	55
Selecting the Metering Method	57
Using the Multi(16)-Segment Metering	57
Using the Center-Weighted Metering	58
Using the Spot Metering	58
Capture Modes	59
Using the Green Program AE mode.....	59
Using the P (Hyper Program) mode	60
Using the Tv (Shutter-priority) mode.....	62
Using the Av (Aperture-priority) mode	64
Using the M (Hyper manual exposure) mode	66
Using the B (Bulb) mode.....	68
About the AE-L (AE Lock).....	69
Focusing	70
Using the AF.S Autofocus (Single mode)	70
Using the AF.C Autofocus (Continuous mode).....	71
Manual Focus	72
Selecting the focus points.....	74
Focus lock.....	76
Autofocus illuminator	78
Hard-to-Autofocus Subjects.....	78
AF Button.....	78

EV Compensation	79
Using the Zoom Lens	81
Auto Bracketing	82
Multiple Exposure Shooting.....	84
Using the Flash	86
Using the built-in flash	86
Using an External Flash.....	93

Playback Functions 99

Zoom Playback.....	100
Nine-Image Display	101
Deleting Images	102
Deleting a Single Image.....	102
Deleting All Images.....	103
Protecting Images from Deletion (Protect).....	104
Printing Service Settings (DPOF)	106
Single Image Settings.....	106
Settings for All Images.....	108

Settings 111

Setting Menu List.....	112
How to Operate the Settings Menu.....	113
Camera Settings.....	114
Formatting a CF card.....	114
Setting the Custom Functions.....	115
Setting the Color Saturation.....	117
Setting the Image Sharpness	117
Setting the Contrast.....	118
Setting the Instant Review	118
Auto Power Off	119
Turning the Beep On and Off.....	119
Changing the Date Style and Date / Time	120
Setting the World Time	120
Setting the Display Language.....	122
Selecting the Video Output Format.....	123
Setting the LCD Monitor Brightness	123
Resetting the File Number	124
Setting the Slideshow	125

Sensor Cleaning	125
Resetting to Default Settings	126
Custom Function Chart	127
List of City Names.....	130
Connecting	131
<hr/>	
Connecting to a TV	132
Connecting to a PC.....	133
Appendix	135
<hr/>	
More Details about Capture Functions	136
Effect of Aperture and Shutter Speed	136
Calculating flash distance from the aperture used (using built-in flash).....	139
Calculating aperture used from the flash distance (using the built-in flash).....	139
F, FA and FA J Lenses Compatibility with the Built-in Flash	140
Setting the White Balance Manually	142
FUNCTIONS AVAILABLE WITH VARIOUS LENS COMBINATIONS	144
Optional Accessories	146
Battery grip D-BG1	146
AC adaptor D-AC10.....	146
Cable Switch.....	146
Flash Accessories.....	147
For Viewfinder.....	148
Camera Case.....	148
Others	148
Cleaning the CCD.....	149
Precautions Regarding Memory Cards.....	151
Error Messages	152
Troubleshooting.....	153
Main Specifications	154
Specification for Remote Control (Optional)	157
Program lines.....	158
Glossary.....	160
WARRANTY POLICY.....	162

Contents of this manual

This operating manual contains the following chapters.

1 Before using your camera

Explains camera characteristics, accessories and the names of various parts.

2 Getting Started

Explains your first steps from purchasing the camera to taking pictures. Be sure to read it and follow the instructions.

3 Basic Operation

Explains the simplest way to take pictures and play back images. Use it if you want to get started right away.

4 Shooting Functions

Explains how to take better pictures by using the various shooting functions.

5 Playback Functions

Explains how to play back images and how to delete.

6 Settings

Explains setting camera functions.



7 Connecting

Explains how to connect your camera to a TV or PC.

8 Appendix

Explains troubleshooting, introduces accessories sold separately and provides various resources.

The symbols used in this operating manual are explained below.

	Shows reference page number explaining a related operation.
	Shows information useful to know.
	Shows precautions to take when operating the camera.

1 Before using your camera

Camera Characteristics	10
Checking Package Contents	11
Names of Working Parts	12

Camera Characteristics

1

Before using your camera

- Uses a 23.5×15.7mm CCD with 6.1 mega-pixels of effective pixels for high precision and a wide dynamic range.
- Small, light, and highly rigid among digital cameras with interchangeable lenses.
- Consecutive shooting at approximately three 2.6 per second (6 frames max.) with noise reduction off.
- Features a newly developed AF sensor, with 11-point distance measurement. (Center uses a wide cross area AF including 9 focus points.)
- Improved manual focusing using a viewfinder similar to a conventional 35mm SLR camera, but with 0.95× magnification. Also features a superimpose function, in which the focus points on the viewfinder illuminate red.
- Can use two CR-V3 lithium batteries, four AA lithium batteries, four AA Ni-MH batteries or four AA alkaline batteries.
- Features the two-dial hyper operating system.
- Can install the battery grip (sold separately) which uses the same batteries as the camera, extends battery life and has a vertical shutter release button.

This camera can be used with a variety of Pentax 35mm interchangeable lenses.

While the size of the CCD is 23.5×15.7mm, the format size of the 35mm camera is 36×24mm. As a result, the angle of view (the size and scale of the subject to be photographed) will differ from 35mm cameras when lenses of the same focal length are used to take pictures from the same distance.

The format size of a 35mm camera is approximately 1.5 times larger than the format size of this camera. As such, focal distance when the lens for 35mm format lens is attached to this camera will be equivalent to approx. 1.5 times more than the value noted on the lens.

Checking Package Contents

The following accessories are packaged with your camera.



Hot shoe cover F κ
(Supplied with camera)



Eyecup F ι
(Supplied with camera)



ME Viewfinder cap



Body mount cover
(Supplied with camera)

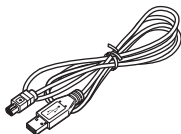

USB cable
I-USB2



Video cable
I-VC2

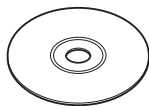

Software (CD-ROM)
S-SW10

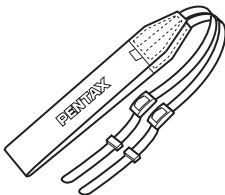

Strap
O-ST10

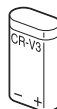

Lithium batteries
CR-V3 (two)



Lithium battery CR2016
(Installed on camera)

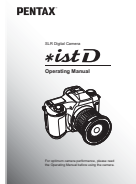

Operating manual



PENTAX PHOTO Browser
PENTAX PHOTO Laboratory
Operating manual

Camera

1

Before using your camera

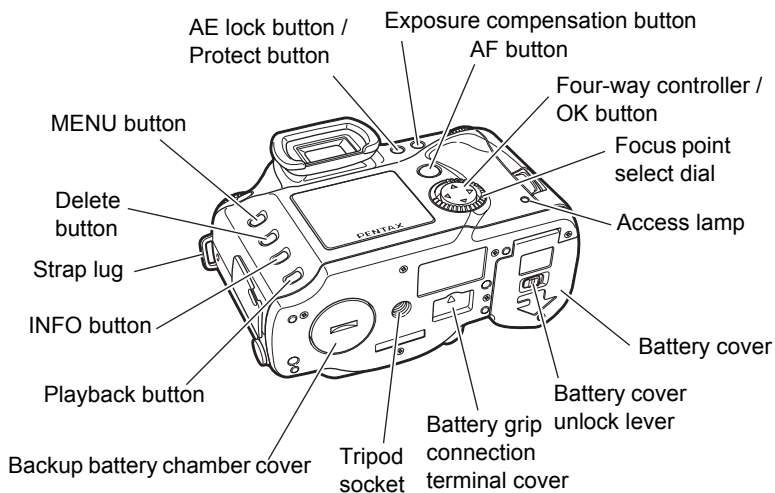
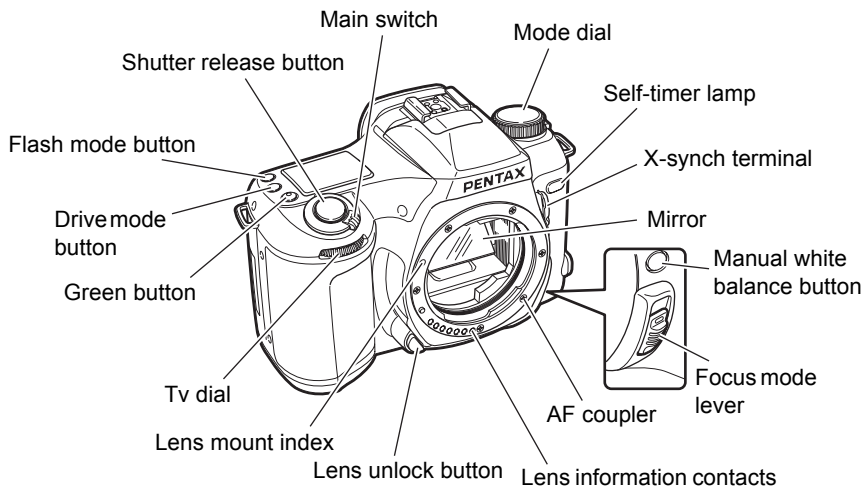

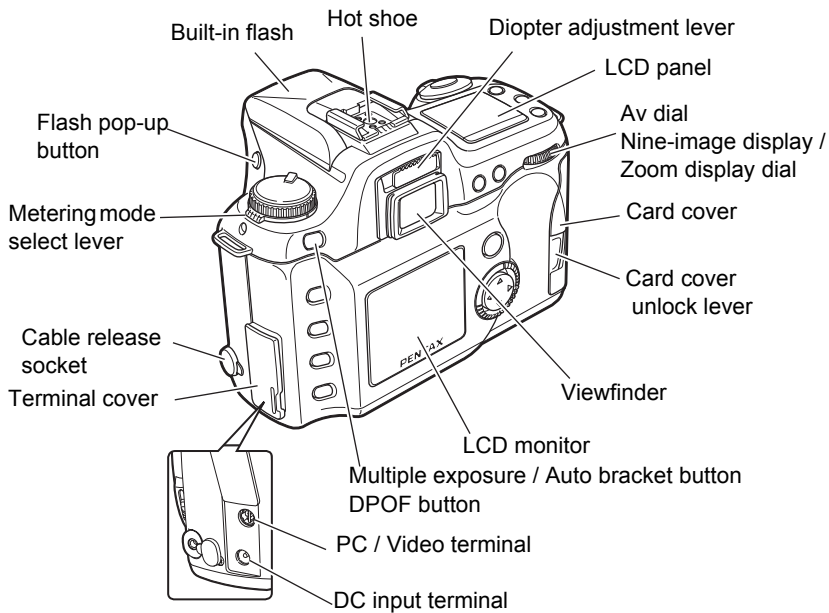

LCD Panel Indications

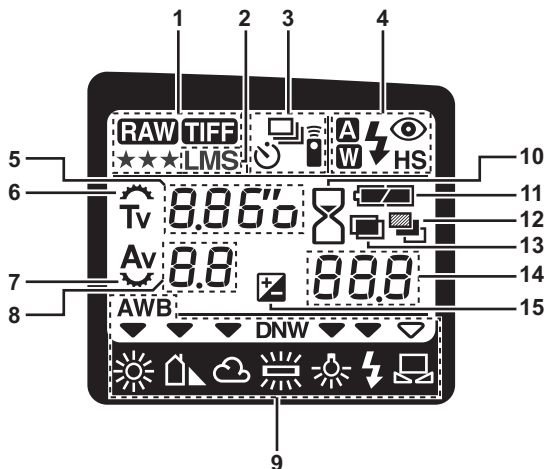

- | | | | |
|---|------------------------|----|-----------------------------------|
| 1 | Quality level (p.52) | 9 | White balance mode (p.55, 142) |
| 2 | Recorded Pixels (p.51) | 10 | Busy |
| 3 | Drive mode (p.44) | 11 | Battery exhaustion warning (p.24) |
| 4 | Flash mode (p.86) | 12 | Auto Bracket (p.82) |
| 5 | Shutter speed (p.62) | 13 | Multiple exposure shooting (p.84) |
| | Sensitivity (p.54) | 14 | Number of recordable images |
| 6 | Tv dial enabled (p.62) | | Exposure compensation step (p.79) |
| 7 | Av dial enabled (p.64) | | Multiple exposure frames (p.84) |
| 8 | Aperture (p.64) | 15 | Exposure compensation (p.79) |



Turn the main switch to to see the LCD panel in the dark. The LCD panel will light up for about 10 seconds. The LCD panel on the AF360FGZ will also light up when the AF360FGZ is used.

LCD Monitor Indications

1. Capture Mode

Press the INFO button in capture mode to display the capture function settings on the LCD monitor.

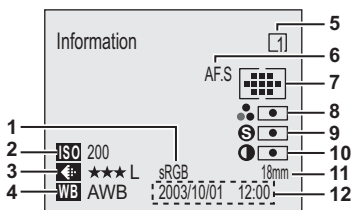

- | | | | |
|---|--|----|---------------------|
| 1 | Color space (p.128) | 7 | Focus points (p.74) |
| 2 | Sensitivity (p.54) | 8 | Saturation (p.117) |
| 3 | Quality level / Recorded pixels (p.51, 52) | 9 | Sharpness (p.117) |
| 4 | White Balance (p.55, 142) | 10 | Contrast (p.118) |
| 5 | Custom Function (p.115) | 11 | Lens focal length |
| 6 | Focus mode (p.70) | 12 | Date and Time |

2. Playback

The camera switches between Normal Playback Screen → Histogram Display → Detailed Information Display every time you press the INFO button during playback.

• Histogram

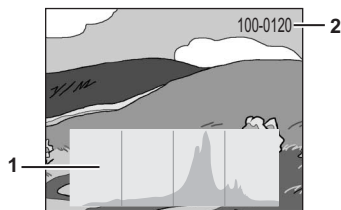

• Detailed information

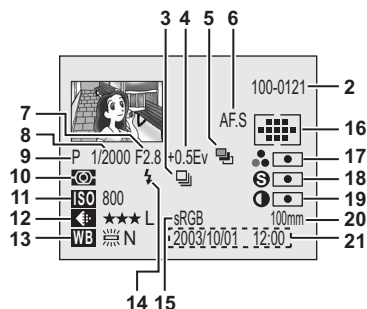

- | | |
|--|---|
| 1 Histogram | 10 Metering mode (p.57) |
| 2 Folder name / File name (p.124) | 11 Sensitivity (p.54) |
| 3 Drive mode (p.44) | 12 Recorded quality / pixels (p.51, 52) |
| 4 Exposure compensation step (p.79) | 13 White balance (p.55, 142) |
| 5 Auto bracket / Multiple exposure (p.82, 84) | 14 Flash mode (p.86) |
| 6 Focus mode (p.70) | 15 Color space (p.128) |
| 7 Aperture value (p.64) | 16 Focus points (p.74) |
| 8 Shutter speed (p.62) | 17 Saturation (p.117) |
| 9 Capture mode | 18 Sharpness (p.117) |
| <input type="checkbox"/> :Green program AE mode (p.59) | 19 Contrast (p.118) |
| P :Hyper-Program (p.60) | 20 Lens focal length |
| Tv :Shutter speed-priority AE (p.62) | 21 Captured date and time |
| Av :Aperture-priority AE (p.64) | |
| M :Hyper-Manual (p.66) | |



Press the four-way controller (▲▼) in the histogram display to move the histogram display position up or down.

Viewfinder Indications

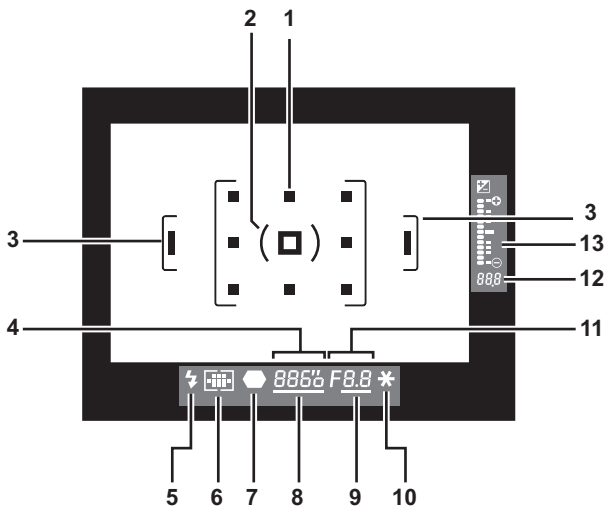

- | | | | |
|---|--------------------------|----|-----------------------------|
| 1 | Focus points | 8 | Tv dial enabled |
| 2 | Spot metering frame | 9 | Av dial enabled |
| 3 | Autofocus frame | 10 | AE Lock indicator |
| 4 | Shutter speed | 11 | Aperture value |
| 5 | Flash status information | 12 | Number of recordable images |
| 6 | Focus points indication | | Exposure compensation step |
| 7 | Focus indicator | 13 | Bar graph |



The focus points are superimposed in red when the shutter release button is pressed halfway down. The superimpose function can be canceled using the custom function. See page 115 for setting Custom Functions.

2 Getting Started

Attaching the Strap	20
Powering the Camera.....	21
Turning the Camera On and Off.....	26
Initial Settings.....	27
Attaching the Lens	32
Installing / Removing the CF Card.....	34
Adjusting the Viewfinder Diopter.....	36

Attaching the Strap

- 1** Pass the end of the strap through the strap lug, then secure to the inside of the clasp.

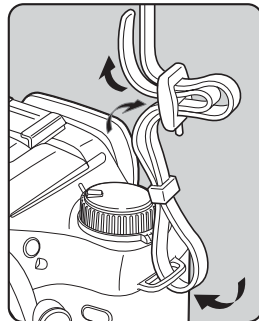

- 2** Pass the other end of the strap through the other strap lug on the camera, then secure to the inside of the clasp.

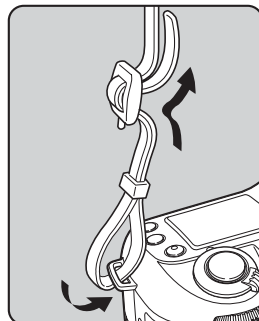

Load batteries in the camera. Use two CR-V3, or use four AA lithium batteries, AA Ni-MH batteries, or AA alkaline batteries.

- 1** Open the battery cover by pushing the battery cover unlock lever as shown in the illustration and slide the battery cover toward the lens before flipping it open.

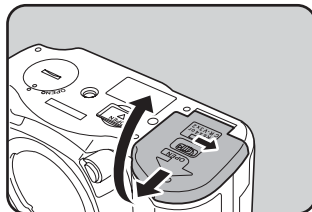

- 2** Insert the batteries according to the + / - indicator in the battery chamber.

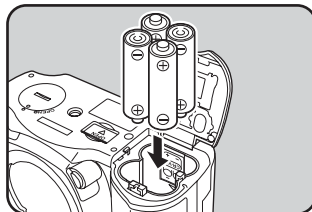

- 3** Press down on the batteries with the battery cover to close and slide it as shown in the illustration.

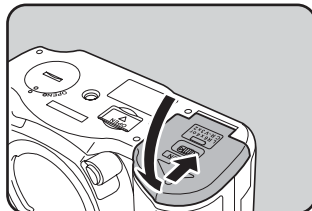

- Please use the AC adapter when using the camera for a prolonged period. (p.25)
- Check the battery orientation if the camera will not operate properly after replacing the batteries.
- The optional battery grip D-BG1 is also available.



- AA lithium batteries, AA alkaline batteries and CR-V3 are not rechargeable.
- Do not open the battery cover or remove the batteries when the power switch is on.
- Remove the batteries when you will not use the camera for a long while. Otherwise, the battery may leak.
- If the date and time settings have been reset when you insert new batteries after a long while, follow the procedure for "Setting the Date and Time" p.29.
- Insert batteries correctly. Batteries inserted backwards can cause a camera breakdown.
- Replace all the batteries at the same time. Do not mix battery type, brands or an old battery with a new one.

Batteries

You can use a variety of batteries with your camera. Battery performance differ by battery type. Please choose the type that best suits your purpose.

CR-V3

The provided CR-V3 is a long-life battery and is convenient for trips.

AA Ni-MH battery

These are rechargeable for multiple uses and are economical.

AA lithium batteries



It is recommended that you use these batteries in cold climates. It shows a fine performance in such cold temperatures.

AA alkaline batteries

You can use readily available AA alkaline batteries when your usual batteries run out. AA alkaline batteries may not adequately handle all the camera functions under certain conditions. We do not recommend their use except in emergencies.

Battery level indicator

You can confirm remaining battery life by checking the  displayed on the LCD panel.

	:	Adequate power
↓	:	
	:	Battery is running low
↓	:	
	:	Battery is exhausted
↓	:	
[Battery Depleted]	:	The camera turns off after displaying this message.

Backup battery

When the backup battery is nearly exhausted, the date and time setting screen will appear on the LCD monitor when you change the camera batteries. When this happens, change the backup battery (CR2016). (Replace the battery once every five years.)

1 Turn off the camera.

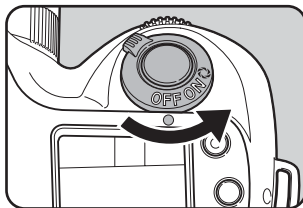

2 Use a coin to remove the backup battery chamber cover.

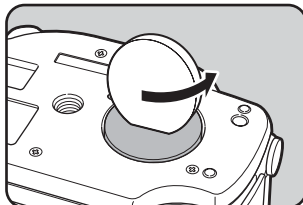

- 3** Remove the backup battery from the backup battery chamber cover using a pen tip or similar object and insert a new backup battery with the + facing towards the cover.

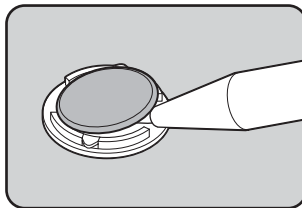

- 4** Close the backup battery chamber cover until it clicks.

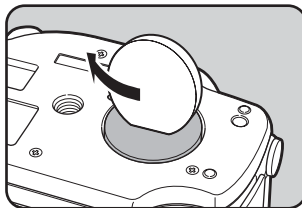

Number of Captures and Playback Time (new batteries)

Batteries (temperature)		Normal recording	Flash photography		Playback time (min.)
			50% use	100% use	
CR-V3	(20°C)	Approx. 1000	Approx. 900	Approx. 800	Approx. 600
	(0°C)	Approx. 650	Approx. 600	Approx. 500	Approx. 400
AA Lithium	(20°C)	Approx. 900	Approx. 800	Approx. 700	Approx. 400
	(0°C)	Approx. 800	Approx. 700	Approx. 600	Approx. 350
Ni-MH	(20°C)	Approx. 450	Approx. 400	Approx. 350	Approx. 300
	(0°C)	Approx. 400	Approx. 350	Approx. 300	Approx. 250
AA-Alkaline	(20°C)	Approx. 110	Approx. 100	Approx. 80	Approx. 120
	(0°C)	Not applicable	Not applicable	Not applicable	Approx. 60

- These figures are based on PENTAX measuring conditions and may vary by capture mode or shooting conditions.



- Battery performance temporarily decreases as the temperature decreases. When using the camera in cold climates, have extra batteries on hand, keeping them warm in your pocket. Battery performance will return to normal when returned to room temperature.
- AA alkaline batteries may not adequately handle all the camera functions. We do not recommend their use except in emergencies.
- When traveling overseas, taking pictures in cold climates, or when you will be taking a lot of pictures, please have extra batteries ready.
- For image storage capacity when using the Battery Grip D-BG1, see p. 146.

Using the AC Adapter

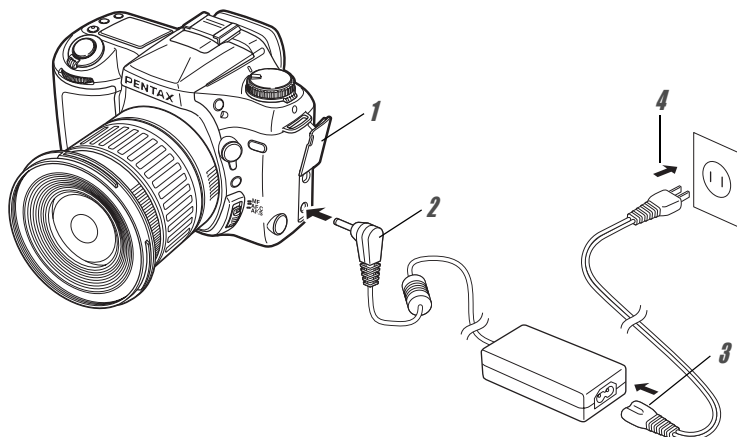

We recommend using the AC adapter D-AC10 (optional) when using the LCD monitor for a long time or when connecting to your PC.

- 1** Make sure the camera is turned off before opening the terminal cover.
- 2** Connect the DC terminal on the AC adapter to the DC input terminal on the camera.
- 3** Connect the AC plug cord to the AC adapter.
- 4** Plug the AC cord into the power outlet.





- Make sure the camera is turned off before connecting or disconnecting the AC adapter.
- Make sure connections are secure between the camera, AC adapter, AC plug cord terminal and the power outlet. Disconnection while the camera is recording or reading data on the CF card will corrupt your data.
- When using the AC adapter, be sure to read the AC adapter D-AC10 operating manual.
- Connecting the AC adapter will not charge the rechargeable batteries in your camera.

1 Turn the main switch to ON.

The camera will turn on.

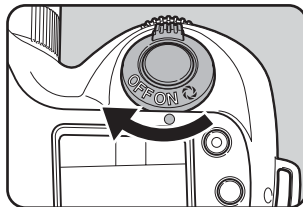
Turn the main switch to OFF to turn off the camera.



- Always turn the camera OFF when not in use.
- Turn the main switch to  to illuminate the LCD panel for about 10 seconds. The depth of field can also be checked in the viewfinder by turning the main switch to  position. See page 138 for preview display.
- Auto Power Off will be activated when you do not perform any operations within a set period of time. (Default setting is 1 minute)

The first time the camera is turned on after purchasing, the “Initial Setting” screen appears on the LCD monitor. Follow the procedure below to set the language displayed on the LCD monitor and the current date and time. Once setting is done, these will not need to be set again when turning your camera on.

Setting the Display Language

You can choose the language in which the menus, error messages, etc. are displayed from the following: English, French, German, Spanish, Italian and Japanese.

1 Turn the camera on.

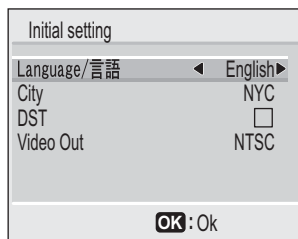

2 Use the four-way controller (◀▶) to select your applicable language.

The default setting is English.

3 Press the four-way controller (▼).

The screen for setting the [City] will be displayed.



You can change the setting after it has been made. Refer to “Setting the Display Language” p.27.

Setting the Home Town

You can choose the city (Home Town) in which you will use the camera.

- 1 Use the four-way controller (◀▶) to select your applicable city (Home Town).

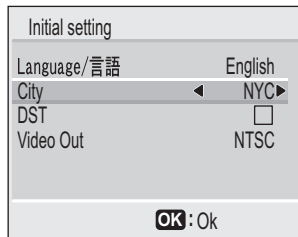

- 2 Press the four-way controller (▼).

The screen for setting the [DST] will be displayed.



- See p.92 for the list of cities and corresponding code names.
- You can change the setting after it has been made. Refer to “Setting the World Time” p.120.

Setting the D.S.T. Mode

You can choose whether or not to display the D.S.T (Daylight Saving Time) mode.

- 1 Use the four-way controller (◀▶) to select (on) or (Off).

The default setting is (Off).

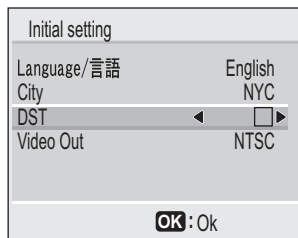

- 2 Press the four-way controller (▼).

The screen for setting the [Video Out] will be displayed.



- You can change the setting after it has been made. Refer to “Setting the World Time” p.120.

Setting the Video Output Format

You can choose the output format (NTSC or PAL) for playing back pictures using a TV monitor.

1 Use the four-way controller (◀▶) to select the video output format.

The default setting is NTSC.

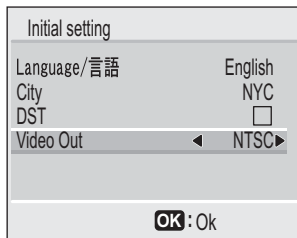

2 Press the OK button.

The screen for setting the [Date and Time] will be displayed.



You can change the setting after it has been made. Refer to “Selecting the Video Output Format” p.123.

Setting the Date and Time

Set the current date and time and the display style.

1 Use the four-way controller (▲▼) to select the date and time display style.

▲▼ are displayed above and below the display style.

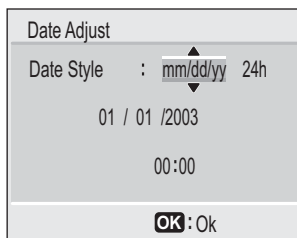

2 Press the four-way controller (▶).

▲▼ are displayed above and below “24h”.

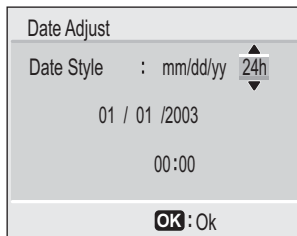

3 Use the four-way controller (▲▼) to select 24h (24-hour display) or 12h (12-hour display).

4 Press the four-way controller (▶).

▲▼ is displayed above and below the month.

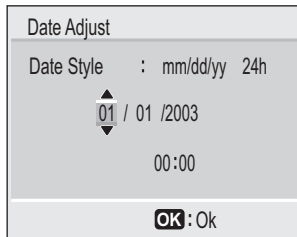

5 Use the four-way controller (▲▼) to change the month.

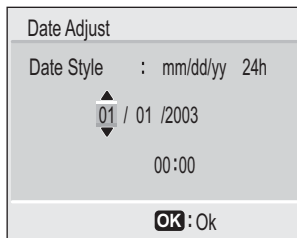

6 Press the four-way controller (▶).

▲▼ are displayed above and below the date.

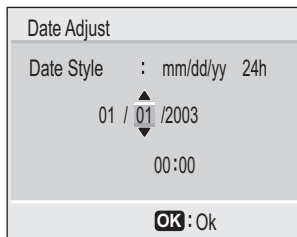

7 Use the four-way controller (▲▼) to set the date and press the four-way controller (▶) again.

▲▼ are displayed above and below the year.

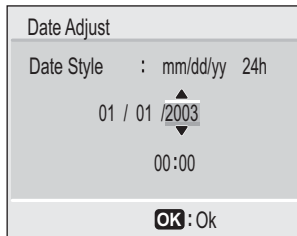

8 Repeat step 7 to set the year, hour and minutes.

9 Press the OK button.

The camera is ready to take a picture. When you set the date and time using the MENU button, you will return to the Menu screen. Press the OK button again.



Press the OK button to set the clock to 0 seconds when the clock reaches 00 second.



- If you press the MENU button before initial settings are complete, your settings will be cancelled, but you can take pictures. If this occurs, the Initial settings screen is appeared the next time the camera is turned on.
- Your settings can be changed later from the Menu screen. To access the menu, see “Changing the Date Style and Date / Time” p.120.

Attaching the Lens

- 1** Remove the body mount cover ① and the lens mount cover ② in the illustration.

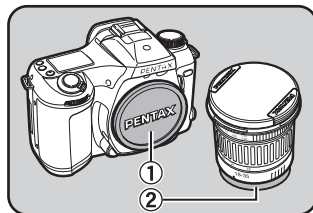

- 2** Align the red dots on the camera and the lens, and secure by turning the lens clockwise until it clicks.

Turn the lens to the left to confirm that it is locked in place after attaching the lens.

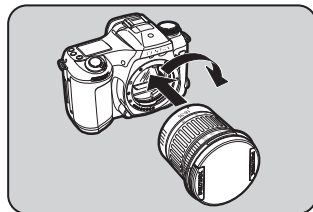

- 3** Remove the front lens cap by pushing the indicated portion inward.

To detach the lens, hold down the lens unlock button and turn the lens counterclockwise.

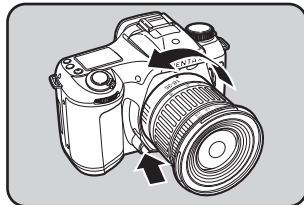
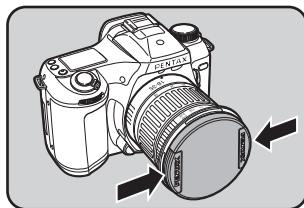



- The body mount cover ① is a cover for shipping purpose to prevent scratches and block dust. For long-term camera storage, the optional accessory “Body Mount Cap K” is available, and has a lock mechanism.
- Turn the camera OFF before attaching or removing the lens to prevent unexpected lens movement.
- Be sure to put the lens down with the lens mount side facing upward to protect the lens information contacts and AF coupler of the lens against damage after removal.
- We assume no responsibility nor liability for damages resulting from the use of lenses made by other manufacturers.
- The camera body and lens mount incorporate lens information contacts and an AF coupler. Dirt, dust, or corrosion may damage the electrical system. Clean the contacts with a soft dry cloth.

Installing / Removing the CF Card

Captured images are recorded on the compact flash (CF) card. Make sure the camera is turned off before installing or removing a CF card (market product).



You can also use a Microdrive™ in addition to a CF card.

2

Getting Started

Installing

- 1 Push the card cover unlock lever in the direction indicated to open the card cover.**

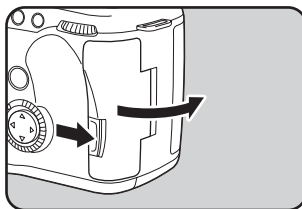

- 2 Insert the card all the way with the CF card label toward the LCD monitor.**

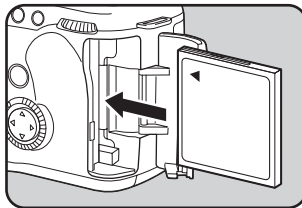

- 3 Close the card cover.**

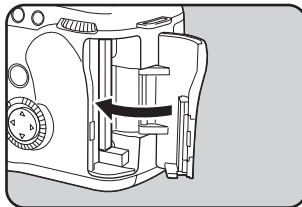

Removing

1 Push the card cover unlock lever in the direction indicated to open the card cover.

2 Press the card eject button to remove the CF card.

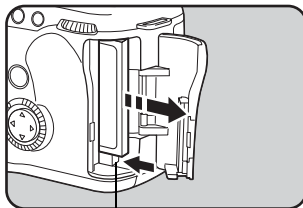

Card eject
button

3 Close the card cover.

Adjusting the Viewfinder Diopter

Adjust the viewfinder to match your eyesight.

- 1 Look through the viewfinder and point and camera at a well-lit scene. Then move the diopter adjustment lever left or right.**

Adjust the position until the autofocus frames and the focus points in the viewfinder are in clear focus.

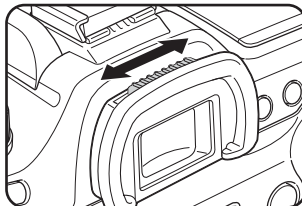

- You can adjust the diopter from $-2.5 \sim +1.5 \text{m}^{-1}$ (Per meter).

3 Basic Operation

Basic Operation (Shooting).....	38
Basic Operation (Playback).....	41

Basic Operation (Shooting)

Holding the Camera

How you hold the camera is important when taking pictures.

- Hold the camera firmly with both hands.
- Press the shutter release button gently when taking a picture.

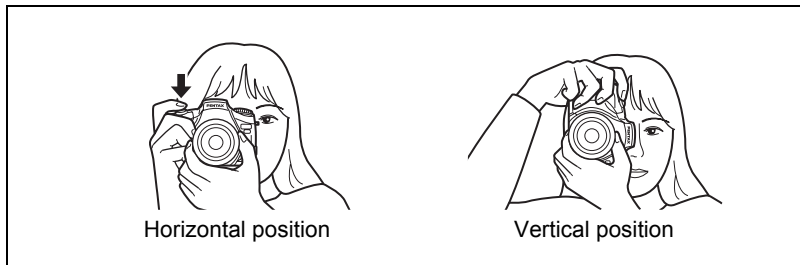

3

Basic Operation



- To reduce camera shake, support your body or the camera on a solid object - a table, tree, or a wall for instance.
- Although there are individual differences among photographers, in general the shutter speed for a hand held camera is $1/\text{focal length} \times 1.5$. For example, it is $1/75$ of a second for a focal length of 50mm and $1/150$ of second for 100mm. A tripod should be used for shutter speeds slower than this.
- When using an telephoto lens, a tripod that is heavier than the total weight of the camera and lens is recommended to avoid camera shake.

Taking Pictures

1 Set the camera to green program AE mode.

Set the mode dial to .
(p.59)

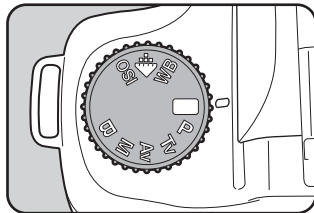

2 Set the focus mode to Autofocus.

Set the focus mode lever to **AF.S**.
(p.70)

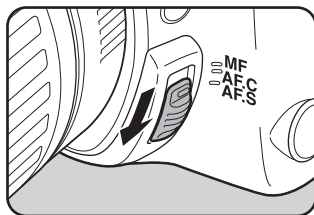

3 Press the flash pop-up button to activate the flash.

You do not need to pop-up the flash when you do not intend to use it.

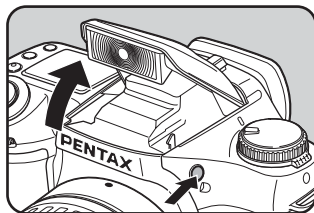

4 Adjust the size of the subject.

Turn the zoom ring to determine the size of the subject.
(p.81)

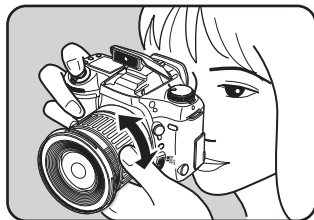

5 Adjust the focus and take a picture.

Position the subject within the autofocus frame and press the shutter release button to take the picture (p.17).

The flash fires automatically based on light conditions.

Push the flash down by hand after you finish taking pictures.

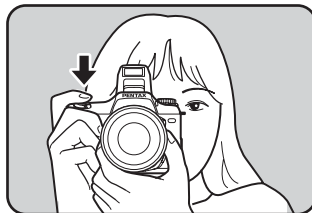

3

OPERATING THE SHUTTER RELEASE BUTTON

The shutter release button has two positions.

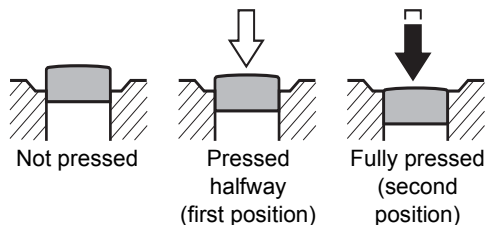

Pressing it down halfway (first position) turns on the viewfinder and LCD display indications and the autofocus system operates. Pressing it fully (second position) takes the picture.



- Press the shutter release button gently to prevent camera shake when taking a picture.
- Practice pressing the shutter release button halfway to learn where the first position is.
- The viewfinder indications stay on for about 10 seconds (initial value) after the button is released from the halfway position. Pressing the shutter release button halfway down keeps the LCD indicator on.

Instant Review

Instant Review displays the image immediately after taking a picture. The Instant Review default setting displays for 1 sec. Press the Delete button (⏏) to display the delete screen while the image is displayed. Press the four-way controller (▲) to select [Delete] and press OK. The image is deleted.

Playing Back Images

You can play back the still pictures.

1 Press the playback button (▶) after taking a picture.

The most recently captured image is displayed on the LCD monitor.

Press the Playback button again, or press the shutter release button halfway to return to capture mode.

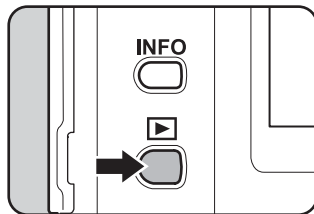

- Pressing the four-way controller (▼) will rotate the image 90°, 180° and 270°. The image captured in vertical position can be displayed for easy viewing. (Only the display is rotated. The recorded image is not updated.)
- The image with the highest file number is shown first when you switch to the playback screen.
- You can enlarge the image displayed on the LCD monitor by turning Nine-image Display / Zoom Display dial. (p.100)
- If no images are stored, the "No Image" message is appeared.

Selecting Previous or Next Images

You can play back the still pictures, cycling through one at a time.

- 1 **Press the playback button (▶) after taking a picture.**

The captured image is displayed on the LCD monitor.

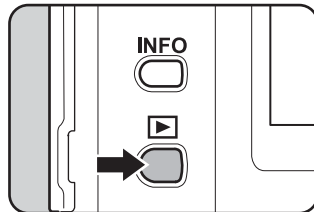

- 2 **Press the four-way controller (◀ or ▶).**

- ◀ Displays the previous image.
- ▶ Displays the next image.

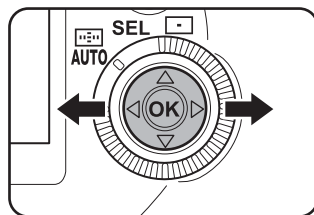

Deleting Images

Press the Delete button (🗑) to display the Delete screen when the image is displayed. Press the four-way controller (▲) to select [Delete] and press OK. The image is deleted.

Press the Playback button again or press the shutter release button halfway to return to capture mode.

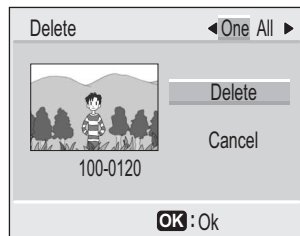
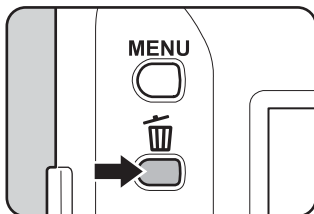



4 Shooting Functions

Selecting the Drive Mode.....	44
Setting the Recorded Pixels and Quality Level	51
Setting the Sensitivity	54
Setting the White Balance	55
Selecting the Metering Method	57
Capture Modes	59
Focusing	70
EV Compensation.....	79
Using the Zoom Lens	81
Auto Bracketing.....	82
Multiple Exposure Shooting.....	84
Using the Flash.....	86

Selecting the Drive Mode

This camera has four drive modes. Set the mode dial to your desired capture mode before selecting the drive mode. (p.59)

<input type="checkbox"/>	Single-frame	One picture is taken each time the shutter release button is pressed. This is the most common drive mode. (p.44)
	Consecutive shooting	Pictures can be taken consecutively while the shutter release button is held down. (p.45)
	Self-timer shooting	Self-timer mode (p.46)
	Remote control shooting	The shutter can be released with the remote control unit. (p.49)

4

Shooting Functions



The Self-timer shooting [☺] and the Remote control shooting [📡] modes will be reset to the Single-frame drive mode when the camera is turned OFF and then ON.

Single-frame shooting

One picture is taken each time the shutter release button is pressed. This is the most common drive mode.

- 1 **Press the drive mode button [☺] until [□] appears on the LCD panel.**

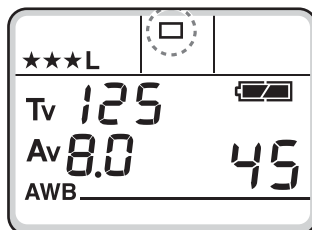
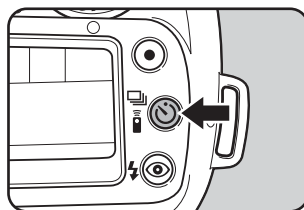

Consecutive Shooting

Pictures can be taken consecutively while the shutter release button is held down.

- 1 Press the drive mode button [] until [] appears on the LCD panel.

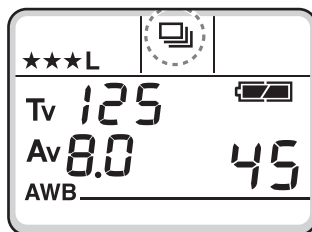
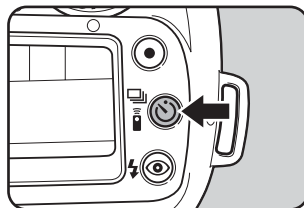

- 2 Press the shutter release button halfway down to focus on the subject.
- 3 Press the shutter release button completely.

Pictures are taken consecutively while the shutter release button is fully pressed. Take your finger off of the shutter release button to stop taking consecutive pictures.



- When the focus mode lever is set to **A.F.S** (single), the focus is locked in the first frame position and used for subsequent continuous frames.
- When the focus mode lever is set to **A.F.C** (continuous), the focus is adjusted for each shot. However, note that the shutter will release even if the focusing is not complete.
- The shutter cannot be released until charging is complete when using the built-in flash. Use a custom function to enable shutter release before the built-in flash is ready. See page 115 for setting Custom Functions.

Self-Timer shooting

Use the self-timer mode to include the photographer in the picture. The shutter will be released about 12 seconds after the shutter release button is pressed.

- 1** Mount the camera to a tripod.



- 2** Press the drive mode button [⏻] until [⏻] appears on the LCD panel.

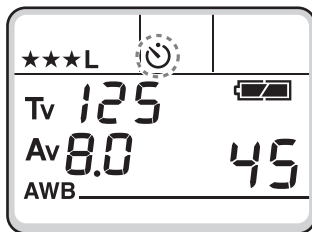
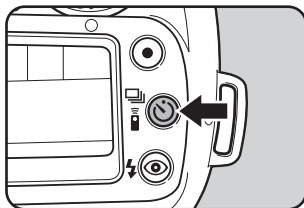

3 Press the shutter release button halfway down to compose and focus on the subject by looking through the viewfinder.

The focus indicator [●] lights up when the subject is in focus.



4 Press the shutter release button completely.

The self-timer lamp starts blinking slowly and blinks rapidly two seconds before the shutter is released. Also the audible PCV signal is heard and the rate increases for the last two seconds. The shutter will be released about 12 seconds after the shutter release button is pressed fully.

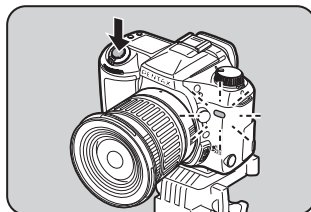

4



- The audible PCV signal can be turned off. See page 119.
- Exposure may be affected if light enters the viewfinder during self-timer operation in any capture mode other than **M** (metered manual exposure). Attach the provided viewfinder cap or use the AE lock function (see page 69).
- Remove the Eyecup F_L by pulling one side upward when using accessories such as the viewfinder cap.

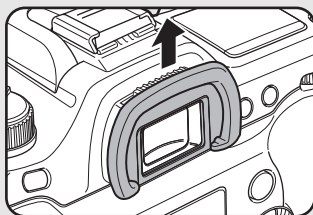

Removing the Eyecup

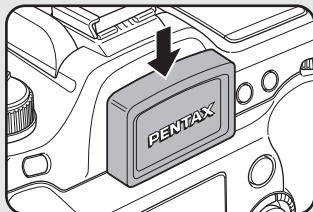

Attaching the viewfinder cap

5 Press the drive mode button [🔄] after the picture is taken.

The drive mode returns to single-frame shooting from self-timer shooting.

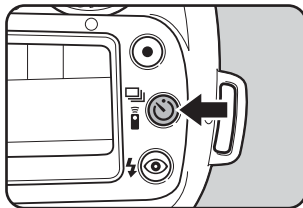

Press the drive mode button to cancel the self-timer operation before it is completed.

4

Mirror lock up function

When this function is set, the mirror stays up and the shutter is released about 2 seconds later when the shutter release button is pressed. You can reduce camera shake caused by mirror movement with mirror lock up.

Follow the procedure below to take a picture with the mirror lock up:

- 1 In Custom Function, set “Self-timer delay time” to “2 sec”. See page 115 for setting Custom Functions.
- 2 Press the drive mode button until 🔄 appears on the LCD panel.
- 3 Focus on the subject and then press the shutter release button completely.

The mirror stays up and the picture will be taken 2 seconds later.

AE lock is enabled with the exposure value immediately before the mirror goes up.

Remote Control Shooting

The shutter can be released with the remote control unit (optional). The shutter will be released 3 seconds after the shutter release button on the remote control unit is pressed.

1 Mount the camera to a tripod.



2 Press the drive mode button [] until [] appears on the LCD panel.



- The camera is not focused by operating the remote control. Focus on the subject first before operating the remote control.
- The self-timer lamp will blink letting you know the camera is in remote control wait status when you display  .

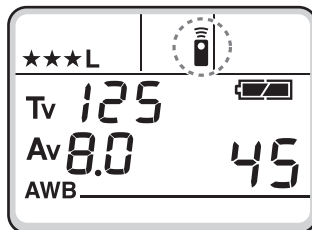
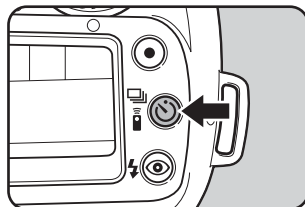

3 Press the shutter release button on the remote control towards the camera.

The shutter will be released 3 seconds after the shutter release button on the remote control unit is pressed. When the picture is taken, the self-timer lamp lights for 2 seconds and will then resume blinking. Press the drive mode button after the picture is taken. The drive mode returns to single-frame drive mode.

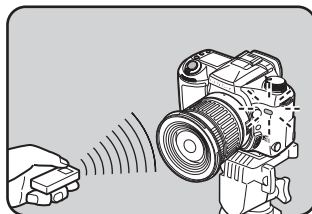



- The operating distance of the remote control unit is approx. 5m from in front of the camera.
- Remote control shooting with the capture mode set to **B** (bulb) mode will allow bulb shooting while the shutter release button on the remote control unit is pressed.
- Exposure may be affected if light enters the viewfinder during remote control operation in any capture mode other than **M** (metered manual exposure). Attach the provided viewfinder cap or use the AE lock function (see page 69). See page 47 for attaching the viewfinder cap.
- You can use a custom function to change the remote control operation time from 3 seconds to immediate operation. See page 115 for setting Custom Functions.
- Press the drive button or turn the main switch off to stop the remote control operation after it has been activated.
- The remote control may not operate in backlit conditions.
- The remote control does not work while the flash is being charged.
- When using the built-in flash, raise the flash into position first.
- The camera automatically returns to single-frame drive mode after the remote control shooting mode is left unused for 5 minutes.
- The remote control unit battery can send a remote control signal about 30,000 times. Please contact PENTAX service center to exchange the battery. (This will involve a fee.)

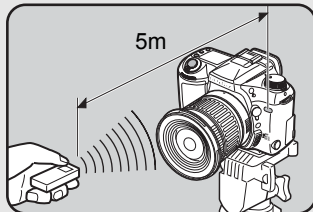

Setting the Recorded Pixels and Quality Level

Setting the Recorded Pixels

You can select the number of recorded pixels from L (3008 × 2008), M (2400 × 1600) and S (1536 × 1024). The more pixels there are the larger the image size and file size. The image file size will also differ according to quality level settings.

L	3008 × 2008	Suited for printing on A3 paper.
M	2400 × 1600	Suited for printing on A4 paper.
S	1536 × 1024	Suited for printing on A5 paper.

- 1 Set the mode dial to .

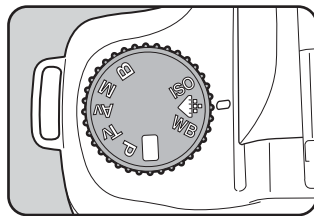

- 2 Select the recorded pixels with the Av dial.

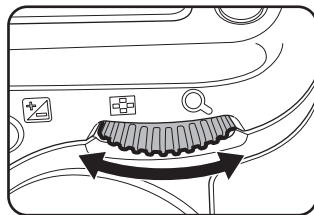

- 3 Confirm the recorded pixels on the LCD panel.

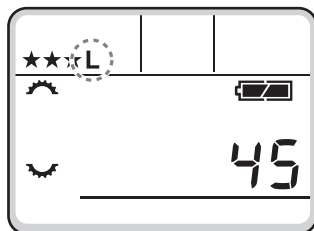

4 Set the mode dial to your desired capture mode.

The camera is ready to take a picture.



- Pressing the green button while setting the recorded pixels will make the size revert to the default value (L).
- You can set a custom function to set the recorded pixels for S to 1536 × 1024, 1152 × 768, or 960 × 640. See page 115 for setting Custom Functions.
- The Recorded Pixels cannot be selected if the Quality Level is set to RAW. (Fixed at 3008 × 2008)

Setting the Quality Level

You can set the image compression rate.

The image file size will also differ according to Recorded Pixels settings.

RAW	RAW	Raw data, just as it was captured. You can process this on your PC using dedicated utility software.
TIFF	TIFF	Image is recorded as uncompressed data. Suited for processing on your PC. Image is saved with "TIFF" extension.
★★★	Best	Lowest compression rate, suited for printing large pictures on A4 paper. Image is saved with "JPEG" extension.
★★	Better	Standard compression rate, suited for viewing as standard photographs or on your computer screen. Image is saved with "JPEG" extension.
★	Good	Highest compression rate, suited for attaching to e-mail, or for creating websites. Image is saved with "JPEG" extension.

- 1** Select the mode dial to .

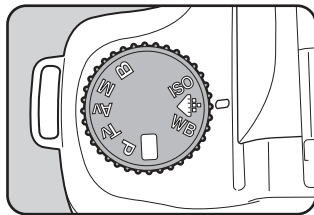

- 2** Select the quality level with the TV dial.

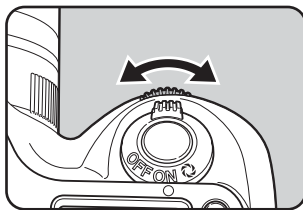

- 3** Confirm the quality level on the LCD panel.

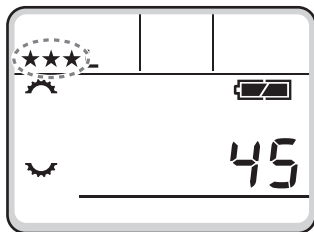

- 4** Set the mode dial to your desired capture mode.

The camera is ready to take a picture.



Pressing the green button while setting the quality level will make the quality level revert to the default value (★★★(Best)).

Setting the Sensitivity

You can set the sensitivity to match the brightness of the surroundings. The sensitivity can be set within a range of sensitivity equivalent to ISO 200 to 1600.

1 Set the mode dial to **ISO**.

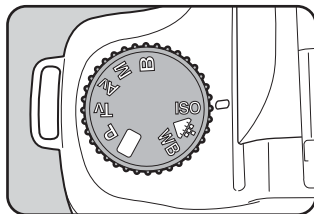

2 Select the sensitivity with the **Tv dial**.

The larger the sensitivity value, the more suitable for darker places, on the other hand, pictures tend to be affected by noise and appear rough.

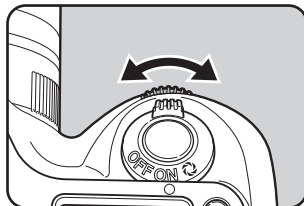

3 Confirm the sensitivity level on the **LCD panel**.

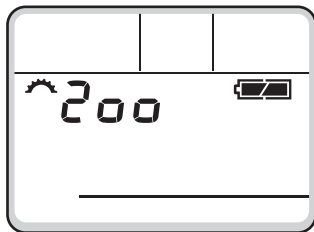







4 Set the mode dial to your desired capture mode.



- Turn the Tv dial counterclockwise to decrease the number. Turn the Tv dial clockwise to increase the number.
- Pressing the green button while setting the sensitivity will make the quality level revert to the default value (Sensitivity 200).
- You can set sensitivity up to 3200 when you select "Wide" in "Sensitivity Range" settings in the Custom Function menu. (p.115)

The color of the subject changes with the light source. For example, the same white object will be a different shade of white in daylight than under a light bulb. In cameras using film, this is adjusted by changing the film or using filters. In digital cameras, the whiteness is adjusted using white balance.

AWB	Automatic	The camera makes the adjustment automatically.
	Daylight	For taking pictures outside in sunlight.
	Shade	For taking pictures outside in the shade.
	Cloudy	For taking pictures on cloudy days.
	Fluorescent Light	For taking pictures under fluorescent light. Select the type of fluorescent light, from W white (4200°K)*, N neutral white (5000°K)*, and D daylight (6500°K)*.
	Tungsten Light	For taking pictures under tungsten light bulbs.
	Flash	For taking pictures using the electronic flash.
	Manual	For taking pictures by manually adjusting the white balance.

* The color temperature (°K) is estimated. This does not indicate precise colors. See page 143 for color temperature.

1 Set the mode dial to **WB**.

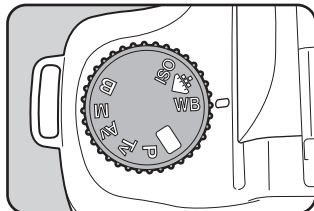

2 Select the white balance with the Av dial.

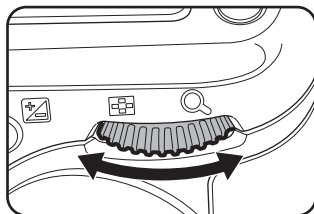

3 Confirm the white balance on the LCD panel.

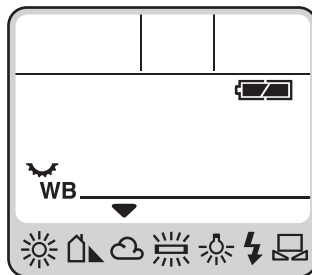

4 Set the mode dial to your desired capture mode.

4

Shooting Functions



- See page 142 for manual adjustment method.
- Pressing the green button while setting the white balance will make the white balance revert to the default value (**AWB**).

You can choose the part of the screen to use for measuring brightness and determining exposure. Multi (16)-segment metering, center-weighted metering or spot metering mode can be selected in this camera.

Using the Multi(16)-Segment Metering

The scene in the viewfinder is metered in 16 different zones as shown in the illustration when using the multi-segment metering. This mode automatically determines what level of brightness is in which portion.

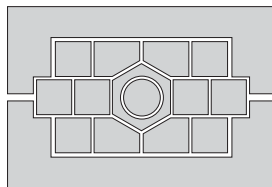

- 1 Rotate the metering mode select lever to set the white index to .**

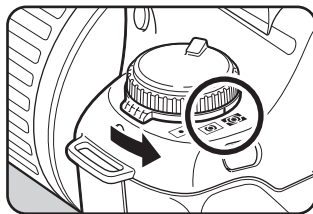



The center-weighted metering mode is automatically set even if you select the multi-segment metering mode when using a lens other than an FA J, FA, F or A lens. (the lens can only be used when a custom function is set to permit shutter release with a position other than aperture A.)

Using the Center-Weighted Metering

Metering is weighted at the center of the screen. Use this metering when you want to compensate the exposure by experience, instead of leaving it to the camera.

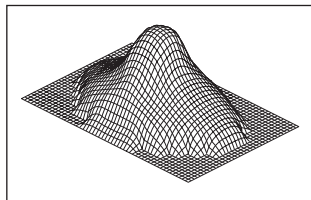
The illustration shows that sensitivity increases as the pattern height increases (center). This mode does not automatically compensate for backlit scenes.



- 1 Rotate the metering mode select lever to set the white index to .

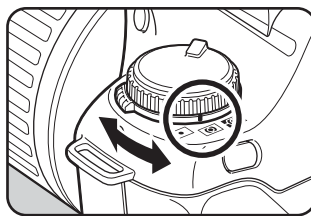

Using the Spot Metering

With spot metering, brightness is measured only within a limited area at the center of the screen as shown in the illustration. You can use AE lock in combination when the subject is extremely small and proper exposure is difficult to obtain. (p.69)

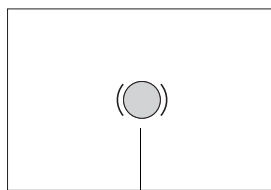

Spot metering zone

- 1 Rotate the metering mode select lever to set the white index to .

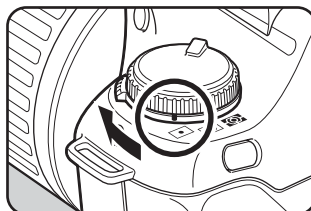

This camera has six capture modes available: green program AE mode, **P** (program) mode, **Tv** (shutter-priority) mode, **Av** (aperture-priority) mode, **M** (manual) mode and **B** (bulb) mode.

Using the Green Program AE mode

Shutter speed and aperture are set automatically according to the program line, for taking pictures at the proper exposure.

- 1 Set the mode dial to .

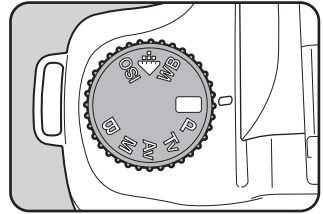

AE lock shooting (p.69), auto bracket shooting (p.82), multiple exposure shooting (p.84), and EV compensation (p.79) are not available in green program AE mode.

Using the P (Hyper Program) mode

Shutter speed and aperture are automatically set according to the program line for taking pictures at the proper exposure. You can also use the Tv dial and Av dial to change the shutter speed and aperture while keeping the proper exposure (Hyper program).

1 Set the mode dial to **P**.

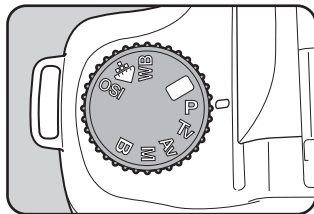

2 Confirm the shutter speed and aperture value in the viewfinder or on the LCD panel.

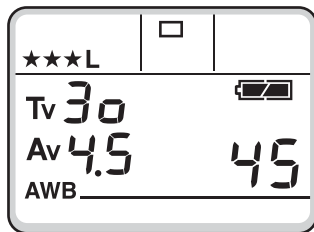

- Set the aperture to the **A** position while holding down the auto-lock button when using a lens with an aperture ring.
- You can set a custom function to change the program line used. See page 115 for setting Custom Functions.
- You can set a custom function to compensate the sensitivity automatically to obtain the proper exposure when the conditions set are not providing proper exposure. See page 115 for setting Custom Functions.

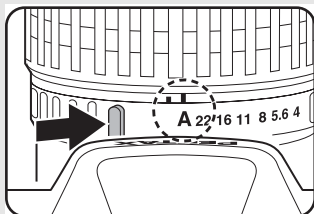

Hyper Program

• To change shutter speed

The camera switches to shutter speed-priority AE when you turn the **Tv** dial in the **P** (Hyper Program) mode.

- Shutter speed can be set to a value within the range appropriate for the aperture value.
- The aperture values on the LCD panel and in the viewfinder will flash when the brightness changes and the aperture value falls outside the appropriate range.
- The camera returns to Hyper Program mode when you press the green button.

• To change aperture value

The camera switches to Aperture-priority AE when you turn the **Av** dial in the **P** (Hyper Program) mode.

- Aperture can be set only to a value within the range appropriate for the shutter speed value.
- The shutter speeds on the LCD panel and in the viewfinder will flash when the brightness changes and the shutter speed value falls outside the appropriate range.
- The camera returns to Hyper Program mode when you press the green button.

Using the Tv (Shutter-priority) mode

The appropriate aperture value is automatically set by the camera for a proper exposure to match the brightness of the subject when the shutter speed is selected.

This mode is suitable for freezing the action with a faster shutter speed or capturing a flowing dynamic image with a slower shutter speed. See page 136 for the effect of shutter speed.

1 Set the mode dial to Tv.

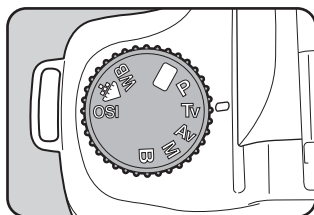

2 Select the shutter speed with the Tv dial.

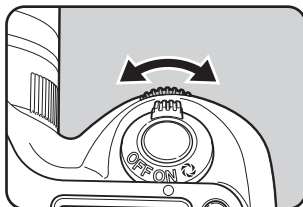

3 Confirm the shutter speed and aperture value in the viewfinder or on the LCD panel.

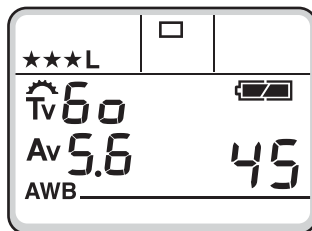



- Set the aperture to the **A** position while holding down the auto-lock button when using a lens with an aperture ring.
- The shutter speed is displayed on the LCD panel whenever the camera is on.
- You can set a function to enable noise reduction processing when taking pictures at a slow shutter speed. See page 115 for setting Custom Functions.
- You can set a custom function to automatically compensate the sensitivity to obtain the proper exposure, when the conditions set are not providing proper exposure. See page 115 for setting Custom Functions.

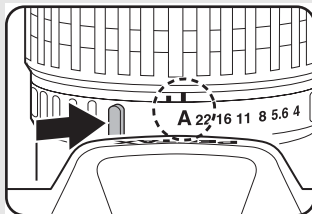

Exposure Warning

If the subject is too bright or too dark, the aperture value will blink in the viewfinder and on the LCD panel. When the subject is too bright, choose a faster shutter speed. If it is too dark, choose a slower shutter speed. When the shutter speed indication stops blinking, you can take the picture with proper exposure.

If both the shutter speed and aperture value are blinking, this indicates being out of metering range, unable to obtain the proper exposure even if the shutter speed is adjusted.

Use an ND (Neutral Density) filter if the subject is too bright. Use a flash or faster sensitivity if it is too dark.

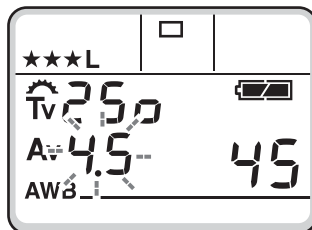

Using the Av (Aperture-priority) mode

The shutter speed is automatically set by the camera for a proper exposure to match the brightness of the subject when the aperture value is selected. This mode is ideal for shooting landscapes with increased depth of field, or a portrait against a blurred background. See page 136 for the effect of aperture.

- 1 Set the mode dial to Av.

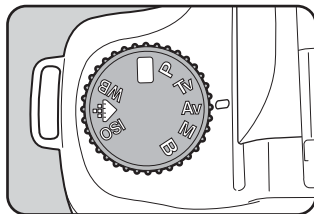

- 2 Select the aperture value with the Av dial.

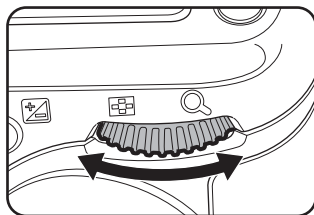

- 3 Confirm the shutter speed and aperture value in the viewfinder or on the LCD panel.

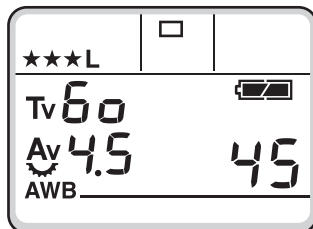



- Set the aperture to the **A** position while holding down the auto-lock button when using a lens with an aperture ring.
- The aperture is displayed on the LCD panel whenever the camera is on.
- You can set a custom function to compensate the sensitivity automatically to obtain the proper exposure, when the conditions set are not providing proper exposure. See page 115 for setting Custom Functions.

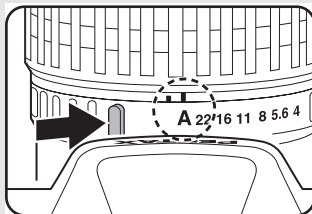

Exposure Warning

If the subject is too bright or too dark, the shutter speed will blink in the viewfinder and on the LCD panel. When too bright, set the aperture smaller (larger number), and when too dark, open the aperture further (smaller number). Once blinking stops, you can take the picture.

If both the shutter speed and aperture value are blinking, this indicates being out of metering range, unable to obtain the proper exposure even if the aperture is adjusted.

Use an ND (Neutral Density) filter if the subject is too bright.

Use a flash or faster sensitivity if it is too dark.

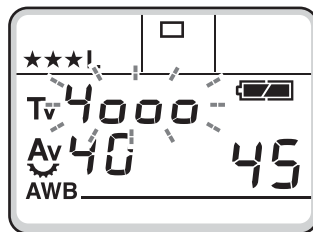

Using the M (Hyper manual exposure) mode

This mode is a convenient for taking pictures using the same shutter speed and aperture setting combination or taking intentionally under-exposed (darker) or over-exposed (brighter) photographs.

1 Set the mode dial to M

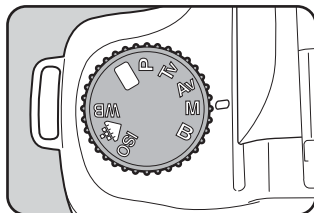

2 Press the green button

Shutter speed and aperture are changed automatically to achieve the proper exposure setting.

From this point, you can use the Tv dial or Av dial to change exposure values manually and then take a picture.

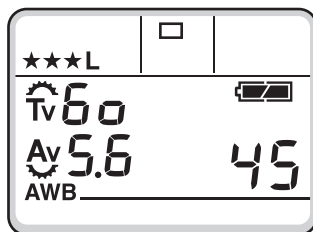
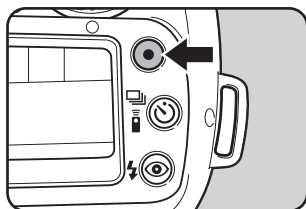

- Hold down the auto-lock button while setting the aperture to the A position when using a lens with an aperture ring.
- When pressing the green button to get the proper exposure setting, how shutter speed and aperture values are determined will change depending on the "Green Button in Manual" in the custom function menu.

P : The proper exposure setting is determined based on the program mode selected in the custom settings menu.

Tv : The aperture value is fixed to the point when the green button is pressed and then the shutter speed that will produce the proper exposure is determined.

Av : The shutter speed is fixed to the point when the green button is pressed and then the aperture value that will produce the proper exposure is determined.

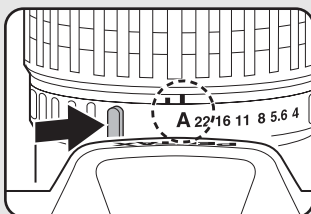

How to read the viewfinder bar graph

In **M** (Hyper manual exposure) mode, a bar graph appears in the viewfinder. If the ● are at the center of the bar, it indicates correct exposure. If the ● are on the negative end of the bar graph, it indicates under exposure. If they are on the positive end, it indicates over exposure. If the exposure setting exceeds the bar graph display limit, the ⊕ or ⊖ will blink.



- The shutter speed and aperture value are displayed on the LCD panel whenever the camera is on.

Exposure Warning

If the subject is too bright or too dark, both the shutter speed and aperture value will blink in the viewfinder and on the LCD panel to indicate being out of metering range. Adjusting the shutter speed and aperture will not attain proper exposure. Use an ND (Neutral Density) filter or select a darker subject if the subject is too bright. Select a brighter subject or use a flash if it is too dark.

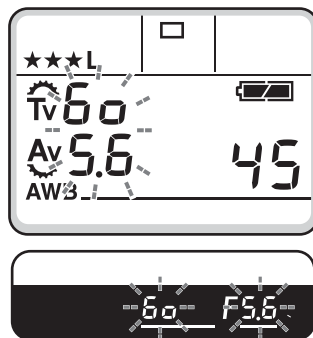

Combining with AE-L

You can use the AE-L button (p.69) to memorize the exposure value in Hyper Manual mode. In this state, the shutter speed and aperture value combination is changed, with the exposure value said as is, when you change either the shutter speed or the aperture value.

Ex) If you press AE-L with the shutter speed set to 1/125 seconds and the aperture set to f/5.6, using the Tv dial to change the shutter speed to 1/30 seconds will result in the aperture value automatically changing to f11.

Using the B (Bulb) mode

This mode is useful for the long exposures required for shooting night scenes and fireworks.

1 Set the mode dial to **B**.

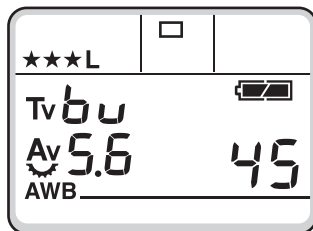
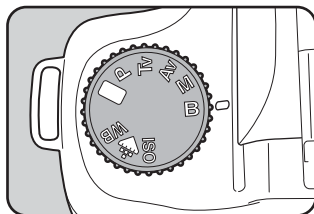

- Use a steady tripod to prevent camera shake and use the optional Cable Switch CS-205 when using this mode.
- With the remote control shooting mode, the shutter remains open as long as the optional remote control's shutter release button is held down.
- You can set whether or not to perform noise reduction in the Custom Function settings.

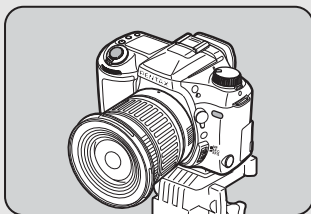

About the AE-L (AE Lock)

AE Lock is a function that memorizes the exposure prior to taking the picture. Use this when the subject is too small or backlit and a proper exposure setting cannot be obtained.

1 Press the AE lock button.

The camera memorizes the exposure (brightness) at that instant.

Press it again to disengage.

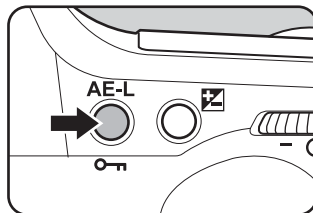

- ✱ is displayed in the viewfinder while the AE lock is engaged.
- The exposure remains in memory for twice as much time as the metering timer after releasing the AE lock button. The exposure remains locked as long as the AE lock button is kept pressed or the shutter release button is kept pressed halfway.
- You will hear a beep when the AE lock button is pressed. The beep can be turned off. (p.119)
- AE lock is not available when the exposure mode is set to **B** (Bulb) mode.
- When the exposure mode is set to **P** (program) mode, you can use a Hyper program while the AE lock is engaged.
- The combination of shutter speed and aperture value changes depending on the zooming position even while the AE lock is engaged when using a zoom lens for which maximum aperture varies depending on the focal length. However, the exposure value does not vary, and therefore the picture is taken at the brightness level set by the AE lock.
- The exposure value set when you press the AE lock button is saved when the exposure mode is set to **M** (Hyper manual exposure) mode. In this state, the shutter speed and aperture value combination is changed, with the exposure value said as is, when you change either the shutter speed or the aperture value.

Autofocus

The camera adjusts the focus automatically. There are two autofocus modes. When you press the shutter release button halfway, **AF.S** (Single mode) locks the focus and **AF.C** (Continuous mode) adjusts the focus continuously. (p.70, 71)

Manual focus

You can adjust the focus manually. (p.72)

Selecting the focus point

You can set the camera to automatically select the focus point, select a specified position or the center position within the viewfinder. (p.74)

The following three methods are provided for adjusting focus.

Using the AF.S Autofocus (Single mode)

- 1 Set the focus mode lever to **AF.S**.

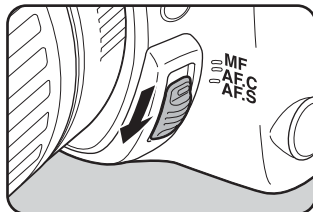

2 Look through the viewfinder and press the shutter release button halfway down to focus on the subject.

The focus indicator [●] lights up in the viewfinder when the subject is in focus.

(The subject is out of focus when it is blinking.)

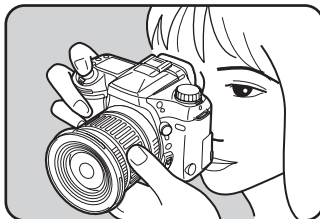

- The focus is locked while [●] is lit (focus lock). To focus on another subject, take your finger off of the shutter release button first.
- The shutter cannot be released until the subject is in focus in **A.F.S** (single mode). If the subject is too close to the camera, move back and take the picture. Set the focus manually when the subject is difficult to focus. (see page 78)

Using the AF.C Autofocus (Continuous mode)

1 Set the focus mode lever to **A.F.C.**

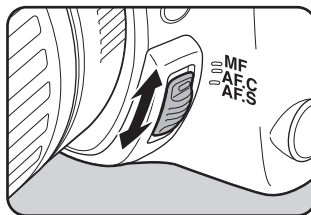

2 Look through the viewfinder and press the shutter release button halfway down to focus on the subject.

The focus indicator [●] lights up in the viewfinder when the subject is in focus.

(The subject is out of focus when it is blinking.)

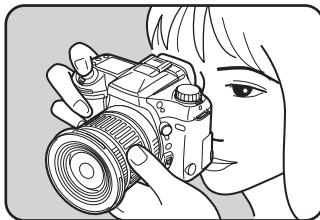

- The camera switches to predictive AF mode automatically when a moving subject is detected in **AFC** (continuous mode).
- The shutter can be released even when the subject is out of focus in **AFC** (continuous mode).

Manual Focus

When you adjust the focus manually, you can either check with the focus indicator in the viewfinder or use the viewfinder matte field to adjust focus.

Using the focus indicator

You can manually adjust the focus using the focus indicator.

1 Set the focus mode lever to MF.

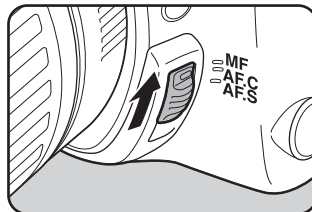

- 2** Look through the viewfinder and press the shutter release button halfway and turn the focusing ring to adjust focus on the subject.

The focus indicator [●] lights up and you will hear a double beep when the subject comes into focus.

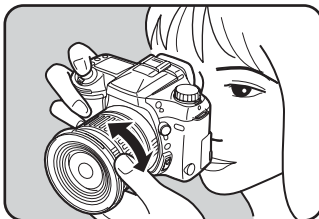

- Use the viewfinder's matte field as described below when the subject is difficult to focus (see p.78) and the focus indicator will not stay lit.
- The beep can be turned off. (p.119)

Using the viewfinder matte field

- 1** Set the focus mode lever to **MF**.

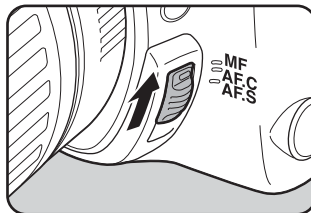

- 2** Look through the viewfinder and turn the focusing ring until the subject looks sharp on the screen

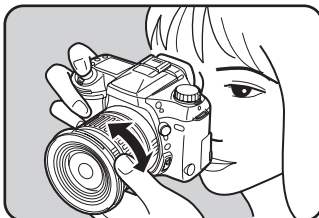

Selecting the focus points

There are 11 focus points in the autofocus frames. You can select the focus points to use depending on the scene you are shooting.

Setting the focus point mode to AUTO

The camera selects the optimum focus point position even if the subject is not centered.

1 Set the focus point select dial to .

The area in the autofocus frame is the range available for autofocus.

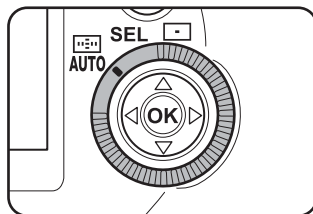

- The focused point is superimposed in red in the viewfinder when the shutter release button is pressed halfway down. The superimpose function can be canceled using a custom function. See page 115 for setting Custom Functions.
- The focus point is fixed to the center position regardless of this setting with lenses other than FA J, FA, F lenses.

Selecting the Focus Point

There are 11 focus points in the autofocus frames. If the camera does not select the desired focus point in Auto mode, you can select the desired focus point manually.

1 Set the focus point select dial to **SEL**.

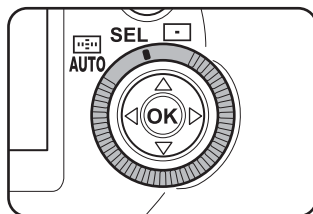

- 2** Look through the viewfinder and check where you want to focus.

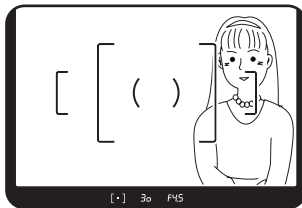

- 3** Use the four-way controller [▲ ▼ ◀ ▶] to select the desired focus point.



The selected focus point is superimposed in red in the viewfinder.

Check the set focus point with the focus points indicator at the bottom of the viewfinder when you have trouble seeing the superimposed focus point because of the backlit or other conditions.



- Set the focus point select dial to  to cancel the selected focus point and return to automatic setting.
- The focus point is fixed to the center position regardless of this setting with lenses other than FA J, FA, F lenses.

Fixing the Focus Point on the Center

- 1** Set the focus point select dial to .

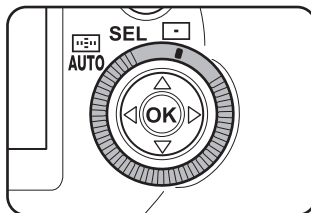

2 Press the shutter release button halfway.

Only the center is focused where the focus point is superimposed.

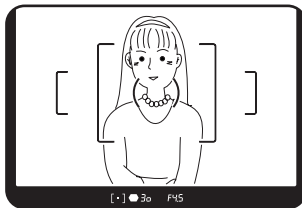

Set the focus point select dial to to cancel the selected focus point and return to automatic setting.

Focus lock

4

If the subject is beyond the range of the focus points area, the camera cannot automatically focus on the subject. In this situation, you can aim the focus point on the subject, use focus lock, then recompose the picture. You can take pictures in Focus lock mode when the focus mode is set to **A.F.S** (Single Mode).

1 Frame the desired composition for your picture in the viewfinder.

You can use focus lock when the subject you wish to focus on is not within the focus point area.

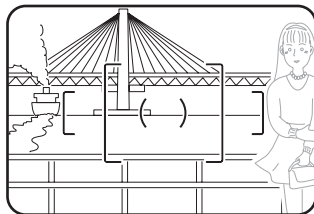

(Example)

The person is out of focus and the background is focused instead.

2 Aim the center of the viewfinder over the subject, then press the shutter release button halfway down.

The focus indicator [] lights up and you will hear a beep when the subject comes into focus. (If it is blinking, the subject is out of focus.)

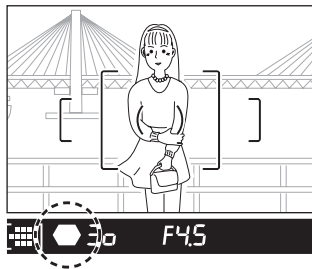

3 Lock the focus.

Keep the shutter release button pressed halfway. The focus will remain locked.

4 Re-compose the picture while keeping the shutter release button pressed halfway down and press the shutter release button fully to take the picture.

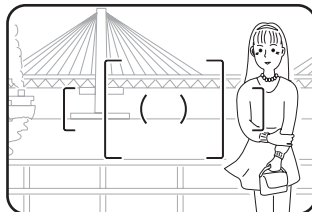

- The focus is locked while the focus indicator [●] is lit.
- Turning the zooming ring in focus lock mode may cause the subject to be out of focus.
- The beep can be turned off. (p.119)

Autofocus illuminator

When the flash is up in **A.F.S** (single mode) where the subject in dark area, pressing the shutter release button halfway will automatically fire the built-in flash several times, enabling the autofocus to focus on the subject.

Hard-to-Autofocus Subjects

The autofocus mechanism is not all-powerful. Subjects which may not focus are listed below. These also apply to manual focusing using the focus indicator [●] in the viewfinder.

For any of these, set the focus mode switch to **MF** and use the manual focus mode to focus on the subject with the aid of the matte field in the viewfinder.

- a) Extremely low-contrast subject such as a white wall in the focus points range.
- b) Subjects which don't reflect much light within the focus points range.
- c) Subjects that are moving extremely fast.
- d) Powerfully reflected light or strong backlight (subjects with extremely bright backgrounds).
- e) If vertical or horizontal line patterns appear within the focus points range.
- f) Multiple subjects in the foreground and background within the focus points range.

It may not be in focus even if the focus indicator [●] is lit.

AF Button

You can activate autofocus by pressing the AF button and press the shutter button to take a picture.

This functions the same as when you press the shutter button halfway down. Once you press the AF button during **A.F.S** (Single Mode) to adjust the focus, focus lock will operate while you hold down the button.

The camera will continue to adjust the focus while you hold down the button in **A.F.C** (Continuous Mode).

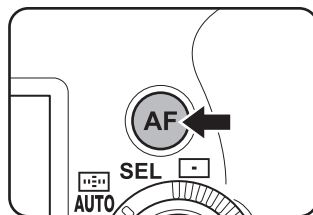

This allows you to deliberately over-expose (brighten) or under-expose (darken) your picture. The exposure compensation range is -3 EV to +3 EV in 0.5 EV or 0.3 EV steps.

- 1 Turn the Tv dial to set the desired compensation value while holding down the Exposure compensation button.**

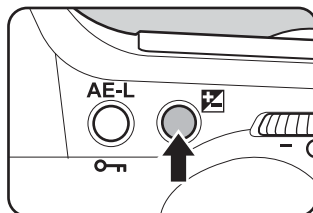

- 2 Confirm the compensation value in the viewfinder or on the LCD panel.**

The set value and  are displayed during compensation.

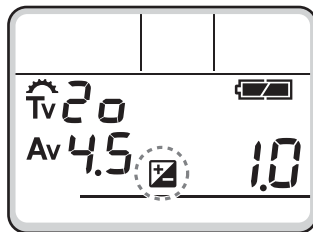

How to read the viewfinder bar graph

If the  are on the negative side of the bar graph, it indicates under-exposure. If they are on the positive side, it indicates over-exposure. One dot on the bar graph indicates 0.5 step (0.5 EV).



- The exposure compensation cannot be canceled by turning the camera off, or by setting any other exposure mode.
- Press the green button to reset the exposure compensation value to 0 while pressing the exposure compensation button.
- You can set a custom function to allow setting exposure compensation by 0.3 steps (EV). See page 115 for setting Custom Functions.



Exposure compensation is not available when the exposure mode is set to green program AE mode, **M** (metered manual exposure) mode or **B** (bulb) mode.

You can use the zoom lens to freely change the size of your chosen subject. Adjust it to the desired size and take the picture.

- 1 Turn the zoom ring clockwise for telephoto and counterclockwise for wide angle.**

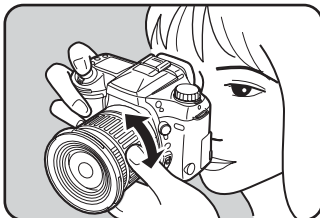

- The smaller the number shown on the zoom scale ring, the wider the angle. The larger the number, the more magnified the image appears.
- Power Zoom, Image Size Tracking, Zoom Clip, and Auto Zoom Effect are not compatible with this camera.

Auto Bracketing

You can capture three consecutive images at different exposures. The first frame is exposed with no compensation. The second frame is under-exposed and the third frame is over-exposed.

You can set the negative or positive exposure compensation step to be 1/2EV (± 0.5 , ± 1.0 , ± 1.5) or 1/3EV (± 0.3 , ± 0.7 , ± 1.0), using “Exposure setting steps” in custom functions.



Normal exposure



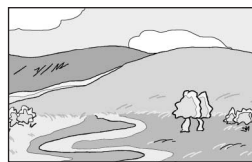

Under-exposure

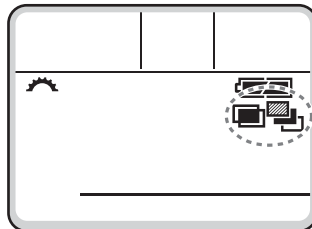
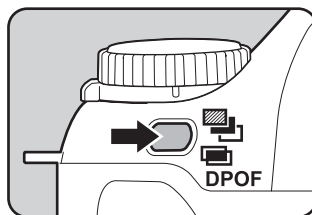

Over-exposure

- 1 Press the multiple exposure / auto bracket button until  appears on the LCD panel.



- 2 Turn the Tv dial to select  while holding down the multiple exposure / auto bracket button.

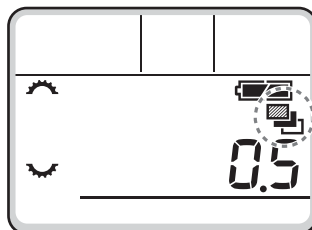

- 3 Turn the Av dial to set the exposure compensation step while holding down the multiple exposure / auto bracket button.**

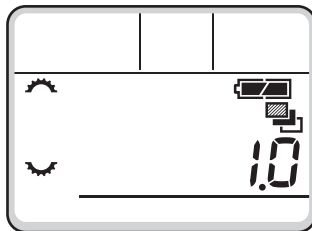

- 4 Hold down the shutter release button.**

Three consecutive pictures will be taken, the first with no compensation, the second with negative compensation, and the third with positive compensation. The mode returns to the single-frame drive mode automatically after the third picture is taken.



- By combining this function with consecutive shooting mode, you can take consecutive auto bracketing shots for as long as you keep the shutter release button pressed.
- The focus is locked in the first frame position when the focus mode lever is set to **A.F.S** (single).
- The focus is adjusted for each shot when the focus mode lever is set to **A.F.C** (continuous). However, note that the shutter will release even if the focusing is not complete.
- The auto bracketing exposure setting will remain effective for twice as much time as the metering timer (initial value 20 seconds) when you release your finger from the shutter release button during auto bracketing, and you can take the next picture at the next compensation step. In this case, auto focusing works for each frame. After about twice as much time as the metering timer (initial value 20 seconds), the camera returns to settings for taking the first picture.
- You can combine this function with the built-in flash or external flash (TTL and P-TTL auto only) to change only the flash light output consecutively. However, when using an external flash, holding the shutter release button down to take three continuous frames may cause the second and third frame to be taken before the flash is fully recharged. Always take one frame at a time after confirming that charging is complete.
- You can change the auto bracketing sequence using a custom function. See page 115 for setting Custom Functions.



Taking only over-exposed or under-exposed pictures

You can use the auto bracketing mode for only under-exposure or over-exposure shots by combining the operation with exposure compensation (p.79). The auto bracketing is performed in both cases on the basis of the specified exposure compensation value.

Multiple Exposure Shooting

You can overlap multiple images to take one picture.

For example, you can take composite pictures such as a night scene with a bright moon superimposed.

- 1 Press the multiple exposure / auto bracket button until   appears on the LCD panel.

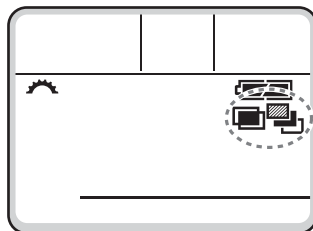
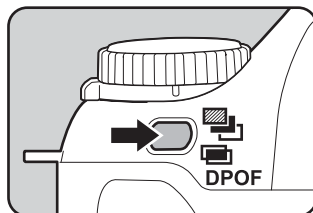

- 2 Turn the Tv dial to select  while holding down the multiple exposure / auto bracket button.

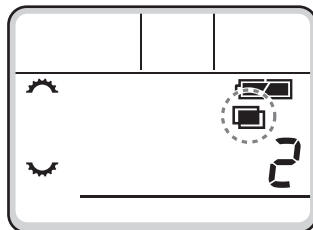

- 3 Use the Av dial to set the number of multiple exposures while holding down the multiple exposure / auto bracket button.

Here, as an example, the number is set to 2 (two).

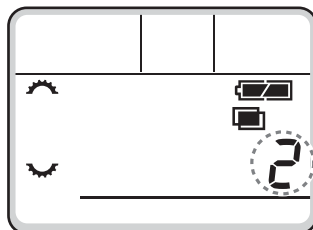

- 4** Release the finger from the multiple exposure / auto bracket button and press the shutter release button to take the first image.

The first image is captured, and is displayed on the LCD monitor for instant review.



- 5** Press the shutter release button to take the superimposed image.

The composite image is displayed on the LCD monitor.



- The  on the LCD panel disappears and multiple exposure mode is cancelled when the picture is taken.
- You can delete the first image by pressing the delete button while the delete screen is displayed.
- Repeat step 5 to take three or more.
- The maximum number of frames is 9 (nine) at one time.

Using the built-in flash

When you use a flash in low light or backlit conditions, manually pop up the built-in flash before taking the picture.

Vignetting may occur depending on the lens being used and the capture conditions. We recommend to take a test shoot to confirm this. Also refer to Page 140 “F, FA and FA J Lenses Compatibility with the Built-in Flash”.

1 Press the flash pop-up button to raise the flash.

The flash pops up and starts charging automatically.

When flash is fully charged, ⚡ appears in the viewfinder and on the LCD panel.

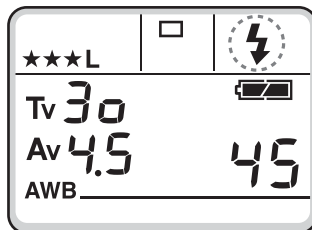
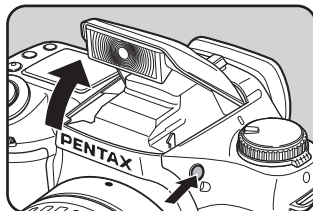

2 Press the flash mode button to select a flash mode.

See page 87.

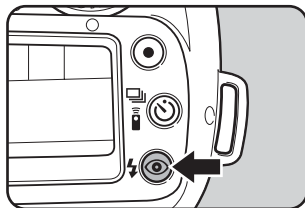

3 Press the shutter release button fully and the flash discharges.

- 4** Push down on the portion in the illustration to retract the flash.

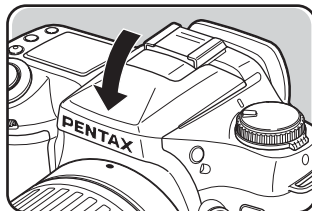

Setting Flash Modes

- 1** Press the flash mode button to select a flash mode.

The flash mode on the LCD panel cycles as shown in the chart with each press of the button.

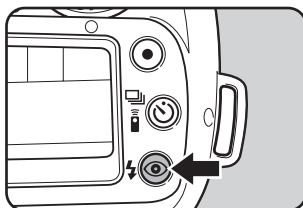

Flash modes for each capture mode

Flash modes differ by capture mode. See below for the flash modes corresponding to each capture mode. (The indications shown are with the built-in flash popped up.)

- Green program AE mode



Automatic flash



Red-eye reduction
automatic flash

• P (program) mode

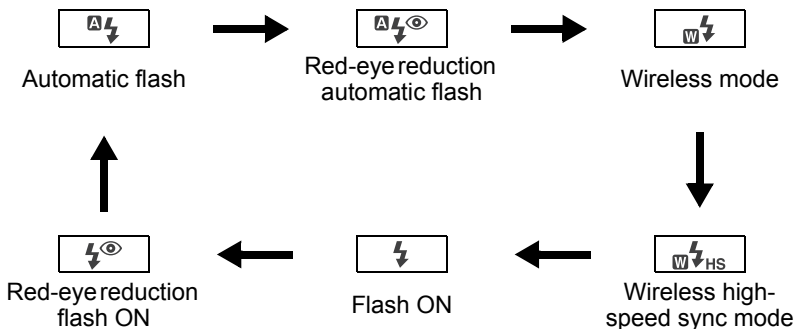

• Tv (Shutter priority) mode / Av (Aperture priority) mode M (Manual exposure mode) / B (Bulb) mode

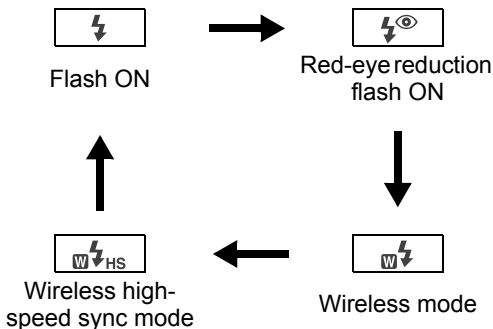

Red-eye Reduction

This camera has a red-eye reduction function, which reduces red-eye by discharging the flash twice. When  is displayed on the LCD panel, the pre-flash is discharged just before the shutter is released. This reduces the pupil diameter. Then the main flash is discharged while the pupils are smaller, reducing the red-eye effect.



- If red-eye reduction is used when the AF360FGZ or AF500FTZ, etc. is set as a slave unit or wireless, the preflash for red-eye reduction will trigger the external flash to fire. Do not use red-eye reduction when using a slave unit.
- The red-eye reduction feature works even when only an external flash is used. See page 97.

About Red-eye Phenomenon

Shooting portraits with a flash in a dark environment often results in eyes looking reddish in the photograph. This phenomenon, commonly known as “Red-Eye”, is caused by the reflection of the electronic flash in the retina of the eye. It can be reduced by taking a picture in brighter light or by shooting with a wider-angle lens at a closer distance. When using an external flash, it may also help to position the flash as far away from the camera as possible.

Flash photography distance

As a rule of thumb, the distance for using the built-in flash (which varies with the lens used) is within about four meters of the subject. (With sensitivity 400)





- The flash effective range does not come closer than 0.7m (2.6ft), even if the lens aperture is very small. The exposure will not be properly controlled when taking a picture closer than 0.7m. Note that this can also cause and you will see vignetting in the picture corners.
- To calculate the flash photography distance from the aperture size, see p.139.

Flash Recommended indicator

The flash recommended indicator [] in the viewfinder and on the LCD panel will blink to recommend that you use the flash when you attempt to take a picture in low light and backlight condition.



-  will blink only in backlit conditions when the capture mode is set to **Tv** (shutter priority) mode or **M** (manual exposure) mode.
-  stops blinking when the flash is fully charged.
-  will not appear in Bulb mode.

Daylight-Sync Shooting

In daylight conditions, the flash will eliminate the shadow when a portrait picture is taken with a person's face cast in shadow.

Daylight-sync shooting is the same as normal shooting with a flash.

• Taking pictures

- 1 Press the flash pop-up button.
- 2 Confirm that the flash mode is set to Flash ON.
- 3 Confirm that the flash is fully charged.
- 4 Take the picture.



- It may be over-exposed when the background is too bright.
- Press the flash button and turn off **A** on the LCD panel when shooting with daylight-sync. The flash may not discharge when taking a daylight-sync photograph with **A** displayed on the LCD panel (**A** on the LCD panel cannot be turned off in the green program AE mode.)



Without Daylight-Sync



With Daylight-Sync

Using the flash in each capture mode

Using Tv (Shutter priority) Mode

- When taking a moving subject, you can use the flash to change the blur effect.
- Any desired shutter speed 1/150 sec. or slower can be set for taking a flash photograph.
- The aperture automatically changes according to the ambient brightness.

Using Av (Aperture-priority) Mode

- You can set the desired aperture to take a flash photograph when you want to change the depth of field or shoot any far away subject.
- The shutter speed automatically changes with the ambient brightness.
- The shutter speed shifts automatically anywhere from 1/150 sec. to a slow shutter speed that does not cause camera shake. The slowest shutter speed depends on the focal length of the lens in use.
- The shutter speed is fixed at 1/150 sec when any lens other than FA J, FA or F is used.

Slow-Speed-Sync Mode

It is possible to balance the exposure of a foreground subject in a low light background by using the flash to properly expose the foreground subject and a slow-shutter-speed to expose the low light background.

• Using M (Hyper manual exposure) Mode

- 1 Set the exposure mode to **M**(Hyper manual exposure) mode
- 2 Set the shutter speed (under 1/150 sec) and aperture value to obtain correct exposure.
- 3 Press the flash pop-up button to activate the flash.
- 4 Take the picture.



The flash can be raised at any time before taking the picture in Hyper manual exposure mode.

• Using Tv (Shutter priority) Mode

- 1 Set the exposure mode to **Tv** (shutter priority) mode.
- 2 Use the Tv dial to set the desired shutter speed.
- 3 Press the flash pop-up button to activate the built-in flash.
- 4 Take the picture.



- If the aperture value blinks when the shutter speed is set, the background will not be exposed correctly. Adjust the shutter speed so that the aperture value stops blinking.
- If the flash is popped up before setting the shutter speed, the background will not be exposed correctly.
- The picture will be blurred when the subject is not stop moving, use of a tripod is recommended to prevent camera shake.
- You can use slow-speed-sync shooting by performing the same operation in Hyper program **Tv** (shutter priority) mode.
- Slow-speed-sync shooting can also be performed with an external flash.

Using an External Flash

Using the optional external flash AF360FGZ enables a variety of flash modes, such as P-TTL automatic flash mode, TTL auto-flash mode, high-speed flash sync mode, and wireless mode. Available functions differ by the external flash being used. See the chart below for details.

CAMERA FUNCTION \ Flash	Built-in Flash	AF360FGZ	AF500FTZ AF330FTZ	AF400FTZ AF240FT
Red-eye reduction flash	○	○	○	×
Automatic flash discharge	○	○	○	○
After the flash is charged, the camera automatically switches to the flash sync speed.	○	○	○	○
Aperture is set automatically in the Hyper Program and Shutter-Priority AE Modes	○	○	○	○
Flash confirmation in the viewfinder	×	○	○	○
P-TTL auto flash* (appropriate sensitivity: 200 to 3200)	○*1	○*1	×	×
TTL auto flash* (appropriate sensitivity: 200 to 800)	○*2	○*2	○	○
Slow-speed sync	○	○	○	○
Autofocus illuminator	○	○	○	○
Trailing-shutter-curtain sync*3 flash	○*4	○	○	○
Contrast-control-sync flash*3 mode	×	○	○	×
Slave flash	×	○	○	×
Multiple flash	×	×	○*5	×
High-speed flash sync	×	○	×	×
Wireless flash	×	○	○*5	×

*1 When using FA J, FA, F or A lens.

*2 When a lens used in position other than aperture A.

*3 The shutter speed will be 1/60 sec. or slower.

*4 It can be combined with AF360FGZ / AF500FTZ / AF330FTZ or AF400FTZ / AF240FT flash for trailing-shutter-curtain sync flash.

*5 Not available with AF330FTZ.

About the LCD panel display for AF360FGZ

- The AF360FGZ will automatically convert the field angle differential between 35mm and the **istD* format resulting from the focal length of the lens you are using. (When using FA J, FA, or F lenses)
- Display the format size for **istD* during the exposure metering timer of the camera is turned on when combining the AF360FGZ with the **istD*. (It returns to a 35mm format display when the exposure metering timer is turned off.)

Lens used		AF 360 FGZ display
85mm	↔	58mm
70mm	↔	48mm
50mm	↔	34mm
35mm	↔	24mm
28mm	↔	19mm
24mm	↔	16mm
20mm	↔	13mm

4 Using P-TTL Auto Mode

Use this flash mode with the AF360FGZ flash unit. P-TTL auto flash, which pre-fires the flash using the 16-segment metering allows more precise control. P-TTL auto is available in wireless flash mode.

- 1 Remove the hot shoe cover and attach the flash unit.
- 2 Turn the external flash ON.
- 3 Set the flash unit mode switch to P-TTL auto.
- 4 Confirm that the flash is fully charged and then take the picture.



- P-TTL auto is available with the AF360FGZ flash unit only. The mode will be TTL auto when using a flash other than the AF360FGZ.
- The will light in the viewfinder when the flash is fully charged.
- For details such as operation method and effective distance, please read the external flash manual.
- The external flash discharges automatically when is lit in on the LCD panel. The flash does not discharge when the subject is bright enough, (therefore, it may not suitable for daylight-sync shooting).
- Never press the flash pop up button when any external flash unit is attached to the camera. The built-in flash will hit the external flash. If you want to use both at once, see page 97 for the connection method.

Using High-Speed Flash Sync Mode

With the AF360FGZ, you can discharge the flash to take a picture at a shutter speed faster than 1/150 second. High-speed flash sync can be used with the flash attached to the camera, or as a wireless.

• Using High-speed flash sync on the camera

- 1 Remove the hot shoe cover and attach the flash unit.
- 2 Set the mode dial to any exposure mode other than the green program AE mode or **B** (Bulb) mode.
- 3 Turn the external flash ON.
- 4 Set the flash unit sync mode switch to HS (high-speed flash sync.).
- 5 Confirm that the flash is fully charged and then take the picture.



- The will light in the viewfinder when the flash is ready (fully charged).
- High-speed flash sync is only available when the shutter speed is faster than 1/150 sec. For the **P** (Hyper Program) mode, rotate the **Tv** or the **Av** dial using the Shutter-priority mode or the Aperture-priority mode to make the shutter speed faster than 1/150 sec.
- High-speed flash sync is not available when the exposure mode is set to **B**.

• Using the AF360FGZ flash as wireless High-speed flash sync

- 1 Place the flash unit at the desired location.
- 2 Set the flash unit power switch to [WIRELESS]
- 3 Set the flash unit wireless mode switch to S (Slave).
- 4 Press the flash pop-up button to enable using the built-in flash.
- 5 Press the flash mode button until HS is displayed.



- The will light in the viewfinder when the flash is ready (fully charged).
- High-speed flash sync is only available when the shutter speed is faster than 1/150 sec.

Using Wireless Mode

With the AF360FGZ, you can discharge a flash without having a cord connection between the camera and flash unit. The High-speed sync mode can also be used with wireless flash.

- 1 Place the flash unit at the desired location.
- 2 Set the flash unit power switch to [WIRELESS]
- 3 Set the flash unit wireless mode switch to S (Slave).

- 4 Press the flash pop-up button to enable using the built-in flash.
- 5 Press the flash mode button until  is displayed.



- The  will light in the viewfinder when the flash is ready (fully charged).
- The AF360FGZ can be attached directly to the camera hot shoe and wireless mode can still be used with one or more additional AF360FGZ flashes.
- Set the AF360FGZ wireless slave mode to SLAVE 1.

Wireless flash control (P-TTL flash mode)

When the AF360FGZ is used for wireless flash, the following information is exchanged between the built-in flash and AF360FGZ before the flash is discharged.

- 1 Press the shutter release button completely.
- 2 The built-in flash discharges a pre-flash.
(the camera's flash mode is transmitted)
- 3 The external flash unit discharges a pre-flash.
(the subject's lighting condition is checked)
- 4 The internal flash unit discharges a pre-flash.
(the required flash output is transmitted to the external flash)
The built-in flash will discharge another pre-flash to transmit the flash duration time in HS (High-speed flash sync mode).
- 5 The AF360FGZ discharges the main flash.





- You can set a custom function to select how the built-in flash is to be used: either as an information controller for the external flash, or as a flash to affect the exposure. See page 115 for setting Custom Functions.
- Set the AF360FGZ in wireless slave mode to SLAVE 1.

Channel settings for wireless flash control

For wireless control, a channel (e.g. CH1) for the AF360FGZ must be set as follows.

Attach the AF360FGZ to the camera, turning on the camera and pressing the shutter release button halfway down to set the channel.



- The present channel is displayed for about 10 seconds when flash mode  or  is set.

Red-eye Reduction

As with the built-in flash, red-eye reduction is available using an external flash. This may not be available on some flashes and it may have any restrictions for usage conditions may be required. See the chart given on p.93.

Trailing-Shutter-Curtain Sync Flash

When using the built-in flash with an external flash that has a trailing-shutter-curtain sync flash function, the external flash is set to the trailing-shutter-curtain flash function, the internal flash will also use this mode. Confirm that both flash units are fully charged before shooting.

Using the built-in flash with an external flash

As shown in figure 1 below, attach the optional hot shoe adapter F_G to the camera hot shoe and an off-camera shoe adapter to the bottom of the external flash, and connect these with the extension cord F5P. The off camera shoe adapter F comes with a tripod screw for securing to your tripod.

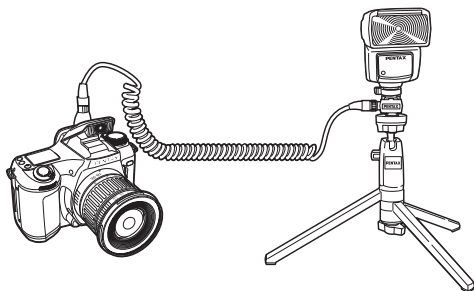

Fig. 1 When combining with the built-in flash

Discharging multiple flashes

To use two or more external flashes simultaneously, either use the same type of flashes as shown in the flash function chart on p.93, or use the following combinations: AF360FGZ / AF500FTZ / AF330FTZ and AF400FTZ / AF240FT. The built-in flash can be used with any type. Connect them as shown in Fig. 2 on the next page: Attach an off-camera shoe adapter F to the external flash and the hot shoe adapter F and connect the extension cord F5P to the off-camera shoe adapter F on the other external flash.

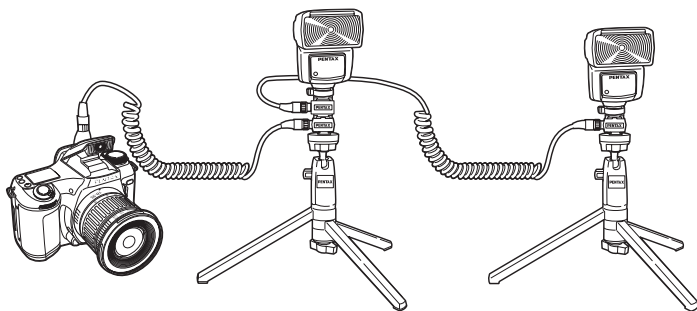

Fig. 2 When combining two or more external flashes



The AF500FTZ can be connected directly to the Extension cord F5P without the off-camera shoe adapter F.

4

Contrast-Control-Sync Flash

Using the dedicated external flash in combination with the built-in flash allows twin flash photography (contrast-control-synch flash photography). This is based on the difference between the amounts of light discharged from two units. Contrast control synch flash is possible with the combination of following flash units:

AF360FGZ, AF330FTZ, AF500FTZ and the built-in flash

- 1 Refer to page 97 for connecting the external flash off-camera.
- 2 Set the synch mode for AF360FGZ, AF330FTZ / AF500FTZ to the Contrast-Control-Synch mode.
- 3 Confirm that both the external flash and built-in flash are fully charged and then take the picture.



- For contrast control synch flash photography when using two external flashes, the flash set as the contrast control flash is flash 2, and the other external flash is flash 1. When using an external flash with the built-in flash, the built-in flash is flash 1, and the external flash is flash 2.
- Do not combine an accessory with a different number of contacts such as a "Hot Shoe Grip", as a malfunction may occur.
- The fastest flash synchronization speed is 1/60 second in the Contrast-Control-Synch mode.
- Combining with flashes from other manufacturers may cause equipment breakdown. We recommend using the PENTAX dedicated automatic flashes.

5 Playback Functions

Zoom Playback	100
Nine-Image Display	101
Deleting Images	102
Printing Service Settings (DPOF)	106

You can play back images magnified up to 12 times.

- 1 Press the **Playback** button and use the four-way controller (◀▶) to select an image.



- 2 Turn the **Nine-image display / Zoom display dial** clockwise.

The image is magnified (1×~12×). You can move the zoom position with the four-way controller during zoom display.

Turn the Nine-image display / zoom display dial counterclockwise to reduce the magnification.

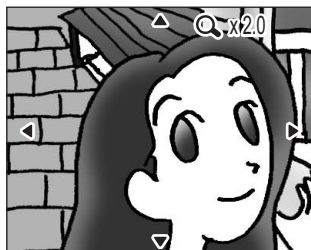
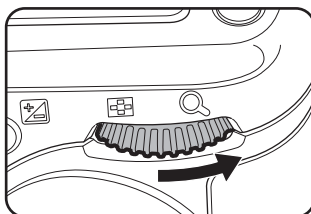

Press the **Playback** button or press the shutter release button halfway to return to capture mode.

You can display nine images on the LCD monitor at the same time.

- 1 Press the Playback button and use the four-way controller (◀▶) to select an image.**

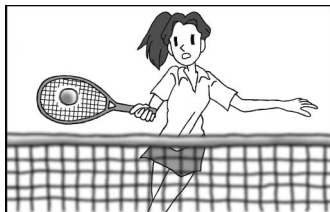

- 2 Turn the Nine-image display / Zoom display dial counterclockwise.**

Up to nine small images will be displayed at once.

Press the four-way controller (▲▼◀▶) to select an image.

If there are 10 or more images recorded, a scroll bar appears at the right of the screen. With an image selected in the bottom row, pressing the four-way controller (▼) displays the next nine images.

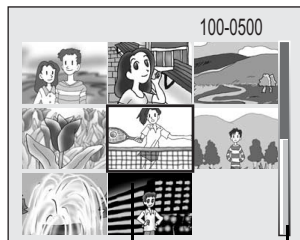
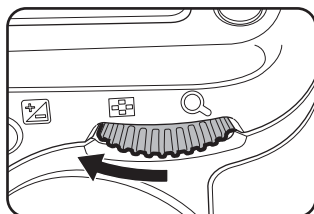

Selected image

scroll bar

5

Playback Functions



With the very last image selected, press the four-way controller (▼) to display the first nine images.

- 3 Turn the Nine-image display / Zoom display dial clockwise, or press OK.**

The selected image is displayed.

Deleting a Single Image

You can delete one image at a time.

- 1 Press the **Playback** button and use the four-way controller (◀▶) to select the image to delete.

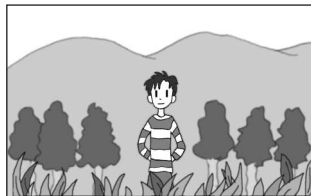

- 2 Press the **Delete** button to display the Delete screen.

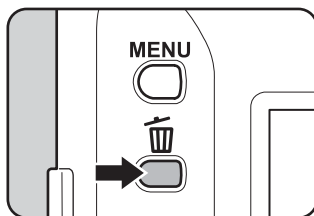

- 3 Select [Delete] with the four-way controller (▲).

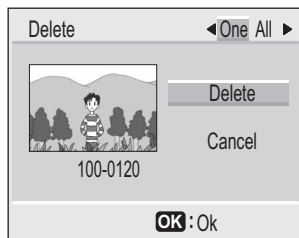

- 4 Press the **OK** button.

The image is deleted.

Deleting All Images

You can erase all saved images at once.



- Once deleted, images cannot be restored.
- Protected images cannot be deleted.

1 Press the Playback button.

2 Press the Delete button to display the Delete screen.

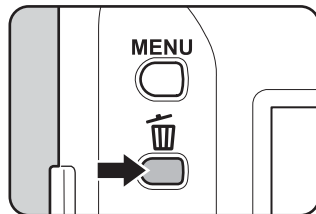

3 Select [All] with the four-way controller (◀▶).

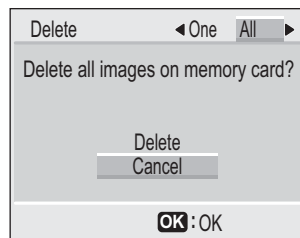

4 Press the four-way controller (▲) to select [Delete] and press OK.

All images are deleted.

Protecting Images from Deletion (Protect)

You can protect images from being accidentally erased.

- 1 Press the **Playback** button and use the four-way controller (◀▶) to select the image to protect.



- 2 Press the **Protect** button (⊞) to display the Protect screen.

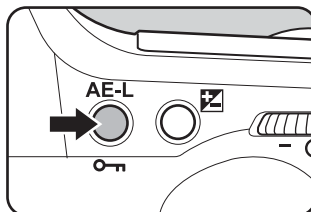

- 3 Select **[Protect]** with the four-way controller (▲).

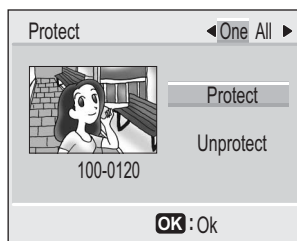

- 4 Press the **OK** button.

The selected image is protected.



- Select [Unprotect] in step 3 to cancel the Protect setting.
- The ⊞ symbol is displayed when playing back protected images.



Even protected images are deleted by formatting the CF card.

Protecting All Images

- 1 Press the **Playback** button.
- 2 Press the **Protect** button () to display the protect screen.

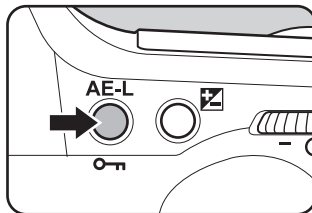

- 3 Select **[All]** with the four-way controller ().

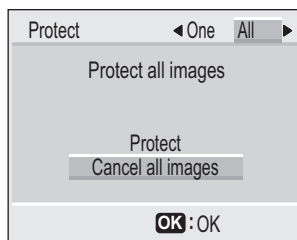

- 4 Press the four-way controller () to select **[Protect]** and press **OK**.

The images are protected.



Select **[Unprotect]** in step 3 to cancel the Protect setting on all of the images.



Even protected images are deleted by formatting the CF card.

Printing Service Settings (DPOF)

You can order conventional photograph prints by taking the CF card with recorded images to a store for a printing service. DPOF (Digital Print Order Format) settings allow you to specify the number of copies or to imprint the date.

Single Image Settings

Set the following items for each image.

- **Copies:** Set the number of prints up to 99.
- **Date:** Specify whether or not to imprint the date on the image.

- 1 **Press the Playback button and use the four-way controller (◀▶) to select the image to print.**



- 2 **Press the DPOF button to display the DPOF screen.**

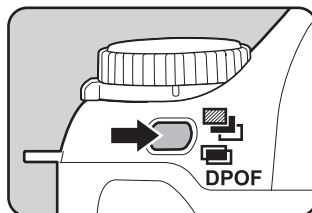

- 3 **Press the four-way controller (▼).**

The frame will move to “Copies”.

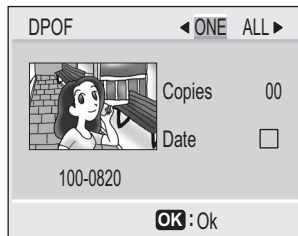

- 4** Press the four-way controller (◀▶) to specify the number of copies and press the four-way controller (▼).

The cursor will move to “Date”.



- 5** Press the four-way controller (◀▶) to select (on) or (off) for the date.

- The date will be imprinted.
- The date will not be imprinted.

- 6** Press the OK button.

Prints can be made according to the settings.



- If DPOF settings already exist for an image, the number of prints and the on / off date setting will be displayed.
- Set the number of prints to 0 and press the OK button to cancel DPOF settings.



- Some printers or printing equipment at the photo processing lab may not imprint the date even when the DPOF setting is set.
- DPOF setting is not applied to the Raw data images.

Settings for All Images

You can set printing service settings for all images.

1 Press the **Playback** button.

2 Press the **DPOF** button to display the DPOF screen.

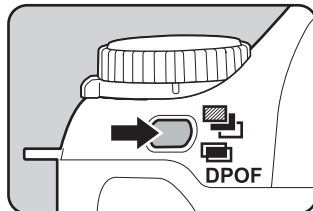

3 Press the four-way controller (◀▶) to select [All] and press the four-way controller (▼).

The frame will move to “Number of Copies”.

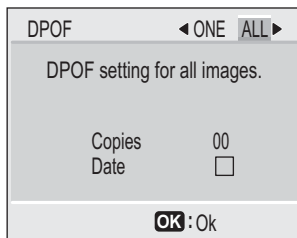

4 Press the four-way controller (◀▶) to select the number of copies and press the four-way controller (▼).

The cursor will move to “Date”.



You can set the number of prints up to 99.

5 Press the four-way controller (◀▶) to select (on) or (off) for the date.

- The date will be imprinted.
- The date will not be imprinted.

6 Press the OK button.

Prints can be made according to the settings.



- Settings for all images will cancel settings for single images.
- The number of copies applies to all images when you specify the number of copies for all images. Before printing, always check that the number is correct.
- To cancel DPOF settings, set the number of copies to 00 with "All Images" selected.

6 Settings

Setting Menu List	112
How to Operate the Settings Menu	113
Camera Settings	114
Custom Function Chart	127
List of City Names	130

Setting Menu List

Press the Menu button to display the settings menu on the LCD screen. Use the settings menu to set the basic functions of your camera.

Item	Description	Default Setting	Pages
Format	Formats a CF card	Cancel	114
Custom Function	Sets camera functions and settings to suit your purpose.	1	115
Saturation	Set the image saturation level.	<input type="checkbox"/> (Normal)	117
Sharpness	Set the image sharpness.	<input type="checkbox"/> (Normal)	117
Contrast	Set the image contrast level.	<input type="checkbox"/> (Normal)	118
Instant Review	Sets the Instant Review display time.	1 sec	118
Auto Power Off	Sets the time to turn off.	1 min	119
Beep	Sets beep settings.	<input checked="" type="checkbox"/> (On)	119
Date Adjust	Sets the date and time.	01/01/2003	120
World Time	Sets the world time.	<input checked="" type="checkbox"/> (On)	120
Language / 言語	Switches the language for displaying menus and messages on the LCD monitor.	English	122
Video Out	Sets the video output format.	NTSC	123
Brightness Level	Sets brightness of LCD monitor.	0	123
File #	Changes the file No. setting method.	Serial #	124
Slideshow	Plays recorded images successively.	3 sec	125
Sensor Cleaning	Locks the mirror in the up position for cleaning CCD.	Cancel	125
Reset	Returns to defaults settings.	Cancel	126

How to Display the Menu Screen

Turn the camera on and press the MENU button to display the menus on the LCD monitor.

The previously used menu screen is displayed.

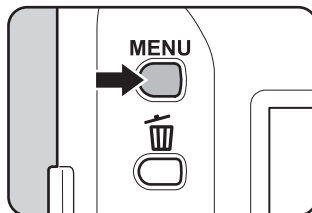

Selecting menu items

Use the four-way controller (▲ ▼) to select the item and then use the four-way controller (◀ ▶) to change the settings. Press the four-way controller (▶) to move to the sub-menu screen when there is a sub-menu screen.

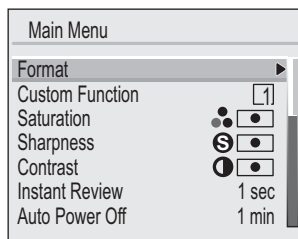

You can also select menu items using the Tv dial and change settings using the Av dial.

Applying menu items

Press the OK button when your menu screen settings are complete. This saves the settings and returns to Capture or Playback mode. Press the OK button to return to the menu when sub-menu settings were made. Press OK again to save the settings and return to Capture or Playback mode.



Even after you press the OK button and close the menu screen, your settings will not be saved if the camera is turned off improperly (such as removing the batteries while the camera is on).

Formatting a CF card

Formatting will delete all the data on the CF card.



- Do not open the CF card cover while formatting a CF card. The card may be damaged beyond use.
- Please note that formatting will delete protected images as well.

1 Select **[Format]** on the Main menu.

2 Press the four-way controller (▶) to display the **[Format]** screen.

3 Select **[Format]** with the four-way controller (▲).

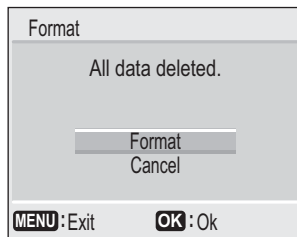

4 Press the **OK** button.

Formatting begins.

The camera is ready to take a picture when formatting is complete.

Setting the Custom Functions

You can set camera functions and settings to match your preferences. Three different settings can be saved separately. See page 127 for detailed settings.

- 1 Select [Custom Function] on the Main menu.
- 2 Press the four-way controller (▶) to display the Custom Function screen.

- 3 Press the four-way controller (◀▶) to select the number from 1 to 3 for the custom function setting to save.

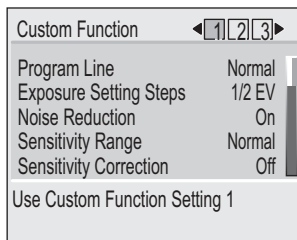

- 4 Use the four-way controller (▲▼) to select the item to set and then use the four-way controller (◀▶) to change the settings.

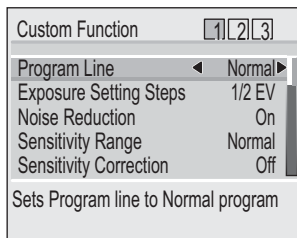

- 5 Press the OK button twice.

This saves the settings and returns to Capture or Playback mode.

Calling up saved functions

- 1 Select [Custom Function] on the Main menu.
- 2 Press the four-way controller (▶) to display the Custom Functions screen.
- 3 Press the four-way controller (◀▶) to select the number for the custom function setting to call up.

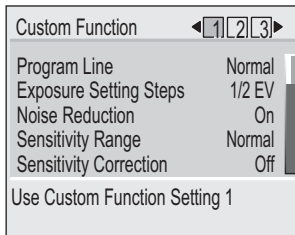



- 4 Press the OK button twice.

This calls up the settings stored under the selected custom function number, and the camera returns to Capture or Playback mode.

Setting the Color Saturation

This sets the brightness of colors in the picture.

1 Select [Saturation] on the Main menu.

2 Press the four-way controller (◀▶) to select from  (Normal),  (High), or  (Low).

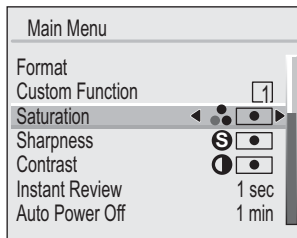



3 Press the OK button.

The camera is ready for capture or playback.

Setting the Image Sharpness

You can make the image outlines sharp or soft.

1 Select [Sharpness] on the Main menu.

2 Press the four-way controller (◀▶) to select from  (Normal),  (Hard), or  (Soft).

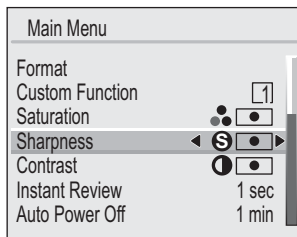



3 Press the OK button.

The camera is ready for capture or playback.

Setting the Contrast

You can set the image contrast level.

1 Select [Contrast] on the Main menu.

2 Press the four-way controller (◀▶) to select from  (Normal),  (High), or  (Low).

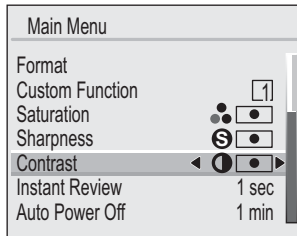

3 Press the OK button.

The camera is ready for capture or playback.

Setting the Instant Review

You can select the Instant Review display time from 1 sec, 3 sec, 5 sec, or OFF.

1 Select [Instant Review] on the Main menu.

2 Press the four-way controller (◀▶) to change the display time.

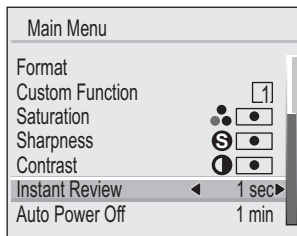

3 Press the OK button.

The camera is ready for capture or playback.

Auto Power Off

You can set the camera to turn off automatically after a certain length of unused.

1 Select [Auto Power Off] on the Main menu.

2 Press the four-way controller (◀▶) to change the time for turning the camera off.

Select from 30 sec, 1 min, 3 min, 5 min, 10 min, 15 min, 30 min, or OFF.

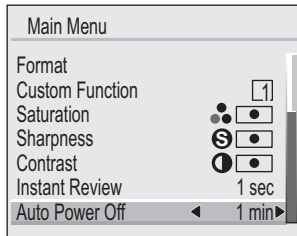

3 Press the OK button.

The camera is ready for capture or playback.



Auto Power Off will not work during playback slideshow, a USB connection and using the AC Adapter.

Turning the Beep On and Off

You can turn the camera operation beep on or off.

1 Select [Beep] on the Main menu.

2 Press the four-way controller (◀▶) to switch between (on) and (off).

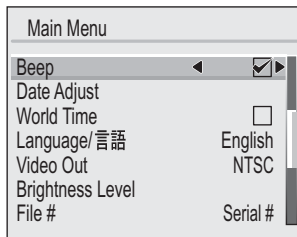

3 Press the OK button.

The camera is ready for capture or playback.

Changing the Date Style and Date / Time

You can change the initial date and time settings. You can also set the date display style. Choose from y/m/d, m/d/y, and d/m/y.

- 1 Select [Date Adjust] on the Main menu.
- 2 Press the four-way controller (▶) to display the [Date and Time] settings screen.

See page 29 for setting the date and time.

Setting the World Time

The date and time set in Initial Setting (p.27) is the Home Time (your usual time zone) settings. Setting the World Time enables you to display the local date and time on the monitor when traveling overseas.

- 1 Select [World Time] on the Main menu.
- 2 Press the four-way controller (▶) to display the [World Time] settings screen.
- 3 Press the four-way controller (◀▶) to switch between (on) and (off).

Displays the time in the country selected in the World time.

Displays the time in the country selected in the Home time.

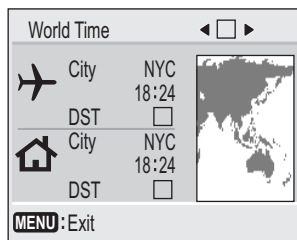

- 4 Press the four-way controller (▼).

To set world time →:

If New York is selected as the world time city, then the cross-shapes line is located in New York on the world map, and then → indicates the current time in New York (NYC).

-
- 5** Press the four-way controller (◀▶) to select the [City], and press the four-way controller (▼).



See The list on p.130 for available cities and their codes.

-
- 6** Press the four-way controller (◀▶) to select DST (on) or (off), and press the four-way controller (▼).

To set home time 🏠:

Press the four-way controller (◀▶) to select the Home time city, or turn DST on and off.

-
- 7** Press the OK button twice.

The camera is ready to capture or play back images with the correct date and time.

Setting the Display Language

You can change the language of the menus and error messages.

1 Select **[Language / 言語]** on the Main menu.

2 Press the four-way controller (▶) to display the **[Language / 言語]** settings screen.

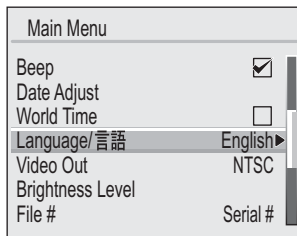

3 Press the four-way controller (▲▼) to select your applicable language.

You can choose the language from the following: English, French, German, Spanish, Italian and Japanese.



4 Press the OK button.

Menus are displayed in the language of your choice.

5 Press the OK button.

The camera is ready for capture or playback.

Selecting the Video Output Format

You can select the output format (NTSC or PAL) for playing back images on a TV monitor.

1 Select [Video Out] on the Main menu.

2 Press the four-way controller (◀▶) to select [NTSC] or [PAL], to match your TV output format.

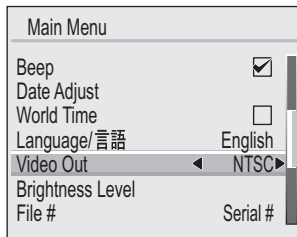

3 Press the OK button.

The camera is ready for capture or playback.

Setting the LCD Monitor Brightness

Change the brightness settings on your LCD monitor.

1 Select [Brightness Level] on the Main menu.

2 Press the four-way controller (▶) to display the [Brightness level] settings screen.

3 Press the four-way controller (◀▶) to adjust the brightness while watching the LCD monitor.

Press the four-way controller (◀) to darken the display, and the four-way controller (▶) to brighten it.

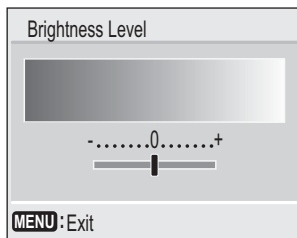

4 Press the OK button twice.

The camera is ready for capture or playback.

Resetting the File Number

You can set the File Number used for the images when inserting a new CF card.

1 Select [File #] on the Main menu.

2 Press the four-way controller (◀▶) to switch between [Reset] and [Serial #].

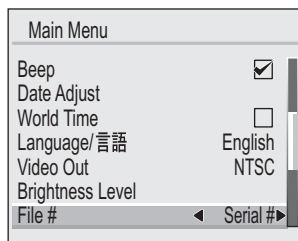

Reset: The File Number used for the images reverts to the smallest number when inserting each new CF card. When a recorded CF card is inserted, the consecutive No. is set.

Serial #: The File Number for the most recently captured image is placed in memory, and the File No. will remain consecutive after inserting a new CF card.

3 Press the OK button.

The File Number will be assigned to each image, according to the settings.

Setting the Slideshow

You can play back all recorded images on your CF card successively. To start continuous playback, use the menu screen displayed on the LCD monitor.

- 1 Press the **Playback** button and use the four-way controller (◀▶) to select the image to start the slideshow.
- 2 Select **[Slideshow]** on the Main Menu and press the four-way controller (▶) to display the **[Slideshow]** settings screen.
- 3 Press the four-way controller (◀▶) to change the playback interval.

Select from 3 sec, 5 sec, 10sec, 15 sec, 20 sec and 30 sec.

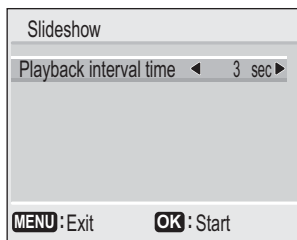

- 4 Press the **OK** button.

Playback will start at the specified interval.



- Pressing the shutter release button, four-way controller or the MENU button during continuous playback will stop the slideshow.
- Slideshow stops when after one loop.

Sensor Cleaning

Lock the mirror in the up position for cleaning the CCD.
See page 149 for cleaning the CCD.

- 1 Select **[Sensor Cleaning]** on the Main menu.
- 2 Press the four-way controller (▶) to display the **[Sensor Cleaning]** screen.

- 3 Press the four-way controller (▲) to select [Mirror Up].

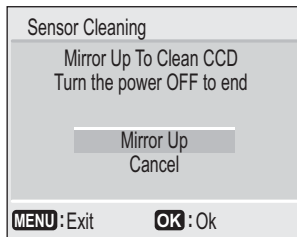

- 4 Press the OK button.

The mirror is locked in the up position.
After cleaning the CCD, turn the camera off.

Resetting to Default Settings

This resets all settings other than Date / Time, Language / 言語, Video Out, Date Style and World Time.

6

Settings

- 1 Select [Reset] on the Main menu.
- 2 Press the four-way controller (▶) to display the [Reset] screen.
- 3 Press the four-way controller (▲) to select [Reset].

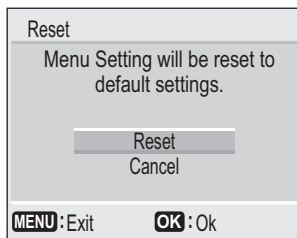

- 4 Press the OK button.

The camera is ready for capture or playback.

This chart shows the custom functions that can be set.

Item	Setting items	Explanation
Program Line	Normal (Default Setting) Hi-Speed Depth MTF	Sets Program line to Normal program. Sets Program line to High-speed priority program. Sets Program line to Depth-of-field priority program. Sets Program line to MTF priority program.
Exposure Setting Steps	1/2EV (Default Setting) 1/3EV	Exposure setting steps are set to 1/2EV. Exposure setting steps are set to 1/3EV.
Noise Reduction	On (Default Setting) Off	Noise Reduction will activate in slow speed shooting. Noise Reduction not activated.
Sensitivity Range	Normal (Default setting) Wide	Sensitivity can be set from 200-1600. Sensitivity can be set from 200-3200.
Sensitivity Correction	Off (Default Setting) On	No automatic sensitivity correction. Automatic sensitivity correction when exposure is out of range.
Recorded pixels of S	1536×1024 (Default Setting) 1152×768 960×640	Records S size at 1536×1024. Records S size at 1152×768. Records S size at 960×640.
Hyper Program	On (Default Setting) Off	Uses Hyper program function. No Hyper program function.
Green Button in Manual	P (Default Setting) Tv Av	Return to proper exposure on the program line with Green Button. Shift only Tv for proper exposure with Green button. Shift only Av for proper exposure with Green button.
Link AF Point and AE	Off (Default Setting) On	No adjustment of AE in multi-segment metering based on AF point. Automatically adjusts AE in multi-segment metering based on AF point.
AF with Press Halfway	On (Default Setting) Off	AF operates when shutter release button is pressed halfway. AF will not operate when shutter release button is pressed halfway.
Auto Bracketing Order	0+ (Default Setting) -0+ +0-	Sets the Auto bracketing shoot order to correct / minus / plus. Sets the Auto bracketing shoot order to minus / correct / plus. Sets the Auto bracketing shoot order to plus / correct / minus.
Shutter Release w / o CF	On (Default Setting) Off	Enables shutter release when no CF card is inserted. Disables shutter release when no CF card is inserted.

Item	Setting items	Explanation
F stop other than A	Off (Default Setting) On	Disables shutter release when lens aperture is set at other than A. Enables shutter release even when lens aperture is set at other than A.
Release when Charging	Off (Default Setting) On	Disables shutter release while the built-in flash is charging. Enables shutter release while the built-in flash is charging.
Flash in Wireless Mode	On (Default Setting) Off	Fires built-in flash as master in Wireless Mode. Fires built-in flash as controller in Wireless Mode.
Flash with OK Button	Off (Default Setting)	Disable external flash firing with OK button.
	Test	Test fires external flash with OK button.
	Modeling	Fires modeling flash of external flash with OK button.
Meter Operating Time	3sec	Sets exposure metering timer to 3 seconds.
	5sec	Sets exposure metering timer to 5 seconds.
	10sec (Default Setting)	Sets exposure metering timer to 10 seconds.
	15sec	Sets exposure metering timer to 15 seconds.
	30sec	Sets exposure metering timer to 30 seconds.
Self-timer Delay Time	12sec (Default Setting)	Sets self-timer delay time to 12 seconds.
	2sec	Sets self-timer delay time to 2 seconds.
Remote Control Delay	3sec (Default Setting)	Shutter will be released 3seconds after remote control is pressed.
	0sec	Shutter will be released immediately when remote control is pressed.
Superimpose AF Area	On (Default Setting)	Superimposed AF area is displayed
	Off	Superimposed AF area is not displayed
Use LCD w / Video Output	Off (Default Setting)	LCD monitor is turned OFF during video output.
	On	LCD monitor turned ON during video output.
Color Space	sRGB (Default Setting)	Sets to sRGB color space.
	Adobe RGB	Sets to AdobeRGB color space.
Reset Custom Function	Reset / Cancel	Resets Custom Function X to default settings.

Notes on setting “F stop other than A”

When the “F stop other than A” in the custom functions is set to “On”, the shutter can be released even if the aperture ring of an attached lens is not set to the **A** position. However, the features will be restricted as shown in the table below.

Lenses	Exposure mode	Restriction
FA, F, A, M, S (lens only, or with auto diaphragm accessories such as auto extension tube K)	Aperture-Priority AE mode	The aperture remains wide open regardless of the aperture ring position. The shutter speed varies according to the aperture ring position, however, an exposure error may occur. Aperture value displays [F--] in the viewfinder and [AV--] on the LCD panel.
FA, F, A, M, S (with manual diaphragm accessories such as extension tube K)	Aperture-Priority AE mode	Pictures can be taken with the specified aperture value, however, an exposure error may occur.
Manual diaphragm lens, such as reflex lens (lens only)	Aperture-Priority AE mode	Aperture value displays [F--] in the viewfinder and [AV--] on the LCD panel.
FA, F Soft 85mm FA Soft 28mm (lens only)	Aperture-Priority AE mode	Pictures can be taken with the specified aperture value and shutter speed, however, the built-in light meter does not operate, therefore, the exposure cannot be evaluated. Aperture value displays [F--] in the viewfinder and [AV--] on the LCD panel.
All lenses	Metered Manual	Pictures can be taken with the aperture value manually specified, however, an exposure error may occur. Aperture value displays [F--] in the viewfinder and [AV--] on the LCD panel.

List of City Names

Refer to following list of city and code names for setting the world time.

Region	City	Code	Region	City	Code
EUROPE	Madrid	MAD	ASIA	Shanghai	SHA
	London	LON		Manila	MNL
	Paris	PAR		Taipei	TPE
	Milano	MIL		Seoul	SEL
	Rome	ROM		Tokyo	TYO
	Berlin	BER		OCEANIA	Pagopago
	Moscow	MOW	Perth		PER
AFRICA	Johannesburg	JNB	Adelaide		ADL
	Cairo	CAI	Sydney		SYD
MIDDLE EAST	Istanbul	IST	Noumea		NOU
	Jerusalem	JRS	Wellington	WLG	
	Jeddah	JED	Auckland	AKL	
	Tehran	THR	NORTH AMERICA	Guam	GUM
	Dubai	DXB		Honolulu	HNL
Kabul	KBL	Anchorage		ANC	
ASIA	Karachi	KHI		San Francisco	SFO
	Male	MLE		Los Angeles	LAX
	Delhi	DEL		Denver	DEN
	Colombo	CMB		Chicago	CHI
	Kathmandu	KTM		Miami	MIA
	Dacca	DAC		New York	NYC
	Rangoon	RGN		Vancouver	YVR
	Bangkok	BKK	Calgary	YYC	
	Kuala Lumpur	KUL	Toronto	YTO	
	Vientiane	VTE	Halifax	YHZ	
	Singapore	SIN	CENTRAL & SOUTH AMERICA	Mexico City	MEX
	Phnom Penh	PNH		Santiago	SCL
	Ho chi Minh	SGN		Caracas	CCS
	Jakarta	JKT		Buenos Aires	BUE
	Hong Kong	HKG		Sao Paulo	SAO
	Beijing	BJS		Rio de Janeiro	RIO

7 Connecting

Connecting to a TV.....	132
Connecting to a PC	133

Connecting to a TV

By using the video cable (I-VC2), you can play back images using a TV or other equipment with a video IN jack as your monitor. Make sure that both the TV and the camera are turned off before connecting the cable.

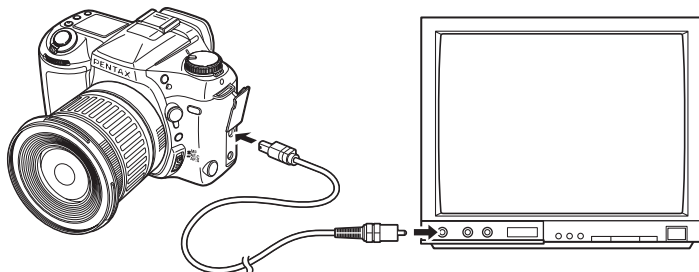

- 1** Connect the video cable to the PC / Video terminal on the camera.
- 2** Connect the other end of the video cable to the video IN jack on the TV.
- 3** Turn on the TV and the camera.



- If you intend to use the camera continuously for a long period, use of the AC adapter D-AC10 (optional) is recommended. Please refer to the operating manual of the TV or other connected equipment.
- You can set a custom function to turn the LCD monitor on while connected to a TV. See page 115 for setting Custom Functions.

With your camera and PC connected with a USB cable (I-USB2), you can transfer images to your PC, and view images or develop RAW data using the PENTAX Photo Browser or PENTAX Photo Laboratory. See manuals for installing PENTAX Photo Browser and PENTAX Photo Laboratory and for viewing images and RAW data development.

The following example shows how to connect your camera to your PC.

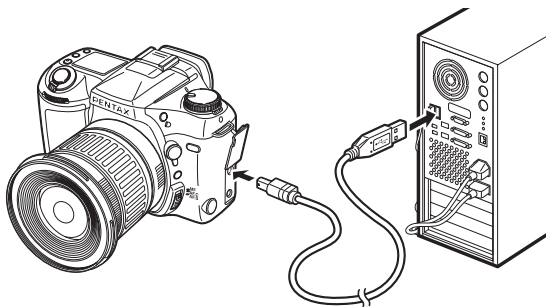

- 1 Turn on your PC.**
- 2 Make sure the camera is turned off and connect the PC / Video terminal on the camera and the USB terminal on your PC with the USB cable.**

Confirm that the CF card is inserted in the camera.

- 3 Turn on the camera.**



- The camera is recognized as a [Removable Disk] in [My Computer].
- USB data transfer time will differ depending on your computer and CF card performance.

8 Appendix

More Details about Capture Functions	136
Optional Accessories.....	146
Cleaning the CCD	149
Precautions Regarding Memory Cards	151
Error Messages	152
Troubleshooting	153
Main Specifications.....	154
Glossary	160
WARRANTY POLICY	162

More Details about Capture Functions

Effect of Aperture and Shutter Speed

Correct exposure of the subject is established by a combination of shutter speed and aperture setting. There are many correct combinations of shutter speed and aperture for a particular subject. Different shutter speed and aperture settings produce different effects.

Effect of shutter speed

The shutter speed determines the length of time that the light is allowed to strike the CCD, to adjust the amount of light striking the CCD.

- **Using slower shutter speed**

If the subject is moving, the image will be blurred because the shutter is open longer. It is possible to enhance the effect of motion (rivers, waterfalls, waves, etc.) by intentionally using a slower shutter speed.

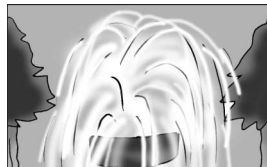

- **Using faster shutter speed**

Choosing a faster shutter speed will allow freezing the action of a moving subject. Even if the subject is not moving, a faster shutter speed also helps prevent camera shake.

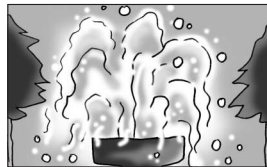

Effect of aperture

The aperture increases or reduces the light beam (thickness) which passes through the lens, controlling how much light strikes the CCD.

• Widening the beam by opening the aperture

Objects closer and farther than the focused subject will be more out of focus. For instance, if you take a picture of a person against a landscape with the aperture open, the landscape in front of and behind the person will be blurred, emphasizing only the person.



• Narrowing the beam by closing the aperture

The range in focus expands forward and back. For instance, if you take a picture of a person against a landscape with the aperture narrowed, the landscape in front of and behind the person will be in focus.



- When you focus on a portion of the subject, there is a range in which object closer and farther will also be in focus. This focused range is called the depth of field.
- As the aperture is stopped down, the depth of field (focused range) increases (wider range of focus).
- Also, the wide-angle lens, and the farther away the subject, the wider the depth of field.
- Zoom lenses do not have a scale for depth of field because of their structure.
- The depth of field for the **istD* differs depending on the lens but, compared to when using a 35mm camera, the value is roughly one aperture setting lower (the focused range becomes narrower).
Further, check the depth of field at one stop open side for lenses with a depth of field scale.

How to check depth of field

When you focus on a portion of the subject, there is a range in which object closer and farther will also be in focus. This focused range is called the depth of field. If you use Preview, you can check the depth of field in the viewfinder before taking a picture.

1 Focus on the subject.

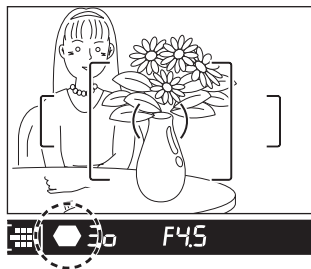

2 Turn the main switch to while looking through the viewfinder.

You can check the depth of field in the viewfinder while holding down the main switch.

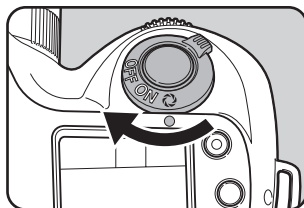

- No shooting information is displayed in the viewfinder, and the shutter cannot be released while the main switch is in the  position.
- You can check the depth of field in all exposure modes.
- The focus range in the viewfinder may differ slightly from the actual picture.

Calculating flash distance from the aperture used (using built-in flash)

Maximum flash distance = Guide Number \div Selected aperture
 Minimum flash distance = Maximum flash distance \div 5* (Note)

The flash cannot be used when the distance is less than 0.7m. When the flash is used within 0.7m, it causes vignetting in the picture corners, light is distributed unevenly and the picture may be over-exposed.

* The value 5 used in the formula above is a fixed value which applies to using the built-in flash alone.

The guide number depends upon the sensitivity (ISO) used as shown below.

ISO200 \rightarrow 15.6	ISO800 \rightarrow 31	ISO3200 \rightarrow 62
ISO400 \rightarrow 22	ISO1600 \rightarrow 44	

This example uses ISO200 with an aperture of f/4.

Guide number (15.6) \div f/4 = 3.9m

3.9 \div 5 \approx 0.8m

Therefore, the flash can be used in a range of about 0.8m to 3.9m.

Calculating aperture used from the flash distance (using the built-in flash)

Guide number \div camera-to-subject distance = Aperture

If the resulting number (3) is not available as a lens aperture, the smaller number (2.8) is generally used.

F, FA and FA J Lenses Compatibility with the Built-in Flash

○ = compatible, × = incompatible because of vignetting

Both are evaluated without a hood.

Lens Name	Compatible
F Fisheye Zoom 17~28mm f/3.5~4.5	△ Vignetting may occur if focal length is less than 20mm.
FA J zoom 18~35mm f4~5.6 AL	△ Vignetting may occur if focal length is 18mm and the object distance less that 1m.
FA Zoom 20~35mm f/4AL	○
FA Zoom 24~90mm f/3.5~4.5AL (IF)	○
FA Zoom 28~70mm f/4AL	○
FA* Zoom 28~70mm f/2.8AL	△ Vignetting may occur if focal length is between 28-35mm and the object distance less that 1m.
FA J Zoom 28~80mm f/3.5~5.6	○
FA Zoom 28~80mm f/3.5~5.6	○
FA Zoom 28~90mm f/3.5~5.6	○
FA Zoom 28~105mm f/4~5.6	○
FA Zoom 28~105mm f/4~5.6 (IF)	○
FA Zoom 28~105mm f/3.2~4.5AL (IF)	○
FA Zoom 28~200mm f/3.8~5.6AL (IF)	○
FA Zoom 35~80mm f/4~5.6	○
FA Zoom 70~200mm f/4~5.6	○
FA J Zoom 75~300mm f/4.5~5.8AL	○
FA* Zoom 80~200mm f/2.8ED (IF)	○
FA Zoom 80~320mm f/4.5~5.6	○
FA Zoom 80~200mm f/4.7~5.6	○
FA Zoom 100~300mm f/4.7~5.8	○
FA* Zoom 250~600mm f/5.6ED (IF)	×

Lens Name	Compatible
FA20mm f/2.8	○
FA* 24mm f/2AL (IF)	○
FA28mm f/2.8AL	○
FA31mm f/1.8AL Limited	○
FA35mm f/2AL	○
FA43mm f/1.9 Limited	○
FA50mm f/1.4	○
FA50mm f/1.7	○
FA77mm f/1.8 Limited	○
FA*85mm f/1.4 (IF)	○
FA135mm f/2.8 (IF)	○
FA*200mm f/2.8ED (IF)	○
FA*300mm f/2.8ED (IF)	×
FA*300mm f/4.5ED (IF)	×
FA*400mm f/5.6ED (IF)	○
FA*600mm f/4ED (IF)	×
FA Macro 50mm f/2.8	○
FA Macro 100mm f/2.8	○
FA Macro 100mm f/3.5	○
FA* Macro 200mm f/4ED (IF)	○
FA Soft 28mm f/2.8	○
FA Soft 85mm f/2.8	○

Setting the White Balance Manually

You can set the white balance with the camera pointed toward a white object under the lighting to be used for taking pictures. The camera can store delicate shades that cannot be precisely adjusted with the white balance provided in the camera (p.55). This provides the optimum white balance for your surroundings. White balance set manually can be placed in the camera memory in three ways.

- 1 Set the mode dial to **WB** and turn the **Av** dial to select [WB].

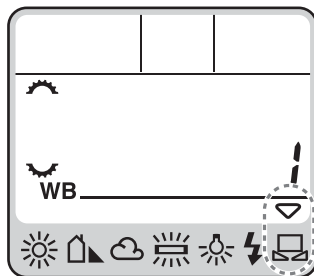

- 2 Turn the **Tv** dial to set the registration number for placing manual white balance in memory. (1~3)

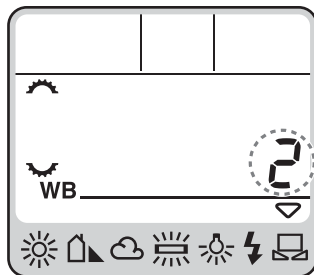

- 3 Set the mode dial to the capture mode to be used and fill the viewfinder completely with white or gray paper, etc., under the desired lighting for setting the white balance.

4 Hold down the manual white balance button and press the shutter release button.

Set correctly:

[OK] appears on the LCD monitor.

Incorrectly set:

[NG] appears on the LCD monitor.

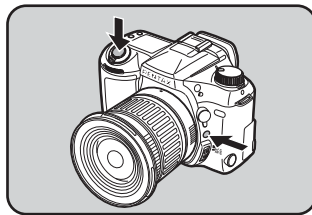

- No image is recorded when the shutter release button is pressed to register the white balance.
- The registered white balance is only enabled when white balance is set to [☐].

Color temperature

The color of light shifts to a bluish color as the color temperature rises, and to a reddish color as the color temperature falls. Color temperature describes this change in light color in terms of absolute temperature (K: Kelvin). This camera is capable of setting the white balance to enable taking pictures with natural coloring under a variety of lighting conditions.

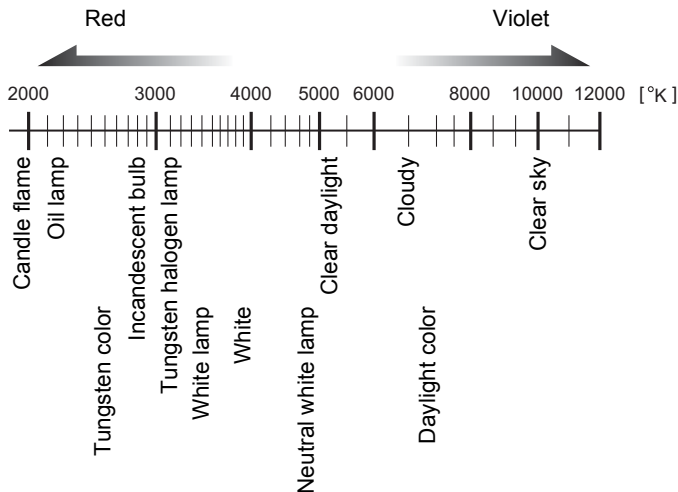

FUNCTIONS AVAILABLE WITH VARIOUS LENS COMBINATIONS

Lenses that can be used with this camera

Only FA J lenses and FA/F/A lenses having an A position on the aperture ring can be used with this camera. Other lenses and FA/F/A lenses with aperture ring set to other than A position cannot be used because the shutter will not release.

Function	Lens [Mount type]	FA J, FA lens [KAF, KAF2]*3	F lens [KAF, KAF2]*3	A lens [KA]
Autofocus (Lens only) (With AF adapter 1.7X)*1		○ -	○ -	× ○
Manual focus • (With the focus indicator)*2 • (With Matte field)		○ ○	○ ○	○ ○
Eleven focus points		○	○	×
Power zoom		×	×	×
Aperture-priority AE		○	○	○
Shutter speed-priority AE		○	○	○
Metered Manual		○	○	○
P-TTL Auto Flash*4		○	○	×
TTL Auto Flash		○	○	○
Multi (16)-segment metering		○	○	○

- : Functions can be used freely when the aperture ring is set to the A position.
 ×: Functions cannot be used.

- *1: Lenses with a maximum aperture of f/2.8 or larger. Only usable at A position.
 *2: Lenses with a maximum aperture of f/5.6 or larger.
 *3: To use an F/FA soft 85mm f/2.8 lens or FA soft 28mm f/2.8 lens, set custom function to allow shutter release with a lens aperture other than A. Pictures can be taken with the aperture you set, but only within manual aperture range.
 *4: When using the built-in flash and AF360FGZ.

Lens names and mount names

FA single focal length lenses (non-zoom lenses) and FA J and F lenses use the KAF mount. Of the FA zoom lenses, power zoom enabled lenses use the KAF2 mount. Lenses without power zoom use the KAF mount. See the lens manual for details. This camera does not have a power zoom mechanism.

Lenses and accessories that cannot be used with this camera

Only FA J lenses or lenses that have the A (Auto) position on the aperture ring can be used.

The camera does not operate under the following conditions unless a custom function is set to enable shutter release even when lens aperture is set at other than A:

- When a lens without an A position is used.
- When an F or FA lens is used and the aperture ring is set to a position other than the A position.
- When accessories such as an auto extension tube or auto bellows are used.

See page 115 for setting custom functions.

And see Notes on setting “F stop other than A” on page 129 when using the lens other than the **A** (Auto) position since there are some restrictions.

A number of dedicated accessories are available for this camera. Please contact our service center for details regarding accessories.

Battery grip D-BG1

Usability is enhanced with the shutter release and AE lock buttons and Tv, Av dials for vertical positioning of the camera.

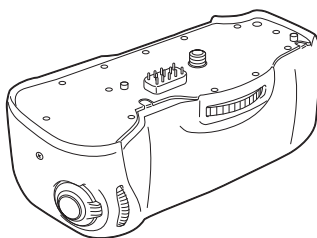

Capacity remaining

Batteries (Actual temperature)		Normal recording	Flash photography		Playback time
			50% use	100% use	
CR-V3	(20°C)	Approx.800	Approx. 750	Approx.650	Approx.450 min.
	(0°C)	Approx.550	Approx. 500	Approx.450	Approx.350 min.
AA Lithium	(20°C)	Approx.750	Approx.650	Approx.600	Approx.350 min.
	(0°C)	Approx.650	Approx.600	Approx.500	Approx.300 min.
Ni-MH	(20°C)	Approx.400	Approx.350	Approx.300	Approx.250 min.
	(0°C)	Approx.350	Approx.300	Approx.250	Approx.200 min.
AA-Alkaline	(20°C)	Approx.100	Approx.90	Approx.70	Approx.100 min.
	(0°C)	Not applicable	Not applicable	Not applicable	Approx.40 min.

AC adaptor D-AC10

This AC adaptor supplies power from the outlet into your camera.

Cable Switch

Cable switch CS-205

This is a remote shutter release cord. The cord length is 0.5m.

Flash Accessories

Auto Flash AF360FGZ

An auto flash unit with maximum guide number 36 (ISO 100/m). Its features include AF spot beam, slave-sync flash, multiple-flash, high-speed sync, wireless flash, contrast-control-sync flash, and leading / trailing curtain-sync modes.

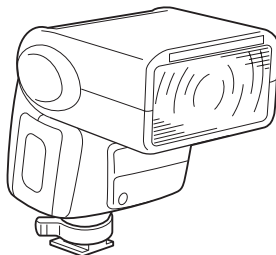

Auto flash AF500FTZ

A Zoom flash with a built-in AF spot beam and maximum guide number 50 (ISO 100/m). It features the slave-sync flash function, multiple-flash, contrast-control-sync flash, and leading / trailing-curtain-sync flash mode.

Macro Flash AF140C

A macro flash unit with a guide number of 14 (ISO 100/m).

Off-Camera shoe Clip CL-10

A setting clip for using the AF360FGZ as a wireless slave flash.

Hot Shoe Adapter F_G, Extension Cord F5P and Off-Camera shoe Adapter F

The adapters and cords to use the external flash away from the camera.

For Viewfinder

Magnifier FB

A viewfinder accessory for magnifying the central area of the viewfinder.

Ref-converter A

An accessory that changes the viewfinder viewing angle at 90 intervals. The viewfinder magnification can be switched between 1× and 2×.

Diopter correction lens adapter M

This accessory adjusts the diopter. Install it on the viewfinder. If it is difficult to see the viewfinder image clearly, choose one of the eight correction lenses M of -5, -4, -3, -2, -1, +1, +2 and +3 m(-1).

Camera Case

Soft Case O-CC10



Others

Eyecup FL



Camera strap O-ST10

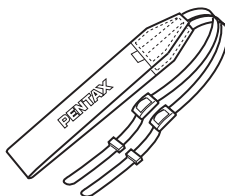

If the CCD becomes dirty or dusty, white flecks may appear in the background or a shadow in the image under some conditions. This indicates that the CCD must be cleaned. The CCD is a precision part. Please contact PENTAX service center.

- 1 Turn the camera on and remove the lens.**
- 2 Set [Sensor Cleaning] on the Main menu to ON.**
- 3 Use the four-way controller (▲▼) to select [Mirror up] on the [Sensor Cleaning] screen.**

- 4 Press the OK button.**

The mirror is locked in the up position.

- 5 Clean the CCD.**

Use a brush-less blower to remove dirt and dust from the CCD. If a blower with a brush is used, the brush may scratch the CCD. Never wipe the CCD with a cloth.

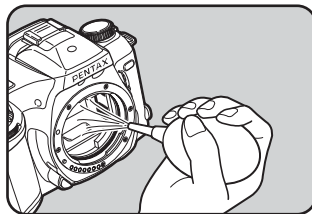

- 6 Turn the camera off and attach the lens after the mirror returns to its original position.**



- Do not use a spray type blower.
- Do not clean the CCD when the exposure mode is set to **B** (Bulb) mode.
- Always cap the lens mount area to prevent dirt and dust from accumulating on the CCD when no lens is on the camera.
- It is recommended that you use the AC adaptor when cleaning the CCD.
- When the battery level is low, "Not enough battery remaining to clean sensor" is displayed on the LCD monitor.
- If you are not using the AC adapter, please use batteries with ample capacity remaining. A warning beep will sound if the battery capacity becomes low during cleaning. Please interrupt your cleaning operation immediately.
- Do not put the tip of the blower inside the lens mount area. If the power is turned off, this could cause damage to the shutter or the CCD sensor.

Precautions When Using a CF Card

- Make sure the camera is turned off before opening the CF card cover.
- Care should be taken if you remove the CF card immediately after using the camera as the card may be hot.
- Do not remove the CF card or turn the camera off while data is being recorded on the card or transferred to PC using USB cable as this may cause the data to be lost or the card to be damaged.
- Do not bend the CF card or subject it to violent impact. Keep it away from water and store away from high temperature.
- Be sure to format unused CF card or CF card that have been used on another camera. Refer to “Formatting a CF card” p.114 for instructions on formatting.
- Never remove the CF card during formatting as this may cause the card to be damaged and become unusable.
- Time required for recording to the CF card will differ depending on picture conditions and card performance.
- The data on the CF card may be erased in the following circumstances. Pentax does not accept any liability for data that is erased.
 - When the CF card is mishandled by the user.
 - When the CF card is exposed to static electricity or electrical interference.
 - When the card has not been used for a long time
 - When the card is ejected, the AC adapter is disconnected or the battery is removed while the data on the card is being accessed.
- The CF card has a limited service life. If it is not used for a long time, the data on the card may become unreadable. Be sure to make a backup of important data on a PC.
- Avoid using or storing the card where it may be exposed to static electricity or electrical interference.
- Avoid using or storing the card in direct sunlight or where it may be exposed to rapid changes in temperature or to condensation.



Precautions When Using a Microdrive™

- The Microdrive™ is a small, light-weight hard disk drives. Because it is rotating recording media, it does not handle vibration or impact well. When using a Microdrive™, be very careful not to subject the camera to vibration or impact.
- A Microdrive™ may get hot when used for long periods. Please handle carefully.
- Do not place a Microdrive™ near a strong magnetic field.
- Time required for recording to the Microdrive™ will differ depending on picture conditions and Microdrive™ performance.

Error Messages

Error Messages	Description
Memory full	The CF card memory is full, and no more images can be saved. Insert a new CF card or delete unwanted images. (p.34, 102) You may be able to save the image by changing the quality level or recorded pixels. (p.51, 52)
No image.	There are no images for playback on the CF card.
Camera cannot display this image	You are trying to play back an image not supported by this camera. You may be able to display this on a PC or another brand of camera.
No card in camera	The CF card is not inserted in the camera. (p.34)
Battery depleted	The battery is exhausted. Install new batteries in the camera. (p.23)
Memory card error	The CF card has a problem, and image capture and playback are impossible. Try displaying it on a PC.
Card not formatted	The CF card inserted is not formatted, or has been formatted on a PC or other device. (p.34)
Cannot use card	The inserted card cannot be used. Insert a usable card.
Image folder could not be created	The maximum folder and file number has been used, and no more images can be saved. Insert a new CF card or format the CF card. (p.114)
Settings not stored	The CF card memory is full, and no more DPOF settings can be made.
Could not save image	The image could not be saved because of a CF card error.
Not enough battery remaining to clean sensor	The battery is almost gone. Replace the battery with a new one or use an optional AC adaptor.
Battery level is low. End cleaning.	Battery became nearly depleted during Mirror Up. End the CCD cleaning process. (p.149)

We recommend to check the following items before contacting a service center.

Symptoms	Causes	Remedies
The shutter does not release. Nothing is displayed on the LCD panel.	The lens aperture ring setting is other than the A position.	Set the lens aperture ring to the A position. (p.60)
	The main switch is OFF.	Turn the main switch ON. (p.26)
	The low battery warning  is blinking.	Replace the battery. (p.21)
	The batteries are installed upside-down.	Install the batteries properly. (p.21)
	The mode dial is in the  or WBISO position.	Set the mode dial to one of the capture modes.
The Autofocus does not work.	The subject is not within the AF frame.	Move the camera until subject is inside of the AF frame. (p.17)
	The subject is too close.	Increase the camera-to-subject distance.
	The focus mode is set to MF or AFC .	Set the focus mode lever to AFS . (p.70)
	Hard-to-Autofocus subjects	Focus manually by using the matte field. (p.74)
AE lock function does not operate.	AE lock is not available when set to green operation mode, M (Metered manual exposure) mode or B (bulb) mode.	Set to one of the capture modes other than the green program AE mode or M (Metered manual exposure) mode.
The built-in flash does not discharge even if the flash is in the popped-up position.	When A appears on the LCD panel, the built-in flash does not discharge in bright lighting conditions.	(p.86)
The power zoom system does not function.	The camera does not have the power zoom function.	Use manual zoom. (p.81)

In rare cases, the camera may not operate correctly due to static electricity. This can be remedied by taking the batteries out and putting them back in again. When the mirror remains in the up position, take the batteries out and put them back in again. Then, turn the power on, and turn the power off with pressing the shutter release button. The mirror will retract. After the procedure is done, if the camera operates correctly, it does not require any repairs.























Main Specifications



Type	TTL autofocus, auto-exposure SLR digital-still camera with built-in retractable P-TTL flash
Effective Pixels	6.10 megapixels
Sensor	Total pixels 6.31 megapixels (3110 × 2030), interline / interlace scan CCD with a primary color filter
Recorded Pixels	L (3008 × 2008 pixels), M (2400 × 1600 pixels), S (1536 × 1024, 1152 × 768, 960 × 640 pixels)
Sensitivity	Equivalent to ISO200, ISO400, ISO800, ISO1600, and ISO3200
File Format	RAW, TIFF (non-compressed), JPEG (Exif2.2), DCF compliant, DPOF compatible
Quality Level	RAW, TIFF, Best, Better, and Good
Storage Medium	CompactFlash™ (CF) Type I / Type II and Microdrive™

Number of Shots

Capacity	Size	TIFF		
	RAW	3008 × 2008(L)	2400 × 1600(M)	1536 × 1024(S)
1GB	Approx.70	Approx.55	Approx.87	Approx.209
Microdrive 1GB	Approx.73	Approx.58	Approx.92	Approx.220
512MB	Approx.34	Approx.27	Approx.43	Approx.104
Microdrive 340MB	Approx.23	Approx.19	Approx.30	Approx.73
256MB	Approx.16	Approx.14	Approx.21	Approx.52
128MB	Approx.7	Approx.6	Approx.10	Approx.26
64MB	Approx.3	Approx.3	Approx.5	Approx.13
32MB	Approx.1	Approx.1	Approx.2	Approx.6

Capacity	3008 × 2008(L)			2400 × 1600(M)			1536 × 1024(S)		
	Best ★★★	Better ★★	Good ★	Best ★★★	Better ★★	Good ★	Best ★★★	Better ★★	Good ★
1GB	Approx.243	Approx.473	Approx.908	Approx.382	Approx.716	Approx.1350	Approx.908	Approx.1636	Approx.2832
Microdrive 1GB	Approx.255	Approx.495	Approx.956	Approx.400	Approx.754	Approx.1420	Approx.956	Approx.1721	Approx.2980
512MB	Approx.119	Approx.232	Approx.452	Approx.185	Approx.354	Approx.676	Approx.452	Approx.812	Approx.1412
Microdrive 340MB	Approx.81	Approx.159	Approx.313	Approx.126	Approx.245	Approx.470	Approx.313	Approx.565	Approx.984
256MB	Approx.57	Approx.111	Approx.222	Approx.87	Approx.172	Approx.335	Approx.222	Approx.401	Approx.701
128MB	Approx.25	Approx.50	Approx.106	Approx.38	Approx.80	Approx.163	Approx.106	Approx.196	Approx.346
64MB	Approx.10	Approx.19	Approx.47	Approx.13	Approx.35	Approx.76	Approx.47	Approx.93	Approx.169
32MB	Approx.4	Approx.6	Approx.19	Approx.5	Approx.12	Approx.34	Approx.19	Approx.42	Approx.81

Exposure mode	Green program AE mode, P (Hyper program) mode, Tv (Shutter-priority) mode, Av (Aperture-priority) mode, M (Hyper manual exposure) mode, and B (Bulb) mode
LCD Monitor	1.8 inch TFT Color LCD monitor with 118,000 pixels (with backlight)
Shutter	Electronically controlled vertical-run focal-plane shutter, Electromagnetic release, Speed range (1) Auto 1/4000-30 sec. (step less), (2) Manual 1/4000-30 sec. (1/2 EV step or 1/3 EV step) (3) Bulb Shutter lock by setting Main switch in OFF position.
Lens Mount	Pentax KAF bayonet mount (K-mount with AF coupler, lens information contacts)
Compatible Lens	Pentax KAF2, KAF mount lenses, KA mount lenses
Autofocus System	TTL phase-matching autofocus system (SAFOX VIII), AF operational brightness range: EV 0 to 19 (at ISO 200 with f/1.4 lens), Focus lock available, Focus Mode: AF.S (single) / AF.C (predictive continuous) / MF (manual), focus points changeable.
Viewfinder	Penta-prism finder, Natural-Bright-Matte focusing screen, Field of view: 95%, Magnification 0.95 × (with 50mm f/1.4 lens at ∞), Diopter: -2.5 to +1.5 m ⁻¹ .
Viewfinder Indication	Focus Information: In-focus (Green lamp  is lit), front or back focus Indication signals and unable-to-focus indicator (Green lamp  blinks), Shutter speed indication, Aperture indication, Flash ready indication  is lit, Bar graph (exposure compensation, Over or Under exposure indication in Metered Manual Mode, exposure compensation indication), Av dial enabled, Tv dial enabled, focus points, and  =(AE lock).
External LCD	 is lit=Built-in flash ready, Blinking=Flash recommended warning or inappropriate lens warning,   =Automatic flash,   =Red-eye reduction automatic flash,   =Wireless mode,   =Wireless high-speed sync mode,  =Flash ON,  =Single-frame drive mode,  =Consecutive shooting,  =Self-timer,  =Remote control shooting,  =Battery exhaustion warning,  =Auto bracketing exposure (exposure setting steps can be set to 1/2Ev or 1/3Ev),  =Multiple exposure,  =Busy display,  =Beep, Shutter speed, Aperture value, Recorded Pixels, Quality Level, Tv dial enabled, Av dial enabled, Sensitivity, White Balance, Capacity remaining, Number of multiple exposure shots, Bracket frames, and Exposure compensation.
Preview	Electronically controlled and usable in all exposure modes

Self-timer	Electronically controlled with delay time of 12 sec. with mirror lock up in used. Start by pressing shutter release button. Operation confirmation: Possible to set PCV beep. Cancellable after operation
Mirror	Quick-return mirror, mirror lock up function (2 sec. self-timer possible)
Auto bracket exposure	Three frames consecutive shots with exposure bracketing in [Selectable between 1/2EV and 1/3EV for Exposure setting step]
Exposure Meter	TTL multi(16)-segment metering, Metering range from EV1 to EV21.5 at ISO200, with 50mm f/1.4 lens, Center-weighted and Spot metering mode can be set.
EV compensation	±3 EV in 0.5 EV steps increments
AE lock	Button type (timer type 20 sec.) possible to continue with shutter button halfway pressed
Built-in flash	GN 15.6 (ISO200/m), Angles of coverage: 18mm lens angle of view (equivalent to 28mm in 35mm format), Flash synchronization speed range at 1/150 sec. and a slower speed, Daylight-sync flash, Slow-speed-sync flash, Contrast-control-sync flash (ISO range = P-TTL: 200-3200 / TTL: 200-800).
Flash sync	Hot shoe with X-contact, which couples with Pentax dedicated auto flashes, ISO range = P-TTL: 200-3200 / TTL: 200-800, Automatic flash, Red-eye reduction flash function, High-speed-sync, wireless-sync with PENTAX dedicated flash.
Custom Function	22 functions can be set.
Time function	World Time settings for 62 cities (28 time zones)
Power Source	Two CR-V3, four AA lithium batteries, AA Ni-MH rechargeable, or AA alkaline batteries.
Battery Exhaustion	Battery exhaustion symbol  is lit. The shutter is locked and no indication in the viewfinder when  starts blinking.
I / O Port	USB / Video terminal (PC communication USB1.1), external power supply terminal
Video Output format	NTSC / PAL
Dimension and Weight	129mm (W) × 94.5mm (H) × 60mm (D) (5.1"×3.7"×2.4") 550g (19.4 oz) body only without batteries
Accessories	Hot shoe cover FK, Eyecup FL, ME viewfinder cap, Body mount cover, USB Cable I-USB2, Video cable I-VC2, Software (CD-ROM) S-SW10, Strap O-ST10, Two CR-V3 lithium batteries, CR2016 lithium battery, Operating manual (this book) and PENTAX PHOTO Browser/PENTAX PHOTO Laboratory operating manual.

Specification for Remote Control (Optional)

Remote Control	The operating distance of the remote control is approx. 5 m from the front of the camera.
Power source	One 3V lithium battery (CR1620)
Dimension	22mm(W) × 53mm(H) × 6.5mm(D)
Weight	7g

Program lines

Normal Program (FA J 18-35mm f4-5.6)

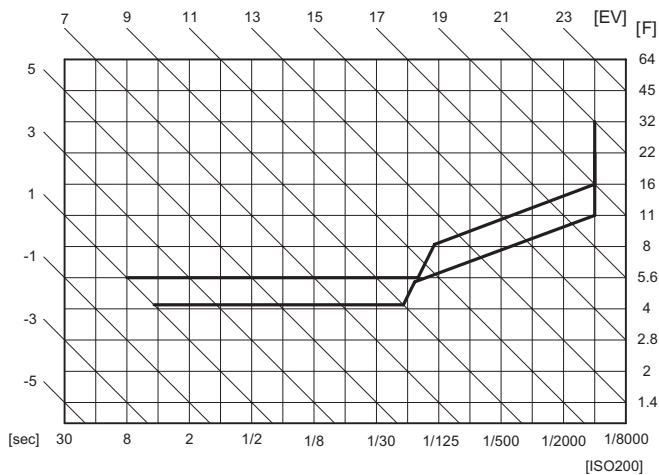

High-speed priority program (FA J 18-35mm f4-5.6)

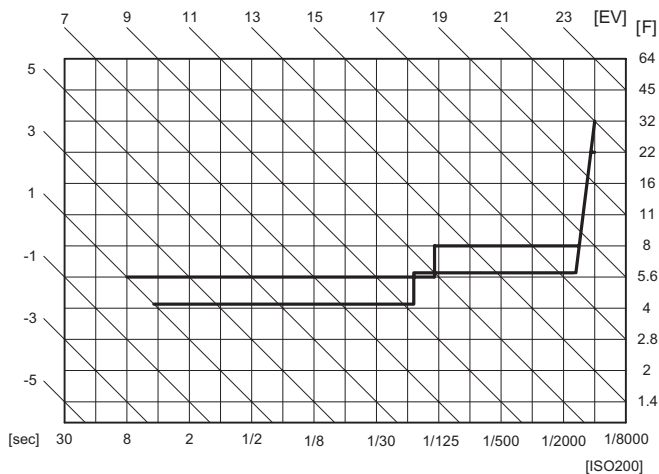

Depth-of-field priority program (FA J 18-35mm f4-5.6)

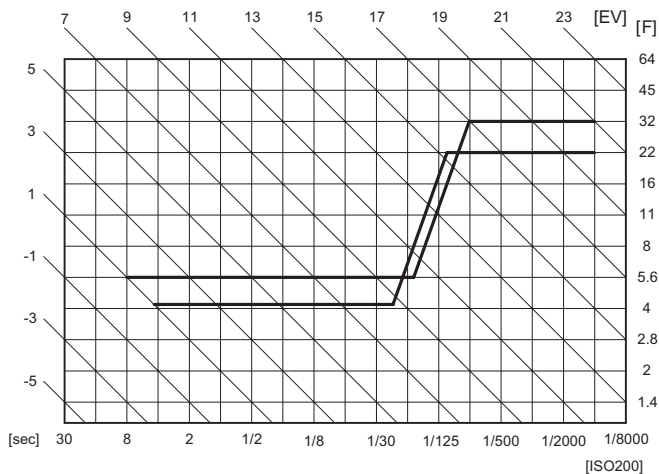

MTF priority program (FA J 18-35mm f4-5.6)

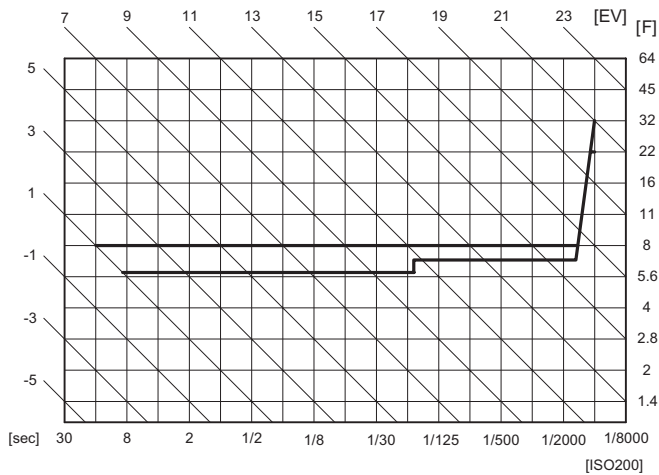

CCD (Charge Coupled Device)

Photography element which converts the light entering through the lens into electric signals.

DCF (design rule for camera file system)

An image file standard established by the Japan Electronics and Information Technology Industries Association (JEITA).

DPOF (digital print order format)

Rules for writing information onto a card with recorded images, regarding the specific images and number of copies to be printed. Prints can easily be made by taking this to a DPOF photo printing store.

JPEG

An image compression method. The image is recorded in JPEG format when the quality level is set to ★★★ (Best), ★★ (Better), or ★ (Good). Images recorded in JPEG format are suited for viewing on your PC or for attaching to an e-mail.

NTSC / PAL

These are video output formats. NTSC is mainly used in Japan, North America, and South Korea. PAL is mainly used in European nations and in China.

RAW data

Image data recording raw output from the CCD. Transfer RAW data to your computer and use the provided software to create image data with different settings, such as JPEG or TIFF.

sRGB (standard RGB)

International standard of color space established by the IEC (International Electrotechnical Commission). By using sRGB compliant color adjustments on peripheral devices for PCs, such as digital cameras, printers, and monitors, differences in color during input and output are reduced.

TIFF

A format for saving image data in a non-compressed format. Image data using this format has a large file size and is not suited for attaching to e-mail, but is suited for processing on your PC.

Color Temperature

This numerically expresses the color of the light source illuminating the subject. This is indicated in absolute temperature, using Kelvin (K) units. The color of light shifts to a bluish color as the color temperature rises, and to a reddish color as the color temperature falls.

Color space

A system that organizes colors. Colors displayed on displays for PCs and televisions are rendered with combinations of RGB (red, green, blue), and those for color printed materials, such as pamphlets, are rendered with combinations of CMYK (cyan, magenta, yellow, black). Color space is the method in which specific colors are rendered through a certain method.

Quality Level

This refers to the image compression ratio. The lower the compression, the more detailed the image. The image becomes rougher as the compression rate rises.

Recorded Pixels

Indicates the size of the image by the number of pixels. The more pixels that compose a picture, the larger the image size.

Histogram

Graphed presentation of a gradation sequence that shows the darkest point in an image to the brightest. The horizontal axis represents the brightness and the vertical axis represents the number of pixels. This is useful when you wish to refer to the exposure status of an image.

All PENTAX cameras purchased through authorized bona fide photographic distribution channels are guaranteed against defects of material or workmanship for a period of twelve months from date of purchase. Service will be rendered, and defective parts will be replaced without cost to you within that period, provided the equipment does not show evidence of impact, sand or liquid damage, mishandling, tampering, battery or chemical corrosion, operation contrary to operating instructions, or modification by an unauthorized repair shop. The manufacturer or its authorized representatives shall not be liable for any repair or alterations except those made with its written consent and shall not be liable for damages from delay or loss of use or from other indirect or consequential damages of any kind, whether caused by defective material or workmanship or otherwise; and it is expressly agreed that the liability of the manufacturer or its representatives under all guarantees or warranties, whether expressed or implied, is strictly limited to the replacement of parts as hereinbefore provided. No refunds will be made on repairs by nonauthorized PENTAX service facilities.

Procedure During 12-month Warranty Period

Any PENTAX which proves defective during the 12-month warranty period should be returned to the dealer from whom you purchased the equipment or to the manufacturer. If there are no representatives of the manufacturer in your country, send the equipment to the manufacturer, with postage prepaid. In this case, it will take a considerable length of time before the equipment can be returned to you owing to the complicated customs procedures required. If the equipment is covered by warranty, repairs will be made and parts replaced free of charge, and the equipment will be returned to you upon completion of servicing. If the equipment is not covered by warranty, regular charges of the manufacturer or of its representatives will apply. Shipping charges are to be borne by the owner. If your PENTAX was purchased outside of the country where you wish to have it serviced during the warranty period, regular handling and servicing fees may be charged by the manufacturer's representatives in that country. Notwithstanding this, your PENTAX returned to the manufacturer will be serviced free of charge according to this procedure and warranty policy. In any case, however, shipping charges and customs clearance fees to be borne by the sender. To prove the date of your purchase when

required, please keep the receipt or bills covering the purchase of your equipment for at least a year. Before sending your equipment for servicing, please make sure that you are sending it to the manufacturer's authorized representatives or their approved repair shops, unless you are sending it directly to the manufacturer. Always obtain a quotation for the service charge, and only after you accept the quoted service charge, instruct the service station to proceed with the servicing.

- **This warranty policy does not affect the customer's statutory rights.**
- **The local warranty policies available from PENTAX distributors in some countries can supersede this warranty policy. Therefore, we recommend that you review the warranty card supplied with your product at the time of purchase, or contact the PENTAX distributor in your country for more information and to receive a copy of the warranty policy.**

For customers in USA

STATEMENT OF FCC COMPLIANCE

This device complies with Part 15 of the FCC Rules. Operation is subject to the following two conditions: (1) This device may not cause harmful interference, and (2) this device must accept any interference received, including interference that may cause undesired operation. Changes or modifications not approved by the party responsible for compliance could void the user's authority to operate the equipment.

This equipment has been tested and found to comply with the limits for a Class B digital device, pursuant to part 15 of the FCC Rules.

These limits are designed to provide reasonable protection against harmful interference in a residential installation. This equipment generates, uses and can radiate frequency energy and, if not installed and used in accordance with the instructions, may cause harmful interference to radio communications. However, there is no guarantee that interference will not occur in a particular installation.

If this equipment does cause harmful interference to radio or television reception, which can be determined by turning the equipment off and on, the user is encouraged to try to correct the interference by one or more of the following measures:

- Reorient or relocate the receiving antenna.
- Increase the separation between the equipment and receiver.
- Connect the equipment into an outlet on a circuit different from that to which the receiver is connected.

* Consult the dealer or an experienced radio / TV technician for help.

For customers in Canada

This Class B digital apparatus meets all requirements of the Canadian Interference - Causing Equipment Regulations.

Pour les utilisateurs au Canada

Cet appareil numérique de la classe B respecte toutes les exigences du Règlement sur le matériel brouilleur du Canada.



The CE Mark is a Directive conformity mark of the European Community.

Declaration of Conformity

According to 47CFR, Parts 2 and 15 for
Class B Personal Computers and Peripherals

We: PENTAX U.S.A., Inc.
Located at: 600 12th Street, Suite 300
Golden, Colorado 80401 U.S.A
Phone: 303-799-8000 FAX: 303-790-1131

Declare under sole responsibility that the product identified herein, complies with 47CFR Parts 2 and 15 of the FCC rules as a Class B digital device. Each product marketed, is identical to the representative unit tested and found to be compliant with the standards. Records maintained continue to reflect the equipment being produced can be expected to be within the variation accepted, due to quantity production and testing on the statistical basis as required by 47CFR §2.909. Operation is subject to the following two conditions: (1) This device may not cause harmful interference, and (2) This device must accept any interference received, including interference that may cause undesired operation. The above named party is responsible for ensuring that the equipment complies with the standards of 47CFR §15.101 to §15.109.

Product Name: PENTAX Digital Still Camera
Model Number: **istD*
Contact person: Customer Service Manager
Date and Place: Aug., 2003, Colorado

PENTAX Corporation	2-36-9, Maeno-cho, Itabashi-ku, Tokyo 174-8639, JAPAN (http://www.pentax.co.jp/)
PENTAX Europe GmbH (European Headquarters)	Julius-Vosseler-Strasse, 104, 22527 Hamburg, GERMANY (HQ - http://www.pentaxeurope.com) (Germany - http://www.pentax.de)
PENTAX U.K. Limited	PENTAX House, Heron Drive, Langley, Slough, Berks SL3 8PN, U.K. (http://www.pentax.co.uk)
PENTAX France S.A.S.	12/14, rue Jean Poulmarch, 95106 Argenteuil Cedex, FRANCE
PENTAX Benelux B.V.	(for Netherlands) Spinveld 25, 4815 HR Breda, NETHERLANDS (http://www.pentax.nl) (for Belgium & Luxembourg) Weiveldlaan 3-5, 1930 Zaventem, BELGIUM (http://www.pentax.be)
PENTAX (Schweiz) AG	Widenholzstrasse 1 Postfach 367 8305 Dietlikon, SWITZERLAND (http://www.pentax.ch)
PENTAX Scandinavia AB	P.O. Box 650, 75127 Uppsala, SWEDEN (http://www.pentax.se)
PENTAX U.S.A., Inc	600 12 th Street, Suite 300 Golden, Colorado 80401 U.S.A. (http://www.pentax.com)
PENTAX Canada Inc.	3131 Universal Drive, Mississauga, Ontario L4X 2E5, CANADA (http://www.pentaxcanada.ca)



- Printed on recycled paper
- Specifications and external dimensions are subject to change without notice.