

PENTAX



SLR Digital Camera

K-m/K 2000

Operating Manual

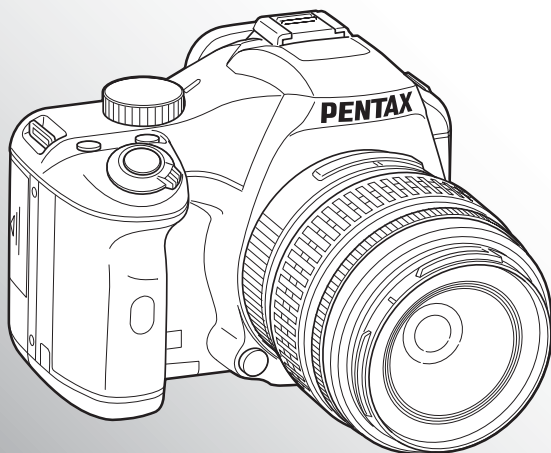

For optimum camera performance, please read the Operating Manual before using the camera.

Thank you for purchasing this PENTAX *K-m/K2000* Digital Camera. Please read this manual before using the camera in order to get the most out of all the features and functions. Keep this manual safe, as it can be a valuable tool in helping you to understand all the camera capabilities.

Lenses you can use

In general, lenses that can be used with this camera are DA, DA L, D FA and FA J lenses and lenses that have an Aperture **A** (Auto) position.

To use any other lens or accessory, see p.46 and p.240.

Regarding copyrights

Images taken using the *K-m/K2000* that are for anything other than personal enjoyment cannot be used without permission according to the rights as specified in the Copyright Act. Please take care, as there are cases where limitations are placed on taking pictures even for personal enjoyment during demonstrations, performances or of items on display. Images taken with the purpose of obtaining copyrights also cannot be used outside the scope of use of the copyright as laid out in the Copyright Act, and care should be taken here also.

Regarding trademarks

PENTAX, K-m/K2000 and smc PENTAX are trademarks of HOYA CORPORATION. PENTAX PHOTO Browser, PENTAX PHOTO Laboratory and SDM are trademarks of HOYA CORPORATION.

 SDHC logo is a trademark.

This product includes DNG technology under license by Adobe Systems Incorporated.

 The DNG logo is either registered trademarks or trademarks of Adobe Systems Incorporated in the United States and/or other countries.

All other brands or product names are trademarks or registered trademarks of their respective companies.

To users of this camera

- There is a possibility that recorded data may be erased or that the camera may not function correctly when used in surroundings such as installations generating strong electromagnetic radiation or magnetic fields.
- The liquid crystal panel used in the monitor is manufactured using extremely high precision technology. Although the level of functioning pixels is 99.99% or better, you should be aware that 0.01% or fewer of the pixels may not illuminate or may illuminate when they should not. However, this has no effect on the recorded image.

This product supports PRINT Image Matching III. PRINT Image Matching enabled digital still cameras, printers and software help photographers to produce image more faithful to their intentions. Some functions are not available on printers that are not PRINT Image Matching III compliant.

Copyright 2001 Seiko Epson Corporation. All Rights Reserved.

PRINT Image Matching is a trademark of Seiko Epson Corporation.

The PRINT Image Matching logo is a trademark of Seiko Epson Corporation.

Regarding PictBridge

PictBridge allows the user to connect the printer and digital camera directly, using the unified standard for the direct printout of images. You can print images directly from the camera through a few simple operations.

- There is a possibility that the illustrations and the display screen of the monitor in this manual are different from the actual product.

FOR USING YOUR CAMERA SAFELY

We have paid close attention to the safety of this product. When using this product, we request your special attention regarding items marked with the following symbols.



Warning

This symbol indicates that violating this item could cause serious personal injuries.



Caution

This symbol indicates that violating this item could cause minor or medium personal injuries, or material losses.

ABOUT THE CAMERA



Warning

- Do not disassemble or modify the camera. High voltage areas are present inside the camera, with the risk of electric shock.
- If the camera interior is exposed due to dropping or otherwise damaging the camera, never touch the exposed portion. There is the risk of electric shock.
- To avoid the risk of it being swallowed by mistake, keep the SD Memory Card out of the reach of small children. Seek medical attention immediately if a memory card is accidentally swallowed.
- Wrapping the strap around your neck is dangerous. Take care that small children do not hang the strap over their necks.
- Do not look directly at the sun through the camera with a telephoto lens attached, as viewing the sun may damage your eyes. Viewing the sun directly with a telephoto lens may lead to a loss of eyesight.
- Be sure to store the batteries out of the reach of children. Placing them in mouth may cause an electrical shock.
- Always use the AC adapter exclusively developed for this product, with the specified power and voltage. Using an AC adapter not exclusive to this product, or using the exclusive AC adapter with an unspecified power or voltage can cause a fire, electric shock, or camera breakdown.
- If any irregularities occur during use, such as smoke or a strange odor, stop use immediately, remove the batteries or the AC adapter, and contact your nearest PENTAX Service Center. Continued use could cause a fire or electric shock.
- During thunderstorms, unplug and discontinue use of the AC adapter. Continued use could cause equipment failure, a fire or electric shock.



Caution

- Do not short the batteries or dispose of the batteries in fire. Do not disassemble the batteries. The batteries could explode or catch fire.
- Of the batteries that can be used in this camera (AA Ni-MH batteries, AA lithium batteries and AA alkaline batteries), only the Ni-MH batteries can be recharged. Recharging other batteries can cause a fire or explosion.
- Remove the batteries from the camera immediately if they become hot or begin to smoke. Be careful not to burn yourself during removal.
- Some portions of the camera heat up during use. There is the risk of low temperature burns when holding such portions for long periods.
- Do not place your finger over or cover the flash with clothing when discharging the flash. Fingers or clothing may be burned.
- To reduce the risk of hazards, use only CSA/UL Certified power supply cord set, cord is Type SPT-2 or heavier, minimum NO.18 AWG copper, one end with a molded-on male attachment plug cap (with a specified NEMA configuration), and the other is provided with a molded-on female connector body (with a specified IEC nonindustrial type configuration) or the equivalent.

PRECAUTIONS FOR BATTERY USAGE

- Only use the specified batteries with this camera. Use of other batteries can cause a fire or explosion.
- Replace all the batteries at the same time. Do not mix battery brands, type or an old battery with a new one. It may cause explosion or a fire.
- The batteries should be inserted correctly with regard to polarity (+ and -) marked on the batteries and the camera. Not inserting batteries correctly may cause explosion or a fire.
- Do not disassemble the batteries. Of the batteries that can be used in this camera, only the AA Ni-MH batteries can be recharged. Disassembling the batteries or attempting to charge non-rechargeable batteries could result in explosion or leakage.

Care to be Taken During Handling

- When traveling, take the Worldwide Service Network that is included in the package. This will be useful if you experience problems abroad.

- When the camera has not been used for a long time, confirm that it is still working properly, particularly prior to taking important pictures (such as at a wedding or during traveling). Pictures cannot be guaranteed if recording, playback or transferring your data to a computer, etc. is not possible due to a malfunction of your camera or recording media (SD Memory Card), etc.
- Do not clean the product with organic solvents such as thinner, alcohol or benzene.
- Do not subject the camera to high temperatures or high humidity. Do not leave the camera in a vehicle, as the temperature can get very high.
- Do not store the camera with preservatives or chemicals. Storage in high temperatures and high humidity can cause mold to grow on the camera. Remove from the case and store in a dry and well-ventilated location.
- Do not subject the camera to strong vibrations, shocks, or pressure. Use a cushion to protect the camera from vibrations of motorcycles, automobiles, or ships.
- The temperature range for camera use is 0°C to 40°C (32°F to 104°F).
- The monitor may appear black under high temperatures, but will return to normal as temperatures normalize.
- The monitor may respond more slowly at low temperatures. This is due to liquid crystal properties, and is not a fault.
- Periodic inspections are recommended every one to two years to maintain high performance.
- Sudden temperature changes will cause condensation on the inside and outside of the camera. Place the camera in your bag or a plastic bag, and remove the camera after temperature of the camera and surroundings are equalized.
- Avoid contact with garbage, mud, sand, dust, water, toxic gases, or salts. These could cause a camera breakdown. Wipe dry any rain or water drops on the camera.
- Refer to "Precautions When Using the SD Memory Card" (p.43) regarding the SD Memory Card.
- Use a lens brush to remove dust accumulated on the lens or viewfinder. Never use a spray blower for cleaning as it may damage the lens.
- Please contact PENTAX Service Center for professional cleaning of the CCD. (This will involve a fee.)
- Please do not press forcefully on the monitor. This could cause breakage or malfunction.
- Depending on a user's physical condition, some users may experience itching, break out in a rash or suffer from eczema. If an abnormality occurs, immediately discontinue using the camera and seek medical attention.

Regarding Product Registration

In order to better serve you, we request that you complete the product registration, which can be found on the CD-ROM supplied with the camera or on the PENTAX website. Thank you for your cooperation.

Refer to the PENTAX PHOTO Browser 3/PENTAX PHOTO Laboratory 3 Operating Manual for more information.

Contents

FOR USING YOUR CAMERA SAFELY	1
ABOUT THE CAMERA	1
PRECAUTIONS FOR BATTERY USAGE	2
Care to be Taken During Handling	2
Contents	5
Composition of the Operating Manual	11
Before Using Your Camera	13
<i>K-m/K2000</i> Camera Characteristics	14
Checking the Contents of the Package	16
Names and Functions of Working Parts	17
Capture Mode	18
Playback Mode	20
Display Indicators	22
Monitor	22
Viewfinder	28
How to Change Function Settings	30
Using Direct Keys	30
Using the Control Panel	31
Using the Menu	32
Using the Help Function	34
Getting Started	35
Attaching the Strap	36
Inserting the Batteries	37
Battery Level Indicator	39
Approximate Image Storage Capacity and Playback Time (New Batteries)	39
Using the AC Adapter (Optional)	40
Inserting/Removing the SD Memory Card	42
Recorded Pixels and Quality Level	44
Attaching the Lens	46
Adjusting the Viewfinder Diopter	48
Turning the Camera On and Off	49
Initial Settings	50
Setting the Display Language	50
Setting the Date and Time	54

Basic Operations

57

Basic Shooting Operation	58
Holding the Camera	58
Letting the Camera Choose the Optimal Settings	59
Using a Zoom Lens	64
Using the Built-in Flash	65
Setting Flash Mode	65
Compensating Flash Output	70
Allowing Shooting while Charging the Flash	71
Playing Back Pictures	72
Playing Back Images	72
Deleting Images	73

Shooting Functions

75

How to Operate the Shooting Functions	76
Direct Keys Setting Items	76
Rec. Mode Menu Setting Items	77
Custom Setting Menu Setting Items	78
Selecting the Appropriate Capture Mode	80
Picture Mode	81
SCN Mode	82
Exposure Mode	84
Setting the Exposure	85
Effect of Aperture and Shutter Speed	85
Setting the Sensitivity	87
Changing the Exposure Mode	89
Selecting the Metering Method	101
Adjusting the Exposure	104
Focusing	109
Using the Autofocus	109
Setting the AF Mode	111
Selecting the Focusing Area (AF Point)	113
Fixing the Focus (Focus Lock)	114
Adjusting the Focus Manually (Manual Focus)	116
Checking the Composition, Exposure and Focus Before Shooting (Digital Preview)	119

Using Shake Reduction Function to Prevent Camera Shake	121
Taking Pictures Using the Shake Reduction Function	121
Shooting with the Self-Timer	125
Shooting with the Remote Control (Optional)	128
Continuous Shooting	130
Taking Pictures Using Digital Filters	132
Using the Flash	135
<hr/>	
Flash Characteristics in Each Exposure Mode	136
Using Slow-Speed-Sync	136
Distance and Aperture when Using the Built-in Flash	138
Lens Compatibility with the Built-in Flash	139
Using an External Flash (Optional)	140
Shooting Settings	149
<hr/>	
Setting the File Format	150
Setting the JPEG Recorded Pixels	150
Setting the JPEG Quality Level.....	151
Setting the File Format.....	152
Setting the  Button Function	154
Setting the Image Finishing Tone (Custom Image)	157
Additional Settings for Shooting	159
Setting the White Balance.....	159
Setting the Color Space	164
Playback Functions	165
<hr/>	
Playback Functions Operation	166
Playback Menu Setting Items	166
Enlarging Images	167
Displaying Multiple Images	169
Multi-image Display Screen	169
Calendar Display/Folder Display.....	171
Joining Multiple Images (Index)	172
Rotating Images	175
Comparing Images	176
Slideshow	177
Setting the Slideshow Display.....	177
Starting the Slideshow	178

Deleting Multiple Images	180
Deleting Selected Images	180
Deleting a Folder	182
Deleting All Images	183
Protecting Images from Deletion (Protect)	184
Protecting Single Images	184
Protecting All Images	185
Connecting the Camera to AV Equipment	186
Processing Images	187
<hr/>	
Changing the Image Size	188
Changing the Number of Recorded Pixels and Quality Level (Resize)	188
Cutting Out Part of the Image (Cropping)	190
Processing Images with Digital Filters	192
Editing RAW Images	195
Editing a RAW Image	195
Printing from the Camera	199
<hr/>	
Setting the Printing Service (DPOF)	200
Printing Single Images	200
Settings for All Images	202
Printing Using PictBridge	203
Setting USB Connection	204
Connecting the Camera to the Printer	205
Printing Single Images	206
Printing All Images	208
Printing Images Using the DPOF Settings	209
Disconnecting the USB Cable	209

Camera Settings 211

How to Operate the Set-up Menu	212
Set-up Menu Setting Items	212
Formatting the SD Memory Card	214
Setting the Beep Setting, Date and Time, and Display Language.....	215
Turning the Beep On and Off.....	215
Changing the Date and Time and the Display Style	216
Setting the World Time	216
Setting the Display Language	219
Adjusting the Monitor and the Menu Display	220
Setting the Text Size	220
Setting the Guide Display Time	220
Setting the Status Display	221
Adjusting the Brightness of the Monitor	221
Adjusting the Color of the Monitor	222
Setting the Display for Instant Review	222
Setting the Folder Name/File Number Naming Convention ...	224
Selecting the Folder Name	224
Selecting the File Number Setting	224
Selecting the Video Output Format and Power Settings	225
Selecting the Video Output Format.....	225
Setting Auto Power Off	225
Setting the Battery Type	226
Setting the Operation of the Power Lamp.....	227
Using Pixel Mapping	228
Selecting Capture Mode Settings to Save in the Camera.....	229
Resetting to Default Settings 231	
<hr/>	
Resetting Rec. Mode/Playback/Set-up Menu	232
Resetting the Custom Menu	233

Default Settings	236
Functions Available with Various Lens Combinations	240
Notes on [19. Using Aperture Ring]	241
Cleaning the CCD	243
Removing Dust by Shaking the CCD (Dust Removal)	243
Detecting Dust on the CCD (Dust Alert)	244
Removing Dust with a Blower	246
Optional Accessories	248
Error Messages	252
Troubleshooting	255
Main Specifications	258
Glossary	262
Index	267
WARRANTY POLICY	272

Composition of the Operating Manual

This Operating Manual contains the following chapters.

1 Before Using Your Camera

Explains camera characteristics, accessories and the names and functions of various parts.

2 Getting Started

Explains your first steps from purchasing the camera to taking pictures. Be sure to read it and follow the instructions.

3 Basic Operations

Explains the procedures for taking and playing back pictures.

4 Shooting Functions

Explains the shooting-related functions.

5 Using the Flash

Explains how to use the built-in flash and the external flash.

6 Shooting Settings

Explains the procedures for configuring image processing and setting the file format.

7 Playback Functions

Explains the procedures for playing back, deleting, and protecting pictures.

8 Processing Images

Explains the procedures for changing the image size, using image filters and processing pictures taken in RAW format.

9 Printing from the Camera

Explains the procedures for setting the print settings and printing pictures while directly connected to a printer.

10 Camera Settings

Explains the procedures for changing the camera settings, such as the monitor settings and the image file naming convention.

11 Resetting to Default Settings

Explains the procedure for resetting all settings to their default settings.

12 Appendix

Explains troubleshooting, introduces optional accessories and provides various resources.

1

2

3

4

5

6

7

8



9

10

11

12

The symbols used in this Operating Manual are explained below.



	Shows reference page number explaining a related operation.
	Shows useful information.
	Shows precautions to take when operating the camera.

1 Before Using Your Camera

Check the package contents and names and functions of working parts before use.

<i>K-m/K2000</i> Camera Characteristics	14
Checking the Contents of the Package	16
Names and Functions of Working Parts	17
Display Indicators	22
How to Change Function Settings	30
Using the Help Function	34

K-m|K2000 Camera Characteristics

- Features a 23.5×15.7 mm CCD with approximately 10.2 million effective pixels for high precision and a wide dynamic range.
- Features Shake Reduction (SR), an image sensor shifting shake reduction system. This enables you to capture sharp pictures with minimal camera shake regardless of the lens type.
- Features a viewfinder similar to that of a conventional 35 mm camera, with a magnification of approximately 0.85 and field of view of approximately 96%, for easier manual focusing.
- Features a large 2.7-inch monitor with approximately 230,000 dots, a wide viewing angle and brightness and color adjusting functions for high-precision viewing performance.
- Uses AA lithium batteries, rechargeable AA Ni-MH batteries or AA alkaline batteries.
- Features a help function that lets you check how to use the camera while using it. If you do not know how to use a certain function, press the  (Help) button to display its explanation on the monitor. When you are already familiar with the camera's operation, you can also assign 4 other functions to the  button making the camera's setup more convenient.
- A user-friendly design has been implemented in various parts of the camera. The large text, high-contrast monitor and easy-to-use menus make the camera easier to operate.
- The CCD features a special SP coating against dust deposit. The Dust Removal function also shakes the CCD for removing collected dust.
- Features Digital Filters to internally process the image in the camera. You can use digital filters like B&W or Soft while taking pictures or to process images after taking pictures.
- Features Custom Image which allows you to adjust settings while previewing the edited image, enabling a wider range of expression.
- Records in the versatile JPEG format or the high quality and fully editable RAW format. You can also select JPEG+RAW and record in both formats. Pictures taken in RAW format can be easily processed internally by the camera.
- Features Sensitivity Priority mode **Sv** that automatically adjusts aperture and shutter speed according to the set sensitivity.

The captured area (view angle) will differ between the *K-m/K2000* and 35 mm SLR cameras even if the same lens is used because the format size for 35 mm film and CCD are different.

Sizes for 35 mm film and CCD

35 mm film : 36×24 mm
K-m/K2000 CCD : 23.5×15.7 mm

Angles of view being equal, the focal length of a lens used with a 35 mm camera must be approximately 1.5 times longer than that of *K-m/K2000*. To obtain an angle of view framing the same area, divide the focal length of the 35 mm lens by 1.5.

Example) To capture the same image as a 150 mm lens attached to a 35 mm camera

$$150 \div 1.5 = 100$$

Use a 100 mm lens with the *K-m/K2000*.

Inversely, multiply the focal length of the lens used with the *K-m/K2000* by 1.5 to determine the focal length for 35 mm cameras.

Example) If 300 mm lens is used with the *K-m/K2000*

$$300 \times 1.5 = 450$$

Focal length is equivalent to a 450 mm lens on a 35 mm camera.

Shake Reduction (SR)

Shake Reduction (SR) on the *K-m/K2000* features a PENTAX original system which uses magnetic force to move the image sensor at high speeds, compensating camera shake.

The camera may generate some operating noise when it is shaken, such as when changing the composition of a picture. It is not a malfunction.

Help Function

The guides displayed for the *K-m/K2000* help function have been designed for use in combination with a DA or DA L lens.

When using another lens with the aperture ring not set to the **A** (Auto) position, some of the guides displayed may not match the actual conditions.

Checking the Contents of the Package

The following accessories are packaged with your camera.
Check that all accessories are included.

1

Before Using Your Camera



Hot shoe cover F_K
(Installed on camera)

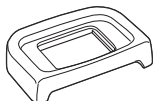

Eyecup F_α
(Installed on camera)

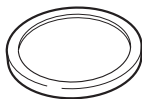

Body mount cover
(Installed on camera)

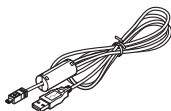

USB cable
I-USB7

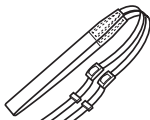

Strap
O-ST84



Software (CD-ROM)
S-SW84



Four AA lithium batteries



Operating Manual
(this manual)



Quick Guide



PENTAX PHOTO Browser 3/
PENTAX PHOTO Laboratory 3
Operating Manual

Names and Functions of Working Parts

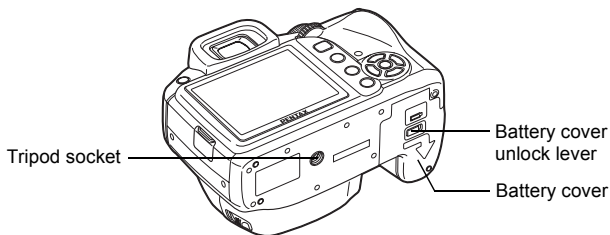
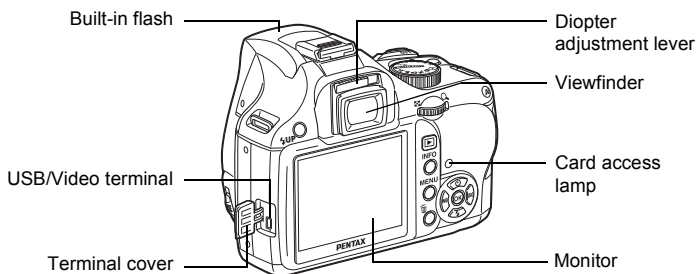
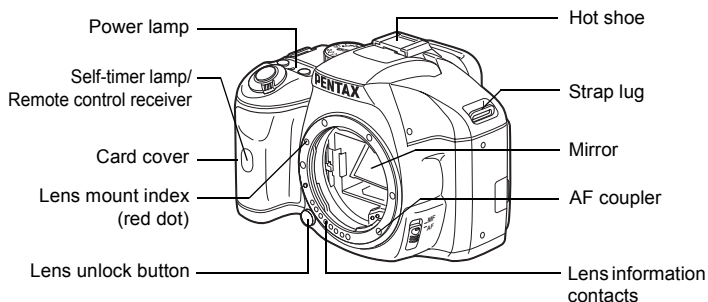

* In the second illustration, the camera is shown with the Eyecup F₀ removed.

Capture Mode

Functions of buttons, dials and levers used during shooting are noted.

1

Before Using Your Camera



The factory default settings are explained here. Depending on the button, these settings can be changed.

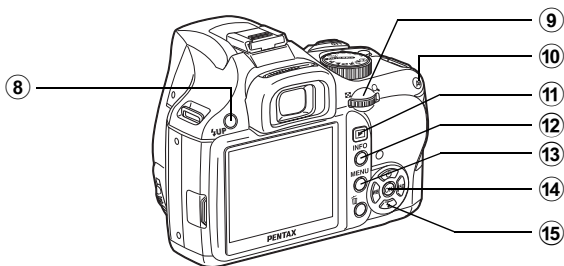
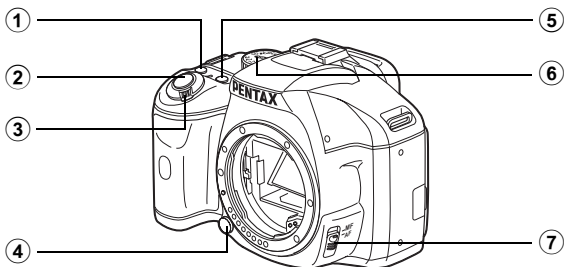

- ① **?** (Help) button
Displays an explanation of the function or operation on the monitor. (p.34)
You can also assign other functions to this button. (p.154)
- ② **Shutter release button**
Press to capture images. (p.62)
- ③ **Main switch**
Move to turn the power on/off. (p.49)
- ④ **Lens unlock button**
Press to detach lens. (p.47)
- ⑤ **Av button**
Sets the EV compensation and aperture values. (p.91, p.98, p.104)
- ⑥ **Mode dial**
Changes Capture mode. (p.80)
- ⑦ **Focus mode lever**
Switches between autofocus mode (p.109) and manual focus mode (p.116).
- ⑧ **UP button**
Press to pop up the built-in flash. (p.65)
- ⑨ **e-dial**
Sets the shutter speed, aperture, sensitivity and EV compensation values.
- ⑩ **AF button**
You can select the function of this button either to focus on the target or to memorize the exposure value. (p.100, p.105, p.110)
- ⑪ **▶ button**
Switches to Playback mode. (p.72, p.166)
- ⑫ **INFO button**
Turns the status screen display on the monitor on/off. (p.23)
- ⑬ **MENU button**
Displays the [Rec. Mode 1] menu (p.77). Next, press the four-way controller (▶) to display other menus.
- ⑭ **OK button**
Displays the control panel (p.23). When the control panel or a menu screen is displayed, press the button to confirm the selected item.
- ⑮ **Four-way controller (▲▼◀▶)**
Opens the Drive Mode/Flash Mode/White Balance/Sensitivity setup menu (p.76). When the control panel or a menu screen is displayed, use this to move the cursor or change items.

Playback Mode

Functions of buttons, dials and levers used during playback are noted.

1

Before Using Your Camera

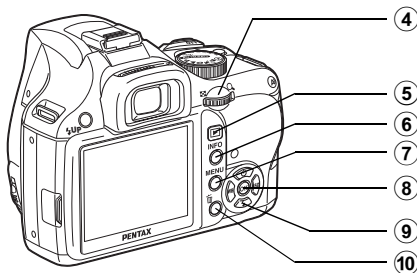
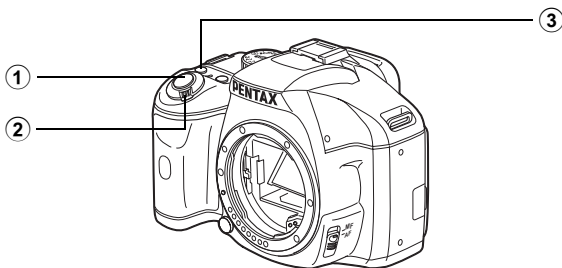

- ① **Shutter release button**
Press halfway to switch to Capture mode.
- ② **Main switch**
Move to turn the camera on and off. (p.49)
- ③ **🔍 (Help) button**
Displays an explanation of the function or operation on the monitor. (p.34)
- ④ **e-dial**
Use this to enlarge an image (p.167) or display multiple images at the same time (p.169).
- ⑤ **▶ button**
Press to switch to Capture mode.
- ⑥ **INFO button**
Press to show shooting information on the monitor. (p.24)
- ⑦ **MENU button**
Press to display the [▶ Playback 1] menu (p.166). Next, press the four-way controller (▶) to display other menus.
- ⑧ **OK button**
Saves the setting you selected in the menu or playback screen.
- ⑨ **Four-way controller (▲▼◀▶)**
Use this to move the cursor or change items in the menu or playback screen.
- ⑩ **🗑 button**
Press to delete images. (p.73)

References to Button Names

In this Operating Manual, the buttons of the four-way controller are referred to in the following way.

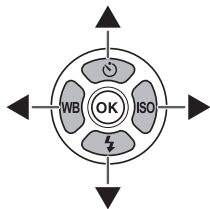

Monitor

The following indicators appear on the monitor depending on the status of the camera.

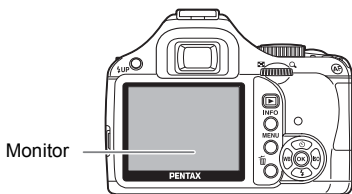

The brightness or the color of the monitor can be adjusted. (p.221, p.222)

At Start-up or when Operating the Mode Dial

Guides appear on the monitor for 3 seconds (default setting) when the camera is switched on or the mode dial is turned.



Select Off for [Guide display] in [↖ Set-up 1] menu to not show indicators. (p.220)

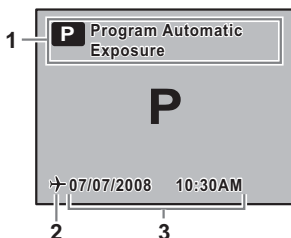

- | | |
|---|---------------------------------------|
| <p>1 Capture mode (p.80)</p> <p>2 World time (p.216)
(only when set to Destination)</p> | <p>3 Current date and time (p.54)</p> |
|---|---------------------------------------|

Capture Mode

While shooting, the status screen is displayed showing the current shooting function settings. Press the **OK** button to display the control panel and change settings.

● Status screen/Control panel

(The items are displayed here for explanatory purposes. The Actual display may differ.)

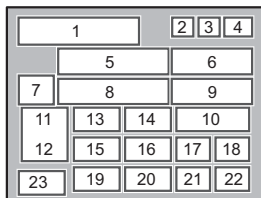
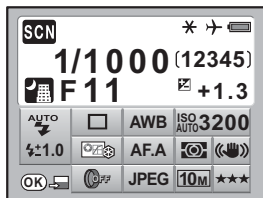

OK ↓ ↑ **INFO**

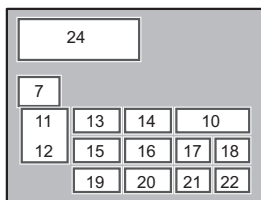

- | | |
|--|--|
| <ul style="list-style-type: none"> 1 Capture mode (p.80) 2 AE lock icon (p.105) 3 World Time (p.216) 4 Battery level (p.39) 5 Shutter speed (p.85) 6 Recordable image number 7 SCN (Scene) mode (p.82) 8 Aperture (p.85) 9 EV Compensation (p.104) 10 ISO Sensitivity (p.87) 11 Flash Mode (p.65) 12 Flash exposure compensation (p.70) | <ul style="list-style-type: none"> 13 Drive Mode (p.76) 14 White Balance (p.159) 15 Custom Image (p.157) 16 Focus mode (p.109) 17 AE metering (p.101) 18 Shake Reduction (p.121) 19 Digital Filter (p.132) 20 File format (p.152) 21 JPEG recorded pixels (p.150) 22 JPEG quality (p.151) 23 Guide key 24 Explanation of the selected function |
|--|--|



- Settings that cannot be changed due to the current camera setup cannot be selected.
- The status screen will disappear after the time set for [3. Meter Operating Time] in the [C Custom Setting 1] menu (the default setting is 10 seconds). Press the **INFO** button to display it again.
- When the [21. Display status] setting in the [C Custom Setting 3] menu is set to Off, the status screen is displayed only when the **INFO** button is pressed. (p.221)

Playback Mode

The camera switches display information when you press the **INFO** button during playback.

Standard	Captured images and indicators are displayed.
Histogram display	Images and histogram (Brightness/RGB) are displayed.
Detailed information display	Detailed showing of how and when the images were taken is displayed.
No info. display	Only captured images are displayed.

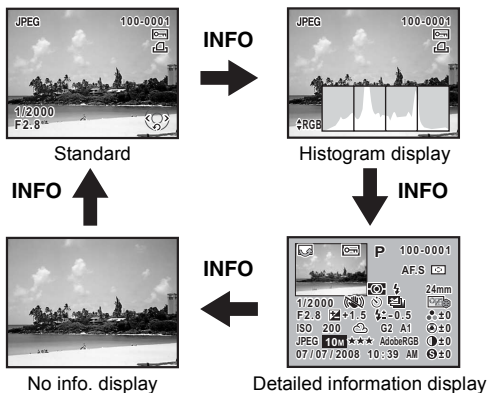

The information that is shown first during playback is the same as that of the last playback in the previous session. The [Standard] screen can always be displayed first by setting [Playback Display] to (Off) in [Memory] (p.229) in the [Rec. Mode 3] menu.

● Detailed information display

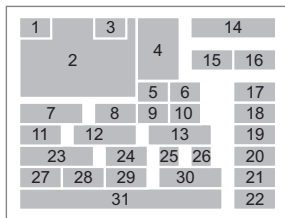
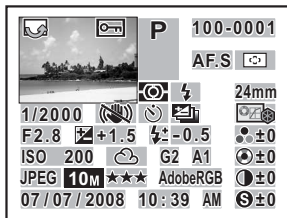

- | | |
|---------------------------------------|--|
| 1 Rotation information | 18 Image Tone |
| 2 Captured image | 19 Saturation/Filter Effect |
| 3 Protect setting | 20 Hue/Toning |
| 4 Capture mode | 21 Contrast |
| 5 AE metering | 22 Sharpness/Fine Sharpness |
| 6 Flash Mode | 23 Sensitivity |
| 7 Shutter speed | 24 White Balance |
| 8 Shake Reduction | 25 GM compensation (Adjust White Balance) |
| 9 Drive Mode | 26 BA compensation (Adjust White Balance) |
| 10 Exposure bracket | 27 File format |
| 11 Aperture | 28 JPEG recorded pixels |
| 12 EV Compensation | 29 JPEG quality |
| 13 Flash exposure compensation | 30 Color space |
| 14 Folder number-File number | 31 Shooting date/time |
| 15 Focus mode | |
| 16 AF area | |
| 17 Lens focal length | |

* Indicators 6 and 13 only appear for images in which the flash was discharged.

● Histogram Display

The *K-m/K2000* features two histogram displays. The “Brightness histogram” shows the distribution of brightness and the “RGB histogram” shows the distribution of color intensity. Press the four-way controller (▲▼) to switch between “Brightness histogram” and “RGB histogram”.

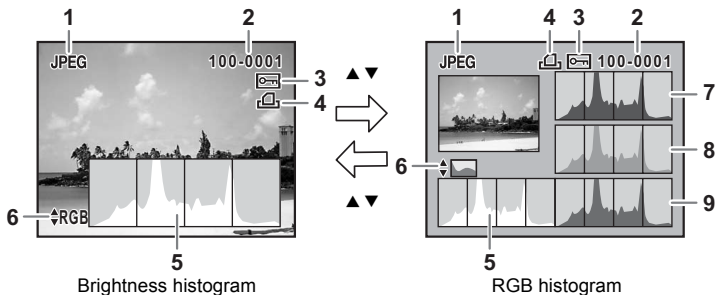

- | | |
|-------------------------------------|---|
| 1 File format | 6 Switch Brightness histogram/
RGB histogram |
| 2 Folder number-File number (p.224) | 7 Histogram (R) |
| 3 Protect setting (p.184) | 8 Histogram (G) |
| 4 DPOF settings (p.200) | 9 Histogram (B) |
| 5 Histogram (Brightness) (p.26) | |

* Indicator 3 only appears for images with Protect setting and indicator 4 only appears for images with DPOF settings.



Areas affected by bright or dark portions blink if [Bright/Dark area] warning is set to (On) in [Playback dsp. methd.] in the [▶ Playback 2] menu. (p.168)

Using the Histogram

A histogram shows the brightness distribution of an image. The horizontal axis represents brightness (dark at the left and bright at the right) and the vertical axis represents the number of pixels.

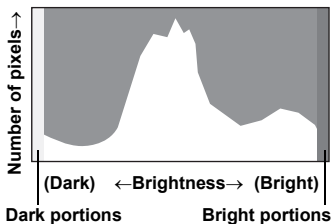

The shape and the distribution of the histogram before and after shooting tells you whether the exposure level and contrast are correct or not, and lets you decide if you need to use EV compensation and take a picture again.

☞ Adjusting the Exposure (p.104)

Understanding Brightness

When the brightness is correct and there are no overly light or dark areas, the graph peaks in the middle. If the image is too dark, the peak is on the left side, and if it is too bright, the peak is on the right side.



Dark image

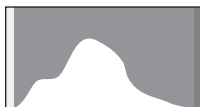
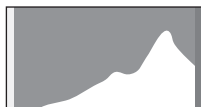

Image with few bright or dark areas



Bright image

When the image is too dark, the part to the left is cut off (dark portions with no detail) and when the image is too bright, the part to the right is cut off (bright portions with no detail).

Bright portions blink red on the monitor and dark portions blink yellow when [Bright/Dark area] is On.

☞ Playing Back Images (p.72)

☞ Setting the Display for Instant Review (p.222)

Understanding Color Balance

Distribution of color intensity is displayed for each color in the RGB histogram. The right side of the graphs look similar for images that have White Balance adjusted well. If only one color is lopsided to the left, that color is too intense.

☞ Setting the White Balance (p.159)

Viewfinder

The following information appears in the viewfinder.

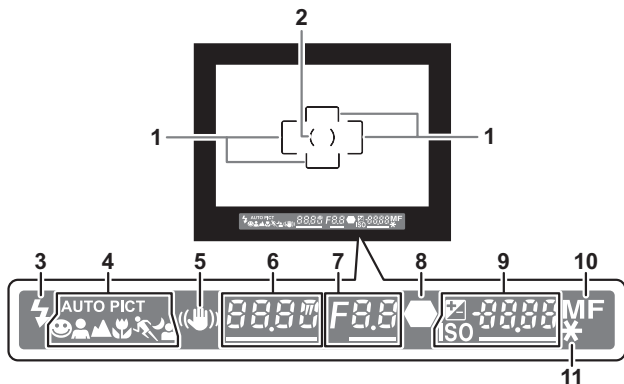

- 1 AF frame (p.48)
- 2 Spot metering frame (p.101)
- 3 Flash status (p.65)
Lit: when flash is available.
Blinks: when flash is recommended but not set.
- 4 Picture mode icon (p.80)
The icon for Picture mode in use appears.
☺ (Normal mode in **AUTO PICT**), 👤 (Portrait), 🏔️ (Landscape), 🌿 (Macro), 🏃 (Moving Object), 🌃 (Night Scene Portrait)
- 5 Shake Reduction (p.121)
Appears when the Shake Reduction function is activated.
- 6 Shutter speed (p.85)
Shutter speed when capturing or adjusting.
Underlined when shutter speed can be adjusted with the e-dial.
- 7 Aperture value (p.85)
Aperture value when capturing or adjusting.
Underlined when aperture value can be adjusted with the e-dial.

- 8** Focus indicator (p.60)
Lit: when the subject is focused.
Blinks: when the subject is not in focus.
- 9** Number of recordable images/EV Compensation/Sensitivity
Displays the number of recordable images with current quality and recorded pixel setting.
The difference from the appropriate exposure value appears if exposure mode is **M**. (p.99)
ISO sensitivity is displayed while the **OK** button is pressed. (p.88).
☑: EV Compensation (p.104)
Underlined when EV Compensation can be adjusted with the e-dial while the **☑Av** button is pressed.
ISO: Sensitivity
Underlined when sensitivity can be adjusted with the e-dial
- 10** Focus mode (p.109)
Appears when set to **MF**.
- 11** AE lock (p.105)
Appears while the AE lock is engaged.



[9999] is the maximum number of recordable images that can be displayed in the viewfinder. Even if the number of recordable images is 10000 or more, [9999] is displayed.

Function settings can be changed using the direct keys, the control panel or the menu. The most frequently used function can be set using the direct keys or the control panel; less common functions can be changed using the menu. Some functions can be changed in more than one way (direct keys and control panel or control panel and menu).

This section explains the basic ways to change function settings.

Using Direct Keys

By pressing the four-way controller (▲▼◀▶) in Capture mode you can set Drive Mode, Flash Mode, White Balance and Sensitivity. (p.76) Following, how to set Flash Mode will be explained as an example.

- 1 Press the four-way controller (▼) in Capture mode.**

The [Flash Mode] screen appears.

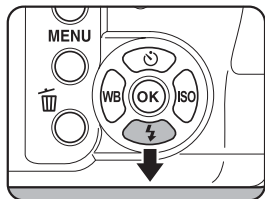

- 2 Use the four-way controller (◀▶) to select a flash mode.**

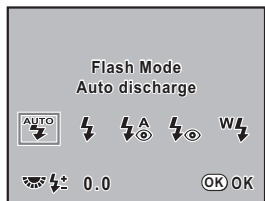

- 3 Press the OK button.**

The camera returns to the status screen and is ready to take a picture.

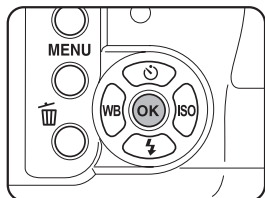

Using the Control Panel

While shooting, the current settings can be checked on the status screen. You can also switch the display to the control panel and change settings. Following, how to set the JPEG Quality will be explained as an example.

1

Before Using Your Camera

1 Check the status screen and then press the OK button.

The control panel appears.

Press the **INFO** button when the status screen is not displayed.

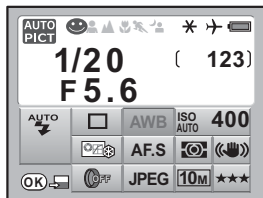

2 Use the four-way controller (▲▼◀▶) to select an item you want to change the setting for.

You cannot select the item that cannot be changed.

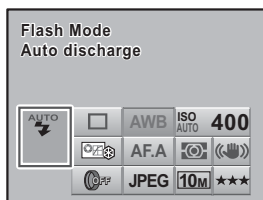

3 Press the OK button.

The setup screen of the selected item appears.

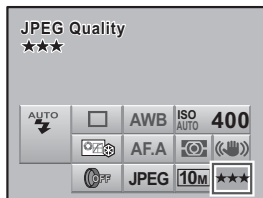

- 4** Use the four-way controller (◀▶) to select a setting value.



- 5** Press the **OK** button.

The camera returns to the status screen and is ready to take a picture.



You can also change settings by turning the e-dial after selecting the setting you want to change according to Step 2 on p.31. For detailed settings such as parameters, press the **OK** button and then make changes.

Using the Menus

This section explains operation methods for [📷 Rec. Mode] menus, [▶ Playback] menus, [⚙️ Set-up] menus and [C Custom Setting] menus. Following, how to set the [Select AF point] in the [📷 Rec. Mode 2] menu will be explained as an example.

- 1** Press the **MENU** button in **Capture mode**.

The [📷 Rec. Mode 1] menu appears on the monitor.

If the **MENU** button is pressed in Playback mode, the [▶ Playback 1] menu appears. When the mode dial is set to **SCN** (Scene), the [SCN Scene] menu appears instead.

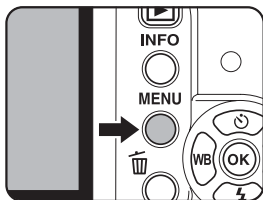

2 Press the four-way controller (▶).

Each time the four-way controller is pressed, the menu will change in the following sequence: [📷 Rec. Mode 2], [📷 Rec. Mode 3], [▶ Playback 1], [▶ Playback 2], [🔍 Set-up 1] ... [C Custom Setting 4].

You can use the e-dial to switch the menus.

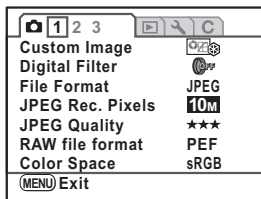

3 Use the four-way controller (▲▼) to choose an item.

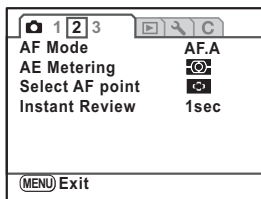

4 Press the four-way controller (▶).

Available settings are displayed.

Press the four-way controller (▶) to move to the pop-up menu if there is one.

5 Use the four-way controller (▲▼) to select a setting.

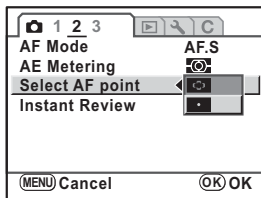

6 Press the OK button.

The camera returns to the menu screen. Next, set other items.

Press the **MENU** button to exit the menu and return to the previously displayed screen.



Even after you press the **MENU** button and close the menu screen, your settings will not be saved if the camera is turned off improperly (such as by removing the battery while the camera is on).

When you are not sure about how to operate a certain function, you can display an explanation of the current operation and status of the camera by pressing the **?** (Help) button.

Help screens can be displayed in the following cases.

- Capture mode
- Playback mode (single-image display, multi-image display, calendar display, folder display or enlarged view)

1 Press the **?** button.

A screen where you can confirm the current status of the camera is displayed.

If you pressed the **?** button in Playback mode, go to Step 3.

2 Press the **?** button again.

The button input screen is displayed.

3 Press the button that you want to see explained.

An explanation of the button appears.

If the **AF** button or the shutter release button is pressed, an explanation does not appear and instead the camera returns to Capture mode.

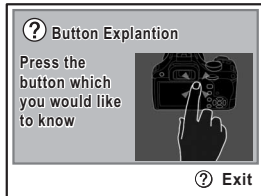

4 Press the **?** button or the **OK** button.

Press the **?** button to exit the help screen. Press the **OK** button to return to the button input screen.

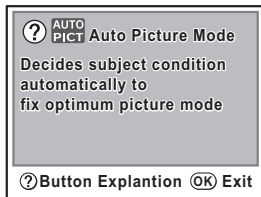

Instead of the Help function, other functions used in Capture mode can also be assigned to the **?** button. This is convenient to easily set other functions after you become familiar with the camera's operation. (p.154)

2 Getting Started

This chapter explains your first steps from purchasing the camera to taking pictures. Be sure to read it and follow the instructions.

Attaching the Strap	36
Inserting the Batteries	37
Inserting/Removing the SD Memory Card	42
Attaching the Lens	46
Adjusting the Viewfinder Diopter	48
Turning the Camera On and Off	49
Initial Settings	50

Attaching the Strap

2

Getting Started

- 1** Pass the end of the strap through the strap lug, then secure it on the inside of the clasp.

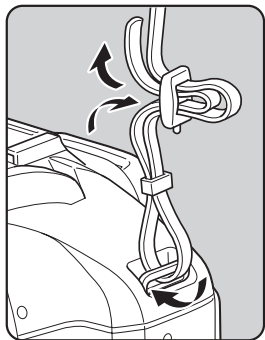

- 2** Pass the other end of the strap through the other strap lug on the camera, then secure it on the inside of the clasp.

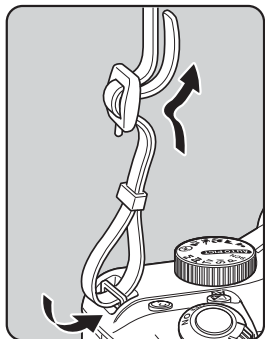

Insert batteries into the camera. Use four AA lithium batteries, AA Ni-MH rechargeable batteries, or AA alkaline batteries.

This camera is packaged with AA lithium batteries for checking the camera functionality but some other kinds of batteries are also compatible. Use the compatible batteries according to the intended purpose.

Available batteries	Characteristics
AA lithium batteries	Provided with the camera. Recommended in cold climates.
AA Ni-MH rechargeable batteries	These are rechargeable and are economical. A commercially available battery charger that is compatible with the batteries is required.
AA alkaline batteries	These are easily obtainable when your usual batteries run out but they may not support all the camera functions under certain conditions. We do not recommend their use except in emergencies and checking the camera functionality.



- The use of Ni-Mn batteries is not recommended as the batteries' voltage characteristics may cause a malfunction.
- AA lithium batteries and AA alkaline batteries that can be used in this camera are not rechargeable.
- Do not open the battery cover or remove the batteries while the power is on.
- Remove the batteries when you will not use the camera for a long while. The batteries may leak.
- If the date and time settings have been reset when you insert new batteries after a long time, follow the procedure for "Setting the Date and Time" (p.54).
- Insert batteries correctly. Batteries inserted incorrectly may cause a camera breakdown. Wipe the electrodes of the batteries before inserting.
- Replace all the batteries at the same time and do not mix battery types, brands or old batteries with new ones. Otherwise, malfunctions, such as the battery level not being displayed properly, may occur.

- 1** Push and hold the battery cover unlock lever as shown in the illustration (①), slide the battery cover toward the lens (②) and then flip open.

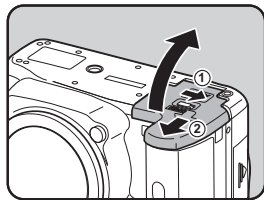

- 2** Insert the batteries according to the +/- indicators in the battery chamber.

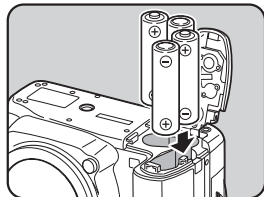

- 3** Press down on the batteries with the battery cover (①) and slide it as shown in the illustration (②) to close.

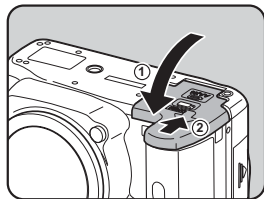

Be sure to fully close the battery cover. The camera will not turn on if the battery cover is open.



- Use the AC adapter kit K-AC84 (optional) when using the camera for a prolonged period. (p.40)
- Check the battery orientation if the camera does not operate properly after replacing the batteries.

Battery Level Indicator

You can confirm remaining battery level by checking the  displayed in the status screen.

 lit : Battery is full.



 lit : Battery is running low.





 lit : Battery is almost empty.



The camera turns off after displaying a message [Battery depleted].



 or  may appear even when the battery level is sufficient if the camera is used at low temperatures or when performing continuous shooting consecutively. Turn the camera off and on again. If  appears, you can use the camera.

Approximate Image Storage Capacity and Playback Time (New Batteries)

Batteries (Temperature)	Normal recording	Flash photography		Playback time
		50% use	100% use	
AA lithium batteries (23°C) (0°C)	1650	1000	800	750 minutes
	1400	850	690	640 minutes
AA rechargeable batteries (NiMH 2700mAh) (23°C) (0°C)	1100	640	500	510 minutes
	750	500	350	430 minutes
AA Alkaline batteries (23°C) (0°C)	360	260	160	350 minutes
	Not applicable	Not applicable	Not applicable	240 minutes

The picture storage capacity (normal recording and flash use 50%) is based on measuring conditions in accordance with CIPA standards, while other data are based on our measuring conditions. Some deviation from the above figures may occur in actual use depending on shooting mode and shooting conditions.



- Battery performance temporarily decreases as the temperature decreases. When using the camera in cold climates, have extra batteries at hand and keep them warm in your pocket. Battery performance will return to normal when returned to room temperature.
- Have extra batteries ready when traveling overseas, taking pictures in cold climates, or when you will be taking a lot of pictures.

Using the AC Adapter (Optional)

We recommend using the AC adapter kit K-AC84 (optional) when using the monitor for a long time or when connecting to your computer.

1 Make sure the camera is turned off.

If batteries were inserted into the camera, open the battery cover and remove the batteries. See Step 1 on p.38.

2 Open the battery cover and pull out the electric cable cover (1) on the right side of the battery chamber.

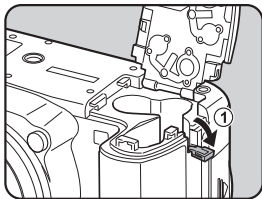

3 Insert the DC coupler into the battery chamber.

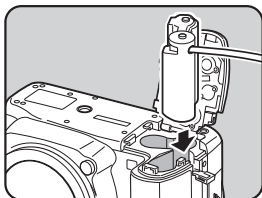

- 4** Pull out the DC coupler's electric cable as shown in the illustration.

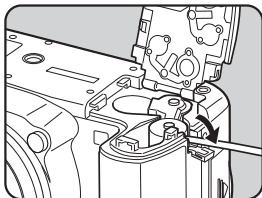

- 5** Close the battery cover.

See Step 3 on p.38.

- 6** Connect the DC terminal on the AC adapter to the DC coupler.

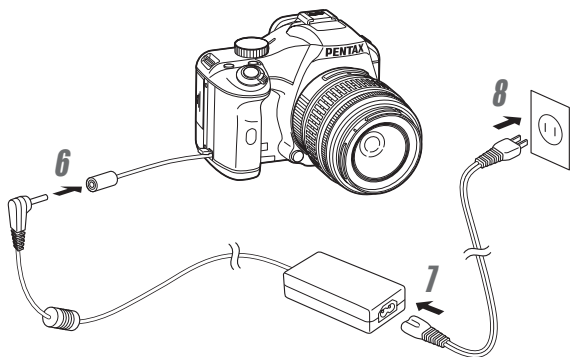

- 7** Connect the AC plug cord to the AC adapter.

- 8** Plug the AC cord into the power outlet.



- Make sure the camera is turned off before connecting or disconnecting the AC adapter.
- Make sure connections are secure between the terminals. SD Memory Card and data will be corrupted if disconnected while the camera is recording or reading data.
- Close the electric cable cover when not using the AC adapter.



Be sure to read the AC adapter kit K-AC84 Operating Manual when using the AC adapter.

Inserting/Removing the SD Memory Card

This camera uses either an SD Memory Card or an SDHC Memory Card. (Both cards are referred to as SD Memory Cards hereafter.) Make sure the camera is turned off before inserting or removing the SD Memory Card (user supplied).

Caution

- Do not remove the SD Memory Card while the card access lamp lights.
- Use this camera to format (initialize) an SD Memory Card that is unused or has been used on other cameras or digital devices. Refer to "Formatting the SD Memory Card" (p.214) for details on formatting.

- 1 Slide the card cover in the direction of the arrow (1) and then lift it to open (2).**

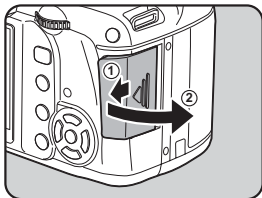

- 2 Insert the card all the way with the SD Memory Card label toward the monitor.**

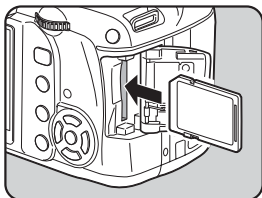

Push the SD Memory Card in once to remove.

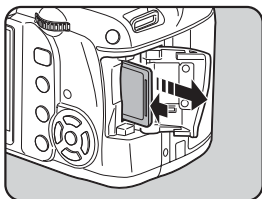

- 3** Close the card cover (①) and then slide it in the direction of the arrow (②).

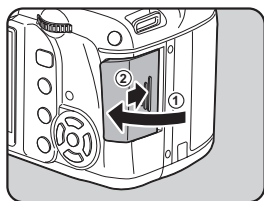

Precautions When Using the SD Memory Card

- The SD Memory Card is equipped with a write-protect switch. Setting the switch to LOCK prevents new data from being recorded on the card, the stored data from being deleted, and the card from being formatted by the camera or computer.
- Care should be taken when removing the SD Memory Card immediately after using the camera because the card may be hot.
- Do not remove the SD Memory Card or turn the camera off while images or sound files are being played back or saved to the card, or the camera is connected to a computer with the USB cable. This may cause the data to be lost or the card to be damaged.
- Do not bend the SD Memory Card or subject it to violent impact. Keep it away from water and store away from high temperatures.
- Do not remove the SD Memory Card during formatting. The card may be damaged beyond use.
- Data on the SD Memory Card may be deleted in the following circumstances. We do not accept any liability for data that is deleted if
 - (1) the SD Memory Card is mishandled by the user.
 - (2) the SD Memory Card is exposed to static electricity or electrical interference.
 - (3) the SD Memory Card has not been used for a long time.
 - (4) the SD Memory Card is ejected or the battery is removed while the data on the card is being recorded or accessed.
- If the SD Memory Card is not used for a long time, the data on the card may become unreadable. Be sure to regularly make a backup of important data on a computer.
- Avoid using or storing the card where it may be exposed to static electricity or electrical interference.

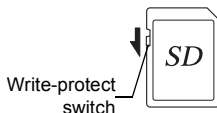

- Avoid using or storing the card in direct sunlight or where it may be exposed to rapid changes in temperature or to condensation.
- For information on compatible SD Memory Cards, visit the PENTAX website.
- Format new SD Memory Cards. Also format SD Memory Cards used with other cameras.
 - ☞ Formatting the SD Memory Card (p.214)
- Please note that formatting the SD Memory Card will not necessarily delete the data so that it cannot be recovered using off the shelf data recovery software. If you are going to discard, give away or sell your SD Memory Card you should ensure that the data on the card is completely deleted or the card itself is destroyed if it contains any personal or sensitive information. There are off the shelf secure data deletion software programs available that will completely delete the data.

In any case the data on your SD Memory Card should be managed at your own risk.

Recorded Pixels and Quality Level

When the File Format is JPEG

Choose the number of pixels (size) and quality level (JPEG data compression rate) of pictures according to how you intend to use the pictures you have taken.

Pictures with larger recorded pixels or more ★s are clearer when printed. The number of pictures that can be taken (the number of pictures that can be recorded on an SD Memory Card) decreases with larger file sizes. The quality of the captured photo or printed picture depends on the quality level, exposure control, resolution of the printer and a variety of other factors so you do not need to select more than the required number of pixels. For example, to print in postcard size, **2M** (1824×1216) is adequate. Set the appropriate recorded size and quality level depending on how the picture will be used.

Choose the appropriate number of recorded pixels and quality level for JPEG images on the control panel.

- ☞ Setting the JPEG Recorded Pixels (p.150)
- ☞ Setting the JPEG Quality Level (p.151)

● JPEG Recorded Pixels, JPEG Quality and Approximate Image Storage Capacity

JPEG Quality		★★★	★★	★
JPEG Rec. Pixels		Best	Better	Good
10M	(3872×2592)	231	343	586
6M	(3008×2000)	387	570	974
2M	(1824×1216)	902	1549	2627

- The above table shows the approximate image storage capacity when using a 1 GB SD Memory Card.
- The above figures may vary depending on the subject, shooting conditions, shooting mode and SD Memory Card, etc.

When the File Format is RAW

With the *K-m/K2000*, you can record in the versatile JPEG format or the high quality and editable RAW format. For RAW file format, you can select the PENTAX original PEF format or general-purpose DNG (Digital Negative) format designed by Adobe Systems. On a 1 GB SD Memory Card, you can record up to 59 images in PEF format or 58 images in DNG format.

☞ Setting the File Format (p.152)

Attaching the Lens

Attach a proper lens to the camera's body.

When you use one of the following lenses with the **K-m/K2000**, all the camera's exposure modes will be available.

- (a) DA, DA L, D FA, FA J lenses
- (b) Lenses with an Aperture **A** (Auto) position, when used in the **A** position



Turn the camera off before attaching or removing the lens to prevent unexpected lens movement.



- When lenses described in (b) are used in a position other than **A**, some functions will be restricted. See "Notes on [19. Using Aperture Ring]" (p.241).
- With factory default settings, the camera will not work with other lenses and accessories. Set [19. Using aperture ring] in the [C Custom Setting 3] menu to [Permitted] to use them. (p.241)

1 Check that the camera is turned off.

2 Remove the body mount cover (①) and lens mount cover (②).

Be sure to put the lens down with the lens mount side facing upward to protect the lens mount from damage after removal.

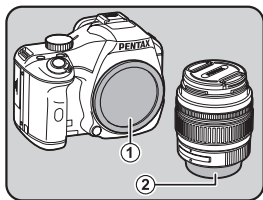

3 Align the Lens mount index (red dot) on the camera and the lens, and secure by turning the lens clockwise until it clicks.

After attaching, turn the lens counterclockwise to check that the lens is locked in place.

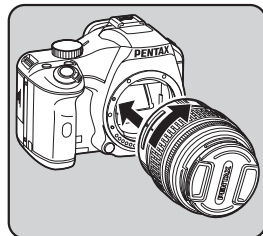

4 Remove the front lens cap by pushing the indicated portions inward.

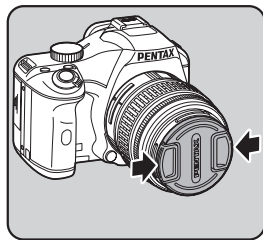

To detach the lens, hold down the lens unlock button (3) and turn the lens counterclockwise.

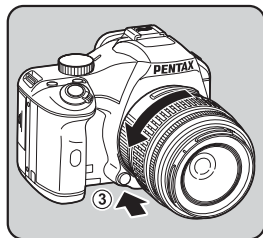

- We assume no responsibility nor liability for accidents, damages and malfunctions resulting from the use of lenses made by other manufacturers.
- The camera body and lens mount incorporate lens information contacts and an AF coupler. Dirt, dust, or corrosion may damage the electrical system. When necessary, clean the contacts with a soft dry cloth.



The body mount cover (1) is a cover to prevent scratches and block dust when shipped. Body Mount Cap K is sold separately and has a lock function.

Adjusting the Viewfinder Diopter

Adjust the viewfinder diopter to suit your eyesight.

If it is difficult to see the viewfinder image clearly, slide the diopter adjustment lever sideways.

You can adjust the diopter from approximately -2.5 to $+1.5$ m⁻¹.

1 Look through the viewfinder and slide the diopter adjustment lever left or right.

Adjust the lever until the AF frame in the viewfinder is focused.

Point the camera at a white wall or other bright and consistent surface.

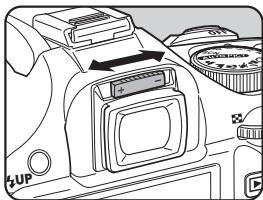

AF frame



- The Eyecup F₀ is attached to the viewfinder portion when the camera leaves the factory. Diopter adjustment is available with the Eyecup F₀ attached. However, adjustment is easier with the eyecup removed.
- To remove the Eyecup F₀, pull it out in the direction of the arrow.
To attach the Eyecup F₀, align it with the groove on the viewfinder eyepiece and push it into position.
- If it is difficult to see the viewfinder image clearly even if you set the diopter adjustment lever, use the optional diopter correction lens adapter M. However, the Eyecup F₀ must be removed to use this adapter. (p.250)

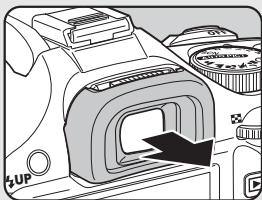



1 Move the main switch to [ON].

The camera will turn on.

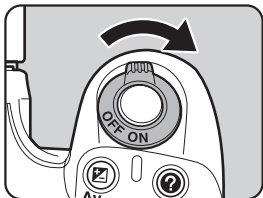
Move the main switch to [OFF] to turn off the camera.



- Always turn the camera off when not in use.
- The power will automatically turn off when you do not perform any operations within a set period of time. To reactivate the camera after the camera turns off automatically, turn it on again or perform any of the following.
 - Press the shutter release button halfway.
 - Press the  button.
 - Press the **INFO** button.
- By default, the camera is set to power off automatically after 1 minute of inactivity. You can change the setting in [Auto Power Off] in the [ Set-up 2] menu. (p.225)

The first time the camera is turned on after purchasing, the [Language/言語] screen appears on the monitor. Follow the procedure below to set the language displayed on the monitor and the current date and time. Once setting is done, these will not need to be set again when turning your camera on.

If the [Date Adjust] screen appears, set the date and time by following the procedure in “Setting the Date and Time” (p.54).

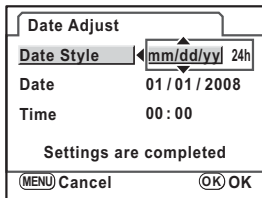

Setting the Display Language

You can choose the language in which the menus, error messages, etc. are displayed from the following: English, French, German, Spanish, Portuguese, Italian, Dutch, Danish, Swedish, Finnish, Polish, Czech, Hungarian, Turkish, Greek, Russian, Korean, Chinese (traditional/simplified) and Japanese.

- 1 Use the four-way controller (▲▼◀▶) to select a desired language.



2 Press the OK button.

The [Initial Setting] screen for the selected language appears.

Press the four-way controller (▼) twice and proceed to Step 10 of p.52 if [Hometown] does not have to be adjusted.

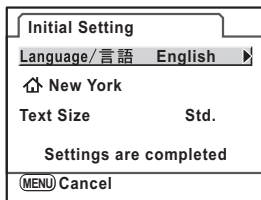

3 Press the four-way controller (▼).

The cursor moves to [New York].

4 Press the four-way controller (▶).

The [New York] screen appears.

5 Use the four-way controller (◀▶) to select a city.

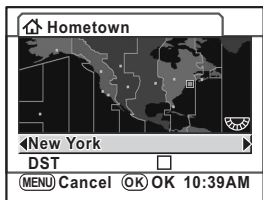

6 Press the four-way controller (▼).

The cursor moves to [DST] (daylight saving time).

7 Use the four-way controller (◀▶) to select (On) or (Off).

8 Press the OK button.

The camera returns to the [Initial Setting] screen.

9 Press the four-way controller (▼).

The cursor moves to [Text Size].

- 10** Press the four-way controller (▶) and use the four-way controller (▲ ▼) to select [Std.] or [Large].

Selecting [Large] magnifies the selected menu item.

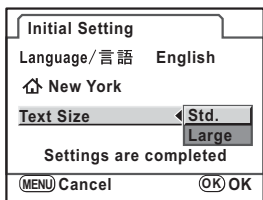

- 11** Press the OK button.

- 12** Use the four-way controller (▼) to select [Settings are completed].



- 13** Press the OK button.

The [Date Adjust] screen appears.



In this manual, the menu screens hereafter are described with [Text Size] set to [Std.].

When an Incorrect Language is Set

When you mistakenly select a language in the [Language/言語] screen and proceed to the [Date Adjust] screen, you can perform the following operations to set the correct language.

If you have proceeded to switch the camera to Capture mode (and the camera is ready to take a picture), perform the following operations from Step 2 to set the correct language.

- 1 Press the MENU button once to display the guides on the monitor.**

The screen shown on the right is an example of the guides displayed. The displayed screen will vary depending on the selected language.

The guides appear on the monitor for 3 seconds.



- 2 Press the MENU button once.**

[1] is displayed in the upper tab.

SCN is displayed when the mode dial is set to SCN.

- 3 Press the four-way controller (▶) five times.**

[1] is displayed in the upper tab.

Press the four-way controller (▶) six times when the mode dial is set to SCN.

- 4 Use the four-way controller (▼) to select [Language/言語].**

- 5 Press the four-way controller (▶).**

The [Language/言語] screen appears.

- 6 Use the four-way controller (▲▼◀▶) to select a desired language and press the OK button.**

The [Set-up 1] menu in the selected language appears.

Refer to the following pages and set the desired city for [Hometown] and the current date and time as necessary.

- To change Hometown: "Setting the World Time" (p.216)
- To change date and time: "Changing the Date and Time and the Display Style" (p.216)



- When [Hometown] and the date and time are not set, the [Initial Setting] screen or [Date Adjust] screen will be displayed when the camera is turned on again.
- If you have not proceeded to the [Date Adjust] screen, you can reselect a language using the four-way controller (▶) in the [Language/言語] screen.

Setting the Date and Time

Set the current date and time and the display style.

1 Press the four-way controller (▶).

The frame moves to [mm/dd/yy].

2 Use the four-way controller (▲▼) to choose the date style.

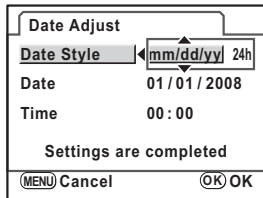

3 Press the four-way controller (▶).

The frame moves to [24h].

4 Use the four-way controller (▲▼) to select 24h (24-hour display) or 12h (12-hour display).

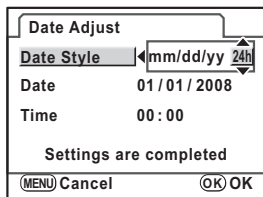

5 Press the four-way controller (▶).

The frame returns to [Date Style].

6 Press the four-way controller (▼).

The frame moves to [Date].

7 Press the four-way controller (▶).

The frame moves to the month.

8 Use the four-way controller (▲▼) to set the month.

Set the day and year in the same manner.

Next, set the time.

If you select [12h] in Step 4, the setting switches between am and pm depending on the time.

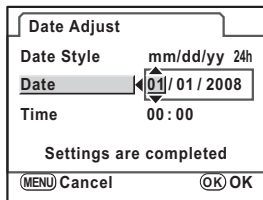

9 Use the four-way controller (▼) to select [Settings are completed].

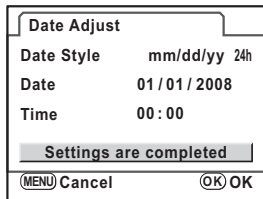

10 Press the OK button.

The camera returns to the status screen and is ready to take a picture.

If you set the date and time with the menu operations, the screen will return to the [↖ Set-up 1] menu. In this case, press the **MENU** button.



Pressing the **MENU** button while adjusting the date cancels the settings made so far and switches the camera to Capture mode. If the power is turned on without the date and time set, the [Date Adjust] screen is displayed if Initial Setting has been completed. You can also set the date later by menu operations. (p.216)



- When you press the **OK** button in Step 10, the camera clock is reset to 00 seconds. To set the exact time, press the **OK** button when the time signal (on the TV, radio, etc.) reaches 00 seconds.
- You can change the language and date and time settings with the menu operations. (p.216, p.219)

Memo

3 Basic Operations

This chapter explains basic operations for shooting by setting mode dial to  (Auto Picture) to ensure successful capturing.

For information about advanced functions and settings for taking pictures, refer to chapter 4 and onward.

Basic Shooting Operation	58
Using a Zoom Lens	64
Using the Built-in Flash	65
Playing Back Pictures	72

Holding the Camera

How you hold the camera is important when taking pictures.

- Hold the camera firmly with both hands.
- Press the shutter release button gently when taking a picture.

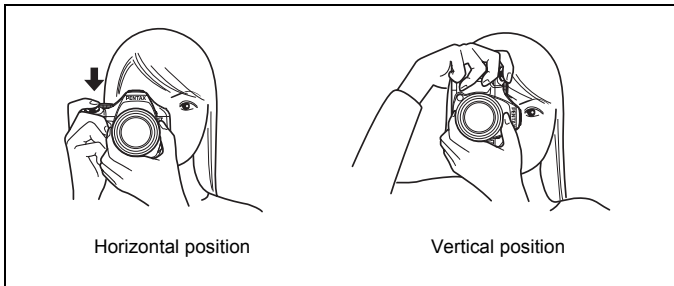

3

Basic Operations



- To reduce camera shake, support your body or the camera on a solid object such as a table, tree, or wall.
- Although there are individual differences among photographers, the shutter speed for a handheld camera is generally $1/(\text{focal length} \times 1.5)$. For example, it is $1/75$ of a second for a focal length of 50 mm and $1/150$ of a second for 100 mm. Use a tripod or the Shake Reduction function (p.121) when using a lower shutter speed.
- When using a telephoto lens, a tripod that is heavier than the total weight of the camera and lens is recommended to avoid camera shake.
- Do not use the Shake Reduction function when using the camera on a tripod. (p.122)

Letting the Camera Choose the Optimal Settings

The *K-m/K2000* features various Capture modes, Focus modes, and Drive modes for expressing your photographic vision. This section explains how to take pictures by simply pressing the shutter release button.

1 Set the mode dial to **AUTO PICT**.

The camera will select the optimal capture mode for the subject.

- ☞ Selecting the Appropriate Capture Mode (p.80)

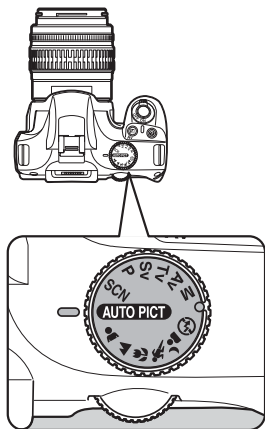

2 Set the focus mode lever to **AF**.

The focus mode changes to **AF** (Autofocus) mode.

When the shutter release button is pressed halfway in **AF**, the lens focuses automatically. (p.109)

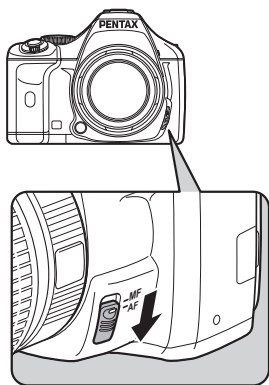

3 Look through the viewfinder to view the subject.

A zoom lens can be used to change the size of the subject in the viewfinder.

☞ Using a Zoom Lens (p.64)

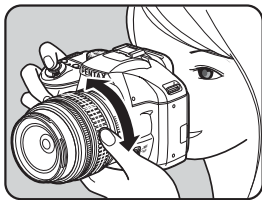

4 Position the subject inside the AF frame and press the shutter release button halfway.

The autofocus system operates. The focus indicator ● appears in the viewfinder when the subject comes into focus.

When set to **AUTO PICT** (Auto Picture) mode, the optimal capture mode is automatically selected from ☺ (Standard)/👤 (Portrait)/▲ (Landscape)/🌸 (Macro)/🏃 (Moving Object)/🌃 (Night Scene Portrait).

The flash pops up automatically when necessary.

- ☞ Operating the shutter release button (p.62)
- ☞ Subjects that are difficult to focus on (p.63)
- ☞ Using the Built-in Flash (p.65)



Flash status

Focus indicator

5 Press the shutter release button fully.

The picture is taken.

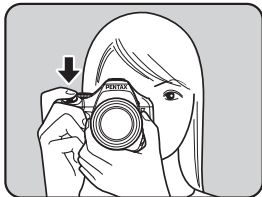

6 Review the captured image on the monitor.

The image appears for 1 second on the monitor shortly after capturing (Instant Review).

- ☛ Setting the Display for Instant Review (p.222)

You can magnify the image during Instant Review with the e-dial. (p.167)

You can delete the image during Instant Review by pressing the  button. (p.73)

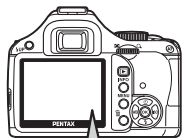

- You can set the camera so that pressing the **AF** button will focus automatically, in the same way as pressing the shutter release button halfway. (p.110)
- You can preview the image on the monitor and check composition, exposure, and focus before taking pictures. (p.119)
- The viewfinder indicators stay on while the shutter release button is pressed halfway. The indications stay on for about 10 seconds (default setting) while the exposure metering timer is on even after taking your finger off the button. (p.28, p.103)

Operating the shutter release button

The shutter release button has two working positions.

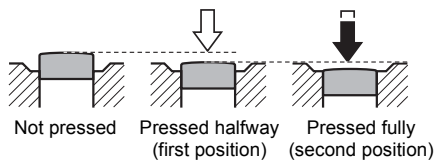

Pressing it down halfway (first position) turns on the viewfinder indicators and the autofocus system operates. Pressing it fully (second position) takes a picture.



- Press the shutter release button gently when taking a picture to prevent camera shake.
- Practice pressing the shutter release button halfway/fully to learn where the first position and second position are.

Subjects that are difficult to focus on

The autofocus mechanism is not perfect. Focusing may be difficult when taking pictures under the following conditions. These also apply to manual focusing using the focus indicator ● in the viewfinder.

- (a) Extremely low-contrast subjects such as a white wall in the focusing area.
- (b) Subjects which do not reflect much light within the focusing area.
- (c) Fast moving objects.
- (d) Strongly reflected light or strong backlighting (bright background).
- (e) If repeating vertical or horizontal line patterns appear within the focusing area.
- (f) Multiple subjects in the foreground and background within the focusing area.

If the subject cannot be focused automatically, set the focus mode lever to **MF** and use the manual focus mode to focus on the subject with the aid of the matte field in the viewfinder. (p.117)



Subject may not be focused even when ● (focus indicator) is displayed when (e) and (f) above apply.

Using a Zoom Lens

Enlarge the subject (telephoto) or capture a wider area (wide angle) with a zoom lens. Adjust the subject to the desired size and take pictures.

1 Turn the zoom ring to the right or left.

Turn the zoom ring clockwise for telephoto and counterclockwise for wide angle.

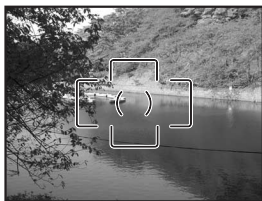
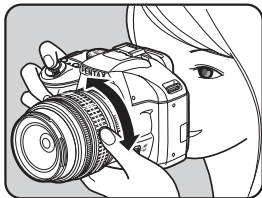

Wide Angle

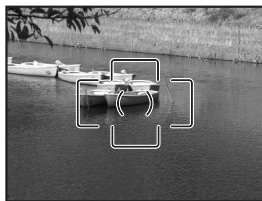

Telephoto



- The smaller the number of the displayed focal length, the wider the angle. The larger the number, the more magnified the image appears.
- Power Zoom functions (Image Size Tracking, Zoom Clip, and Auto Zoom Effect) are not compatible with this camera.

Using the Built-in Flash

Use the following procedures to take pictures in low light or backlit conditions or when you want to manually use the built-in flash. The built-in flash is optimum at about 0.7 m to 5 m from the subject. Exposure will not be properly controlled and vignetting (darkening of the corners of the image due to a lack of light) may occur when used at a distance closer than 0.7 m (this distance varies slightly depending on the lens being used and set sensitivity (p.138)).

Compatibility of built-in flash and lens









Vignetting may occur depending on the lens being used and the capture conditions. We recommend taking a test shot to confirm this.

☞ Lens Compatibility with the Built-in Flash (p.139)



- When using the built-in flash, remove the lens hood before shooting.
- The built-in flash fully discharges for lenses without a function to set aperture lens ring to **A** (Auto).

Setting Flash Mode

Flash Mode	Function
 Auto discharge	Camera automatically determines ambient light and built-in flash pops up. The flash pops up and discharges automatically when necessary, such as when using a shutter speed likely to cause camera shake or in backlit conditions (excluding when in  (Landscape),  (Moving Object) or  (Night Snap) in SCN (Scene) mode). The flash may pop up but may not discharge if the camera determines that the flash is not necessary.
 Flash On	Discharges flash manually. Discharges when the flash is popped up, does not discharge when retracted.
 Auto flash+ Redeye reduct	Lights a red-eye reduction light before automatic flash.
 Flash On+ Red-eye	Discharges flash manually. Lights a red-eye reduction light before discharging the flash.
 Wireless Mode	You can synchronize a dedicated external flash (AF540FGZ or AF360FGZ) without using a sync cord.

1 Press the four-way controller (▼) in Capture mode.

The [Flash Mode] screen appears.

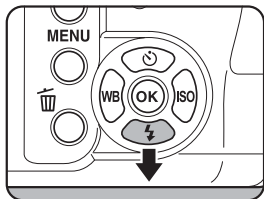

2 Use the four-way controller (◀▶) to select a flash mode.

Turn the e-dial to perform Flash exposure compensation. (p.70)

When the mode dial is set to **P**, **Sv**, **Tv**, **Av** or **M**, **AUTO** and **⚡** appear gray and cannot be selected.

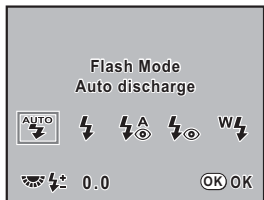





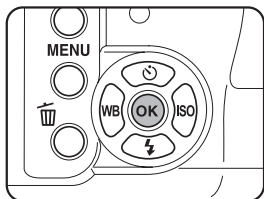

3 Press the OK button.

The camera returns to the status screen and is ready to take a picture.



Using Auto Discharge , (Automatic Flash Popup)

1 Set the mode dial to SCN, , , or .

The flash is deactivated when  (Night Scene),  (Sunset),  (Stage Lighting),  (Candlelight) or  (Museum) is selected in **SCN** (Scene) mode. The flash does not pop up automatically when set to  (Night Snap) in **SCN** (Scene) mode.

2 Press the shutter release button halfway.

The built-in flash pops up if necessary and begins charging. When the flash is fully charged,  appears in the viewfinder. (p.28)

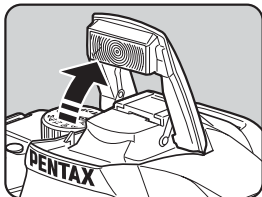

3 Press the shutter release button fully.

The picture is taken.

4 Push down on the portion indicated in the illustration to retract the flash.

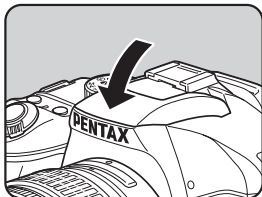

Switch between Auto discharge mode and Flash On mode by pressing the UP button while the built-in flash is popped up.

Using Flash On Mode ⚡, ⚡📷

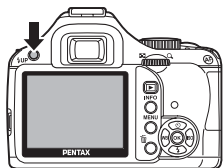
1 Press the **⚡UP** button.

The built-in flash pops up and begins charging. Flash On mode is used regardless of the flash mode settings. When the flash is fully charged, ⚡ appears in the viewfinder. (p.28)

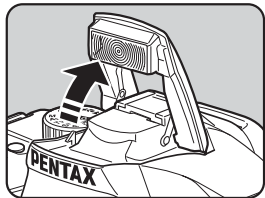
**2** Press the shutter release button fully.

The flash discharges and the picture is taken.

3 Push the flash down to retract.



When the mode dial is set to 📷 (Flash Off), the built-in flash will not pop up even if the **⚡UP** button is pressed.

Using red-eye reduction flash

“Red-eye” is the phenomenon where eyes look reddish in photographs taken in dark environments with a flash. This is caused by the reflection of the electronic flash in the retina of the eye. Red-eye occurs because pupils are dilated in dark environments. This phenomenon cannot be averted but the following measures can be used to combat it.

- Brighten the surroundings when shooting.
- Set to wide angle and move closer to the subject if a zoom lens is in use.
- Use a flash that supports red-eye reduction.
- Position the flash as far away from the camera as possible when using an external flash.

The red-eye reduction function on this camera reduces red-eye by discharging the flash twice. With the red-eye reduction function, the pre-flash is discharged just before the shutter is released. This reduces pupil dilation. The main flash is then discharged while the pupils are smaller, reducing the red-eye effect.

To use the red-eye reduction function in Picture mode or **SCN** (Scene) mode, select  or . Set to  in other modes.

Daylight-Sync Shooting

In daylight conditions, the flash will eliminate shadows when a portrait picture is taken with a person's face cast in shadow. Use of the flash in this way is called Daylight-Sync Shooting. Flash On is used when shooting with Daylight-Sync Shooting.

● Taking pictures

- 1 Pop up the flash manually and confirm that Flash Mode is set to . (p.68)
- 2 Confirm that the flash is fully charged.
- 3 Take a picture.



Without Daylight-Sync



With Daylight-Sync



The picture may be overexposed if the background is too bright.

Compensating Flash Output

You can change the flash output in a range of -2.0 to $+1.0$. The flash compensation values are as follows for $1/2$ EV and $1/3$ EV.

Step interval	Flash compensation
$1/2$ EV	$-2.0, -1.5, -1.0, -0.5, 0.0, +0.5, +1.0$
$1/3$ EV	$-2.0, -1.7, -1.3, -1.0, -0.7, -0.3, 0.0, +0.3, +0.7, +1.0$

Set interval of steps in [1. EV Steps] (p.105) in the [C Custom Setting 1] menu.

Set the flash compensation value by turning the e-dial in the [Flash Mode] screen.

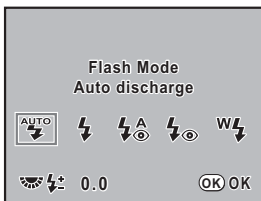

- If the maximum flash output is exceeded when corrected to the plus (+) side, no compensation will be effective.
- Compensating to the minus (–) side may not affect the image if the subject is too close, aperture is low or sensitivity is high.
- The flash compensation is also effective for external flash units which support P-TTL auto flash mode.

Allowing Shooting while Charging the Flash

You can set to enable shooting while the flash is being charged. Set [On] for [14. Release when Charging] in the [C Custom Setting 2] menu (p.78). Pictures cannot be taken while the flash is charging by default.

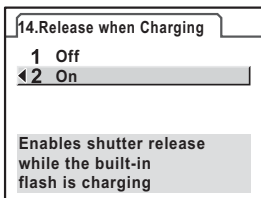

Playing Back Images

You can play back captured pictures with the camera.



Use the included "PENTAX PHOTO Browser 3" software to play back pictures using a computer. Refer to the "PENTAX PHOTO Browser 3/PENTAX PHOTO Laboratory 3 Operating Manual" for details.

3

Basic Operations

1 Press the button after taking a picture.

The most recently captured image (image with the largest file number) is displayed on the monitor.

Press the **INFO** button during playback to switch the information display such as the image data for the displayed image.

Refer to p.24 - p.26 for display information details.

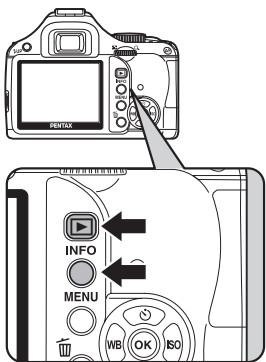

2 Press the four-way controller ().

◀: The previous image appears.

▶: The next image appears.

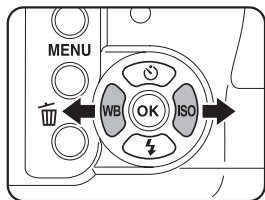

Refer to "Playback Functions" (p.166) for playback function details.

Deleting Images

You can delete one image at a time.



- Deleted images cannot be restored.
- Protected images cannot be deleted.

1 Press the button and use the four-way controller (◀▶) to select an image to delete.

2 Press the button.

The Delete screen appears.

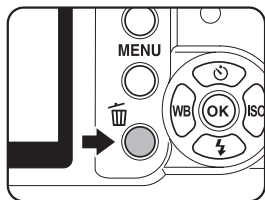

3 Use the four-way controller (▲▼) to select [Delete].

Select a file format to delete for images saved in RAW+ format.

Delete JPEG	Deletes only the JPEG image.
Delete RAW	Deletes only the RAW image.
Delete RAW+JPEG	Deletes both file formats.



4 Press the **OK** button.

The image is deleted.



When deleting multiple images at once, refer to “Deleting Multiple Images” (p.180).

Memo

4 Shooting Functions

This chapter describes the various basic and advanced shooting functions available with the *K-m/K2000*.

How to Operate the Shooting Functions	76
Selecting the Appropriate Capture Mode	80
Setting the Exposure	85
Focusing	109
Checking the Composition, Exposure and Focus Before Shooting (Digital Preview)	119
Using Shake Reduction Function to Prevent Camera Shake	121
Continuous Shooting	130
Taking Pictures Using Digital Filters	132

How to Operate the Shooting Functions

You can change capture-related settings using the direct keys, control panel, [Rec. Mode] menus or [C Custom Setting] menus.



For details on how to operate the menus, see "Using the Menus" (p.32).

Direct Keys Setting Items

Press the four-way controller (▲▼◀▶) in Capture mode to set the following items.

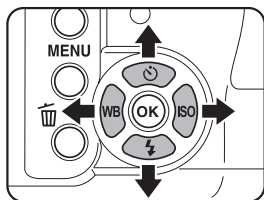







Key or Button	Item	Function	Page
▲	Drive Mode	Selects Continuous shooting, Self-timer, Remote control or Auto Bracket shooting.	p.106 p.125 p.128 p.130
▼	Flash Mode	Adjusts the method of flash discharge.	p.65
◀	White Balance	Adjusts the color balance to match the type of the light source illuminating the subject.	p.159
▶	Sensitivity	Sets the ISO sensitivity.	p.87



Functions that can be accessed with the direct keys can also be changed using the control panel (p.31).

Rec. Mode Menu Setting Items

Perform the following settings in the [ Rec. Mode 1-3] menu. Press the **MENU** button in Capture mode. The [ Rec. Mode 1] menu appears.

Menu	Item	Function	Page
 1	Custom Image*	Sets the image finishing tone such as color and contrast before shooting an image.	p.157
	Digital Filter*	Applies filter effects to take pictures.	p.132
	File Format*	Sets the file format.	p.152
	JPEG Recorded Pixels*	Sets the recording size of images for JPEG shooting.	p.150
	JPEG Quality*	Sets the image quality for JPEG shooting.	p.151
	RAW file format	Sets the file format for RAW shooting.	p.153
	Color Space	Sets the color space to use.	p.164
 2	AF Mode*	Selects the autofocus mode.	p.111
	AE Metering*	Selects the part of the screen to use for measuring brightness and determining exposure.	p.101
	Select AF point	Selects the part of the screen to focus on.	p.113
	Instant Review	Sets whether to display Instant Review, histogram and Bright/Dark area warning.	p.222
 3	Memory	Sets the settings to save when the power is turned off.	p.229
	Help button	Sets the function used when the  (Help) button is pressed.	p.154
	Shake Reduction*	Sets the Shake Reduction function.	p.121
	Input Focal Length	Sets the focal length when using a lens for which focal length information cannot be acquired.	p.124

* Can be set using the control panel.

Custom Setting Menu Setting Items

Set the [C Custom Setting 1-4] menu to fully use the functions of a SLR camera.

Menu	Item	Function	Page
C1	1. EV Steps	Sets the adjustment steps for exposure.	p.105
	2. Sensitivity Steps	Sets the adjustment steps for ISO sensitivity.	p.87
	3. Meter Operating Time	Sets the exposure metering time.	p.103
	4. AE-L with AF locked	Sets whether to lock the exposure value when the focus is locked.	p.115
	5. Link AF Point and AE	Sets whether to link the exposure and AF point in the focusing area during multi-segment metering.	p.103
	6. Auto Bracketing order	Sets the order for Auto bracket shooting.	p.106
	7. Shadow Compensation	Automatically corrects the gradation in the shadow areas.	-
C2	8. Adjust White Balance	Enables fine tuning the white balance.	p.162
	9. AF Button Function	Sets the function assigned to the AF button.	p.105 p.110
	10. AF in remote control	Sets whether to use Autofocus when shooting with remote control. Shutter can be released after AF activates if shutter is released from remote control when set to [On]. Shutter cannot be released until in focus. AF does not activate at shutter release from remote control when set to [Off].	p.129
	11. Slow Shutter Speed NR	Sets whether to use Noise Reduction in slow speed shooting.	p.89
	12. High-ISO Noise Reduction	Sets whether to use Noise Reduction when shooting with a high ISO sensitivity. Select from three levels.	p.89
	13. e-dial in Program	Sets whether to use [Program shift] for the e-dial in P (Program) mode.	p.92
	14. Release when Charging	Sets whether to release shutter while the built-in flash is charging.	p.71

Menu	Item	Function	Page
C3	15. Flash in Wireless Mode	Sets the built-in flash discharge method in Wireless Mode.	p.144
	16. WB when using flash	Sets whether to change the White Balance setting when using flash to [Flash].	p.160
	17. Display Sensitivity	Sets whether to switch the number of recordable images in the viewfinder to the sensitivity display.	–
	18. Catch-in focus	When set to [On], if the AF Mode is set to A.F.A or A.F.S and a manual focus lens is attached, catch-in focus shooting is possible and the shutter is released automatically when the subject comes into focus.	p.118
	19. Using aperture ring	Sets to enable shutter release when lens aperture ring is set at other than the A position.	p.241
	20. Power lamp	Changes the brightness of the power lamp.	p.227
	21. Display status	Sets whether the status screen is always displayed on the monitor.	p.221
C4	Reset Custom function	Resets all the settings in the [C Custom Setting 1-3] menu to the defaults.	p.233

Selecting the Appropriate Capture Mode



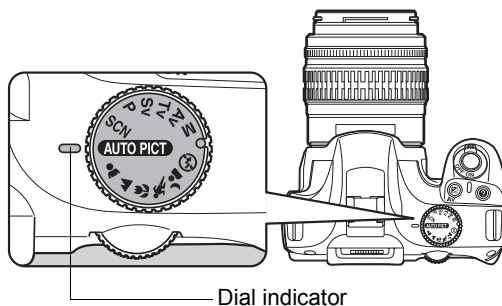



You can switch Capture mode by setting the icons on the mode dial to the dial indicator.











The **K-m/K2000** features various shooting modes, enabling you to take pictures with settings suited for your photographic vision. In this manual, Capture modes are referred to as follows.

Picture mode	AUTO PICT (Auto Picture)/ (Portrait)/ (Landscape)/ (Macro)/ (Moving Object)/ (Night Scene Portrait)/ (Flash Off)
SCN (Scene) mode	(Night Scene)/ (Surf & Snow)/ (Food)/ (Sunset)/ (Stage Lighting)/ (Kids)/ (Pet)/ (Candlelight)/ (Museum)/ (Night Snap)
Exposure mode	P (Program)/ Sv (Sensitivity Priority)/ Tv (Shutter Priority)/ Av (Aperture Priority)/ M (Manual)

Picture Mode

Select  (Portrait),  (Landscape),  (Macro),  (Moving Object),  (Night Scene Portrait) or  (Flash Off) with the mode dial if desired image is not captured in  (Auto Picture) mode.

The characteristics of each mode are as follows.











Mode	Characteristics
 (Auto Picture)	The optimal capture mode is automatically selected from Portrait, Landscape, Macro, Moving Object and Night Scene Portrait modes or standard settings (Normal mode).
 (Portrait)	Optimal for capturing portraits.
 (Landscape)	Deepens the focus range, emphasizes contour and saturation of trees and the sky, and produces a bright image.
 (Macro)	Lets you take vibrant pictures of flowers and other small subjects at short distances.
 (Moving Object)	Lets you take sharp pictures of a quickly moving subject, such as at a sporting event.
 (Night Scene Portrait)	Lets you capture people against a night view or at dusk.
 (Flash Off)	The flash is deactivated. Other settings are the same as the Normal mode in  .



In , even though the flash is used, the camera will use slow shutter speeds so the background areas beyond the flash's reach will also appear correctly exposed in the picture (ESP Slow-Speed Sync (p.136)). To prevent camera shake, either use the Shake Reduction function or mount the camera on a tripod.

SCN Mode

By setting the mode dial to **SCN** (Scene), you can choose from the following 10 shooting scenes.

Mode	Characteristics
 (Night Scene)	Used for night scenes. Use a tripod, etc. to prevent shaking.
 (Surf & Snow)	For capturing images of dazzling backgrounds, such as snowy mountains.
 (Food)	For capturing images of food. Saturation will be rather high to make it look appetizing.
 (Sunset)	For capturing sunrise or sunset in beautiful colors.
 (Stage Lighting)	For capturing moving subjects in poorly lit place.
 (Kids)	For capturing moving kids. Reproduces healthy and bright skin tone.
 (Pet)	For capturing moving pets.
 (Candlelight)	For capturing scenes in candlelight.
 (Museum)	For capturing images in places where a flash is prohibited.
 (Night Snap)	For taking snapshots in poorly lit place.



The flash is deactivated in , , , , and . To prevent camera shake, either use the Shake Reduction function or mount the camera on a tripod.

Selecting a Shooting Scene

1 Set the mode dial to **SCN**.

The Scene mode status screen appears.

2 Press the OK button.

The icon for the currently selected shooting scene appears in the control panel.

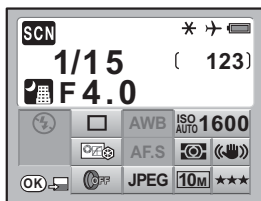

3 Press the OK button.

The Scene mode selection screen appears.



4 Use the four-way controller (▲▼◀▶) or e-dial to choose a Scene mode.

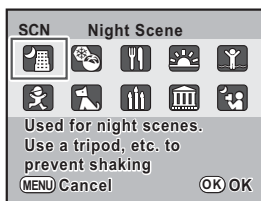

5 Press the OK button.

The camera returns to the status screen and is ready to take a picture.



- When the **MENU** button is pressed while the mode dial is set to **SCN** (Scene), the [SCN Scene] menu appears. The scene can be selected from the [SCN Scene] menu.
- In $\frac{1}{Y}$ or $\frac{1}{Z}$, the number of recorded pixels is fixed at $2M$ and images may take longer to save.

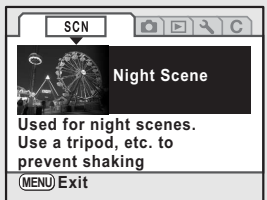

Exposure Mode

Use the exposure modes to change the sensitivity, shutter speed and aperture and take pictures according to your own photographic vision.

Mode	Characteristics	Page
P (Program)	Automatically sets shutter speed and aperture to the proper exposure according to Program line when taking pictures.	p.89
Sv (Sensitivity Priority)	Automatically sets the shutter speed and aperture to the proper exposure according to the set sensitivity.	
Tv (Shutter Priority)	Lets you set the desired shutter speed to freeze or emphasize subject movement. Take pictures of fast moving subjects that look still or subjects that give a sense of movement.	
Av (Aperture Priority)	Lets you set the desired aperture for controlling the depth of field. Use it to obtain a blurred or sharp background.	
M (Manual)	Lets you set shutter speed and aperture to capture the picture with creative intent.	

Effect of Aperture and Shutter Speed

Correct exposure of the subject is determined by the combination of shutter speed and aperture setting. There are many correct combinations of shutter speed and aperture for a particular subject. Different combinations produce different effects.

Effect of Shutter Speed

By changing the shutter speed, you can manipulate how time is expressed in the pictures you create. Unlike with your own naked eyes, in a picture you can capture a fraction of a moment or a whole period of time, creating different effects.

Use the **Tv** (Shutter Priority) mode.

● Using slower shutter speed

If the subject is moving, the image will be blurred because the shutter is open longer. It is possible to enhance the effect of motion (rivers, waterfalls, waves, etc.) by intentionally using a slower shutter speed.

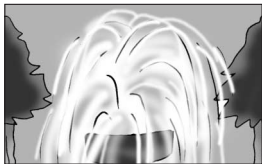

● Using faster shutter speed

Choosing a faster shutter speed will allow freezing the action of a moving subject. A faster shutter speed also helps preventing camera shake.

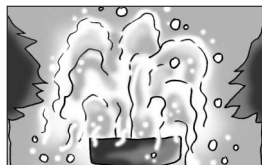

Effect of Aperture

By changing the aperture, you can control the depth of the area that appears in focus in the picture (the depth of field). By either narrowing the focus to emphasize a single point or giving depth to your picture instead you can completely change the feel of the picture you create. Use the **Av** (Aperture Priority) mode.

● Opening the aperture (reduce the aperture value)

Objects closer and farther than the focused subject will be more out of focus. For instance, if you take a picture of a flower against a landscape with the aperture open, the landscape in front and behind the flower will be blurred, emphasizing only the flower.

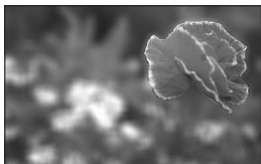

● Closing the aperture (increase the aperture value)

The range in focus expands forward and backward. For instance, if you take a picture of a flower against a landscape with the aperture narrowed, the landscape in front and behind the flower will be in focus.



Aperture and Depth of Field

The following table summarizes how the aperture affects the depth of field.

The depth of field may also change depending on the lens used and the distance to the subject.

Aperture	Open (Smaller value)	↔	Close (Larger value)
Depth of field	Shallow	↔	Deep
Area of focus	Narrow	↔	Wide
Lens focal length	Longer (Telephoto)	↔	Shorter (Wide-angle)
Distance to the subject	Near	↔	Far

- The depth of field for the **K-m/K2000** differs depending on the lens but compared to a 35 mm camera, the value is roughly one aperture setting lower (the focused range becomes narrower).
- The wider the wide-angle lens, and the farther away the subject, the deeper the depth of field is (some zoom lenses do not have a scale for depth of field because of their designs).

Setting the Sensitivity

You can set the sensitivity to suit the brightness of the surroundings. The sensitivity can be set to [AUTO] or within a sensitivity range equivalent to ISO 100 to 3200. The default setting is [AUTO].

1 Press the four-way controller (▶) in Capture mode.

The [Sensitivity] screen appears.

2 Use the four-way controller (▲▼) to select the ISO sensitivity.

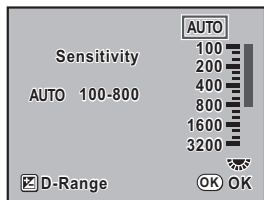

3 Press the OK button.

The camera returns to the status screen and is ready to take a picture.



- [Sensitivity] cannot be used to set the sensitivity when the exposure mode is set to **Sv** (Sensitivity Priority). Turn the e-dial in the status screen to make the setting. (p.92)
- When [Y] (Stage Lighting) or [Night Snap] in **SCN** (Scene) mode is selected, Sensitivity is set to AUTO (200-3200) and Expand Dynamic Range (p.88) is always on.
- Captured images can show more noise if a higher sensitivity is set. You can reduce image noise by setting [12. High-ISO Noise Reduction] in the [C Custom Setting 2] menu. (p.89)
- You can set whether to lock the ISO sensitivity adjustment to increments of 1 EV or to coordinate it with the EV Steps (p.105) in [2. Sensitivity Steps] in the [C Custom Setting 1] menu (p.78).

Setting the Range of Automatic Correction in AUTO

Set range to automatically correct sensitivity when Sensitivity is set to [AUTO]. The sensitivity is automatically corrected in the range of [ISO 100-800] by default.

Turn the e-dial to set the upper sensitivity limit in the [Sensitivity] screen.



When the exposure mode is set to **M** (Manual), the sensitivity cannot be set to [AUTO].

Checking the Sensitivity in Capture Mode

Press the **OK** button in Capture mode. The set sensitivity is displayed in the viewfinder.



You can display the number of recordable images by pressing the **OK** button when the exposure mode is set to **Sv** (Sensitivity Priority).

Expanding the Dynamic Range

Dynamic range is the ratio that indicates the light level expressed by the CCD pixels from bright areas to dark areas. The larger it is, the better the whole range from dark to bright areas will appear in the picture.

By expanding the dynamic range, you can expand the light level expressed by the CCD pixels, making it more difficult for bright area to occur in the image.

Press the **Av** button in the [Sensitivity] screen to turn this function on or off. When turned on, the dynamic range is expanded to 200%. The sensitivity range is reduced to ISO 200 to 3200.

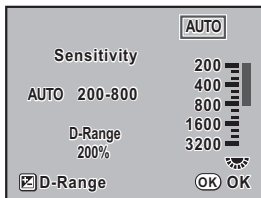

Noise Reduction

When you use a digital camera to shoot with a long exposure or high sensitivity setting, image noise (image roughness or unevenness) becomes noticeable.

You can reduce image noise by using Noise Reduction. Images shot with Noise Reduction take longer to save.

● Slow Shutter Speed NR

Reduces noise during long exposures.

Select from [On] or [Off] for [11. Slow Shutter Speed NR] in the [C Custom Setting 2] menu (p.78).

● High-ISO Noise Reduction

Reduces noise at high sensitivity (ISO) settings.

Select from [Off], [Weakest], [Weak], or [Strong] for [12. High-ISO Noise Reduction] in the [C Custom Setting 2] menu (p.78).

Changing the Exposure Mode

This camera features the following five exposure modes. The settings available for each exposure mode are as follows.

Exposure Mode	Description	EV Compensation	Change Shutter Speed	Change Aperture	Change Sensitivity	Page
P (Program)	Automatically sets shutter speed and aperture to the proper exposure according to Program line when taking pictures.	Yes	#*	#*	Yes	p.90
Sv (Sensitivity Priority)	Automatically sets the shutter speed and aperture to the proper exposure according to the set sensitivity.	Yes	No	No	Other than Auto	p.92

Exposure Mode	Description	EV Compensation	Change Shutter Speed	Change Aperture	Change Sensitivity	Page
Tv (Shutter Priority)	Lets you set the desired shutter speed for expressing moving subjects.	Yes	Yes	No	Yes	p.94
Av (Aperture Priority)	Lets you set aperture for controlling the depth of field.	Yes	No	Yes	Yes	p.96
M (Manual)	Lets you set shutter speed and aperture to capture the picture with creative intent.	No	Yes	Yes	Other than Auto	p.98

* In [13. e-dial in Program] in the [C Custom Setting 2] menu, you can set to change the shutter speed and aperture when the e-dial is turned. (p.92)

Using the P (Program) Mode

Automatically sets shutter speed and aperture to the proper exposure according to Program line when taking pictures.

Use the e-dial to change the shutter speed and aperture while maintaining the proper exposure (p.92).

1 Set the mode dial to P.

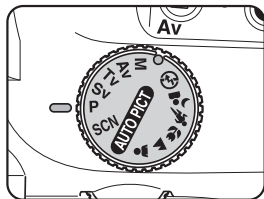

- 2** Turn the e-dial while pressing the  Av button to adjust the exposure.

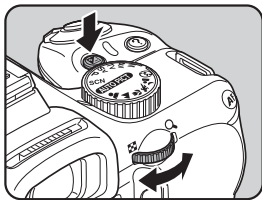

The EV Compensation is displayed in the viewfinder and status screen.

The shutter speed and aperture value are also displayed while adjusting the exposure.

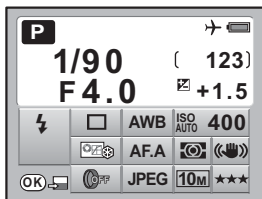

EV Compensation



- Set EV Compensation in increments of 1/2 EV or 1/3 EV. Set in [1. EV Steps] in the [C Custom Setting 1] menu. (p.105)
- You can automatically correct the sensitivity if appropriate exposure cannot be set with the set criteria. Set [Sensitivity] to [AUTO]. (p.87)
- When using a lens with an aperture ring, set the aperture to the **A** position while holding down the auto-lock button on the lens.

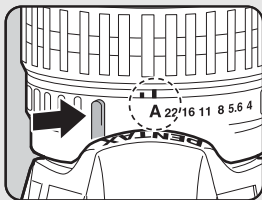

P mode and e-dial

You can set the action for the e-dial when turned in **P** (Program) mode. Set in [13. e-dial in Program] in the [**C** Custom Setting 2] menu (p.78).

1	Off	Disables e-dial operation while Program Automatic Exposure is set.
2	Program shift	Automatically adjusts the aperture value and shutter speed in order to obtain the appropriate exposure.

Using the Sv (Sensitivity Priority) Mode

You can set the sensitivity to suit the brightness of the subject. The shutter speed and aperture are automatically set according to the selected sensitivity to obtain the appropriate exposure.

1 Set the mode dial to Sv.

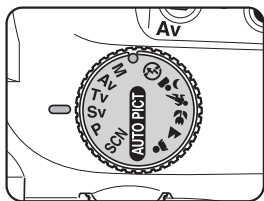

2 Turn the e-dial and adjust the sensitivity.

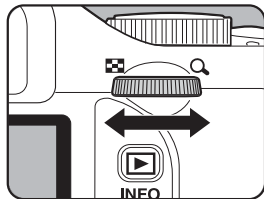

The shutter speed, aperture value and sensitivity are displayed in the viewfinder and status screen.

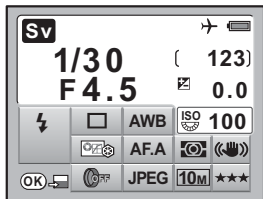

- You can set the sensitivity to values equivalent to ISO 100 to 3200. [AUTO] is not available.
- Turn the e-dial while pressing the  **Av** button to change the EV compensation value. (p.104)
- Set the sensitivity in increments of 1/2 EV or 1/3 EV. Set in [1. EV Steps] in the [C Custom Setting 1] menu. (p.105)
- You cannot set the sensitivity in the [Sensitivity] screen.
- When using a lens with an aperture ring, set the aperture to the **A** position while holding down the auto-lock button on the lens.

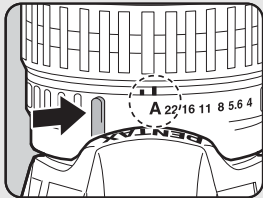

Using the Tv (Shutter Priority) Mode

Lets you set the desired shutter speed for expressing moving subjects. When taking pictures of a fast moving subject, you can increase the shutter speed to make the subject look still or decrease the shutter speed to have the subject show movement.

Aperture value is automatically set to give the appropriate exposure depending on the shutter speed.

☞ Effect of Aperture and Shutter Speed (p.85)

1 Set the mode dial to Tv.

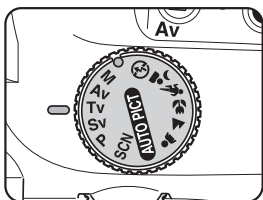

2 Turn the e-dial and adjust the shutter speed.

The shutter speed can be set within the range of 1/4000 to 30 seconds.

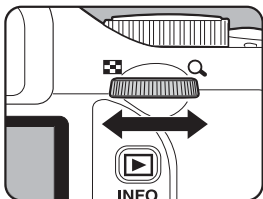

The shutter speed and aperture value are displayed in the viewfinder and status screen.

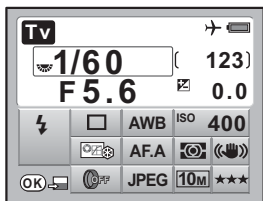



- Turn the e-dial while pressing the **Av** button to change the EV compensation value. (p.104)
- Set the shutter speed in increments of 1/2 EV or 1/3 EV. Set in [1. EV Steps] in the [C Custom Setting 1] menu. (p.105)
- You can automatically correct the sensitivity if appropriate exposure cannot be set with the set criteria. Set [Sensitivity] to [AUTO]. (p.87)
- When using a lens with an aperture ring, set the aperture to the **A** position while holding down the auto-lock button on the lens.

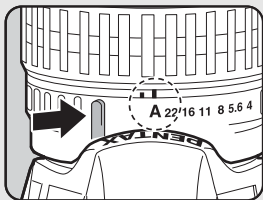

Exposure Warning

If the subject is too bright or too dark, the aperture value will blink in the viewfinder. If the subject is too bright, choose a faster shutter speed. If it is too dark, choose a slower shutter speed. When the aperture value indication stops blinking, you can take a picture with proper exposure. Use an optional ND (Neutral Density) filter if the subject is too bright. Use a flash if it is too dark.



Using the Av (Aperture Priority) Mode

Set aperture for controlling the depth of field. The depth of field is deeper and the front and back of the focused object is clear when aperture is set to a large value. The depth of field is shallower and the front and back of the focused object is blurred when aperture is set to a small value.

Shutter speed is automatically set to appropriate exposure depending on the aperture value.

☞ Effect of Aperture and Shutter Speed (p.85)

1 Set the mode dial to Av.

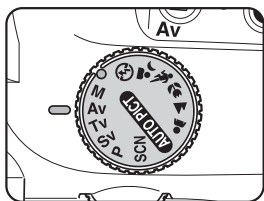

2 Turn the e-dial and adjust the aperture value.

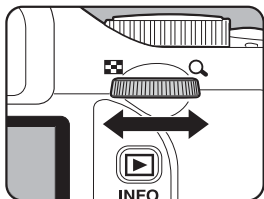

The shutter speed and aperture value are displayed in the viewfinder and status screen.

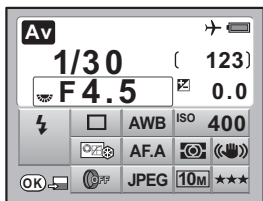



- Turn the e-dial while pressing the **Av** button to change the EV compensation value. (p.104)
- Set the aperture value in increments of 1/2 EV or 1/3 EV. Set in [1. EV Steps] in the [C Custom Setting 1] menu. (p.105)
- You can automatically correct the sensitivity if appropriate exposure cannot be set with the set criteria. Set [Sensitivity] to [AUTO]. (p.87)
- When using a lens with an aperture ring, set the aperture to the **A** position while holding down the auto-lock button on the lens.

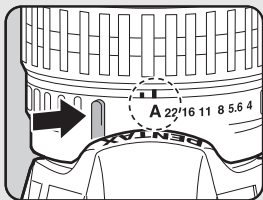

Exposure Warning

If the subject is too bright or too dark, the shutter speed will blink in the viewfinder. When the subject is too bright, set the aperture smaller (larger number), and when too dark, open the aperture further (smaller number). Once blinking stops, you can take a picture with the proper exposure.

Use an optional ND (Neutral Density) filter if the subject is too bright. Use a flash if it is too dark.



Using M (Manual) Mode

You can set the shutter speed and aperture value. This mode is suitable to take pictures of your choice by combining them. This mode is convenient for taking pictures using the same combination of the shutter speed and aperture settings or taking intentionally underexposed (darker) or over-exposed (brighter) photographs.

 Effect of Aperture and Shutter Speed (p.85)

1 Set the mode dial to M.

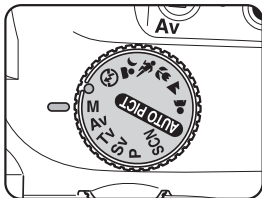

2 Turn the e-dial and adjust the shutter speed.

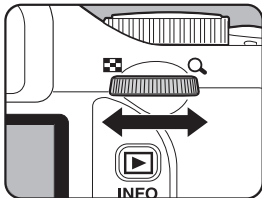

3 Turn the e-dial while pressing the Av button and adjust the aperture.

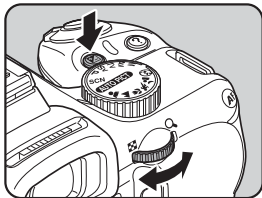

The shutter speed and aperture value are displayed in the viewfinder and status screen.

On the status screen, the e-dial indicator appears next to the shutter speed or aperture value, depending on which is being adjusted.

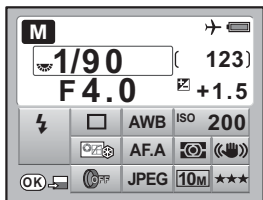

Of the shutter speed and aperture value, the value being adjusted is underlined in the status screen.

While adjusting the shutter speed or aperture value, the difference from the appropriate exposure (EV value) appears in the viewfinder. The appropriate exposure is set when [0.0] is displayed.



Difference from the appropriate exposure



- When the sensitivity is set to [AUTO] and exposure mode is set to **M** (Manual) mode, the sensitivity is set to a value equivalent to ISO 100 if the Dynamic Range is set to [Off] and ISO 200 if set to [On].
- Set the shutter speed and aperture values in increments of 1/2 EV or 1/3 EV. Set in [1. EV Steps] in the [C Custom Setting 1] menu. (p.105)
- When using a lens with an aperture ring, set the aperture to the **A** position while holding down the auto-lock button on the lens.

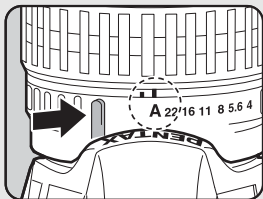

Exposure Warning

While adjusting the shutter speed or aperture value, the difference from the appropriate exposure blinks when it becomes larger than ± 3.0 .



Using AE Lock

If [9. **AF** Button function] in the [**C** Custom Setting 2] menu is set to [AE Lock], you can press the **AF** button to memorize the exposure value. (p.105)

Example: If the shutter speed is 1/125 sec and aperture is F5.6 and is recorded with the **AF** button, and the shutter speed is changed to 1/30 sec with the e-dial, the aperture automatically changes to F11.

Using the Bulb Shooting

This setting is useful for the long exposures required for shooting night scenes and fireworks.

The shutter remains open as long as the shutter release button is kept pressed.

1 Set the mode dial to **M**.

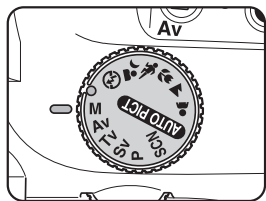

2 Turn the e-dial and set the shutter speed to **Bulb**.

Bulb appears after the slowest shutter speed (30 sec).

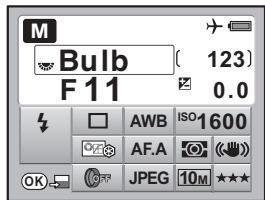

EV Compensation, Continuous shooting and Exposure Bracket are not available in the bulb shooting.



- Turn the e-dial while holding down the **Av** button to adjust the aperture value. (p.104)
- Set the aperture value in increments of 1/2 EV or 1/3 EV. Set in [1. EV Steps] in the [**C** Custom Setting 1] menu. (p.105)
- The Shake Reduction function is automatically turned off during bulb shooting.
- Use a sturdy tripod to prevent camera shake during bulb shooting.
- Bulb shooting is available when using the remote control shooting mode (p.128). The shutter remains open as long as the shutter release button of the optional remote control is held down.
- Noise reduction is a process to reduce noise (image roughness or unevenness) caused by slow shutter speed. Set in [11. Slow Shutter Speed NR] in the [**C** Custom Setting 2] menu. (p.89)
- When the sensitivity is set to [AUTO] and the shutter speed is set to **Bulb**, the sensitivity is set to a value equivalent to ISO 100 if the Dynamic Range is set to [Off] and ISO 200 if set to [On].
- The upper sensitivity limit for the bulb shooting is ISO 1600.

Selecting the Metering Method

Choose the part of the screen to use for measuring brightness and determining exposure. The following three methods can be selected. The default setting is (Multi-segment metering).

	Multi-segment	Segments the viewfinder in 16 parts, meters each portion and determines the appropriate exposure.
	Center-weighted	Measures the entire viewfinder with an emphasis on the center and determines the exposure.
	Spot Metering	Measures only the center of the viewfinder and determines exposure.

1

Press the **OK** button in the status screen.

The control panel appears.

Press the **INFO** button when the status screen is not displayed.

- 2** Use the four-way controller (▲▼◀▶) to select [AE Metering] and press the OK button.

The [AE Metering] screen appears.

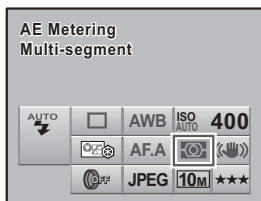

- 3** Use the four-way controller (◀▶) to select a metering method.

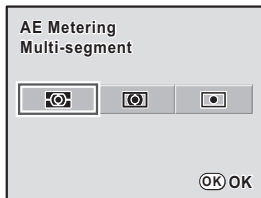

- 4** Press the OK button.

The camera returns to the status screen and is ready to take a picture.

Using the Multi-Segment Metering

The scene in the viewfinder is metered in 16 different zones as shown in the illustration when using the multi-segment metering. Even in backlit locations, this mode automatically determines what level of brightness is in which portion and automatically adjusts exposure.

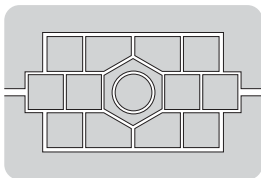

Multi-segment metering method is not available when using a lens other than a DA, DA L, D FA, FA J, FA, F or A lens, or when lens aperture ring is set at other than **A**.

Linking AF Point and AE during Multi-Segment Metering

In [5. Link AF Point and AE] of the [C Custom Setting 1] menu (p.78), you can link the exposure and AF point in the focusing area during multi-segment metering. The default setting is [Off].

1	Off	Exposure is set separately from AF point.
2	On	Exposure is set in accordance with AF point.

Using the Center-Weighted Metering

Metering is weighted at the center of the screen. Use this metering when you want to compensate the exposure by experience, instead of leaving it to the camera. The illustration shows that sensitivity increases as the pattern height increases (center). This mode does not automatically compensate for backlit scenes.

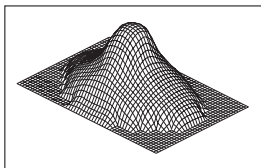

Using the Spot Metering

With spot metering, brightness is measured only within a limited area at the center of the screen as shown in the illustration. You can use this in combination with the AE lock (p.105) when the subject is extremely small and proper exposure is difficult to obtain.

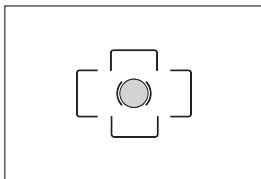

Setting the Meter Operating Time

You can set the exposure metering time to 3 sec, 10 sec or 30 sec in [3. Meter Operating Time] in the [C Custom Setting 1] menu (p.78). The default setting is [10 sec].

Adjusting the Exposure

This allows you to deliberately overexpose (brighten) or under-expose (darken) your picture.

Select 1/2 EV or 1/3 EV in [1. EV Steps] in the [C Custom Setting 1] menu. You can adjust the EV compensation from -2 to +2 (EV).

- 1 **Set the compensation by turning the e-dial while the  Av button is pressed.**

 Av button

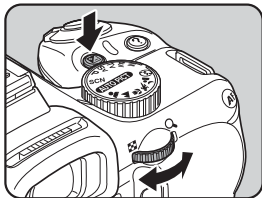

 is displayed in the status screen and viewfinder during compensation.

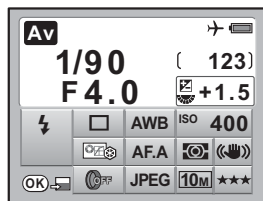

Compensation value



- Exposure compensation is not available when the exposure mode is set to **M** (Manual).
- The EV compensation cannot be canceled by turning the camera off or by setting any other exposure mode.

Changing the Exposure Steps

Set Exposure Steps in [1. EV Steps] in the [C Custom Setting 1] menu (p.78) to increments of 1/2 EV or 1/3 EV.

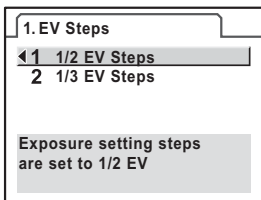

Recording the Exposure Before Shooting (AE Lock)

AE Lock is a function that memorizes the exposure prior to taking a picture. Use this when the subject is too small or backlit and a proper exposure setting cannot be obtained.

- 1** Select [AE Lock] in [9. AF Button function] in the [C Custom Setting 2] menu.

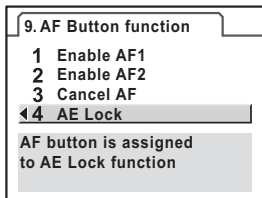

- 2** Press the AF button.

The camera memorizes the exposure (brightness) at that instant.

★ is displayed in the status screen and viewfinder while the AE lock is engaged.

Press it again to unlock.

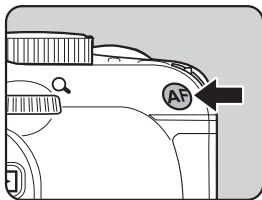



- The exposure remains locked as long as the **AF** button is kept pressed or the shutter release button is kept pressed halfway. The exposure remains in memory for a period between 0.5× to 2× the metering timer even after taking your finger off the **AF** button.
- You will hear a beep when the **AF** button is pressed. The beep can be turned off. (p.215)
- AE lock is not available when the shutter speed is set to **Bulb**.
- The combination of shutter speed and aperture value changes depending on the zooming position even while the AE lock is engaged when using a zoom lens for which the maximum aperture varies depending on the focal length. However, the exposure value does not change and the picture is taken at the brightness level set by the AE lock.
- Exposure can be locked when focus is locked. Set in [4. AE-L with AF locked] in the [C Custom Setting 1] menu. (p.115)

Changing the Exposure Automatically when Shooting (Auto Bracket)

You can take continuous pictures with different exposure when the shutter release button is pressed. The first frame is exposed with no compensation, the second frame is underexposed (negative compensation) and the third is overexposed (positive compensation).



Normal exposure



Underexposure



Overexposure

You can set [6. Auto Bracketing order] in the [C Custom Setting 1] menu (p.78).

Auto Bracketing order

0 → - → +, - → 0 → +, + → 0 → -, 0 → + → -

1

Press the four-way controller (▲) in Capture mode.

The [Drive Mode] screen appears.

- 2 Use the four-way controller (▶) to select  (Auto Bracket).**



- 3 Turn the e-dial to set the EV compensation value.**

The following EV compensation values can be set according to the step interval set in [1. EV Steps] (p.105) in the [C Custom Setting 1] menu.

Step interval	Bracket value
1/2 EV	±0.5, ±1.0, ±1.5, ±2.0
1/3 EV	±0.3, ±0.7, ±1.0, ±1.3, ±1.7, ±2.0

- 4 Press the OK button.**

The camera returns to the status screen and is ready to take a picture.

- 5 Press the shutter release button halfway.**

The focus indicator  and EV compensation value appear in the status screen and viewfinder when focused.

- 6 Press the shutter release button fully.**

Three consecutive images will be taken according to the order set in [6. Auto Bracketing order] in the [C Custom Setting 1] menu.



- When the AF Mode is set to **AFS** (Single mode), the focus is locked in the first frame position and used for subsequent continuous frames.
- When you take your finger off the shutter release button during Auto Bracket, the Auto Bracket exposure setting will remain effective for twice as much time as the exposure metering timer (default setting is 20 seconds) (p.103) and you can take a picture at the next compensation value. In this case, auto focusing works for each frame. After about twice as much time as the exposure metering timer, the camera returns to settings for taking the first picture.
- You can combine Auto Bracket with the built-in flash or external flash (P-TTL auto only) to change only the flash output continuously. However, when using an external flash, holding the shutter release button down to take three continuous frames may cause the second and third frame to be taken before the flash is fully charged. Always take one frame at a time after confirming that charging is complete.
- Exposure Bracket is not available when the shutter speed is set to **Bulb**.

Taking only overexposed or underexposed pictures

You can use Auto Bracket mode for only underexposure or overexposure shots by combining the operation with EV Compensation (p.104). Auto Bracket is performed in both cases on the basis of the specified EV compensation value.

You can focus with the following methods.

AF	Autofocus	The camera automatically focuses on the subject when the shutter release button is pressed halfway.
MF	Manual focus	Manually adjust the focus.

Using the Autofocus

You can also choose the autofocus mode from **A.F.S** (Single mode) where the shutter release button is pressed halfway to focus on the subject and the focus is locked at that position, and **A.F.C** (Continuous mode) where the subject is kept in focus by continuous adjustment while the shutter release button is pressed halfway. The **A.F.A** (Auto) option automatically switches between **A.F.S** and **A.F.C**. The default setting is **A.F.A**.

 Setting the AF Mode (p.111)

1 Set the focus mode lever to **AF**.

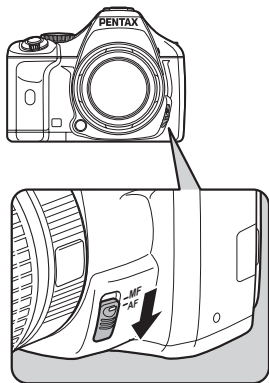

- 2** Look through the viewfinder and press the shutter release button halfway.



The focus indicator  appears and you will hear a beep when the subject comes into focus. (When blinking, the subject is not in focus.)

-  Subjects that are difficult to focus on (p.63)

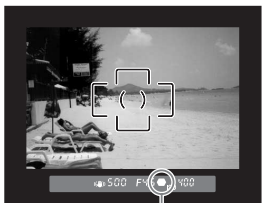

Focus Indicator

Using the AF Button to Focus on the Subject

You can set the camera so that the focusing is performed when the **AF** button is pressed. Use this setting when autofocus by pressing the shutter release button halfway is not desired.

- 1** Select **[Enable AF1]** or **[Enable AF2]** in **[9. AF Button function]** in the **[C Custom Setting 2]** menu.

Enable AF1: Auto focusing is performed using the **AF** button or the shutter release button.

Enable AF2: Auto focusing is performed only when the **AF** button is pressed and not when the shutter release button is pressed halfway.

9. AF Button function

- 1** Enable AF1
- 2 Enable AF2
- 3 Cancel AF
- 4 AE Lock

AF is performed when the button is pressed

2 Press the AF button.

Auto focusing is performed.

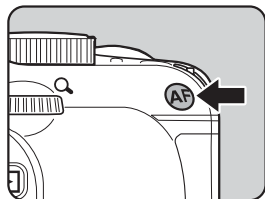

When [Cancel AF] is set, **MF** appears in the viewfinder while the **AF** button is pressed. Autofocus does not activate when the shutter release button is pressed (take your finger off the **AF** button to immediately return to normal AF mode).

Setting the AF Mode

You can choose from the following three autofocus modes. The default setting is **AF.A** (Auto).

AF.A	Auto	Switches automatically between AF.S and AF.C mode according to the subject.
AF.S	Single mode	When the shutter release button is pressed halfway to focus on the subject, the focus is locked at that position.
AF.C	Continuous mode	The subject is kept in focus by continuous adjustment while the shutter release button is pressed halfway. Even if the subject is not in focus, the shutter can be released when the shutter release button is pressed fully.

1 Set the focus mode lever to AF.

2 Press the OK button in the status screen.

The control panel appears.

Press the **INFO** button when the status screen is not displayed.

- 3 Use the four-way controller (▲▼◀▶) to select [AF Mode] and press the OK button.**

The [AF Mode] screen appears.

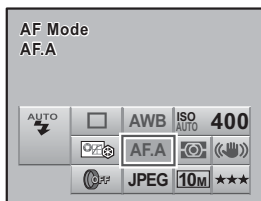

- 4 Use the four-way controller (◀▶) to select an autofocus mode.**

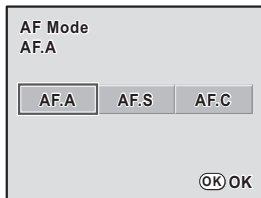

- 5 Press the OK button.**



The camera returns to the status screen and is ready to take a picture.



- AF Mode cannot be changed in Picture mode and **SCN** (Scene) modes.
- **AF.C** can be set when the mode dial is set to **P**, **Sv**, **Tv**, **Av** or **M**. The autofocus mode is set to **AF.C** in (Moving Object) of Picture mode or (Stage Lighting), (Kids), (Pet) or (Night Snap) of **SCN** (Scene) mode.
- In **AF.C**, the focus is adjusted continuously, tracking the moving object as long as the shutter release button is kept pressed halfway.
- In **AF.S**, the focus is locked (focus lock) while the focus indicator is displayed in the viewfinder. To focus on another subject, take your finger off the shutter release button first.
- The shutter cannot be released until the subject is in focus in **AF.S**. If the subject is too close to the camera, move back and take a picture. Adjust the focus manually if the subject is difficult to focus (p.63). (p.116)
- In **AF.S**, press the shutter release button halfway. The built-in flash will discharge automatically several times, making it easier to focus on the subject if the subject is in a dark area and the built-in flash is available.
- When the shutter release button is pressed halfway or the **AF** button is used to adjust the focus in **AF.A** or **AF.C**, the camera automatically tracks the subject if it is determined to be a moving object.
- Always set the camera to **AF.S** when using the Quick-Shift Focus System on a DA lens.

Selecting the Focusing Area (AF Point)

Choose the part of the viewfinder to set focus to. The default setting is  (Wide).

	Wide	The camera automatically selects the optimum AF point.
	Spot	Sets the focusing area to the center of the viewfinder.

Set in [Select AF point] in the [ Rec. Mode 2] menu (p.77).

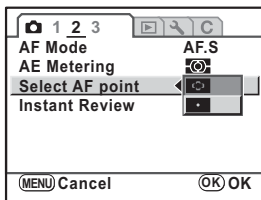

The AF point is fixed to the  (Spot) regardless of this setting with lenses other than DA, DA L, D FA, FA J, FA or F lenses.

Fixing the Focus (Focus Lock)

If the subject is outside the range of the focusing area, the camera cannot automatically focus on the subject. In this situation, set [AF Mode] to **AF.S** (Single mode). You can aim the focusing area toward the subject, use the focus lock and recompose the picture.

- 1** Frame the desired composition for your picture in the viewfinder.

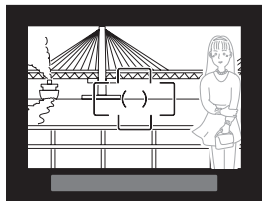

(Example) The person is out of focus and the background is focused instead.

- 2** Center the subject to focus in the viewfinder and press the shutter release button halfway.

The focus indicator  appears and you will hear a beep when the subject comes into focus. (When blinking, the subject is not in focus.)

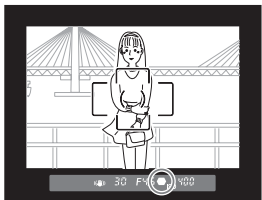

- 3** Lock the focus.

Keep the shutter release button pressed halfway. The focus will remain locked.

4 Re-compose the picture while keeping the shutter release button pressed halfway.

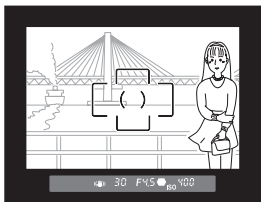

- The focus is locked while the focus indicator ● is displayed.
- Turning the zoom ring in focus lock mode may cause the subject to be out of focus.
- The beep that sounds when the image is focused can be turned off. (p.215)
- You cannot set focus lock when [AF Mode] is set to **AFC** (Continuous mode), the Picture mode is set to **M** (Moving Object) or **SCN** (Scene) mode is set to **L** (Stage Lighting), **K** (Kids), **P** (Pet) or **S** (Night Snap). In such cases, the autofocus continues to focus on the subject until the shutter is released (Continuous Autofocus).

Locking Exposure when the Focus is Locked

Set [4. AE-L with AF locked] in the [C Custom Setting 1] menu (p.78) to lock the exposure value while the focus is locked. Exposure is not locked by default during focus lock.

1	Off	Exposure is not locked when the focus is locked.
2	On	Exposure is locked when the focus is locked.

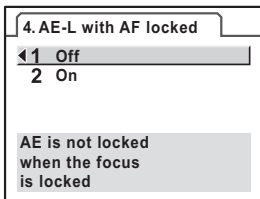

Adjusting the Focus Manually (Manual Focus)

When you adjust the focus manually, you can either check with the focus indicator in the viewfinder or use the viewfinder matte field to adjust focus.

Using the Focus Indicator

The focus indicator  appears in the viewfinder when the subject is in focus even during manual focus.

You can manually adjust the focus using the focus indicator .

- 1 Set the focus mode lever to **MF**.

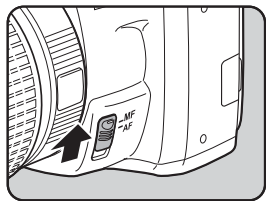

- 2 Look through the viewfinder, press the shutter release button halfway and turn the focusing ring.

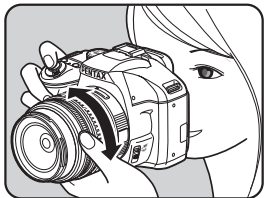

The focus indicator  appears and you will hear a beep when the subject comes into focus.

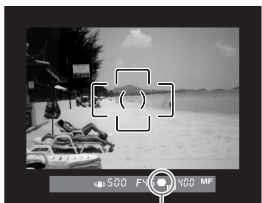

Focus Indicator



- Focus manually using the matte field in the viewfinder when the subject is difficult to focus (p.63) and the focus indicator will not appear.
- The beep that sounds when the image is focused can be turned off. (p.215)

Using the Viewfinder Matte Field

You can manually adjust the focus using the matte field in viewfinder.

- 1** Set the focus mode lever to **MF**.

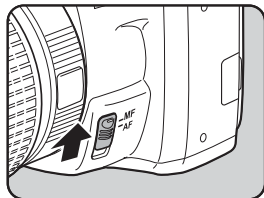

- 2** Look through the viewfinder and turn the focusing ring until the subject looks sharp on the focusing screen.

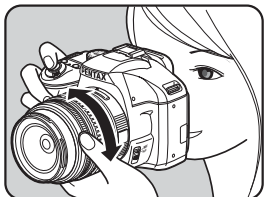

Shooting in Catch-in Focus Mode

When [18. Catch-in focus] in the [C Custom Setting 3] menu (p.79) is set to On, if AF Mode is set to **AF.A** or **AF.S** and one of the following types of lenses is attached, catch-in focus shooting is possible and the shutter is released automatically when the subject comes into focus.

- Manual focus lens
- DA or FA lens that has a **AF** and **MF** setting on the lens (the setting on the lens must be set to **MF** before shooting)

● How to Take Pictures

- 1 Attach a proper lens to the camera.
- 2 Set the focus mode lever to **AF**.
- 3 Set AF Mode to **AF.A** or **AF.S**.
- 4 Set focus on a position the subject will pass.
- 5 Press the shutter release button fully.
The shutter is released automatically when the subject comes into focus in the set position.

Checking the Composition, Exposure and Focus Before Shooting (Digital Preview)

You can use the preview function to check depth of field, composition, exposure and focus before taking a picture.

First, assign the Digital Preview function to the  (Help) button.

- 1** Select [Help button] in the [ Rec. Mode 3] menu and press the four-way controller (▶).

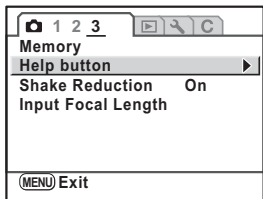

- 2** Press the four-way controller (▶).

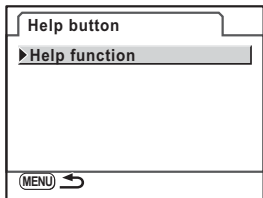

- 3** Use the four-way controller (▲▼) to select [Digital Preview] and press the OK button.

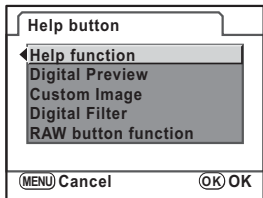

- 4** Use the four-way controller (▲▼) to select [Histogram].

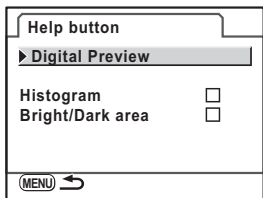

5 Use the four-way controller (◀▶) to select (On) or (Off).

6 Use the four-way controller (▲▼) to select [Bright/Dark area].

7 Use the four-way controller (◀▶) to select (On) or (Off).

8 Press the **MENU** button twice.

The Digital Preview function is assigned to the  button.

The camera returns to the status screen and is ready to take a picture.

9 Focus on the subject, then compose the picture in the viewfinder and press the  button.

The icon  appears in the monitor during preview and you can check the composition, exposure and focus.

Press the shutter release button halfway to end Digital Preview and start focusing.

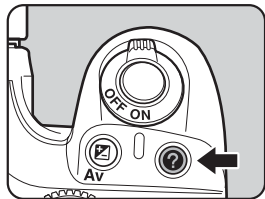

- The maximum display time for Digital Preview is 60 seconds.
- You can magnify the image during Digital Preview with the e-dial. (p.167)

Taking Pictures Using the Shake Reduction Function

You can easily take sharp pictures using the Shake Reduction function.

Shake Reduction

The Shake Reduction function reduces camera shake that occurs when the shutter release button is pressed. This is useful for taking pictures in situations where camera shake is likely to occur. The Shake Reduction function allows you to take pictures at approximately 4 steps slower shutter speed without the risk of camera shake.

The Shake Reduction function is ideal when taking pictures in the following situations.

- When taking pictures in dimly lit locations, such as indoors, at night, on cloudy days and in the shade
- When taking telephoto pictures

Blurred picture



Picture taken with the Shake Reduction function



- The Shake Reduction function does not compensate for blurring caused by subject movement. To take pictures of a moving subject, increase the shutter speed.
- The Shake Reduction function may not fully reduce camera shake when taking close-up shots. In this case, it is recommended that the Shake Reduction function be turned off and the camera be used with a tripod.
- The Shake Reduction function will not fully work when shooting with a very slow shutter speed, for example when shooting a moving subject or night scenes. In this case, it is recommended that the Shake Reduction function be turned off and the camera be used with a tripod.

Shake Reduction Function and Lens Focal Length

The Shake Reduction function operates by acquiring the lens information such as focal length.

If the camera uses a DA, DA L, D FA, FA J, FA or F lens, the lens information is automatically acquired when the Shake Reduction function is activated.

If another type of lens is used, the lens information cannot be automatically acquired even when the Shake Reduction function is activated. In this case, the [Input Focal Length] setting menu appears. Set [Focal Length] manually on the menu.

☞ Setting the Focal Length (p.124)

Turning On the Shake Reduction Function

1 Press the OK button in the status screen.

The control panel appears.

Press the **INFO** button when the status screen is not displayed.

2 Use the four-way controller (▲▼◀▶) to select [Shake Reduction] and press the OK button.

The [Shake Reduction] screen appears.

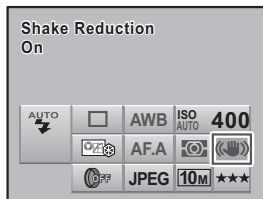

3 Use the four-way controller (◀▶) to select [On].

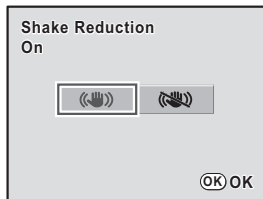

4 Press the OK button.

The camera returns to the status screen and is ready to take a picture.

5 Aim the camera at the subject and press the shutter release button halfway.

 appears in the viewfinder and the Shake Reduction function turns on.

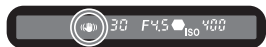

- Be sure to turn the Shake Reduction function off when using the camera with a tripod.
- The Shake Reduction function automatically turns off in the following situations.
 - Self-timer
 - Remote control shooting
 - Bulb shooting
 - Wireless mode with an external flash



- If a type of lens that does not support automatic acquisition of lens information such as focal length is used (p.122), the [Input Focal Length] menu appears. Set the focal length manually in the [Input Focal Length] setting menu.
- Turn the Shake Reduction function off if you will not use the Shake Reduction function.
- The Shake Reduction function will not fully work (for about 2 seconds) right after turning on the camera or restoring from Auto Power Off. Wait for the Shake Reduction function to become stable before gently pressing the shutter release button to take a picture. Press the shutter release button halfway. The camera is ready to take a picture when  appears in the viewfinder.
- Shake Reduction is available with any *K-m/K2000* compatible PENTAX lens. However, when the aperture ring is set at other than the **A** (Auto) position or a lens without an **A** position is used, the camera does not operate unless [19. Using aperture ring] is set to [Permitted] in the [C Custom Setting 3] menu. Set this beforehand. However, in such cases some functions are restricted. Refer to "Notes on [19. Using Aperture Ring]" (p.241) for details.

Setting the Focal Length

The [Input Focal Length] setting menu appears when the camera is turned on with the Shake Reduction function on and a type of lens that does not support automatic acquisition of lens information such as focal length (p.122) is mounted.

Set the focal length manually in the [Input Focal Length] setting menu.



- The [Input Focal Length] setting menu does not appear when using a lens that supports automatic acquisition of lens information such as focal length.
- When using a lens without the **A** position on the aperture or with the aperture set to a position other than the **A** position, set [19. Using aperture ring] on the [**C** Custom Setting 3] menu to [Permitted]. (p.241)

4

1 Use the four-way controller (◀▶) or the e-dial to set [Focal Length].

Select from the following 34 focal length values. (The default setting is [35].)

8	10	12	15	18	20	24	28	30	35
40	45	50	55	65	70	75	85	100	120
135	150	180	200	250	300	350	400	450	500
550	600	700	800						

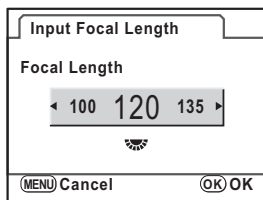

- If the focal length for your lens is not listed above, select the value closest to the actual focal length (example: [18] for 17 mm and [100] for 105 mm).
- When using a zoom lens, select the actual focal length at the zoom setting in the same manner.
- Effect of Shake Reduction is influenced by the shooting distance as well as focal length information. The Shake Reduction function may not be as effective as expected when shooting at close ranges.

2 Press the OK button.



The camera returns to the status screen and is ready to take a picture.



To change the Focal Length setting, use [Input Focal Length] in the [**Rec.** Mode 3] menu (p.77).

Shooting with the Self-Timer

This camera has two types of self-timers:  and .

	Shutter will be released after about 12 seconds. Use this mode to include the photographer in the picture.
	A mirror pops up immediately after shutter release button is pressed. Shutter is released after about 2 seconds. Use this mode to avoid camera shake when the shutter release button is pressed.

1 Mount the camera onto a tripod.

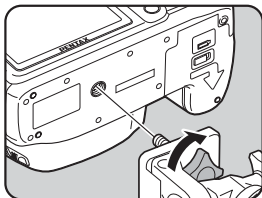

2 Press the four-way controller (▲) in Capture mode.

The [Drive Mode] screen appears.

3 Use the four-way controller (◀▶) to select .



4 Press the four-way controller (▼) and use the four-way controller (◀▶) to select or .



5 Press the OK button.

The camera returns to the status screen and is ready to take a picture.

6 Confirm in the viewfinder that the subject you want to shoot is properly framed and press the shutter release button halfway.

The focus indicator  appears in the viewfinder when the subject is in focus.



7 Press the shutter release button fully.





For , the front self-timer lamp starts blinking slowly and blinks rapidly 2 seconds before the shutter is released.

The beep is heard and the rate increases.

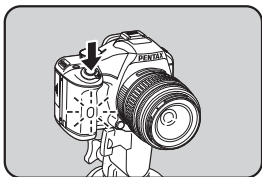
The shutter will be released about 12 seconds after the shutter release button is pressed fully.

For , the shutter will be released about 2 seconds after the shutter release button is pressed fully.



- You can set the camera so that the beep does not sound. (p.215)
- Exposure may be affected if light enters the viewfinder. Use the AE lock function (p.105). The light entering the viewfinder has no effect on the exposure when the exposure mode is set to **M** (Manual) (p.98).
- Select a setting other than  or  in the [Drive Mode] screen to cancel self-timer shooting. The setting is canceled when the camera is turned off if [Drive Mode] in [Memory] (p.229) of [Rec. Mode 3] menu is set to (Off).
- The Shake Reduction function is automatically turned off when  or  is set.

Using the Mirror Up Function

Use the Mirror Up function if camera shake is evident even when remote control unit (optional) is used with a tripod.

When shooting with the 2 sec. Self-Timer, the mirror pops up and the shutter is released 2 seconds after you press it, thereby avoiding the vibration of the mirror.

Follow the procedure below to take a picture with the Mirror Up function.

1 **Mount the camera onto a tripod.**

2 **Select  in the Drive Mode.**

Refer to Steps 1 to 5 on p.125 for details.



3 **Press the shutter release button halfway.**



The autofocus system operates. The focus indicator  appears in the viewfinder when focused.

4 **Press the shutter release button fully.**

The mirror pops up and a picture is taken 2 seconds later. AE lock is enabled with the exposure value set immediately before the mirror pops up.

Shooting with the Remote Control (Optional)

The shutter can be released from a distance by using the optional remote control unit. You can select  (immediate shutter release) or  (3 sec. delayed release) for remote control shooting.

	The shutter will be released immediately after the shutter release button on the remote control unit is pressed.
	When the shutter release button on the remote control unit is pressed, the shutter is released after about 3 seconds.

1 Mount the camera onto a tripod.

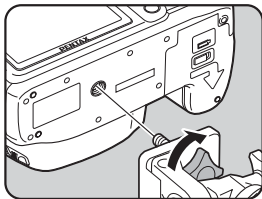

2 Press the four-way controller (▲) in Capture mode.

The [Drive Mode] screen appears.

3 Use the four-way controller (◀▶) to select .

4 Press the four-way controller (▼) and use the four-way controller (◀▶) to select or .

The self-timer lamp will blink to let you know that the camera is in remote control wait status.



5 Press the OK button.

The camera returns to the status screen and is ready to take a picture.

6 Press the shutter release button halfway.

The autofocus system operates. The focus indicator  appears in the viewfinder when focused.

7 Point the remote control unit towards the remote control receiver on the front of the camera and press the shutter release button on the remote control.

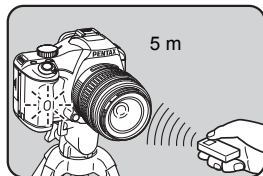





The operating distance of the remote control unit is about 5 m from the front of the camera.

For , the shutter will be released immediately after the shutter release button is pressed.



For _{ss}, the shutter will be released in three seconds after the shutter release button is pressed.





After the picture is taken, the self-timer lamp lights for 2 seconds and then returns to blinking.





- You cannot focus with the remote control unit in default settings. Focus on the subject first with the camera before operating with the remote control. Or you can set [10. AF in remote control] to [On] in the [C Custom Setting 2] menu (p.78).
- When using the remote control unit, flash does not pop up automatically even when set to  (Auto discharge). Pop up the flash manually beforehand. (p.68)
- Exposure may be affected if the light enters the viewfinder. Use the AE lock function (p.105). The light entering the viewfinder has no effect on the exposure when the exposure mode is set to **M** (Manual) (p.98).
- Select a setting other than  or _{ss} in the [Drive Mode] screen to stop the remote control operation after it has been activated. The setting is canceled when the camera is turned off if [Drive Mode] in [Memory] (p.229) of [Rec. Mode 3] menu is set to (Off).
- The Shake Reduction function is automatically turned off when  or _{ss} is set.
- The remote control may not operate in backlit conditions.
- The remote control unit battery can send a remote control signal about 30,000 times. Contact PENTAX Service Center to replace the battery (this will involve a fee).

Pictures can be taken continuously while the shutter release button is held down.

Two types of Continuous shooting are available. With  (Continuous shooting (Hi)), pictures are taken continuously at the fastest frame rate until the camera buffer memory becomes full. With  (Continuous shooting (Lo)), pictures are taken continuously at a given interval.

 Continuous shooting (Hi)	When JPEG quality is set to  (Quality Level ★★★), up to 5 frames are taken continuously at approximately 3.5 fps. The shooting interval will increase as the camera buffer memory fills up.
 Continuous shooting (Lo)	When JPEG quality is set to  (Quality Level ★★★), pictures are taken continuously at approximately 1.1 fps until the SD Memory Card is full.



When the File Format is RAW, up to 4 frames for  (Continuous shooting (Hi)) or up to 7 frames for  (Continuous shooting (Lo)) can be taken continuously.

1 Press the four-way controller (▲) in Capture mode.

The [Drive Mode] screen appears.

2 Use the four-way controller (◀▶) to select .



3 Press the four-way controller (▼) and use the four-way controller (◀▶) to select or .



4 Press the OK button.

The camera returns to the status screen and is ready to take pictures continuously.



5 Press the shutter release button halfway.

The autofocus system operates. The focus indicator  appears in the viewfinder when focused.

6 Press the shutter release button fully.

Pictures are taken continuously while the shutter release button is fully pressed. Take your finger off the shutter release button to stop.



- If AF Mode is set to **AF.S** (Single mode), the focus position is locked on the first frame and pictures are taken continuously at the same interval.
- The shutter cannot be released until charging is complete when using the built-in flash. You can set the camera to enable shutter release before the built-in flash is ready in [14. Release when Charging] in the [C Custom Setting 2] menu. (p.71)
- Select a setting other than  or  in the [Drive Mode] screen to cancel continuous shooting. The setting is canceled when the camera is turned off if [Drive Mode] in [Memory] (p.229) of the [Rec. Mode 3] menu is set to (Off).

In Capture mode you can apply filter to take pictures.
The following filters are available.

Filter name	Effect	Parameter
Toy Camera	For taking pictures that look as if taken with a toy camera.	Shading Level: +1/+2/+3
		Blurring: +1/+2/+3
		Tone Break: Red/Green/Blue
High Contrast	For taking pictures with high contrasts.	+1/+2/+3
Soft	For taking pictures with a soft focus throughout the image.	+1/+2/+3
Star Burst	For taking pictures of night scenes or lights reflected on water with a special sparkling look achieved by adding cross-like effects to the picture's highlights.	Number of light sources: Small/Medium/Large
		Size: Short/Medium/Long
		Angle: 0°/30°/45°/60°
Retro	For taking pictures with the look of old photos.	Blue/Amber: -2/-1/Off/+1/+2
		White frame: Thin/Medium/Thick
Extract color	For extracting a specific color and taking the rest of the picture in black and white.	Red/Magenta/Cyan/Blue/Green/Yellow



- When using digital filters, the file format is always set to JPEG.
- Depending on the filter used, images may take longer to save.
- Continuous shooting and Auto Bracket shooting in Drive Mode are not available when using digital filters.

1

Press the OK button in the status screen.

The control panel appears.

Press the **INFO** button when the status screen is not displayed.

- 2** Use the four-way controller (▲▼◀▶) to select [Digital Filter] and press the OK button.

The screen for selecting the filter appears.



- 3** Use the four-way controller (◀▶) to select a filter.

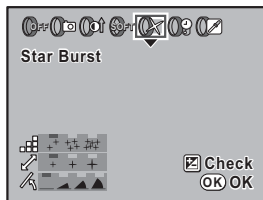

- 4** Use the four-way controller (▲▼) to select the parameter and the four-way controller (◀▶) to adjust the parameter's value.

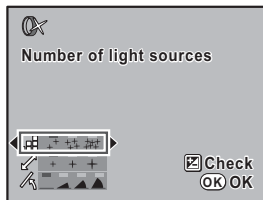

- 5** Press the OK button.

The camera returns to the status screen and is ready to take a picture.



- After you finish shooting using the digital filters, select [Not use any filters] in Step 3.
- You can also apply digital filter to images after shooting them in Playback mode (p.192).

Memo

5 Using the Flash

This chapter provides details on the built-in flash of the *K-m/K2000* and describes how to take pictures with the external flash.

Flash Characteristics in Each Exposure Mode	136
Distance and Aperture when Using the Built-in Flash	138
Lens Compatibility with the Built-in Flash	139
Using an External Flash (Optional)	140

Flash Characteristics in Each Exposure Mode

Using the Flash in Tv (Shutter Priority) Mode

- When taking a moving subject, you can use the flash to change the blur effect.
- Any desired shutter speed 1/180 sec. or slower can be set for taking a flash photograph.
- The aperture value automatically changes according to the ambient brightness.
- The shutter speed is locked at 1/180 sec. when lens other than DA, DA L, D FA, FA J, FA, F or A is used.

Using the Flash in Av (Aperture Priority) Mode

- You can set the desired aperture to take a flash photograph when you want to change the depth of field or shoot a subject farther away.
- The shutter speed automatically changes with the ambient brightness.
- The shutter speed shifts automatically anywhere from 1/180 sec. to a slow shutter speed (p.58) that reduces camera shake. The slowest shutter speed depends on the focal length of the lens in use.
- The shutter speed is locked at 1/180 sec. when lens other than DA, DA L, D FA, FA J, FA or F is used.

Using Slow-Speed-Sync

You can use slow-speed-sync in  (Night Scene Portrait) or **Tv** (Shutter Priority) mode when shooting portraits with the sunset in the background. Both the portrait and the background are captured beautifully.



- Slow-speed-sync slows the shutter speed. Use the Shake Reduction function or turn off the Shake Reduction function and use a tripod to avoid camera shake. The picture will also blur if the subject moves.
- Slow-speed-sync shooting can also be performed with an external flash.

Using Tv (Shutter Priority) Mode

1 Set the mode dial to Tv.

Tv (Shutter Priority) mode is set.

2 Use the e-dial to set the shutter speed.

The background is not properly exposed if aperture value is blinking when shutter speed is set. Set the shutter speed so that aperture value does not blink.

3 Press the **⚡UP** button.

The flash pops up.

4 Take a picture.

Using M (Manual) Mode

1 Set the mode dial to M.

M (Manual) mode is set.

2 Set the shutter speed and aperture value to obtain correct exposure.

Set 1/180 sec. shutter speed or slower.

3 Press the **⚡UP** button.

The flash pops up.

In M (Manual) mode, you can raise the flash at any time prior to shooting.

4 Take a picture.

Distance and Aperture when Using the Built-in Flash

Relationships between the guide number, aperture and distance must be considered when shooting with the flash to obtain the correct exposure. Calculate and adjust the shooting conditions if the flash output is not sufficient.

ISO Sensitivity	Built-in flash guide number
ISO 100	Approx. 11
ISO 200	Approx. 15.6
ISO 400	Approx. 22
ISO 800	Approx. 31.1
ISO 1600	Approx. 44
ISO 3200	Approx. 62.2

Calculating Shooting Distance from Aperture Value

The following equation calculates the distance of the flash for aperture values.

Maximum flash distance $L1 = \text{Guide number} \div \text{Selected aperture}$

Minimum flash distance $L2 = \text{Maximum flash distance} \div 5^*$

* The value 5 used in the formula above is a fixed value which applies only when using the built-in flash alone.

Example

When sensitivity is [ISO 100] and aperture value is F2.8

$L1 = 11 \div 2.8 = \text{approx. } 3.9 \text{ (m)}$

$L2 = 3.9 \div 5 = \text{approx. } 0.8 \text{ (m)}$

Therefore, the flash can be used in a range of about 0.8 m to 3.9 m.

The flash cannot be used when the distance is 0.7 m or less. When the flash is used at closer than 0.7 m, it causes vignetting in the picture corners, the light is distributed unevenly and the picture may be over-exposed.

Calculating Aperture Value from Shooting Distance

The following equation calculates the aperture value for shooting distances.

Aperture value used $F = \text{Guide number} \div \text{Shooting distance}$

Example

When sensitivity is [ISO 100] and shooting distance is 3.5 m, aperture value is:

$F = 11 \div 3.5 = 3.1$

If the resulting number (3.1, in the above example) is not available as a lens aperture, the smaller number that is closest (2.8, in the above example) is generally used.

Depending on the lens used with the **K-m/K2000**, even if a lens without a hood is attached, the use of the built-in flash may not be possible or may be limited due to vignetting.

DA, DA L, D FA, FA J, and FA lenses not listed below can be used without problems.

* Following are evaluated without a hood.

Unavailable due to vignetting

Lens Name
DA Fish-eye 10-17mm F3.5-4.5ED (IF)
DA12-24mm F4ED AL
DA14mm F2.8ED (IF)
FA★300mm F2.8ED (IF)
FA★600mm F4ED (IF)
FA★250-600mm F5.6ED (IF)

Available depending on other factors

Lens Name	Restrictions
F Fish-eye 17-28mm F3.5-4.5	Vignetting may occur if focal length is less than 20 mm.
DA16-45mm F4ED AL	When the focal length is less than 28 mm or when the focal length is 28 mm and the shooting distance is 1 m or less, vignetting may occur.
DA★16-50mm F2.8ED AL (IF) SDM	When the focal length is 20 mm or less or when the focal length is 35 mm and the shooting distance is less than 1.5 m, vignetting may occur.
DA17-70mm F4AL (IF) SDM	When the focal length is less than 24 mm or when the focal length is 24 mm and the shooting distance is 1 m or less, vignetting may occur.
DA18-250mm F3.5-6.3ED AL (IF)	Vignetting may occur if the focal length is less than 35 mm.
FA★28-70mm F2.8AL	Vignetting may occur if focal length is 28 mm and the shooting distance is less than 1 m.
FA Soft 28mm F2.8	Built-in flash always discharges fully.
FA Soft 85mm F2.8	Built-in flash always discharges fully.

Using an External Flash (Optional)

Using the optional external flash AF540FGZ, AF360FGZ, AF200FG or AF160FC enables a variety of flash modes, such as P-TTL auto flash mode, depending on the external flash being used. See the chart below for details.

(Yes: Available #: Restricted No: Not available)

Camera Function \ Flash	Built-in Flash	AF540FGZ AF360FGZ	AF200FG AF160FC
Red-eye reduction flash	Yes	Yes	Yes
Automatic flash discharge	Yes	Yes	Yes
After the flash is charged, the camera automatically switches to the flash sync speed.	Yes	Yes	Yes
Aperture is automatically set in P (Program) mode and Tv (Shutter Priority) mode.	Yes	Yes	Yes
Auto check in the viewfinder	No	No	No
P-TTL auto flash (appropriate sensitivity: ISO 100 to 3200)	Yes* ¹	Yes* ¹	Yes* ¹
Slow-speed sync	Yes	Yes	Yes
Flash exposure compensation	Yes	Yes	Yes
AF illuminator	Yes	Yes	No
Trailing curtain sync* ²	Yes	Yes	No
Contrast-control-sync flash mode	#* ³	Yes	#* ⁴
Slave flash	No	Yes	No
Multiple flash	No	No	No
High-speed flash sync	No	Yes	No
Wireless flash	#* ⁴	Yes* ⁵	No

*¹ Available only when using DA, DA L, D FA, FA J, FA, F or A lens.

*² Shutter speed of 1/90 sec. or slower.

*³ When combined with the AF540FGZ or AF360FGZ, 1/3 of the flash discharge can be output by the built-in flash and 2/3 can be output by the external flash.

*⁴ Available only when combined with the AF540FGZ or AF360FGZ.

*⁵ Multiple AF540FGZ or AF360FGZ units or a combination of an AF540FGZ/AF360FGZ unit and the built-in flash is required.

About the LCD Panel Display for AF360FGZ

The AF360FGZ itself does not have the function to set the FORMAT size to [DIGITAL]. However, when it is used with a SLR Digital Camera, the difference in focal length between 35 mm film camera and the **K-m/K2000** is automatically calculated based on the difference in angle of view (when using DA, DA L, D FA, FA J, FA or F lenses).

The conversion indicator appears and the format size indicator disappears when the exposure metering timer of the **K-m/K2000** is on (it returns to 35 mm format display when the exposure metering timer is turned off).

Lens focal length		85mm	77mm	50mm	35mm	28mm	24mm	20mm	18mm
AF360FGZ LCD panel	Exposure metering timer Off	85mm	70mm	50mm	35mm	28mm	24mm	20mm	18mm*
	Exposure metering timer On	58mm	48mm	34mm	24mm	19mm	16mm*	14mm	12mm*





* Using wide-angle panel

Using P-TTL Auto Mode

You can use [P-TTL Auto] with the AF540FGZ, AF360FGZ, AF200FG or AF160FC flash unit. The flash pre-flashes before the actual flash and confirms the subject (the distance, brightness, contrast, whether it is backlit, etc.) using the camera 16-segment metering sensor. The flash output for the actual flash is adjusted based on the information obtained from the pre-flash, enabling flash photography with more appropriate exposure for the subject than with normal TTL auto.

- 1 Remove the cover of the hot shoe and attach the external flash.
- 2 Turn on the camera and the external flash.
- 3 Set the external flash mode to [P-TTL auto].
- 4 Confirm that the external flash is fully charged and then take a picture.



- P-TTL auto is only available with the AF540FGZ, AF360FGZ, AF200FG or AF160FC flash unit.
- The  will light in the viewfinder when the flash is ready (fully charged).
- For details such as operation method and effective distance, please read the external flash manual.
- The flash does not discharge when the subject is bright enough when Flash Mode is  or . Therefore, it may not be suitable for daylight-sync shooting.
- Never press the  button when any external flash unit is attached to the camera. The built-in flash will hit the external flash. If you want to use both at once, see p.146 for the connection method.

Using High-Speed Flash Sync Mode

With the AF540FGZ or AF360FGZ, you can discharge the flash to take a picture at a shutter speed faster than 1/180 second.

5

Attaching and Using the AF540FGZ or AF360FGZ

- 1 Remove the cover of the hot shoe and attach the external flash (AF540FGZ or AF360FGZ) to the camera.
- 2 Set the exposure mode to **Tv** (Shutter Priority) or **M** (Manual).
- 3 Turn on the camera and the external flash.
- 4 Set the external flash sync mode to HS  (high-speed flash sync).
- 5 Confirm that the external flash is fully charged and then take a picture.



- The  will light in the viewfinder when the flash is ready (fully charged).
- High-speed flash sync is available only when the shutter speed is faster than 1/180 sec.
- High-speed flash sync is not available when the shutter speed is set to **Bulb**.

Using in Wireless Mode

By using two external flashes (AF540FGZ or AF360FGZ) or using the built-in flash with an external flash, you can shoot in P-TTL flash mode without connecting the flash units with a cord.



- Set the power switch of the external flash to WIRELESS.
- Two or more AF540FGZ/AF360FGZ external flashes are required to use high-speed flash sync in Wireless Mode. This function cannot be used in combination with the built-in flash.
- Set the wireless mode of the external flash not directly connected to the camera to SLAVE.

Setting the Channel for the External Flash

First set the channel for the external flash unit.

- 1 Set the channel for the external flash unit.
- 2 Attach the external flash to the camera hot shoe.
- 3 Turn on the camera and the external flash, and press the shutter release button halfway.

The built-in flash is set to the same channel as the external flash unit.



- When set to **W^L** mode, the channel currently set for the built-in flash is displayed in the viewfinder for 10 seconds.
- Be sure to set all the flashes to the same channel. Refer to the AF540FGZ or AF360FGZ operating manual for details on how to set the channel on the external flash.

Using the Built-in Flash in Wireless Mode

Set the camera to wireless flash mode when using an external flash in combination with the built-in flash.

- 1 Press the four-way controller (▼).
The [Flash Mode] screen appears.
- 2 Use the four-way controller (◀▶) to select **W^L** mode.
Press the **OK** button to return to Capture mode.

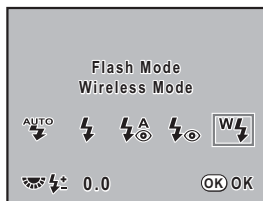

When Drive Mode is set to **ī_{ss}** or the lens aperture is not set to the **A** position, **W^L** appears gray and cannot be selected.

● Changing the Built-in Flash Discharge Method

You can change the built-in flash discharge method in Wireless Mode. Set in [15. Flash in Wireless Mode] in the [C Custom Setting 3] menu (p.79).

1	On	Discharges the built-in flash.
2	Off	Discharges the built-in flash as a control flash.



HS (High-speed sync) is not available with the built-in flash.

Wireless Shooting

● Using a Combination of the Built-in Flash and an External Flash Unit

- 1 Remove the external flash unit after the channel was set on the camera, and place at the desired location.
- 2 Set the camera flash to mode, and pop up the built-in flash.
- 3 Confirm that both flashes are fully charged and then take a picture.

● Using a Combination of External Flash Units

- 1 Set the wireless mode of the external flash directly connected to the camera to [MASTER] or [CONTROL].

MASTER	Discharges both the flash directly connected to the camera and the wireless flash unit.
CONTROL	The flash directly connected to the camera is discharged as a control flash only and does not discharge as main flash.

- 2 On the wireless remote flash unit, set the wireless flash mode to [SLAVE] and set the channel to the same channel as the flash directly connected to the camera. Then, place at the desired location.
- 3 Confirm that both flashes are fully charged and then take a picture.



Shake Reduction is not available in Wireless Mode.

Wireless Flash Control (P-TTL Flash Mode)

When using external flash units (AF540FGZ or AF360FGZ) for wireless shooting, the following information is exchanged between the flash units before the flash is discharged.

Press the shutter release button fully.



- 1 The flash directly connected to the camera emits a control flash (relays the flash mode of the camera).
- 2 The wireless remote flash emits a test flash (relays confirmation of subject).
- 3 The flash directly connected to the camera emits a control flash (relays flash output to the wireless remote flash).
 - * The flash directly connected to the camera will emit a control flash one more time after this to relay the flash duration time when HS $\frac{1}{2}$ (High-speed sync) is set.
- 4 The wireless remote flash discharges at the same time as the main flash.



When the wireless mode of the external flash directly connected to the camera is set to [MASTER] or [15. Flash in Wireless Mode] (p.144) is set to [On] for the built-in flash, all the flashes will discharge simultaneously.

Red-Eye Reduction

As with the built-in flash, red-eye reduction is available with an external flash. This may not be available on some flashes or may have restrictions for usage conditions. See the chart on p.140.



- The red-eye reduction feature works even when only an external flash is used. (p.69)
- If red-eye reduction of the built-in flash is used when the external flash is set as the slave unit or with the wireless function, the preflash for red-eye reduction will trigger the external flash. Do not use red-eye reduction when using a slave unit.

Trailing Curtain Sync

When using the built-in flash with an external flash (AF540FGZ or AF360FGZ) that is set to the Trailing curtain sync function, the built-in flash will also use this mode. Confirm that both flash units are fully charged before shooting.

Using the Built-in Flash with the External Flash

When using the built-in flash with an external flash that does not have wireless flash mode function such as AF200FG, attach the Hot Shoe Adapter F_G (optional) to the camera hot shoe and an Off-Camera Shoe Adapter F (optional) to the bottom of the external flash, and connect these with the Extension Cord F5P (optional) as shown in the illustration below. The Off-Camera Shoe Adapter F can be mounted using the tripod screw to your tripod.

Only the P-TTL auto flash can be used in combination with the built-in flash.

When combining with the built-in flash

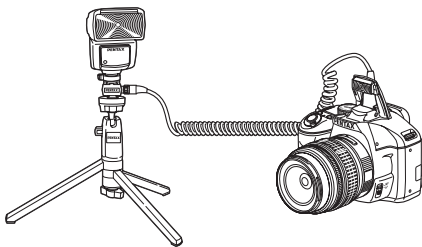

Discharging Multiple Flashes

You can combine two or more external flashes (AF540FGZ, AF360FGZ or AF200FG) or you can use two or more external flashes in combination with the built-in flash. You can use the extension cord connection terminal on the flash to connect the AF540FGZ. You can connect AF360FGZ or AF200FG units as shown in the illustration below. Connect an external flash and the Hot Shoe Adapter F (optional) to the Off-Camera Shoe Adapter F (optional) and then connect another Off-Camera Shoe Adapter F with external flash using the Extension Cord F5P (optional). Refer to the flash manual for details.



- Do not combine with accessories that have a different number of contacts such as a Hot Shoe Grip as a malfunction may occur.
- Combining with flashes from other manufacturers may cause equipment breakdown. We recommend using the AF540FGZ, AF360FGZ or AF200FG.

When combining two or more external flashes

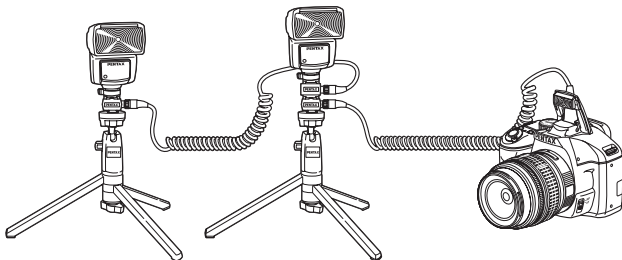

When using multiple external flashes or an external flash with the built-in flash, P-TTL is used for flash control.

Contrast-Control-Sync Flash

Combining two or more external flashes (AF540FGZ, AF360FGZ or AF200FG) or using an external flash in combination with the built-in flash allows multiple flash photography (contrast-control-sync flash photography). This is based on the difference between the amounts of light discharged from multiple units.



- The AF200FG must be combined with the AF540FGZ or AF360FGZ.
- Do not combine with accessories that have a different number of contacts such as a Hot Shoe Grip as a malfunction may occur.
- Combining with flashes from other manufacturers may cause equipment breakdown. We recommend using PENTAX automatic flashes.

- 1 Connect the external flash to the camera indirectly. (p.146)
- 2 Set the sync mode for the external flash to the contrast-control-sync mode.
- 3 Set the exposure mode to **P**, **Tv**, **Av** or **M**.
- 4 Confirm that both the external flash and built-in flash are fully charged and then take a picture.



- When using two or more external flashes and the contrast-control-sync mode is set on the external master flash unit, the flash output ratio is 2 (master unit) : 1 (slave units). When external flash is used in combination with the built-in flash, the flash output ratio is 2 (external flash) : 1 (built-in flash).
- When using multiple external flashes or an external flash with the built-in flash, P-TTL is used for flash control.

6 Shooting Settings

This chapter describes how to set the save format for pictures taken and other settings.

Setting the File Format	150
Setting the  Button Function	154
Setting the Image Finishing Tone (Custom Image)	157
Additional Settings for Shooting	159

Setting the JPEG Recorded Pixels

You can select the number of recorded pixels from **10M**, **6M** and **2M**. The more pixels there are, the larger the picture and the bigger the file size. The file size will also differ according to the [JPEG Quality] setting. The default setting is **10M**.

Recorded Pixels	Pixels	Paper Size
10M	3872×2592	10"×12" / A3 paper
6M	3008×2000	8"×10" / A4 paper
2M	1824×1216	5"×7" / A5 paper

The paper sizes above are references for optimal printing by recorded pixels. The quality of the captured photo or printed picture depends on the quality level, exposure control, resolution of the printer and a variety of other factors.

6

Shooting Settings

1 Press the **OK** button in the status screen.

The control panel appears.

Press the **INFO** button when the status screen is not displayed.

2 Use the four-way controller (▲▼◀▶) to select [JPEG Rec. Pixels] and press the **OK** button.

The [JPEG Rec. Pixels] screen appears.

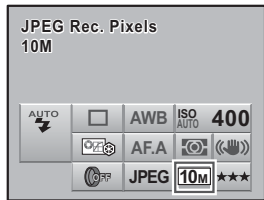

3 Use the four-way controller (◀▶) to select the number of recorded pixels.

When the number of recorded pixels is changed, the number of recordable images appears at the top right of the screen.

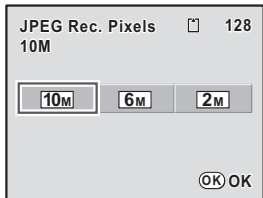

4 Press the OK button.

The camera returns to the status screen and is ready to take a picture.

Setting the JPEG Quality Level

You can set the image quality level. The file size will also differ according to the [JPEG Rec. Pixels] setting. The default setting is ★★★ (Best).

★★★	Best	↑ Images will be clearer but file size will be larger. ↓ Images will be grainier but file size will be smaller.
★★	Better	
★	Good	

1 Press the OK button in the status screen.

The control panel appears.

Press the **INFO** button when the status screen is not displayed.

2 Use the four-way controller (▲▼◀▶) to select [JPEG Quality] and press the OK button.

The [JPEG Quality] screen appears.

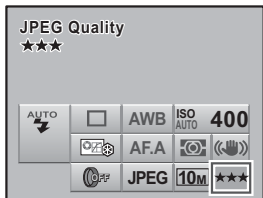

3 Use the four-way controller (◀▶) to select a quality level.

When the quality level is changed, the number of recordable images at that quality level appears at the top right of the screen.



4 Press the OK button.

The camera returns to the status screen and is ready to take a picture.

Setting the File Format

You can set the format of image files. The default setting is JPEG.

JPEG	Captures images in JPEG format. You can change the number of recorded pixels in [JPEG Rec. Pixels], and the image quality level in [JPEG Quality]. The file size varies according to the settings.
RAW	RAW data is CCD output data saved without processing. Effects such as White Balance, Custom Image and Color Space are not applied to the image but such information is saved. Use RAW Development (p.195) or transfer to a computer, apply effects with the enclosed PENTAX PHOTO Laboratory 3 and create a JPEG or TIFF image.
RAW+	Image is saved in both RAW and JPEG formats. When the RAW button function is assigned to the ? (Help) button, you can press the ? button to temporarily change the file format and save the image in both file formats.

1 Press the OK button in the status screen.

The control panel appears.

Press the **INFO** button when the status screen is not displayed.

- 2 Use the four-way controller (▲▼◀▶) to select [File Format] and press the OK button.**

The [File Format] screen appears.

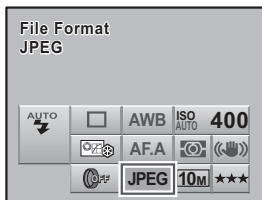

- 3 Use the four-way controller (◀▶) to select a file format.**

When the file format is changed, the number of recordable image appears at the top right of the screen.

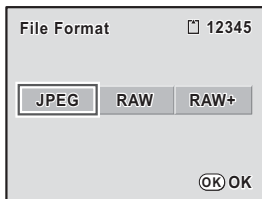

- 4 Press the OK button.**

The camera returns to the status screen and is ready to take a picture.

Setting the RAW File Format

You can select PEF or DNG format in [RAW file format] in the [📷 Rec. Mode 1] menu (p.77) when images are captured in RAW format. The default setting is [PEF].

PEF	PENTAX original RAW file format
DNG	General-purpose, publicly available RAW file format designed by Adobe Systems

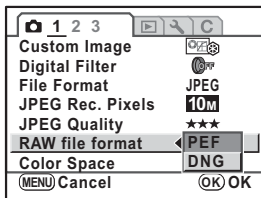

Setting the ? Button Function

Any of the following functions can be assigned to the ? (Help) button: Help function, Digital Preview, Custom Image, Digital Filter and RAW button function. While shooting, you can access the function assigned simply by pressing the button.

Help function	Displays an explanation of the current operation. (p.34)
Digital Preview	Displays the Digital Preview. You can set whether or not to display the histogram and Bright/Dark area warning during Digital Preview. (p.119)
Custom Image	Sets the Custom Image settings. (p.157)
Digital Filter	Sets the digital filter. (p.132)
RAW button function	Simultaneously saves the image in both JPEG and RAW format, regardless of the [File Format] setting. You can select whether the setting applies to only one image and the file format when the button is pressed. (p.155)

6

- 1 Select [Help button] in the [Rec. Mode 3] menu and press the four-way controller (▶).

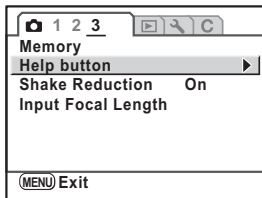

- 2 Press the four-way controller (▶).

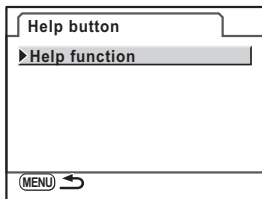

- 3** Use the four-way controller (▲▼) to select a function to assign to the  (Help) button, and press the OK button.

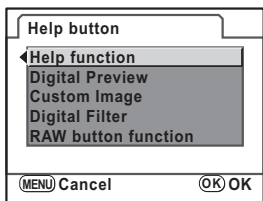

- 4** Press the MENU button twice.

The screen that was displayed before selecting the menu appears again.

Setting the RAW Button Function

When the [RAW button function] is assigned to the  (Help) button, adjust the function settings.

The following settings are available.

Cancel each time	<input checked="" type="checkbox"/> (On)/ <input type="checkbox"/> (Off)
File Format	File format selected when the  button is pressed.

- 1** Select [RAW button function] in Step 3 on p.155.
- 2** Use the four-way controller (▲▼) to select [Cancel each time].

3 Use the four-way controller (◀▶) to select (On) or (Off).

When set to (On), the recording format each time a picture is taken returns to the [File Format] setting. The default setting is (On). When [Cancel each time] is set to (Off), the  button settings are canceled under the following conditions.

- the  button is pressed again
- the camera is turned off
- the mode dial is turned
- a menu is displayed
- the camera is in Playback mode

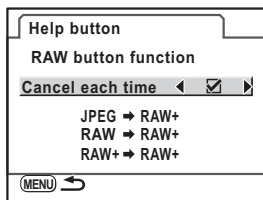

4 Use the four-way controller (▲▼) to choose a file format.

The left side is the [File Format] setting and the right side is the file format when the  button is pressed.

5 Press the four-way controller (▶), and use the four-way controller (▲▼) to select a file format when the button is pressed.

6 Press the OK button.

7 Press the MENU button twice.

The screen that was displayed before selecting the menu appears again.

Setting the Image Finishing Tone (Custom Image)

You can set the image finishing tone before shooting when the exposure mode is set to **P** (Program), **Sv** (Sensitivity Priority), **Tv** (Shutter Priority), **Av** (Aperture Priority) or **M** (Manual).

Select from the following six modes for [Image Tone]: Bright, Natural, Portrait, Landscape, Vibrant and Monochrome. The default setting is [Bright]. You can adjust the following items for Image Tone.

Saturation* ¹	Sets the color saturation. (Available settings: -4 to +4)
Hue* ¹	Sets the color. (Available settings: -4 to +4)
Contrast	Sets the image contrast. (Available settings: -4 to +4)
Sharpness* ²	Sets the sharpness of the image outlines. (Available settings: -4 to +4)
Filter Effect* ³	Changes the contrast to appear as if a B&W color filter was used. Sets the filter color. (Available settings: [None], [Green], [Yellow], [Orange], [Red], [Magenta], [Blue], [Cyan], [Infrared Color])
Toning* ³	Sets the level for cold tone adjustment (- direction) and warm tone adjustment (+ direction). (Available settings: -4 to +4)

*1 This can be set when any mode other than [Monochrome] is selected.

*2 You can also change the setting to [Fine Sharpness], which makes image outlines even thinner and sharper.

*3 This can be set when [Monochrome] is selected.

1 Press the **OK** button in the status screen.

The control panel appears.

Press the **INFO** button when the status screen is not displayed.

2 Use the four way controller (▲▼◀▶) to select a custom image and press the **OK** button.

The [Custom Image] screen appears.

After the power is turned on, the last image taken is displayed in the background.



- 3** Use the four-way controller (◀▶) to select Image Tone.

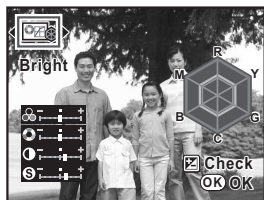

- 4** Use the four-way controller (▲▼) to choose an item you want to change (Saturation, Hue, Contrast or Sharpness).

When Image Tone is set to Monochrome, you can change the settings for Filter Effect, Toning, Contrast, and Sharpness.

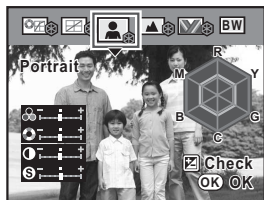

- 5** Use the four-way controller (◀▶) to change the setting.

The background image changes according to the setting.

You can visually check the saturation and hue with the radar chart.

For Sharpness, turn the e-dial to switch to Fine Sharpness. The image outlines are even thinner and sharper with Fine Sharpness, making it suited for capturing fine subjects such as hair.

- 6** Press the OK button.







The camera returns to the status screen and is ready to take a picture.



When Image Tone is set to Monochrome, the radar chart is not displayed.

Setting the White Balance

White balance is the function for adjusting the color of an image so that white objects appear white. Set the white balance if you are not satisfied with the color balance of pictures taken with white balance set to **AWB** (Auto), or to intentionally apply a creative effect to your images. The default setting is **AWB** (Auto).

AWB	Auto	Automatically adjusts the white balance. (About 4000 to 8000K)
	Daylight	For use when taking pictures in sunlight. (About 5200K)
	Shade	For use when taking pictures in the shade. It reduces the bluish color tones in a picture. (About 8000K)
	Cloudy	For use when taking pictures on cloudy days. (About 6000K)
	Fluorescent Light	For use when taking pictures under fluorescent lighting. Select the type of fluorescent light, from D (daylight) (about 6500K), N (neutral white) (about 5000K), and W (white) (about 4200K).
	Tungsten Light	For use when taking pictures under light bulb or other tungsten light. It reduces the reddish color tones in a picture. (About 2850K)
	Flash	For use when taking pictures using the built-in flash. (About 5400K)
	Manual	Use this to manually adjust the white balance according to the lighting so that white objects appear as a natural white.

* The color temperature (K) is an estimate. This does not indicate precise colors.

- 1** Set the mode dial to **P**, **Sv**, **Tv**, **Av**, or **M**.
- 2** Press the four-way controller () in Capture mode.
The [White Balance] screen appears.

3 Press the four-way controller (▲▼) and set.

Press the  **Av** button to display the Digital Preview using the white balance set. Fine-tuning White Balance is easier with Digital Preview.

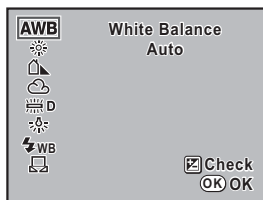

4 Press the OK button.

The camera returns to the status screen and is ready to take a picture.



- White balance cannot be adjusted in Picture mode and **SCN** (Scene) mode.
- Because the light source changes when the flash discharges, you can set the white balance for when the flash discharges. Select [Flash] or [Unchanged] in [16. WB when using flash] in the [C Custom Setting 3] menu (p.79).

Color Temperature

The color of light shifts towards blue as the color temperature rises, and towards red as the color temperature falls. Color temperature describes this change in light color in terms of absolute temperature (K: Kelvin). This camera is capable of setting the white balance to enable taking pictures with natural coloring under a variety of lighting conditions.

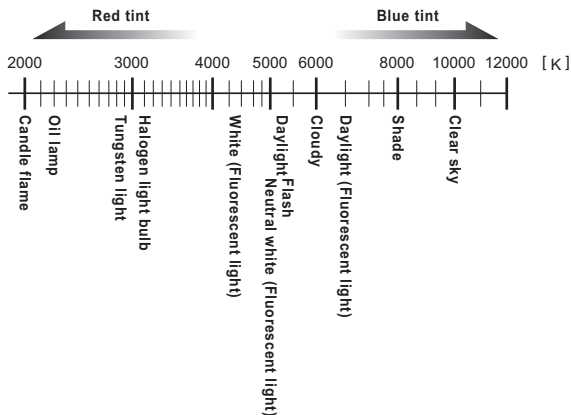

Adjusting the White Balance Manually

You can adjust the white balance depending on the light source when taking pictures. With Manual White Balance, the camera can store delicate shades that cannot be precisely adjusted with the white balance preset values provided in the camera. This provides the optimum white balance for your surroundings.

- 1** Select  (Manual) in Step 3 on p.160.

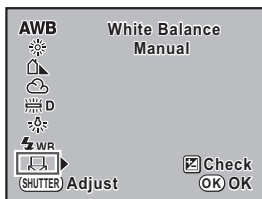

- 2** Under the light to measure the white balance, fully display a white sheet of paper in the viewfinder or select a white area as the subject.

- 3** Press the shutter release button fully.

Slide the focus mode lever to **MF** when the shutter cannot be released.

The screen to select the measuring range is displayed.



- 4** Use the e-dial to select the entire screen or spot area for the measuring range.

- 5** When a spot area is selected, use the four-way controller (▲▼◀▶) to move the frame to the area you want to measure.



6 Press the OK button.

The camera returns to the [White Balance] screen.

Tune using steps in “Fine-Tuning the White Balance” if fine-tuning is necessary.

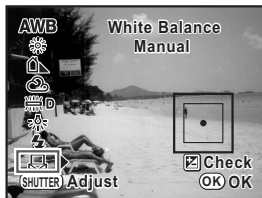

7 Press the OK button.

The camera is ready to take a picture with the set White Balance.



- No image is recorded when the shutter release button is pressed to adjust the white balance.
- [NG] appears when measuring is unsuccessful. Press the **OK** button while displayed to return to the [Adjust White Balance] screen for remeasuring.
- If the picture is extremely overexposed or underexposed, white balance may not be adjusted. In this case, adjust appropriate exposure and adjust the white balance.

Fine-Tuning the White Balance

You can fine tune the white balance settings.

1 Set [8. Adjust White Balance] in the [C Custom Setting 2] menu to [On].

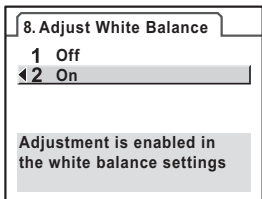

2 Perform desired settings in Steps 1 to 3 on p.159.

3 Press the four-way controller (▶).

The [Adjust White Balance] screen appears.

4 Use the four-way controller (▲▼◀▶) to fine tune White Balance.

Seven levels and 225 patterns are available on the G-M and B-A axes.

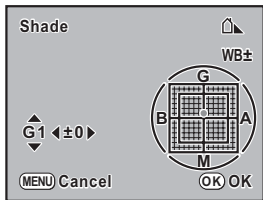

G-M	Adjusts the tone of the colors between green and magenta.	▲▼
B-A	Adjusts the tone of the colors between blue and amber.	◀▶

5 Press the OK button.

The camera returns to the [White Balance] screen.

6 Press the OK button.

The camera returns to the status screen and is ready to take a picture.



- If [8. Adjust White Balance] in the [C Custom Setting 2] menu is set to [Off] after White Balance is adjusted, the adjusted values become invalid. Set [8. Adjust White Balance] to [On] again to enable the values used previously.
- When set to (Manual), White Balance can also be measured in the [Adjust White Balance] screen by pressing the shutter release button fully.

Setting the Color Space

You can set the color space to use. The default setting is [sRGB].

1	sRGB	Sets to sRGB color space.
2	AdobeRGB	Sets to AdobeRGB color space.

Set [Color Space] in the [📷 Rec. Mode 1] menu (p.77).

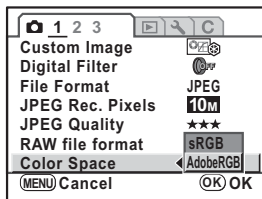

File names differ depending on the color space setting as shown below.

For sRGB : IMGpxxxx.JPG

For AdobeRGB : _IGPxxxx.JPG

[xxxx] indicates the file number. This is displayed as a four-digit sequential number. (p.224)

Color Space

Color ranges for various input/output devices, such as digital cameras, monitors, and printers, differ. This color range is called the Color Space.

To recreate different color spaces in different devices, standard color spaces have been proposed. This camera supports sRGB and AdobeRGB.

sRGB is mainly used for devices such as a computer.

AdobeRGB covers a wider area than sRGB and is used for occupational uses such as industrial printing.

An image created in AdobeRGB may appear lighter than an image created in sRGB when output from an sRGB compatible device.

7 Playback Functions

This chapter describes how to use the various playback functions in Playback mode.

Playback Functions Operation	166
Enlarging Images	167
Displaying Multiple Images	169
Rotating Images	175
Comparing Images	176
Slideshow	177
Deleting Multiple Images	180
Protecting Images from Deletion (Protect)	184
Connecting the Camera to AV Equipment	186

Perform settings related to playing back images in the [▶ Playback] menu.



For details on how to operate the menus, see "Using the Menus" (p.32).

Playback Menu Setting Items

You can perform the following settings in the [▶ Playback 1-2] menu. Press the **MENU** button in Playback mode. The [▶ Playback 1] menu appears.

Menu	Item	Function	Page
▶ 1	Slideshow	Plays back saved images one after another.	p.177
	Image Comparison	You can display two images side-by-side.	p.176
	Digital Filter	Changes the color tone of captured images, adds softening and slimming effects, or adjusts the brightness.	p.192
	Resize	Changes the recorded pixels and quality level to create an image with a smaller file size.	p.188
	Cropping	Cuts out only the desired area of the picture and saves it as a new image.	p.190
	Protect	Protects images from being accidentally erased.	p.184
	DPOF	Sets the DPOF settings.	p.200
▶ 2	RAW Development	Converts RAW images to JPEG format.	p.195
	Index	Joins a number of saved images together and creates a new image from them.	p.172
	Playback dsp. methd.	Sets whether to display the Bright/Dark area warning in Playback mode and also sets the initial magnification when enlarging images.	p.168
	Multi-img dsp. stngs.	Sets the number of images to display in a multi-image display screen to 4, 9 or 16.	p.170
	Delete All	You can delete all saved images at once.	p.183

Images can be magnified up to 16 times in playback mode.

- 1** Press the  button and use the four-way controller ( ) to select an image.

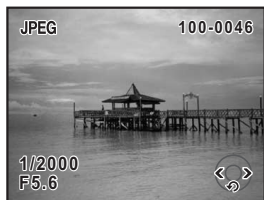





- 2** Turn the e-dial to the right (toward ) .

The image enlarges at each calibration (1.2 times to 16 times).



Operations available during Enlarged view

Four-way controller (   )	Moves area to enlarge
e-dial (toward right)	Enlarges image (up to 16 times)
e-dial (toward left)	Reduces image (up to 1.2 times*)
OK button	Returns to the original size
INFO button	Switches information display On/Off

* The default setting for the first click (minimum magnification) on the e-dial (toward right) is 1.2 times. You can change this in [Playback dsp. methd.] in [ Playback 2] menu.



- You can enlarge the image by following the same procedure during Instant Review (p.61) and Digital Preview (p.119).
- The initial full display of vertical images is displayed with a magnification of 0.75 times that of horizontal images, therefore, magnification at the first click starts at 1.0 times.

Setting the Playback Display Method

You can set whether or not to display the Bright/Dark area warning in Playback mode and set the initial magnification when enlarging images.

- 1 Select [Playback dsp. methd.] in the [▶ Playback 2] menu.

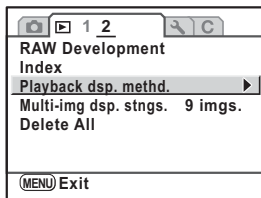

- 2 Press the four-way controller (▶).

- 3 Use the four-way controller (◀▶) to select (On) or (Off) for [Bright/Dark area].

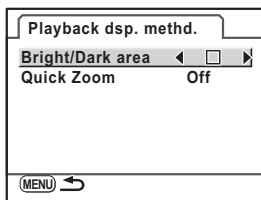

- 4 Use the four-way controller (▼) to select [Quick Zoom].

- 5 Press the four-way controller (▶) and use the four-way controller (▲▼) to select a magnification.

Select from [Off], [×2], [×4], [×8] or [×16].

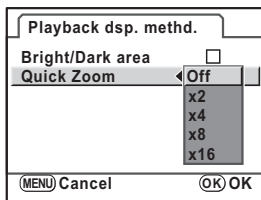

- 6 Press the OK button.

- 7 Press the MENU button twice.

The screen that was displayed before selecting the menu appears again.





Multi-image Display Screen

You can display 4, 9 or 16 images on the monitor at the same time. The default setting is 9-image display. The number of images can be changed but 9-image display is explained here.

1 Press the button.



2 Turn the e-dial to the left (toward).

The multi-image display screen appears. Up to nine thumbnail images will be displayed at once. Use the four-way controller (   ) to select an image. A scroll bar appears at the right of the screen. With an image selected in the bottom row, pressing the four-way controller () displays the next nine images.

[?] appears for an image that cannot be displayed.

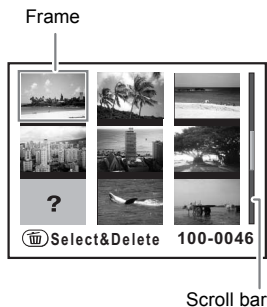

- 3** Turn the e-dial to the right (towards ) or press the OK button.

A full screen display of the selected image appears.



Selecting the Number of Images to Display

- 1** Select [Multi-img dsp. stngs.] in the [▶ Playback 2] menu.

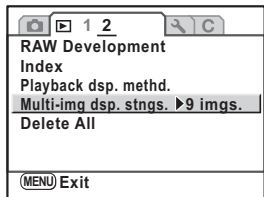

- 2** Press the four-way controller (▶), use the four-way controller (▲▼) to select the number of images to be displayed in one screen and press the OK button.

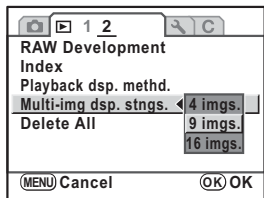

- 3** Press the MENU button.

The screen that was displayed before selecting the menu appears again.

Calendar Display/Folder Display

You can display images by recording date or by folder name.

Displaying Images by Recording Date

Images will be grouped and displayed by recording date.

- 1 Turn the e-dial to the left (toward ) in the multi-image display screen.



The calendar display screen appears.

Only dates when pictures were taken are displayed.

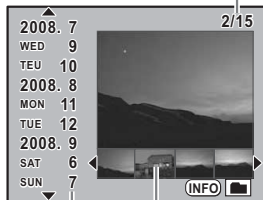
Number of images recorded
in this date



Recording date Thumbnail

- 2 Use the four-way controller ( ) to select the recording date.

- 3 Use the four-way controller ( ) to select an image.

Press the **OK** button to display the image selected in single-image playback.

Displaying Images by Folder

Images will be grouped and displayed by the folder in which they are saved.

- 1 Turn the e-dial to the left (toward ) in the multi-image display screen.

The calendar display screen appears.

2 Press the INFO button.

The folder display screen appears.

3 Use the four-way controller (▲▼◀▶) to select a desired folder and press the OK button.

The multi-image display screen for the selected folder appears.

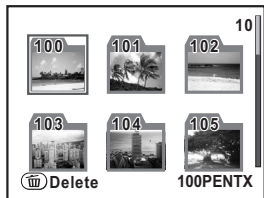

- You can press the button to delete the selected folder and all the images in it. (p.182)
- Press the **INFO** button to switch between the calendar display and folder display. The next time Calendar Display/Folder Display is selected, the one that was displayed most recently will be displayed first.

Joining Multiple Images (Index)

Join a number of saved images together and display them as an index print. You can also save the displayed index print as a new image. You can select the images to include in the index print and have them randomly-disposed.

1 Select [Index] in the [▶ Playback 2] menu.

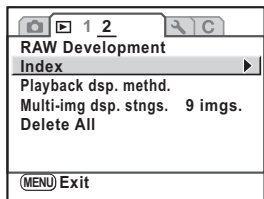

2 Press the four-way controller (▶).

The [Index] screen appears.

3 Press the four-way controller (▶).

- 4** Use the four-way controller (▲▼) to select a layout and press the OK button.

You can select one of 5 index layouts:
 Thumbnails/Square/Random 1/Random 2/Random 3.

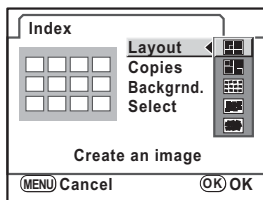

- 5** Use the four-way controller (▲▼) to select [Copies] and press the four-way controller (▶).

- 6** Use the four-way controller (▲▼) to select the number of images and press the OK button.

You can select 12, 24 or 36 images.

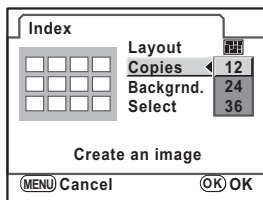

- 7** Use the four-way controller (▲▼) to select [Backgrnd.] and press the four-way controller (▶).

- 8** Use the four-way controller (▲▼) to select a background color and press the OK button.

You can select a white or black background.

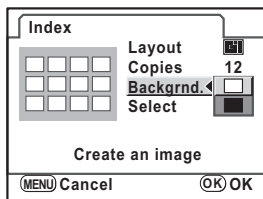

- 9** Use the four-way controller (▲▼) to select [Select] and press the four-way controller (▶).

10 Use the four-way controller (▲▼) to select the type of image selection and press the OK button.

- (All images):
Picks up images automatically from all of the images saved.
- (Manual):
Individually select the images you want to include in the index.
- (Folder name):
Picks up images automatically from the folder selected.

If you selected , continue by selecting [Select image(s)] and selecting the individual images.

If you selected , continue by selecting [Select a folder] and selecting the folder.

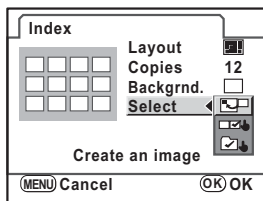

11 Use the four-way controller (▲▼) to select [Create an image] and press the OK button.

The index print is created and a confirmation screen appears.

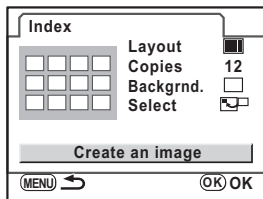

12 Use the four-way controller (▲▼) to select [Save] or [Reshuffle] and press the OK button.

- Save:**
The index image is saved as **6M** file.
- Reshuffle:**
Reselects the images included in the index and displays a new index image.

After the index is saved, the camera returns to Playback mode and the index image is displayed.

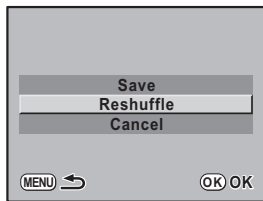

- Processing may take a while when creating an index print.
- When the number of saved images is smaller than the number set for [Copies], empty spaces will appear in [Thumbnails] layout and some images may be duplicated in other layouts.
- The images are positioned in order starting from the smallest file number when Thumbnails or Square is selected.

You can rotate the image displayed 90° counterclockwise at a time before saving it. The image rotation information is saved with the image and during playback it will be displayed in portrait orientation.



You cannot save the image rotation information for protected images.

1 Press the  button and use the four-way controller (◀▶) to display the image you want to rotate.

2 Press the four-way controller (▼).

The image is rotated 90° counterclockwise each time the button is pressed.

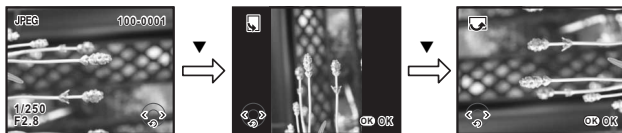

3 Press the **OK** button.

The image rotation information is saved.

You can display two images side-by-side.

- 1 **Select [Image Comparison] in the [▶ Playback 1] menu.**

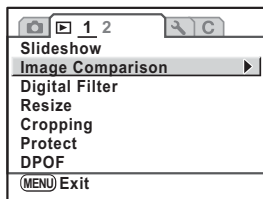

- 2 **Press the four-way controller (▶).**

The last image displayed/captured will be displayed twice side-by-side.

- 3 **Turn the e-dial to select an image to compare.**

You can change the display with the following procedures.



OK button	The selection frame changes to right image, both images, and left image each time the button is pressed.
Four-way controller (▲▼◀▶)	Moves area to enlarge. When the selection frame is selecting both images, you can operate both images at the same time.
e-dial	When the selection frame is selecting the left or right image, the previous/next image is displayed. When the selection frame is selecting both images, you can enlarge or reduce both images simultaneously in the same magnification.
INFO button	Switches information display On/Off.
🗑️ button	When the selection frame is selecting the left or right image, the selected image is deleted.

- 4 **Press the MENU button.**

The camera returns to the normal playback mode.

You can play back all images saved on your SD Memory Card successively.

Setting the Slideshow Display

Sets how images will be displayed during the Slideshow.

- 1 Select [Slideshow] in the [▶ Playback 1] menu.

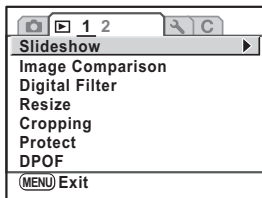

- 2 Press the four-way controller (▶).

- 3 Use the four-way controller (▲ ▼) to select the setting you want to change.

The following settings can be changed.

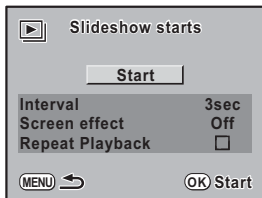

Item	Function	Setting
Interval	Select the image display interval.	3/5/10/30 seconds (Default setting: 3 sec.)
Screen effect	Select the transition effect when the next image is displayed.	Off/Fade/Wipe/Zoom (Default setting: Off)
Repeat Playback	Sets whether the slideshow will start from the beginning after the last image is displayed.	<input type="checkbox"/> (Off)/ <input checked="" type="checkbox"/> (On) (Default setting: <input type="checkbox"/> (Off))

- 4** Press the four-way controller (▶) and use the four-way controller (▲▼) to change the settings.

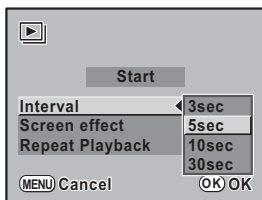

Starting the Slideshow

- 1** Select [Start] in Step 3 of p.177 and press the OK button.

The Start screen is displayed and slideshow begins.

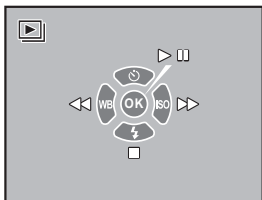

Operations available during a slideshow

OK button	Pause
Four-way controller (◀)	Shows previous image
Four-way controller (▶)	Shows next image
Four-way controller (▼)	Stop

Operations available when paused

OK button	Resumes playback (Restart)
Four-way controller (◀)	Shows previous image
Four-way controller (▶)	Shows next image
Four-way controller (▼)	Stop

2 Stop the slideshow.

Slideshow ends when one of the following is performed during playback or when paused.

- Four-way controller (▼) is pressed *1
-  button is pressed *1
- **MENU** button is pressed *1
- Shutter release button is pressed halfway or fully *2
- Mode dial is turned *2

*1 After slideshow ends, the camera returns to the normal playback mode.

*2 After slideshow ends, the camera returns to Capture mode.

Deleting Selected Images

You can delete multiple images in the multi-image display at once.



Deleted images cannot be restored.



- Protected images cannot be deleted.
- You can select up to 100 images at a time.

1 Press the button.

The camera enters Playback mode and the single-image playback screen appears.

2 Turn the e-dial to the left (toward).

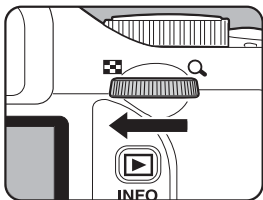

The multi-image display screen appears.



3 Press the button.

 appears on the images.

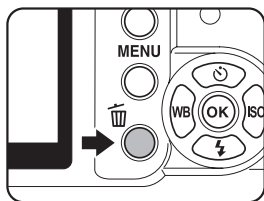

4 Use the four-way controller () to move to the images to delete and press the OK button.

The image is selected and  appears.

After selecting an image, turn the e-dial to change to single-image playback display and check the image.

Protected images cannot be selected.



5 Press the button.

The Delete confirmation screen appears.

6 Use the four-way controller () to select [Select&Delete].



7 Press the OK button.

The selected images are deleted.





Deleting a Folder

You can delete the selected folder and all the images in it.

- 1 In Playback mode, turn the e-dial 2 clicks to the left (toward ).**



The calendar/folder display screen appears.

When the calendar display screen appears, press the **INFO** button.

- 2 Press the four-way controller (   ) to select a folder to delete and press the  button.**

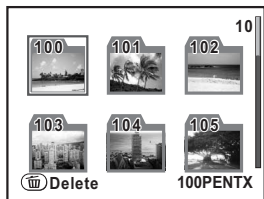
The delete folder confirmation screen appears.



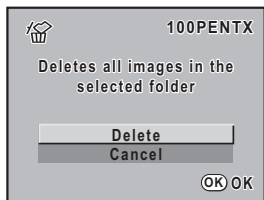

- 3 Use the four-way controller ( ) to select [Delete].**



- 4 Press the **OK** button.**

The folder and all images in the folder are deleted.

The confirmation screen appears when there are protected images. Use the four-way controller ( ) to select [Delete All] or [Leave All] and press the **OK** button.

When [Delete All] is selected, protected images are also deleted.



Deleting All Images

You can delete all saved images at once.



Deleted images cannot be restored.

- 1 Select **[Delete All]** in the **[▶ Playback 2]** menu.

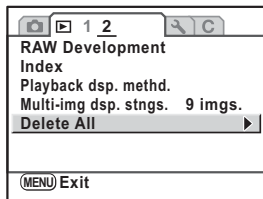

- 2 Press the four-way controller (▶).

- 3 Use the four-way controller (▲▼) to select **[Delete All]**.

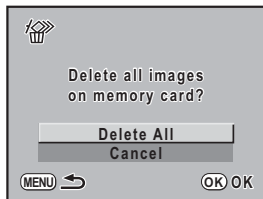

- 4 Press the **OK** button.

All images are deleted.

The confirmation screen appears when there are protected images. Use the four-way controller (▲▼) to select **[Delete All]** or **[Leave All]** and press the **OK** button.

When **[Delete All]** is selected, protected images are also deleted.



Protecting Images from Deletion (Protect)

You can protect images from being accidentally deleted.



Even protected images are deleted if the inserted SD Memory Card is formatted.

Protecting Single Images

- 1 Select [Protect] in the [▶ Playback 1] menu.

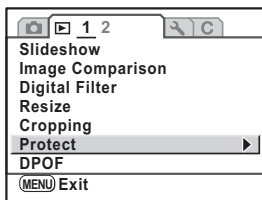

- 2 Press the four-way controller (▶).

- 3 Use the four-way controller (▲▼) to select [Single Image] and press the OK button.

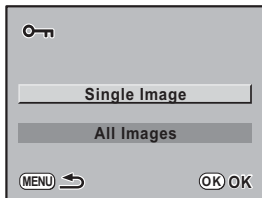

- 4 Use the four-way controller (◀▶) to select an image to protect.



5 Use the four-way controller (▲▼) to select [Protect].

Select [Unprotect] to cancel the Protect setting.

6 Press the OK button.

The image is protected and the  icon appears at the top right of the screen. (p.25)

Repeat Steps 4 to 6 to protect other images.

Protecting All Images

1 Select [All Images] in Step 3 of p.184 and press the OK button.

2 Press the four-way controller (▲▼) to select [Protect] and press the OK button.

All images saved in the SD Memory Card are protected.

Select [Unprotect] to cancel the protect setting on all of the images.



Connecting the Camera to AV Equipment

By using the video cable I-VC28 (optional), you can play back images using a TV or other device with a video IN jack as your monitor.

- 1 Turn the AV device and camera off.**
- 2 Open the terminal cover, face the arrow on the provided video cable toward the ▲ mark on the camera, and connect the video cable to the USB/Video terminal.**

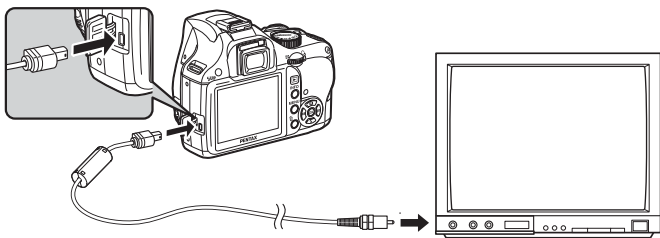

- 3 Connect the other end of the video cable to the video IN jack on the AV device.**
- 4 Turn the AV device and camera on.**



- If you intend to use the camera continuously for a long period, use of the AC adapter kit K-AC84 (optional) is recommended. (p.40)
- For AV equipment with multiple video IN jacks, check the operating manual of the AV device, and select the video IN jack to which the camera is connected.
- Depending on the country or region, images may fail to be played back if the video output format is set different from the one in use there. If this happens, change the video output format setting. (p.225)
- The camera monitor turns off while the camera is connected to the AV device.

8 Processing Images

This chapter describes how to process pictures taken and edit RAW images.

Changing the Image Size	188
Processing Images with Digital Filters	192
Editing RAW Images	195

You can reduce the size of an image by changing the number of recorded pixels and and/or quality level or cropping only part of the image.

Changing the Number of Recorded Pixels and Quality Level (Resize)

Changes the recorded pixels and quality level to create an image with a smaller file size.



- Only JPEG files captured with this camera can be resized.
- Larger numbers of recorded pixels and better quality levels than those of the original image cannot be selected.

- 1** Select [Resize] in the [▶] Playback 1] menu.

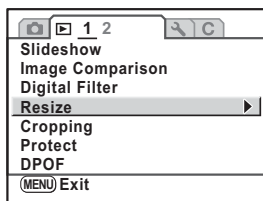

- 2** Press the four-way controller (▶).

- 3** Use the four-way controller (◀▶) to select an image to resize and press the OK button.

The screen to select the recorded pixels and quality level appears.



- 4** Use the four-way controller (▲▼) to select [JPEG Rec. Pixels] and the four-way controller (◀▶) to select a size.

You can select 10M, 6M, 2M or 640 (640×416).



- 5** Use the four-way controller (▲▼) to select [JPEG Quality] and the four-way controller (◀▶) to select a quality level.

You can select ★★★, ★★ or ★.

- 6** Press the OK button.

The save confirmation screen appears.

- 7** Use the four-way controller (▲▼) to select [Save as].

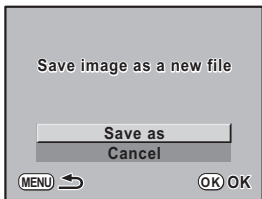

- 8** Press the OK button.

The resized image is saved as a new image.

Cutting Out Part of the Image (Cropping)

Cuts out only the desired area of the picture and saves it as a new image.



- Only JPEG files captured with this camera can be cropped.
- An area larger than the original image cannot be selected.

- 1** Select [Cropping] in the [▶ Playback 1] menu.

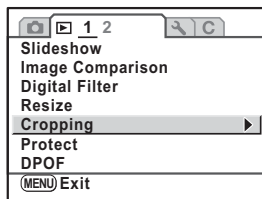

- 2** Press the four-way controller (▶).

- 3** Use the four-way controller (◀▶) to select an image to crop and press the OK button.

The screen to select the area to crop appears.



- 4** Select the size and position of the area to crop.

Use the following procedure to set the size and position of the area to crop.



e-dial	To set the size of the cropping area. Select from 9M (3680×2448), 8M (3456×2320), 7M (3264×2160), 6M (3008×2000), 4M (2464×1632), 2M (1824×1216) or 1M (1248×832).
Four-way controller (▲▼◀▶)	To move the cropping area.
INFO button	To change the orientation of the cropped area. Only available with such sizes where the cropped area can be rotated.

5 Press the **OK** button.

The save confirmation screen appears.

6 Use the four-way controller (▲▼) to select **[Save as]**.

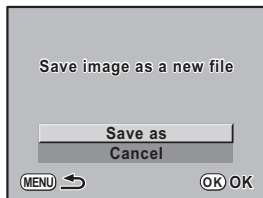

7 Press the **OK** button.

The cropped image is saved as a new image.

Processing Images with Digital Filters

You can edit captured images using digital filters. Processed image will be saved as a new image.

The following filters are available.

Filter name	Effect	Parameter
Toy Camera	For taking pictures that look as if taken with a toy camera.	Shading Level: +1/+2/+3
		Blurring: +1/+2/+3
		Tone Break: Red/Green/Blue
High Contrast	For taking pictures with high contrasts.	+1/+2/+3
Soft	For taking pictures with a soft focus throughout the image.	+1/+2/+3
Star Burst	For taking pictures of night scenes or lights reflected on water with a special sparkling look achieved by adding cross-like effects to the picture's highlights.	Number of light sources: Small/Medium/Large
		Size: Short/Medium/Long
		Angle: 0°/30°/45°/60°
Retro	For taking pictures with the look of old photos.	Blue/Amber: -2/-1/Off/+1/+2
		White frame: Thin/Medium/Thick
Extract color	For extracting a specific color and taking the rest of the picture in black and white.	Red/Magenta/Cyan/Blue/Green/Yellow
Illustration	Creates an image that looks as though it was painted or drawn with a crayon.	Pastel/Water Color
HDR	Creates an image that looks like a high dynamic range image.	Weak/Std./Strong
B&W	Converts to a black and white image.	B&W/Red/Green/Blue
Sepia	Adds a vintage touch to photos by converting them to sepia color.	Weak/Std./Strong
Color	Adds a color filter to the image.	Color: Red/Magenta/Cyan/Blue/Green/Yellow
		Color gradation: Pale/Std./Dark
Slim	Changes the horizontal and vertical ratio of images.	±8 levels

Filter name	Effect	Parameter
Brightness	Changes the brightness of images.	±8 levels
Custom	Customize and save a filter to your own preferences.	Color intensity: Off/+1/+2/+3
		Color: Red/Magenta/Cyan/Blue/Green/Yellow
		High Contrast: Off/+1/+2/+3
		Soft focus: Off/+1/+2/+3
		Outline highlight: -3 to +3
		Tone Break: Off/Red/Green/Blue
		Shading Level: -3 to +3
		Shading Type: 6 types



Only JPEG files and RAW files captured with this camera can be edited using the Digital Filters.

1 Select an image in Playback mode.

2 Select [Digital Filter] in the [▶ Playback 1] menu.

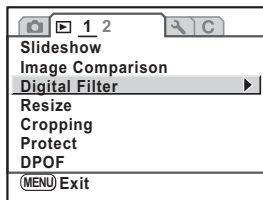

3 Press the four-way controller (▶).

The screen for selecting the filter appears.

4 Use the four-way controller (▲▼◀▶) to select a filter and press the OK button.

Select a filter and preview the effects on the screen.

You can turn the e-dial to select a different image.



5 Use the four-way controller (▲▼) to select the parameter and the four-way controller (◀▶) to adjust the value.

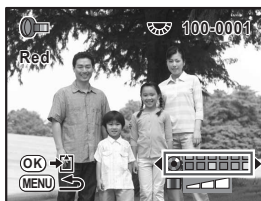

Color Filter



Slim Filter

6 Press the OK button.

The save confirmation screen appears.

7 Use the four-way controller (▲▼) to select [Uses filters in combination] or [Save as].

Select [Uses filters in combination] when you want to apply additional filters to the same image.

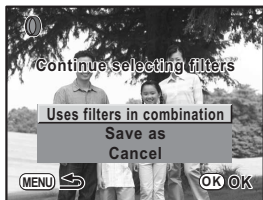

8 Press the OK button.

If [Uses filters in combination] was selected, the camera will return to Step 4.

If [Save as] was selected, the filter-processed image will be saved as a new image.



Up to 20 filters can be combined to the same image.

You can convert captured RAW files into JPEG files.



Only RAW files captured with this camera can be edited. RAW files and JPEG files captured with other cameras cannot be edited on this camera.

Editing a RAW Image

- 1 Select [RAW Development] in the [▶ Playback 2] menu.

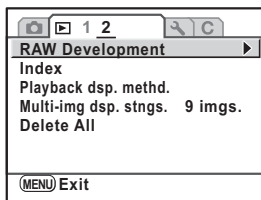

- 2 Press the four-way controller (▶).

- 3 Use the four-way controller (◀▶) to select an image to edit.

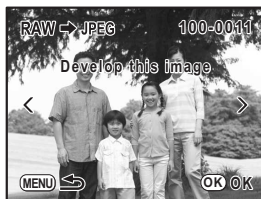

- 4 Press the OK button.

The parameters recorded in the image file appear.

To specify the parameters, see “Specifying the Parameters”.



5 Press the **OK** button.

The save confirmation screen appears.

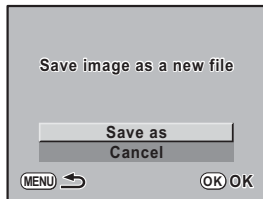
6 Use the four-way controller (**▲ ▼**) to select **[Save as]**.

7 Press the **OK** button.

The edited image is saved under a different name.

8 Use the four-way controller (**▲ ▼**) to select **[Exit]** and press the **OK** button.

Select **[Continue]** to edit other images.



Specifying the Parameters

Specifies the parameters for editing RAW images.
The following parameters can be changed.

Parameter	Value
Recorded Pixels	10M (3872×2592)/ 6M (3008×2000)/ 2M (1824×1216)
Quality Level	★★★ (Best)/★★ (Better)/★ (Good)
Custom Image	Bright/Natural/Portrait/Landscape/Vibrant/ Monochrome (p.157)
White Balance	AWB (Auto), ☀ (Daylight), ☷ (Shade), ☁ (Cloudy), ☀ D (Daylight colors fluorescent lights), ☀ N (Daylight white fluorescent lights), ☀ W (White light fluorescent lights), ☀ (Tungsten Light), ⚡ WB (Flash), 📷 (Manual) (p.159)
Sensitivity	-2.0 to +2.0
High-ISO Noise Reduction	Off/Weakest/Weak/Strong
Color Space	sRGB/AdobeRGB
Shadow Compensation	On/Off

- 1 Press the four-way controller (▲▼) in Step 4 of p.195 to choose the parameter you want to change.



- 2 Use the four-way controller (◀▶) to change the value.
- 3 Press the OK button.

The save confirmation screen appears.

4 Use the four-way controller (▲▼) to select [Save as] and press the OK button.

The RAW image is edited and saved as a new image.



When the white balance is set to [Manual], press the  **Av** button to display the measuring screen. Only the Spot measuring range is available.

9 Printing from the Camera

This chapter describes how to make the printing settings.

Setting the Printing Service (DPOF)	200
Printing Using PictBridge	203

Setting the Printing Service (DPOF)

You can order conventional photograph prints by taking the SD Memory Card with recorded images to a store for printing.

DPOF (Digital Print Order Format) settings allow you to specify the number of copies and to imprint the date.



- DPOF settings cannot be applied to RAW images.
- You can make DPOF settings for up to 999 images.

Printing Single Images

- 1 Select [DPOF] in the [▶ Playback 1] menu.

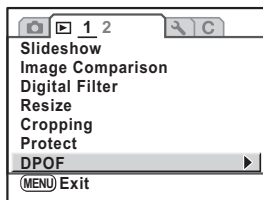

- 2 Press the four-way controller (▶).

- 3 Use the four-way controller (▲▼) to select [Single Image] and press the OK button.

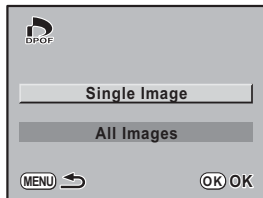

- 4** Use the four-way controller (◀▶) to select an image to set DPOF settings.

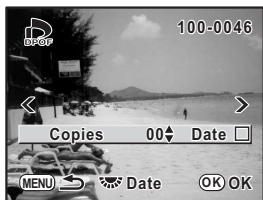

- 5** Use the four-way controller (▲▼) to select the number of copies.

You can set up to 99 copies.

- 6** Turn the e-dial to choose whether to insert the date () or not (.

: The date will be printed.

: The date will not be printed.

Repeat Steps 4 to 6 to set other images (up to 999).

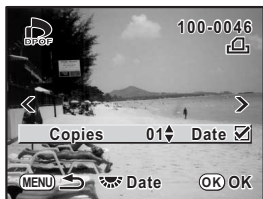

- 7** Press the OK button.

The DPOF setting for the selected image is saved and the camera returns to Playback mode.



Depending on the printer or printing equipment at the photo processing lab, the date may not be imprinted on the pictures even if the DPOF setting was made.



To cancel DPOF settings, set the number of copies to [00] in Step 5 and press the **OK** button.

Settings for All Images

1 Select [All Images] in Step 3 on p.200.

The screen for making DPOF settings for all images appears.

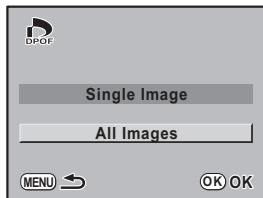

2 Choose the number of copies and whether to imprint the date or not.

Refer to Steps 5 and 6 of p.201 for details on how to make the settings.

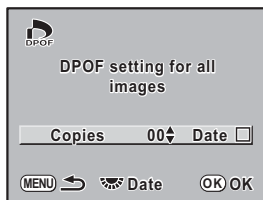

3 Press the OK button.

The DPOF settings for all images are saved and the camera returns to the screen that was displayed before selecting the menu.



The number of copies specified in settings for all images applies to all the images and the settings for single images are canceled. Before printing, check that the number is correct.

This function lets you print images directly from the camera without using a computer (direct printing).

Connect the camera to a PictBridge compatible printer with the included USB cable (I-USB7) to print directly.

Select the images you want to print, the number of copies and whether to insert the date or not on the camera after connecting to the printer.

Direct printing is performed in the following steps.

- 1 Set USB Connection on the camera to [PictBridge] (p.204)
- 2 Connect the camera to the printer (p.205)
- 3 Set the printing options
 - Print single images (p.206)
 - Print all images (p.208)
 - Print with DPOF settings (p.209)



- Use of the AC adapter kit K-AC84 (optional) is recommended when connecting the camera to a printer. The printer may not work properly or the image data may be lost if the battery set runs out of power while the camera is connected to the printer.
- Do not disconnect the USB cable during data transfer.
- Depending on the type of printer, not all the settings made on the camera (such as print settings and DPOF settings) may be valid.
- A printing error may occur if the selected number of copies exceeds 500.
- Printing an index of images, where multiple images appear on a single sheet, may not be possible unless the printer supports index printing. For index prints, you may need to use a computer.
- RAW images cannot be printed directly from the camera. Use [RAW Development] (p.195) to convert to a JPEG image or transfer to a computer and use PENTAX PHOTO Browser 3 to print RAW images.
- See the "PENTAX PHOTO Browser 3/PENTAX PHOTO Laboratory 3 Operating Manual" when connecting to a computer.

Setting USB Connection

1 Select [USB Connection] in the [**Set-up 2**] menu.

2 Press the four-way controller (**▶**).

A pop-up menu appears.

3 Use the four-way controller (**▲ ▼**) to select [PictBridge].

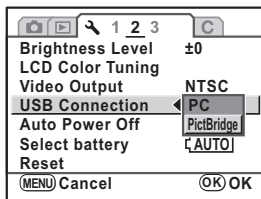

4 Press the **OK** button.

The setting is changed.

5 Press the **MENU** button.

The screen that was displayed before selecting the menu appears again.

Connecting the Camera to the Printer

- 1 Turn off the camera.
- 2 Open the terminal cover, face the arrow on the provided USB cable toward the ▲ mark on the camera, and connect the USB cable to the USB/Video terminal.

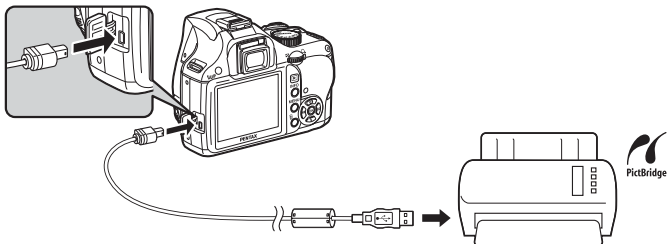

- 3 Connect the other end of the USB cable to a PictBridge-compatible printer.

The PictBridge logo is displayed on PictBridge compatible printers.

- 4 Turn the printer on.

- 5 After the printer start-up, turn the camera on.

The PictBridge menu appears.

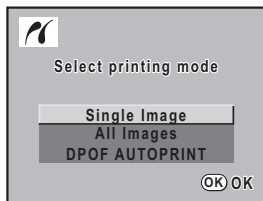

The PictBridge menu is not displayed if [USB Connection] is set to [PC].

Printing Single Images

- 1 Use the four-way controller (▲▼) to select [Single Image] in the PictBridge menu.

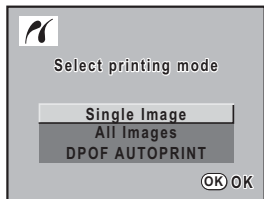

- 2 Press the OK button.
The print single image screen appears.

- 3 Use the four-way controller (◀▶) to choose an image to print.

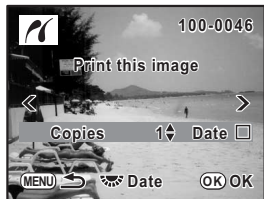

- 4 Use the four-way controller (▲▼) to choose the number of copies.

You can print up to 99 copies.

- 5 Turn the e-dial to choose whether to insert the date () or not () .

- : The date will be printed.
- : The date will not be printed.

- 6 Press the OK button.
The print settings confirmation screen appears.

Proceed to Step 11 to print the images using the default setting.

To change the print settings, go to Step 7.

- 7** Use the four-way controller (▲▼) to select [Paper Size] and press the four-way controller (▶).

The [Paper Size] screen appears.



- 8** Use the four-way controller (▲▼◀▶) to choose a paper size.

You can only choose a size that is supported by your printer.

When [Setting] is selected, images are printed according to the printer settings.

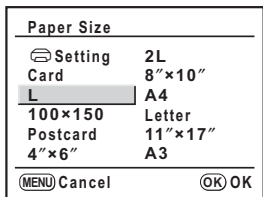

- 9** Press the OK button.

- 10** Repeat Steps 7 to 9 to set [Paper Type], [Quality] and [Border Status].

When [Setting] is selected for these print settings, images are printed according to the printer settings.

[Paper Type] with more ★s supports higher quality paper.

[Quality] with more ★s indicates higher print quality.

- 11** Use the four-way controller (▲▼) to select [Printing starts] and press the OK button.

The image is printed according to the settings.

Press the **MENU** button to cancel printing.

Printing All Images

- 1 Use the four-way controller (▲▼) to select [All Images] in the PictBridge menu.

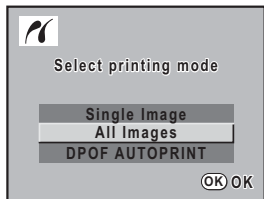

- 2 Press the OK button.

The print all images screen appears.

- 3 Choose the number of copies and whether to imprint the date or not.

The number of copies and the date setting that you choose apply to all of the images. Refer to Steps 4 and 5 of p.206 for details on how to make the settings.

Use the four-way controller (◀▶) to check the images set to be printed.



- 4 Press the OK button.

The print settings confirmation screen appears.

Refer to Steps 7 to 10 of p.207 for details on how to change the settings.

- 5 Use the four-way controller (▲▼) to select [Printing starts] and press the OK button.

All the images are printed according to the settings.

Press the **MENU** button to cancel printing.

Printing Images Using the DPOF Settings

- 1 Use the four-way controller (▲▼) to select [DPOF AUTOPRINT] in the PictBridge menu.

- 2 Press the OK button.

The print with DPOF settings screen appears.

Use the four-way controller (◀▶) to check the number of copies for each image, whether the date is imprinted or not, and total number of copies.

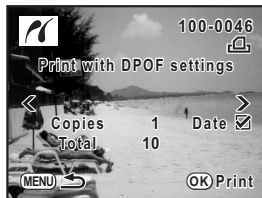

- 3 Press the OK button.

The print settings confirmation screen appears.

Refer to Steps 7 to 10 of p.207 for details on how to change the settings.

- 4 Use the four-way controller (▲▼) to select [Printing starts] and press the OK button.

The images are printed according to the settings.

Press the **MENU** button to cancel printing.

Disconnecting the USB Cable

Disconnect the USB cable from the camera and printer when you have finished printing.

- 1 Turn off the camera.

- 2 Disconnect the USB cable from the camera and printer.

Memo

10 Camera Settings

This chapter describes how to change the camera settings.

How to Operate the Set-up Menu	212
Formatting the SD Memory Card	214
Setting the Beep Setting, Date and Time, and Display Language	215
Adjusting the Monitor and the Menu Display	220
Setting the Folder Name/File Number Naming Convention	224
Selecting the Video Output Format and Power Settings	225
Using Pixel Mapping	228
Selecting Capture Mode Settings to Save in the Camera	229



Perform various settings related to the camera in the [ Set-up] menu.





For details on how to operate the menus, see "Using the Menus" (p.32).

Set-up Menu Setting Items

Perform the following settings in the [ Set-up 1-3] menu.

Press the **MENU** button in Capture/Playback mode and use the four-way controller ( ) to display the [ Set-up 1-3] menu.

Menu	Item	Function	Page
 1	Language/言語	Changes the language in which menus and messages appear.	p.219
	Date Adjust	Sets the date format and time.	p.216
	World Time	Sets display of local date and time of a specified city in addition to the present location on the monitor when traveling overseas.	p.216
	Text Size	Sets the size of the text selected in the menus.	p.220
	Guide display	Sets to display indicators in the monitor.	p.220
	Folder Name	Sets the method used to assign folder names for storing images.	p.224
	Beep	Switches the beep tone on/off.	p.215
 2	Brightness Level	Changes the brightness of the monitor.	p.221
	LCD Color Tuning	Adjusts the color of the monitor.	p.222
	Video Output	Sets the output format to the AV device.	p.225
	USB Connection	Sets the USB cable connection (computer or printer).	p.204
	Auto Power Off	Sets the time to turn off automatically.	p.225
	Select battery	Selects the type of batteries inserted in the camera.	p.226
	Reset	Resets all settings.	p.232

Menu	Item	Function	Page
3	Pixel Mapping	Maps out and corrects for any defective pixels in the CCD.	p.228
	Dust Alert	Detects dust adhering to the CCD.	p.244
	Dust Removal	Cleans the CCD by shaking it.	p.243
	Sensor Cleaning	Locks the mirror in the up position for cleaning the CCD.	p.246
	Format	Formats the SD Memory Card.	p.214

● [3 Set-up 1] menu

[3 1] 2 3	
Language/言語	English
Date Adjust	
World Time	⬆
Text Size	Std.
Guide display	3sec
Folder Name	Date
Beep	☑
(MENU) Exit	

● [3 Set-up 2] menu

[3 2] 3	
Brightness Level	±0
LCD Color Tuning	
Video Output	NTSC
USB Connection	PC
Auto Power Off	1min
Select battery	[AUTO]
Reset	
(MENU) Exit	

● [3 Set-up 3] menu

[3 3]	
Pixel Mapping	
Dust Alert	
Dust Removal	
Sensor Cleaning	
Format	
(MENU) Exit	

Formatting the SD Memory Card

Use this camera to format (initialize) an SD Memory Card that is unused or has been used on other cameras or digital devices. Formatting will delete all the data on the SD Memory Card.



- Do not remove the SD Memory Card while formatting. The card may be damaged beyond use.
- Formatting will delete all data, either protected or unprotected. Be aware.

1 Select **[Format]** in the **[Set-up 3]** menu.

2 Press the four-way controller (▶).

The **[Format]** screen appears.

3 Use the four-way controller (▲▼) to select **[Format]**.

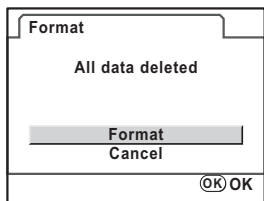

4 Press the **OK** button.

Formatting starts.

When formatting is completed, the screen that was displayed before selecting the menu appears again.

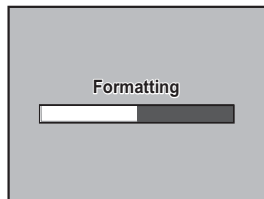

Turning the Beep On and Off

You can turn the camera operation beep on or off. The default setting is all (On).

There are five items that you can set: In-focus, AE-L (AE Lock button operation sound), RAW (RAW button operation sound), Self-timer and Remote Control.

1 Select [Beep] in the [Set-up 1] menu.

2 Press the four-way controller ().

The [Beep] screen appears.

3 Use the four-way controller () to select an item and the four-way controller () to select On () or Off () .

You can turn all the beeps off by selecting [Setting] and using the four-way controller () to select Off () .

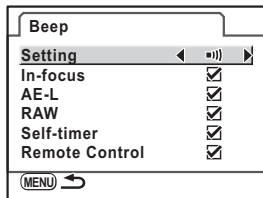

4 Press the MENU button twice.

The screen that was displayed before selecting the menu appears again.

Changing the Date and Time and the Display Style

You can change the initial date and time settings. You can also set the display style. Choose [mm/dd/yy], [dd/mm/yy] or [yy/mm/dd]. Choose [12h] (12 hour) or [24h] (24 hour) for time display method.

Set in [Date Adjust] in the [↖ Set-up 1] menu (p.212).

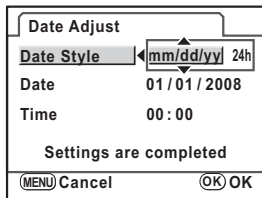

☞ Setting the Date and Time (p.54)

Setting the World Time

The date and time selected in "Initial Settings" (p.50) serve as the date and time of your present location.

Setting the destination in [World Time] enables you to display the local date and time on the monitor when traveling overseas.

1 Select [World Time] in the [↖ Set-up 1] menu.

2 Press the four-way controller (▶).

The [World Time] screen appears.

3 Use the four-way controller (◀▶) to select → (Destination) or ↶ (Hometown).

This setting changes the date and time on the guide display screen.

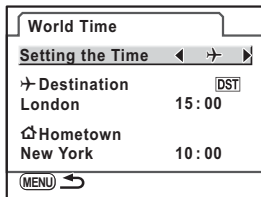

4 Press the four-way controller (▼).

The selection frame moves to ➔ (Destination setting).

5 Press the four-way controller (▶).

The screen for setting the Destination city appears.

6 Use the four-way controller (◀▶) to select a destination city.

Turn the e-dial to change the region.

The current time, location and time difference of the selected city appears.

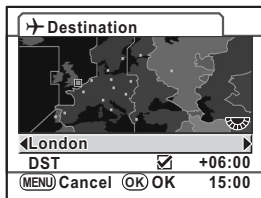

7 Use the four-way controller (▼) to select [DST].

8 Use the four-way controller (◀▶) to select (On) or (Off).

Select (On) if the destination city uses daylight saving time (DST).

9 Press the OK button.

The destination setting is saved.

10 Press the MENU button twice.

The screen that was displayed before selecting the menu appears again.



- See "List of World Time Cities" (p.218) for cities that can be specified as a destination.
- Select 🏠 (Hometown setting) in Step 4 to set the city and DST setting.
- ➔ appears in the guide display and status screen if World Time is set to ➔ (Destination). (p.22)
- When you switch World Time to ➔ (Destination), the video output (p.225) setting changes to the default setting for that city.

List of World Time Cities

Region	City	Region	City
North America	Honolulu	Africa/ West Asia	Dakar
	Anchorage		Algiers
	Vancouver		Johannesburg
	San Francisco		Istanbul
	Los Angeles		Cairo
	Calgary		Jerusalem
	Denver		Nairobi
	Chicago		Jeddah
	Miami		Tehran
	Toronto		Dubai
	New York		Karachi
	Halifax		Kabul
	Central and South America		Mexico City
Lima		Delhi	
Santiago		Colombo	
Caracas		Kathmandu	
Buenos Aires		Dacca	
Sao Paulo			
Rio de Janeiro	East Asia	Yangon	
Europe		Lisbon	Bangkok
		Madrid	Kuala Lumpur
		London	Vientiane
		Paris	Singapore
		Amsterdam	Phnom Penh
		Milan	Ho chi Minh
		Rome	Jakarta
		Copenhagen	Hong Kong
		Berlin	Beijing
		Prague	Shanghai
		Stockholm	Manila
		Budapest	Taipei
		Warsaw	Seoul
		Athens	Tokyo
	Helsinki	Guam	
	Moscow		

Region	City
Oceania	Perth
	Adelaide
	Sydney
	Noumea
	Wellington
	Auckland
	Pago Pago

Setting the Display Language

You can change the language in which the menus, error messages, etc. are displayed.

You can choose from 19 languages: English, French, German, Spanish, Portuguese, Italian, Dutch, Danish, Swedish, Finnish, Polish, Czech, Hungarian, Turkish, Greek, Russian, Korean, Chinese (Traditional/Simplified) and Japanese.

Set in [Language/言語] in the [ Set-up 1] menu (p.212).



 Setting the Display Language (p.50)

Adjusting the Monitor and the Menu Display

Setting the Text Size

You can set the size of the text selected in the menus to [Std.] (normal display) or [Large] (magnified display).

Set in [Text Size] in the [Set-up 1] menu (p.212).

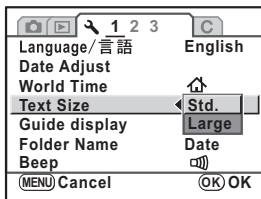

Setting the Guide Display Time

Set the length of time that the guides are displayed on the monitor when the camera is turned on or the Capture mode is changed. (p.22)

Select from [Off], [3 sec], [10 sec] and [30 sec]. The default setting is [3 sec].

Set in [Guide display] in the [Set-up 1] menu (p.212).

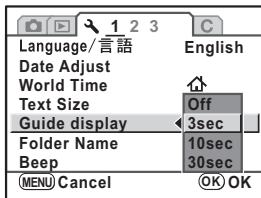

Setting the Status Display

Sets whether the status screen will always appear on the monitor. The default setting is [On].

Set in [21. Display status] in the [C Custom Setting 3] menu (p.78).

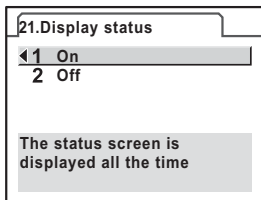

Adjusting the Brightness of the Monitor

You can adjust the brightness of the monitor. Adjust settings when the monitor is hard to see.

Set in [Brightness Level] in the [F Set-up 2] menu (p.212).

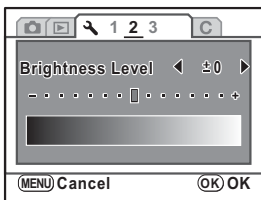

Adjusting the Color of the Monitor

You can adjust the color of the monitor.

1 Select [LCD Color Tuning] in the [Set-up 2] menu.

2 Press the four-way controller ().

The [LCD Color Tuning] screen appears.

3 Use the four-way controller () to adjust the color.

You can adjust the value from the 15 levels.

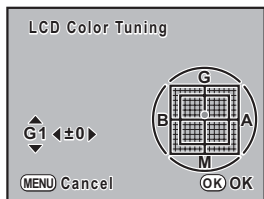

G-M	Adjusts the tone of the colors between green and magenta.	
B-A	Adjusts the tone of the colors between blue and amber.	

4 Press the OK button.

5 Press the MENU button.

The screen that was displayed before selecting the menu appears again.

Setting the Display for Instant Review

You can set the Instant Review display time and whether or not to display the histogram and Bright/Dark area warning. The default settings are [1 sec] for the display time and [Off] for the histogram and Bright/Dark area warning.

1 Select [Instant Review] in the [Rec. Mode 2] menu.

- 2** Press the four-way controller (▶).

The [Instant Review] screen appears.

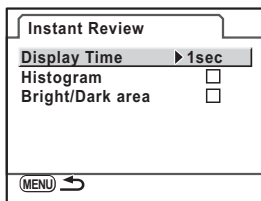

- 3** Press the four-way controller (▶) and use the four-way controller (▲▼) to select a display time, and then press the OK button.

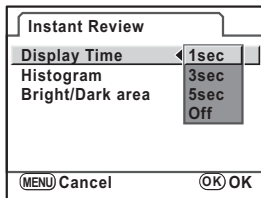

- 4** Use the four-way controller (▲▼) to select [Histogram].

- 5** Use the four-way controller (◀▶) to select (On) or (Off).

- 6** Use the four-way controller (▲▼) to select [Bright/Dark area].

- 7** Use the four-way controller (◀▶) to select (On) or (Off).

- 8** Press the **MENU** button twice.

The screen that was displayed before selecting the menu appears again.

Setting the Folder Name/File Number Naming Convention

Selecting the Folder Name

You can select a method for assigning the folder names for storing images. The default setting is [Date].

Date	The two digits of the [month] and [day] on which the picture was taken are assigned as the folder name in the form of [xxx_MMDD]. [xxx] is a sequential number from 100 to 999. [MMDD] (month and day) appears according to the display style set in [Date Adjust] (p.216). (Example) 101_0125: for folders with pictures taken on January 25th
PENTX	The folder name is assigned in the form of [xxxPENTX]. (Example) 101PENTX

Set in [Folder Name] in the [Set-up 1] menu (p.212).

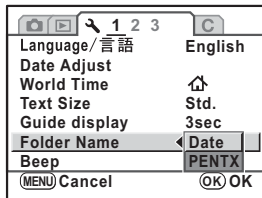

Selecting the File Number Setting

You can select a method for assigning the file number of an image when saved to a new folder. Select (On) or (Off) for [File No.] in [Memory] (p.229) in the [Rec. Mode 3] menu.

<input checked="" type="checkbox"/> (On)	The file number of the last image saved to the previous folder is saved and subsequent images are assigned sequential file numbers even if a new folder is created.
<input type="checkbox"/> (Off)	The file number of the first image saved to a folder returns to 0001 each time a new folder is created for saving images.



When the number of storable images exceeds 500, captured images are divided into folders of 500 images each. However, in Auto Bracket shooting, images will be stored in the same folder until shooting is completed, even if the number of images exceeds 500.

Selecting the Video Output Format

When you connect the camera to AV equipment such as a TV, choose an appropriate video output format (NTSC or PAL) for playing back images.

Set in [Video Output] in the [Set-up 2] menu (p.212).

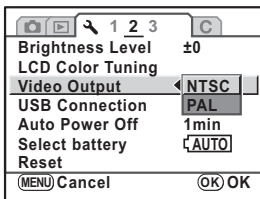

Connecting the Camera to AV Equipment (p.186)



The default video output format differs depending on the region. When you switch the World Time to (Destination), the video output setting changes to the default setting for that city.

Setting Auto Power Off

You can set the camera to turn off automatically if unused after a certain length of time. Select from [1 min], [3 min], [5 min], [10 min], [30 min] or [Off]. The default setting is [1 min].

Set in [Auto Power Off] in the [Set-up 2] menu (p.212).

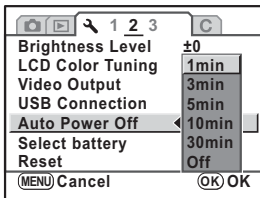



Auto Power Off will not work during slideshow playback or USB connection.

Setting the Battery Type

Sets the type of batteries used in the camera. The default setting is [Auto-detect].

1 Select [Select battery] in the [**Set-up 2**] menu.

2 Press the four-way controller (**▶**).

The [Select battery] screen appears.

3 Use the four-way controller (**▲▼**) to select the type of battery.

When set to [Auto-detect], the camera will detect automatically the type of battery used.

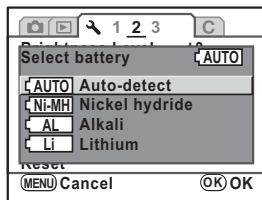

4 Press the **OK** button.

5 Press the **MENU** button twice.

The screen that was displayed before selecting the menu appears again.



When a type of battery different from that selected in the menu setting is used, the battery level will not be correctly determined. Please set the correct battery type. Usually, there is no problem using automatic detection. However in low temperatures and when using batteries that were stored for long periods of time, set the appropriate battery type so the camera can correctly determine the remaining battery level.

Setting the Operation of the Power Lamp

Sets the operation of the power lamp from [Std.], [Weak] or [Off].
The default setting is [Std.].

Set in [20. Power lamp] setting in the [**C** Custom Setting 3] menu (p.78).

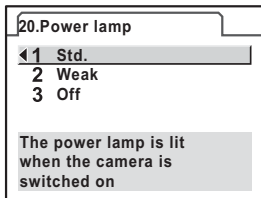

Even if the power lamp is set to [Off], the lamp lights up while the camera is transferring data to a computer or printer connected using the USB cable.

Using Pixel Mapping

Pixel mapping is a function for mapping out and correcting for defective pixels in the CCD.

1 Select **[Pixel Mapping]** in the **[↶ Set-up 3]** menu.

2 Press the four-way controller (▶).

The **[Pixel Mapping]** screen appears.

3 Press the four-way controller (▲▼) to select **[Pixel Mapping]** and press the **OK** button.

Defective pixels are mapped and corrected, and the screen that was displayed before selecting the menu appears again.

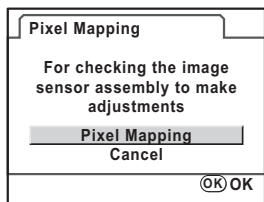

When the battery level is low, **[Not enough battery remaining to activate Pixel Mapping]** is displayed on the monitor. Use the AC adapter kit K-AC84 (optional) or use batteries with ample power remaining.

Selecting Capture Mode Settings to Save in the Camera

You can select which settings to save when the camera is turned off. The following settings can be saved: Flash Mode, Drive Mode, White Balance, Sensitivity, EV Compensation, Flash Exp. Comp., Playback Display and File No. The default setting is (On) for all settings.

1 Select [Memory] in the [Rec. Mode 3] menu.

2 Press the four-way controller (▶).

The [Memory] screen appears.

3 Use the four-way controller (▲▼) to choose an item.

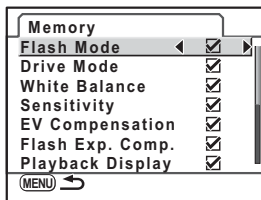

4 Use the four-way controller (◀▶) to select (On) or (Off).

5 Press the **MENU** button twice.

The screen that was displayed before selecting the menu appears again.



Set [File No.] to (On) to continue the sequential numbering for the file name even if a new folder is created. See “Selecting the File Number Setting” (p.224).

Memo

11 Resetting to Default Settings

Resets the camera settings.

Resetting Rec. Mode/Playback/Set-up Menu ... 232

Resetting the Custom Menu 233

Resetting Rec. Mode/Playback/Set-up Menu

Settings in [📷 Rec. Mode] menus, [▶ Playback] menus and [🔧 Set-up] menus can be reset to default settings.



Language/言語, Date Adjust, World Time city, Text Size, Video Output and [C Custom Setting] menu settings are not reset.

1 Select [Reset] in the [🔧 Set-up 2] menu.

2 Press the four-way controller (▶).

The [Reset] screen appears.

3 Use the four-way controller (▲▼) to select [Reset].

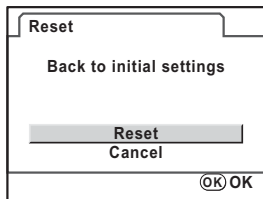

4 Press the OK button.

The settings are reset, and the screen that was displayed before selecting the menu appears again.

Reset settings in [C Custom Setting] menu to default settings.

1 Select [Reset Custom function] in the [C Custom Setting 4] menu.

2 Press the four-way controller (▶).

The [Reset Custom function] screen appears.

3 Use the four-way controller (▲ ▼) to select [Reset].

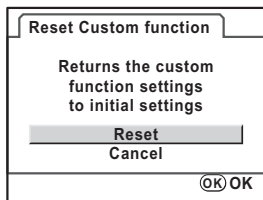

4 Press the OK button.

The settings are reset, and the screen that was displayed before selecting the menu appears again.

Memo

12 Appendix

Default Settings	236
Functions Available with Various Lens Combinations	240
Cleaning the CCD	243
Optional Accessories	248
Error Messages	252
Troubleshooting	255
Main Specifications	258
Glossary	262
Index	267
WARRANTY POLICY	272

The table below shows the factory default settings.

The current setting (last memory) is saved when the camera is turned off.

Reset Setting



Yes : The setting returns to the default setting with the reset function (p.231).

No : The setting is saved even after reset.

Direct Keys

Item	Default Setting	Reset Setting	Page
Drive Mode	<input type="checkbox"/> (Single frame shooting)	Yes	p.106 p.125 p.128 p.130
Flash Mode	Depends on Capture mode	Yes	p.65
White Balance	AWB (Auto)	Yes	p.159
Sensitivity	AUTO (ISO 100 - 800)	Yes	p.87

[Rec. Mode] Menu

Item	Default Setting	Reset Setting	Page
Custom Image	Bright	Yes	p.157
Digital Filter	Not use any filters	Yes	p.132
File Format	JPEG	Yes	p.152
JPEG Recorded Pixels	 (3872×2592)	Yes	p.150
JPEG Quality	★★★ (Best)	Yes	p.151
RAW file format	PEF	Yes	p.153
Color Space	sRGB	Yes	p.164
AF Mode	AFA	Yes	p.111
AE Metering	 (Multi-segment)	Yes	p.101
Select AF point	 (Wide)	Yes	p.113

Item		Default Setting	Reset Setting	Page	
Instant Review	Display Time	1 sec	Yes	p.222	
	Histogram	<input type="checkbox"/> (Off)	Yes		
	Bright/Dark area	<input type="checkbox"/> (Off)	Yes		
Memory		All <input checked="" type="checkbox"/> (On)	Yes	p.229	
Help button	(Select function)		Help function	Yes	p.154
	Digital Preview	Histogram	<input type="checkbox"/> (Off)	Yes	
		Bright/Dark area	<input type="checkbox"/> (Off)	Yes	
	RAW button function	Cancel each time	<input checked="" type="checkbox"/> (On)	Yes	
		JPEG/RAW/RAW+ File Format	All RAW+	Yes	
Shake Reduction		<input checked="" type="checkbox"/> (On)	Yes	p.122	
Input Focal Length		35	Yes	p.124	

[▶] Playback] Menu

Item		Default Setting	Reset Setting	Page
Slideshow	Interval	3 sec	Yes	p.177
	Screen effect	Off	Yes	
	Repeat Playback	<input type="checkbox"/> (Off)	Yes	
Image Comparison		—	—	p.176
Digital Filter*		B&W	Yes	p.192
Resize		Maximum size according to the setting	—	p.188
Cropping		Maximum size according to the setting	—	p.190
Protect		—	No	p.184
DPOF		—	No	p.200
RAW Development		Recorded Pixels: 10M Quality Level: ★★★ Sensitivity: ±0	Yes	p.195
Index		—	—	p.172

Item		Default Setting	Reset Setting	Page
Playback dsp. methd.	Bright/Dark area	<input type="checkbox"/> (Off)	Yes	p.168
	Quick Zoom	<input type="checkbox"/> (Off)	Yes	
Multi-img dsp. stngs.		9 imgs.	Yes	p.170
Delete All		—	—	p.183

* The filter parameter settings can be saved or reset.

[Set-up] Menu

Item		Default Setting	Reset Setting	Page
Language/言語		According to default setting	No	p.219
Date Adjust		According to default setting	No	p.216
World Time	World Time setting	 (Hometown)	Yes	p.216
	Hometown (City)	According to default setting	No	
	Hometown (DST)	According to default setting	No	
	Destination (City)	Same as Hometown	No	
	Destination (DST)	Same as Hometown	No	
Text Size		According to default setting	No	p.220
Guide display		3 sec	Yes	p.220
Folder Name		Date	Yes	p.224
Beep		All <input checked="" type="checkbox"/> (On)	Yes	p.215
Brightness Level		±0	Yes	p.221
LCD Color Tuning		±0	Yes	p.222
Video Output		According to default setting	No	p.225
USB Connection		PC	Yes	p.204
Auto Power Off		1 min	Yes	p.225
Select battery		Auto-detect	Yes	p.226
Reset		—	—	p.232
Pixel Mapping		—	—	p.228
Dust Alert		—	—	p.244

Item		Default Setting	Reset Setting	Page
Dust Removal	Dust Removal	—	—	p.243
	Start-up action	<input type="checkbox"/> (Off)	Yes	
Sensor Cleaning		—	—	p.246
Format		—	—	p.214

[C Custom Setting] Menu

Item	Default Setting	Reset Setting	Page
1. EV Steps	1/2 EV Steps	Yes	p.105
2. Sensitivity Steps	1 EV Steps	Yes	p.87
3. Meter Operating Time	10 sec	Yes	p.103
4. AE-L with AF locked	Off	Yes	p.115
5. Link AF Point and AE	Off	Yes	p.103
6. Auto Bracketing order	0 - +	Yes	p.106
7. Shadow Compensation	On	Yes	—
8. Adjust White Balance	Off	Yes	p.162
9. AF Button function	Enable AF1	Yes	p.105 p.110
10. AF in remote control	Off	Yes	p.129
11. Slow Shutter Speed NR	On	Yes	p.89
12. High-ISO Noise Reduction	Off	Yes	p.89
13. e-dial in Program	Off	Yes	p.92
14. Release when Charging	Off	Yes	p.71
15. Flash in Wireless Mode	On	Yes	p.144
16. WB when using flash	Flash	Yes	p.160
17. Display Sensitivity	Off	Yes	—
18. Catch-in focus	Off	Yes	p.118
19. Using aperture ring	Prohibited	Yes	p.241
20. Power lamp	Std.	Yes	p.227
21. Display status	On	Yes	p.221
Reset Custom function	—	—	p.233

Functions Available with Various Lens Combinations

Lenses that can be used with this camera

Only DA, DA L and FA J lenses and D FA/FA/F/A lenses having an **A** (Auto) position on the aperture ring can be used with factory default settings. Refer to “Notes on [19. Using Aperture Ring]” (p.241) for other lenses and D FA/FA/F/A lenses with aperture ring set to a position other than **A**.

Yes : Functions are available when the aperture ring is set to the **A** position.

No : Functions are unavailable.

Function \ Lens [Mount type]	DA/DA L/D FA/FA J/FA lens [KAF, KAF2] ^{*4}	F lens [KAF] ^{*4}	A lens [KA]
Autofocus (Lens only) (With AF adapter 1.7×) ^{*1}	Yes —	Yes —	— Yes ^{*5}
Manual focus (With the focus indicator) ^{*2} (With Matte field)	Yes Yes	Yes Yes	Yes Yes
Five AF points	Yes	Yes	No ^{*5}
Power zoom	No	—	—
Aperture Priority Automatic Exposure	Yes	Yes	Yes
Shutter Priority Automatic Exposure	Yes	Yes	Yes
Manual Exposure	Yes	Yes	Yes
P-TTL Auto Flash ^{*3}	Yes	Yes	Yes
Multi (16-segment) metering	Yes	Yes	Yes
Automatic lens focal length acquirement when using the Shake Reduction function	Yes	Yes	No

^{*1} Lenses with a maximum aperture of f/2.8 or brighter. Only available at **A** position.

^{*2} Lenses with a maximum aperture of f/5.6 or brighter.

^{*3} When using the built-in flash and AF540FGZ, AF360FGZ, AF200FG or AF160FC.

^{*4} To use an F/FA soft 85 mm f/2.8 lens or FA soft 28 mm f/2.8 lens, set [19. Using aperture ring] to [Permitted] in the [C Custom Setting 3] menu. Pictures can be taken with the aperture you set, but only within manual aperture range.

^{*5} The AF point becomes  (Center).

Lens names and mount names

DA lenses with an ultrasonic motor and FA zoom lenses with power zoom use the KAF₂ mount.

DA lenses with ultrasonic motor and no AF coupler use the KAF₃ mount. FA prime lenses (non-zoom lenses), DA or DA L lenses without ultrasonic motors and D FA, FA J and F lenses use the KAF mount.

See the lens manual for details. Note that this camera is not equipped with a power zoom function.

Lenses and accessories that cannot be used with this camera

When aperture ring is set at other than the **A** (Auto) position or a lens without an **A** position or accessories such as an auto extension tube or auto bellows are used, the camera does not operate unless [19. Using aperture ring] is set to [Permitted] in the [**C** Custom Setting 3] menu. Refer to “Notes on [19. Using Aperture Ring]” (p.241) for restriction that apply. All camera exposure modes are available when using DA/DA L/FA J or lenses with an Aperture **A** position set to the **A** position.

Lens and Built-in Flash

The built-in flash cannot be regulated and fully discharges when A lenses not set to the **A** (Auto) position, pre A lenses or soft focus lenses are used. Note that the built-in flash cannot be used as an Auto Flash.

Notes on [19. Using Aperture Ring]

When [19. Using aperture ring] is set to [Permitted] in [**C** Custom Setting 3] menu, the shutter can be released even if the aperture ring of the D FA, FA, F or A lens is not set to the **A** (Auto) position or a lens without an **A** position is attached. However, the features will be restricted as shown below.

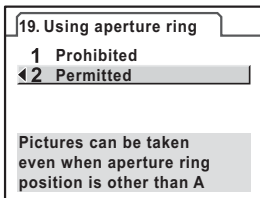

Restrictions on using lenses with aperture ring set to a position other than **A**

Lens Used	Exposure Mode	Restriction
D FA, FA, F, A, M (lens only or with auto diaphragm accessories such as auto extension tube K)	Av (Aperture Priority) mode	The aperture remains open regardless of the aperture ring position. The shutter speed changes in relation to the open aperture but an exposure error may occur. In the viewfinder, [F--] appears for the aperture indicator.
D FA, FA, F, A, M, S (with diaphragm accessories such as extension tube K)	Av (Aperture Priority) mode	Pictures can be taken with the specified aperture value but an exposure error may occur. In the viewfinder, [F--] appears for the aperture indicator.
Manual diaphragm lens such as reflex lens (lens only)	Av (Aperture Priority) mode	
FA, F soft 85mm FA soft 28mm (lens only)	Av (Aperture Priority) mode	Pictures can be taken with the specified aperture value in the manual aperture range. In the viewfinder, [F--] appears for the aperture indicator.
All lenses	M (Manual) mode	Pictures can be taken with the set aperture value and shutter speed. In the viewfinder, [F--] appears for the aperture indicator. When the  Av button is pressed, stop-down metering is performed and the shutter speed is set for the appropriate exposure for the aperture value set manually.



The camera operates in **Av** (Aperture Priority) mode regardless of the mode dial setting other than **M** (Manual) mode when the aperture is set to a value other than the **A** position.

Shadows may appear in the image on white backgrounds and other shooting conditions if the CCD becomes dirty or dusty. This indicates that the CCD must be cleaned.

Removing Dust by Shaking the CCD (Dust Removal)

The Dust Removal function shakes the CCD to remove dust that has collected.

1 Select [Dust Removal] in the [**Set-up 3**] menu.

2 Press the four-way controller (▶).

The [Dust Removal] screen appears.

3 Press the OK button.

The Dust Removal function is activated by shaking the CCD.

Select [Start-up action] and use the four-way controller (◀▶) to select (On) to turn Dust Removal on every time the camera is turned on.

When Dust Removal is completed, the camera returns to the [**Set-up 3**] menu.

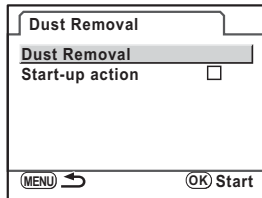

Detecting Dust on the CCD (Dust Alert)

Dust Alert is the function that detects dust adhering to the CCD and visually displays the location of the dust.

You can save the detected image and display it when performing sensor cleaning (p.246).

The following conditions must be met before using the Dust Alert function:

- A DA, DA L, FA J lens or a D FA, FA and F lens that has an Aperture **A** (Auto) position is attached.
- The aperture is set to the **A** position when using a lens with an aperture ring.
- The focus mode lever is set to **AF**.

1 Select [Dust Alert] in the [Set-up 3] menu.

2 Press the four-way controller ().

The [Dust Alert] screen appears.

3 Fully display a white wall or uniformly bright subject in the viewfinder and press the shutter release button fully.

After image processing is performed, the Dust Alert image appears.

If [NG] is displayed, press the **OK** button and take another picture.

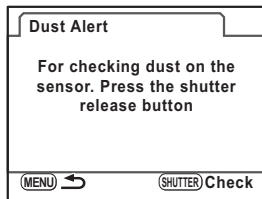

4 Press the **OK** button.

The image is saved and the camera return to the [Set-up 3] menu.

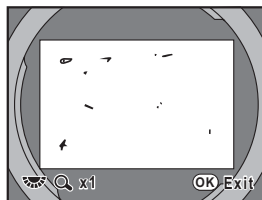



- The exposure time may be extremely long when using the Dust Alert function. Note that if the direction of the lens is changed before processing is complete, dust will not be detected properly.
- Depending on the subject conditions or temperature, dust may not be detected properly.
- The Dust Alert image will be deleted after 30 minutes from the time the image is saved. If 30 minutes elapse, save a new Dust Alert image and then perform sensor cleaning.
- The saved Dust Alert image cannot be displayed in Playback mode.
- Dust Alert image cannot be saved when an SD Memory Card is not inserted.



- Regardless of the camera settings, Dust Alert image will be taken with specific shooting conditions.
- Press the **INFO** button or turn the e-dial when displaying the Dust Alert image to view it at full screen display.

Removing Dust with a Blower

Raise the mirror up and open the shutter to clean with a blower. Please contact PENTAX Service Center for professional cleaning because the CCD is a precision part. Cleaning services involve a fee. You can use the Imagesensor Cleaning Kit O-ICK1 (optional) when cleaning the CCD.



- Do not use a spray type blower.
- Do not clean the sensor when the shutter speed is set to **Bulb**.
- Always cap the lens mount area to prevent dirt and dust from accumulating on the CCD when no lens is on the camera.
- When the battery level is low, [Not enough battery remaining to clean sensor] is displayed on the monitor.
- It is recommended to use the AC adapter kit K-AC84 (optional) when cleaning the sensor. If you are not using the AC adapter kit K-AC84 (optional), please use batteries with ample capacity remaining. If the battery capacity becomes low during cleaning, a warning beep will sound. Please stop cleaning immediately.
- Do not put the tip of the blower inside the lens mount area. If the power is turned off, this could cause damage to the shutter, CCD or the mirror.



- The self-timer lamp blinks while cleaning the sensor.
- This camera features a CCD shifting shake reduction system, and it may generate a vibration sound while cleaning the CCD. It is not a malfunction.

- 1 Turn the camera off and remove the lens.**
- 2 Turn the camera on.**
- 3 Select [Sensor Cleaning] in the [↖ Set-up 3] menu.**

4 Press the four-way controller (▶).

The [Sensor Cleaning] screen appears.

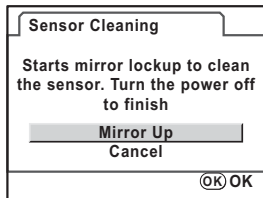
5 Use the four-way controller (▲▼) to select [Mirror Up].

6 Press the OK button.

The mirror is locked in the up position.

If you used Dust Alert to detect dust on the sensor within the last 30 minutes, the Dust Alert image appears on the monitor. Clean the sensor while checking the location of the dust.

7 Clean the CCD.

Use a brush-less blower to remove dirt and dust from the CCD. Using a blower with a brush may scratch the CCD. Do not wipe the CCD with a cloth.

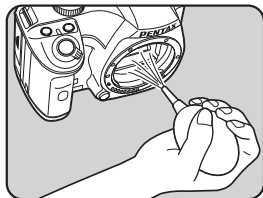

8 Turn off the camera.

9 Attach the lens after the mirror returns to its original position.

A number of dedicated accessories are available for this camera. Please contact a PENTAX Service Center for details regarding accessories. Products marked with an asterisk (*) are the same as those supplied with the camera.

Power Supply Accessories

AC Adapter kit K-AC84

(Set includes AC ADAPTER D-AC76, DC COUPLER D-DC84 and AC plug cord(*).)

Lets you power your camera with the outlet when combined with the AC plug cord.

Flash Accessories

Auto Flash AF540FGZ

Auto Flash AF360FGZ

The AF540FGZ and AF360FGZ are P-TTL auto flash units with a maximum guide number of 54 and 36 (ISO 100/m), respectively. Their features include slave-sync flash, contrast-control-sync flash, auto flash, high-speed sync flash, wireless flash, slow-speed sync and trailing curtain sync flash.



AF540FGZ



AF360FGZ

Auto Flash AF200FG

The AF200FG is a P-TTL auto flash unit with a maximum guide number of 20 (ISO 100/m). It features contrast-control-sync flash and slow-speed sync flash when combined with the AF540FGZ or AF360FGZ unit.



AF200FG

Auto Macro Flash AF160FC

The AF160FC is a flash system especially designed for macro photography to take close, shadowless pictures of small objects. It is compatible with existing TTL auto flash functions and it can be used with a wide range of PENTAX cameras by using the provided adapter ring.



AF160FC

Hot Shoe Adapter F₆

Extension Cord F5P



Hot Shoe Adapter F₆

Off-Camera Shoe Adapter F

Use the adapters and cords to use the external flash away from the camera.



Off-camera Shoe Adapter F

Off-camera Shoe Clip CL-10

When using the AF540FGZ or AF360FGZ as a wireless flash, this large clip is used for setting the external flash on a desk or table.



Off-camera Shoe Clip CL-10

For Viewfinder

Magnifier Fb

This viewfinder accessory is for magnifying the central area of the viewfinder 2 \times .

You can see the entire view by simply flipping up the accessory from the eyepiece, as it is a hinge-type magnifier.



Magnifier Fb

Ref-converter A

This is an accessory that changes the viewfinder viewing angle at 90° intervals. The viewfinder magnification can be switched between 1 \times and 2 \times .



Ref-converter A

Diopter correction lens adapter M

This accessory adjusts the diopter. Install it on the viewfinder.

If it is difficult to see the viewfinder image clearly, choose one of the eight correction of approximately -5 to $+3$ m $^{-1}$ (per meter).



Diopter correction lens adapter M

Eyecup Fc (*)

Remote Control F

Lets you shoot pictures from within 5 m of the front of the camera.



Camera Case/Strap

Camera Case O-CC84

Camera Strap O-ST84 (*)

Imagesensor Cleaning Kit O-ICK1

Clean the optical parts such as the CCD and lens of this camera.



Others

Body Mount Cap K

Hot Shoe Cover Fk (*)

USB Cable I-USB7 (*)

Video Cable I-VC28



























Error Message	Description
Memory card full	The SD Memory Card is full and no more images can be saved. Insert a new SD Memory Card or delete unwanted images. (p.42, p.73) Data may be saved when you perform the following operations. <ul style="list-style-type: none"> • Change the file format to JPEG. (p.150) • Change the JPEG Recorded Pixels or JPEG Quality setting. (p.151)
No image	There are no images for playback on the SD Memory Card.
This image cannot be displayed	You are trying to play back an image in a format not supported by this camera. You may be able to play it back on another brand of camera or your computer.
No card in the camera	The SD Memory Card is not inserted in the camera. (p.42)
Memory card error	The SD Memory Card has a problem, and image capture and playback are impossible. It may be viewable on a computer but not with this camera.
Card not formatted	The SD Memory Card you have inserted is unformatted or has been formatted on other device and is not compatible with this camera. Use the card after formatting it with this camera. (p.214)
Card locked	A locked SD Memory Card is inserted in the camera. Unlock the SD Memory Card. (p.43)
The card is electronically locked	Data are protected by the SD Memory Card security feature.
This image cannot be enlarged	You are trying to enlarge an image that cannot be enlarged.
This image is protected	You are trying to delete an image that is protected. Remove protection from the image. (p.184)
Battery depleted	The batteries are exhausted. Install new batteries in the camera. (p.37)

Error Message	Description
Not enough battery remaining to clean sensor	Appears during sensor cleaning if the battery level is insufficient. Replace the batteries with new ones or use an AC adaptor kit K-AC84 (optional). (p.40)
Not enough battery remaining to activate Pixel Mapping	Appears during pixel mapping if the battery level is insufficient. Replace the batteries with new ones or use an AC adaptor kit K-AC84 (optional). (p.40)
Image folder cannot be created	The maximum folder number (999) and file number (9999) are being used, and no more images can be saved. Insert a new SD Memory Card or format the card. (p.214)
The image is not stored	The image could not be saved because of an SD Memory Card error.
Settings not stored	The DPOF settings or rotation information could not be saved because SD Memory Card is full. Delete unwanted images and perform DPOF settings or rotation again. (p.73)
NG	The camera was unable to measure the manual white balance or detect dust on the sensor. Try the operation again. (p.161, p.244)
No more images can be selected	You cannot select 100 or more images to delete at a time. (p.180)
This RAW file cannot be developed	RAW files captured with other cameras cannot be edited on this camera.
This image cannot be filtered	Appears when digital filter is started for images captured with other cameras.
The camera failed to create an image	The creation of an index print image failed. (p.172)
No DPOF files	No files are set with DPOF. Set DPOF and then print. (p.200)
Printer error	There is an error with the printer and the file cannot be printed. Fix all the errors and try printing again.
No paper in the printer	Printer has run out of paper. Put paper in the printer and print.
Printer settings are changed	The camera received a notification that the printer status has changed. Press the OK button to reconnect to the printer.

Error Message	Description
Low paper level in the printer	Printer is running out of paper. This appears when this signal is received from the printer. After two seconds, the printer resumes printing.
Low ink level in the printer	Printer is running out of ink. This appears when this signal is received from the printer. After two seconds, the printer resumes printing.
No ink in the printer	Printer has run out of ink. Replace ink and print.
Paper stuck in the printer	Paper is jammed in the printer. Remove paper and print.
Data error	A data error has occurred during printing.
Turn the power off	This appears when exiting the PictBridge mode. Turn the camera off.

We recommend checking the following items before contacting a service center.

Problem	Cause	Remedy
The camera does not turn on	Batteries are not installed	Check if batteries are installed. If not, install charged batteries.
	Batteries are not installed properly	Check orientation of batteries. Re-insert batteries according to the ⊕⊖ symbols. (p.37)
	The battery power is low	Replace with charged batteries or use the AC adapter kit K-AC84 (optional). (p.40)
The shutter cannot be released	The lens aperture ring setting is other than the A position	Set the lens aperture ring to the A position (p.91) or select [Permitted] in [19. Using aperture ring] in the [C Custom Setting 3] menu. (p.241)
	The flash is charging	Wait until charging is finished.
	There is no available space on the SD Memory Card	Insert an SD Memory Card with available space or delete unwanted images. (p.42, p.73)
	Recording	Wait until recording is finished.
The Autofocus does not work	The subject is difficult to focus on	Autofocus cannot focus well on subjects that have low contrast (sky, white walls), dark colors, intricate designs, rapidly-moving objects or scenery shot through a window or a net-like pattern. Lock focus on another object located at the same distance as your subject, then aim at target and press the shutter release button fully. Alternatively, use manual focus. (p.116)
	The subject is not in the focusing area	Position the subject in the focus frame in the middle of the viewfinder. If the subject is outside the focusing area, aim the camera at the subject and lock the focus, then compose a picture and press the shutter release button fully. (p.114)
	The subject is too close	Move away from the subject and take a picture.
	The focus mode is set to MF	Set the focus mode lever to AF . (p.109)

Problem	Cause	Remedy
The subject is not in focus	AF Mode is set to AF.C	Autofocus is not locked (focus lock) when AF Mode is set to AF.C (including when the setting is automatically selected in AF.A). The camera will continue focusing on the subject while the shutter release button is pressed halfway. If there is a subject that you want to focus on, set AF Mode to AF.S (Single mode) and use the focus lock. (p.111)
	The Capture mode is set to  in Picture mode, or  ,  ,  or  in SCN mode.	Set Capture mode to any setting other than  (Moving Object) in Picture mode, or  (Stage Lighting),  (Kids),  (Pet) or  (Night Snap) in SCN (Scene) mode. (p.80)
The AE lock function does not operate	The exposure mode is set to M mode or the shutter speed is set to Bulb	Set the exposure mode to any setting other than M (Manual) mode, or set the shutter speed to any setting other than Bulb . (p.98, 100)
The flash does not discharge	When Flash Mode is set to  or  , the flash will not discharge if the subject is bright	Set Flash Mode to  (Flash On) or  (Flash On+Red-eye). (p.65)
	Mode dial is set to 	Set mode dial to any setting other than  (Flash Off). (p.80)
	SCN mode is set to  ,  ,  ,  or 	Set SCN (Scene) mode to any setting other than  (Night Scene),  (Sunset),  (Stage Lighting),  (Candlelight) or  (Museum). (p.82)
The power zoom system does not function	The camera does not have the power zoom function	Use manual zoom. (p.64)
The USB connection with a computer does not work properly	The USB Connection is set to [PictBridge]	Set [USB Connection] in the [ Set-up 2] menu to [PC]. (p.204) Refer to p.11 of the "PENTAX PHOTO Browser 3/PENTAX PHOTO Laboratory 3 Operating Manual" for details on connecting the camera to a computer.

Problem	Cause	Remedy
The USB connection with a printer does not work properly	The USB Connection is set to [PC]	Set [USB Connection] in the [↖ Set-up 2] menu to [PictBridge]. (p.204)
Shake Reduction does not work	The Shake Reduction function is off	Turn on the Shake Reduction function. (p.122)
	The Shake Reduction function is not set properly	If a lens for which focal length information cannot be acquired is used, set the [Focal Length] on the [Input Focal Length] menu. (p.124)
	Shutter speed is too low for the Shake Reduction function to be effective when panning or shooting night scenes, etc.	Turn off the Shake Reduction function and use a tripod.
	The subject is too close	Move away from the subject, or turn off the Shake Reduction function and use a tripod.



In rare cases, the camera may not operate correctly due to static electricity. This can be remedied by taking the batteries out and putting them back in again. When the mirror remains in the up position, take the batteries out and put them back in again. Then, turn the power on. The mirror will retract. After the procedure is done, if the camera operates correctly, it does not require any repairs.

Main Specifications

Type	TTL autofocus, auto-exposure SLR digital-still camera with built-in retractable P-TTL flash
Effective Pixels	Approx. 10.2 megapixels
Sensor	Total pixels approx. 10.75 megapixels, Primary color filter, interline/interlace scan CCD
Recorded Pixels	10M (RAW: 3872×2592 pixels), 10M (JPEG: 3872×2592 pixels), 6M (3008×2000 pixels), 2M (1824×1216 pixels)
Sensitivity (Standard output sensitivity)	Auto, Manual (ISO 100 to 3200 (EV steps can be set to 1 EV, 1/2 EV or 1/3 EV))
File Format	RAW (PEF/DNG), JPEG (Exif 2.21), DCF 2.0 compliant, DPOF compatible, Print Image Matching III compatible, RAW+JPEG simultaneous capturing compatible
JPEG Quality	★★★ (Best), ★★ (Better), and ★ (Good)
Storage Medium	SD Memory Card, SDHC Memory Card



Number of Shots

Recorded Pixels	File Format/ JPEG Quality	Capacity					
		4GB	2GB	1GB	512MB	256MB	128MB
10M 3872×2592	RAW (PEF)	Approx. 236	Approx. 120	Approx. 59	Approx. 29	Approx. 14	Approx. 7
	RAW (DNG)	Approx. 235	Approx. 119	Approx. 58	Approx. 29	Approx. 14	Approx. 7
10M 3872×2592	★★★	Approx. 921	Approx. 469	Approx. 231	Approx. 115	Approx. 58	Approx. 29
	★★	Approx. 1371	Approx. 698	Approx. 343	Approx. 171	Approx. 86	Approx. 44
	★	Approx. 2320	Approx. 1181	Approx. 586	Approx. 293	Approx. 147	Approx. 75
6M 3008×2000	★★★	Approx. 1547	Approx. 787	Approx. 387	Approx. 193	Approx. 97	Approx. 50
	★★	Approx. 2277	Approx. 1159	Approx. 570	Approx. 284	Approx. 143	Approx. 73
	★	Approx. 3893	Approx. 1982	Approx. 974	Approx. 487	Approx. 245	Approx. 125
2M 1824×1216	★★★	Approx. 3549	Approx. 1807	Approx. 902	Approx. 450	Approx. 227	Approx. 116
	★★	Approx. 6034	Approx. 3073	Approx. 1549	Approx. 774	Approx. 390	Approx. 200
	★	Approx. 10057	Approx. 5121	Approx. 2627	Approx. 1313	Approx. 662	Approx. 339

JPEG Quality (Compression): ★★★ (Best) = 1/4.5, ★★ (Better) = 1/8, ★ (Good) = 1/16

White Balance	Auto, Daylight, Shade, Cloudy, Fluorescent Light (D: Daylight, N: Neutral White, W: White), Tungsten Light, Flash, Manual, fine tuning available
Monitor	2.7 inch wide viewing field TFT color LCD with approx. 230,000 dots, brightness and color adjustment functions

Playback Function	Single frame, 4-image display, 9-image display, 16-image display, zoom display (up to 16 times, scrolling possible), image comparison, rotating, calendar display, folder display, slideshow, histogram, bright/dark area, resize, cropping, Index (Thumbnails/Square/Random 1/Random 2/Random 3)
Exposure Mode	P Program, Sv Sensitivity priority, Tv Shutter priority, Av Aperture priority, M Manual Picture mode: Auto Picture, Portrait, Landscape, Macro, Moving Object, Night Scene Portrait, Flash Off Scene mode: Night Scene, Surf & Snow, Food, Sunset, Stage Lighting, Kids, Pet, Candlelight, Museum, Night Snap
Shutter	Electronically controlled vertical-run focal-plane shutter, Speed range (1) Auto 1/4000 to 30 sec. (stepless), (2) Manual 1/4000 to 30 sec. (1/2 EV steps or 1/3 EV steps), Bulb, Electromagnetic release, Shutter lock by setting Main switch in OFF position
Lens Mount	PENTAX KAF2 bayonet mount (AF coupler, lens information contacts, K-mount with power contacts)
Lens Used	PENTAX KAF3 mount lenses, KAF2 mount lenses (power zoom not available), KAF mount lenses, KA mount lenses
Autofocus System	TTL phase-matching autofocus system, SAFOX (5-point AF), Wide/Spot switching, AF operational brightness range: EV -1 to 18 (at ISO 100 with f/1.4 lens), Focus lock available, Focus Mode: AFA (Auto)/ AFS (Single)/ AFC (Continuous)/ MF
Viewfinder	Penta-mirror viewfinder, Natural-Bright-Matte II focusing screen, Field of view: approx. 96%, Magnification: approx. 0.85× (with 50 mm f/1.4 lens at ∞), Diopter: approx. -2.5 to +1.5m ⁻¹ (per meter)
Viewfinder Indication	Focus information: is displayed when in-focus and blinking when unable to focus, is lit = Built-in flash ready, is blinking = Flash should be used, Shutter speed, Confirm Sensitivity, Aperture value, e-dial enabled indicator, = AE lock, Capacity remaining, = EV Compensation, MF = Manual focus, Picture mode icon, Shake Reduction display
Preview Function	Digital Preview: Composition, exposure, focus and white balance confirmation
Continuous shooting (Hi/Lo)	Approx. 3.5 fps (JPEG (), , Hi): up to 5 frames, RAW: up to 4 frames) Approx. 1.1 fps (JPEG (, , Lo): until SD Memory Card is full, RAW: up to 7 frames)
Self-timer	Electronically controlled with delay time of 12 sec./2 sec. (with mirror up function). Start by pressing the shutter release button. Operation confirmation: Possible to set beep. Can be cancelled after activation

Remote Control	PENTAX Remote Control F (optional) Release shutter immediately or three seconds after pressing the remote control shutter release button
Mirror	Quick-return mirror, mirror up function (2 sec. self-timer)
Digital Filter	Toy Camera, High Contrast, Soft, Star Burst, Retro, Extract color, Illustration, HDR, B&W, Sepia, Color, Slim, Brightness, Custom
Custom Image	Image Tone (6 types), Saturation/Filter Effect, Hue/Toning, Contrast, Sharpness/Fine Sharpness
Exposure Bracket	Three frames (underexposed, proper exposure and overexposed) are shot continuously with exposure bracketing. (Selectable between 1/2 EV and 1/3 EV for EV steps)
Exposure Meter/ Exposure Range	TTL multi (16-segment metering), Exposure range from EV 0 to EV 21 at ISO 100, with 50 mm f/1.4 lens, Center-weighted or Spot metering method can be set
EV Compensation	±3 EV (1/2 EV Steps), ±2 EV (1/3 EV Steps), EV Steps can be selected
AE Lock	Can be assigned to the AF button using the Custom Functions (timer type: two times the meter operating time set in Custom Setting) Continuous as long as the shutter release button is halfway pressed.
Built-in Flash	P-TTL built-in flash with serial control, GN approx. 11 (ISO 100), Angles of coverage: 28 mm lens angle of view (35 mm equivalent), Flash synchronization speed range at 1/180 sec. and slower, Daylight-sync flash, Slow-speed-sync flash, ISO range = P-TTL: 100 to 3200, Auto-popup function
External Flash Sync	Hot shoe with X -contact, which couples with PENTAX dedicated auto flashes, ISO range = P-TTL: 100 to 1600, Automatic flash, Red-eye reduction flash function, High-speed-sync and wireless-sync with PENTAX dedicated flash
Custom Function	21 functions can be set
Time Function	World Time settings for 75 cities (28 time zones)
Shake Reduction Function	CCD Image Sensor Shift, effective compensation range = up to 4 EV (dependent on the used lens type and shooting conditions)
Dust Removal	SP coating and CCD operations for dust removal. Can be set to operate when the camera is turned on.
Power	Four AA lithium, AA Ni-MH rechargeable, or AA alkaline batteries
Battery Exhaustion	Battery exhaustion symbol  is lit. (The shutter is locked when  starts blinking.)
In/Out Port	USB/Video terminal (USB 2.0 (high speed compatible))
Video Output Format	NTSC/PAL

PictBridge	Compatible printer: PictBridge-compatible printer Print mode: Single Image, All Images, DPOF AUTOPRINT
Dimensions and Weight	Approx. 122.5 mm (W) × 91.5 mm (H) × 67.5 mm (D) (excluding protrusions), approx. 525 g (body only), approx. 590 g (including four AA lithium batteries and an SD Memory Card), approx. 625 g (including four AA alkaline batteries and an SD Memory Card)
Accessories	Hot shoe cover Fk, Eyecup Fc, Body mount cover, USB Cable I-USB7, Software (CD-ROM) S-SW84 (PENTAX PHOTO Browser 3/PENTAX PHOTO Laboratory 3), Strap O-ST84, AA lithium batteries (four), Operating Manual (this book), Quick Guide, PENTAX PHOTO Browser 3/PENTAX PHOTO Laboratory 3 Operating Manual
Languages	English, French, German, Spanish, Portuguese, Italian, Dutch, Danish, Swedish, Finnish, Polish, Czech, Hungarian, Turkish, Greek, Russian, Korean, Chinese (Traditional/Simplified) and Japanese

AdobeRGB

Color space recommended by Adobe Systems, Inc. for commercial printing. Wider range of color reproduction than sRGB. Covers most of the color range so colors only available when printed are not lost when editing images on a computer. When image is opened by non-compatible software, the colors look lighter.

AE Metering

Brightness of subject is measured to determine exposure. In this camera, select from [Multi-segment Metering], [Center-weighted Metering] and [Spot Metering].

Aperture

The aperture increases or reduces the light beam (thickness) passing through the lens to the CCD.

Auto Bracket

For automatically changing exposure. When the shutter release button is pressed, three images are captured. The first one has no compensation, the second is underexposed and the third is over-exposed.

Bright Portion

Overexposed area in the image loses contrast and appears white.

Camera Shake (Blur)

When the camera moves while the shutter is open, the entire image appears blurred. This occurs more often when shutter speed is low. Prevent camera shake by raising the sensitivity, using the flash, or raising the shutter speed. Alternatively, use a tripod to stabilize the camera. As camera shake is mostly likely to occur when pressing the shutter release button, use the Shake Reduction function, the self-timer or the remote control unit to prevent camera movement.

CCD (Charge Coupled Devices)

Photography element which converts the light entering through the lens into electric signals that create the image.

Color Space

A defined range of colors from the spectrum which are used. In digital cameras, [sRGB] is defined as the standard by Exif. In this camera, [AdobeRGB] is also used because of the richer color expression over sRGB.

Color Temperature

This numerically expresses the color of the light source illuminating the subject. This is indicated in absolute temperature, using Kelvin (K) units. The color of light shifts to a bluish color as the color temperature rises, and to a reddish color as the color temperature falls.

Dark Portion

Underexposed area in the image loses contrast and appears black.

DCF (Design rule for Camera File system)

A digital camera file system standard established by the Japan Electronics and Information Technology Industries Association (JEITA).

Depth of field

Area of focus. This depends on the aperture, lens focal length, and distance to the subject. For example, select a smaller aperture (higher number) to increase the depth of field or use a larger aperture (smaller number) to decrease the depth of field.

DNG RAW file

DNG (Digital Negative) is a general-purpose RAW file format designed by Adobe Systems. When images captured in proprietary RAW formats are converted to DNG format, support and compatibility for the images increases significantly.

DPOF (Digital Print Order Format)

Rules for writing information onto a card with recorded images regarding the specific images and number of copies to be printed. Prints can easily be made by taking images to a DPOF photo printing store.

Dynamic Range (D-Range)

Indicated with a value expressing the light level reproducible in an image. This is the same as the term "Exposure latitude" used with silver halide film. Generally, when the dynamic range is wide, too much bright and/or too much dark areas are less likely to occur within the image, and when the dynamic range is narrow, all image tones can be reproduced sharply and accurately.

EV (Exposure Value)

Exposure value is determined by the combination of the aperture value and the shutter speed.

EV Compensation

Process of adjusting the image brightness by changing the shutter speed and/or aperture value.

Exif (Exchangeable image file format for digital still camera)

A standard digital camera file format established by the Japan Electronics and Information Technology Industries Association (JEITA).

Focus point

Position in the viewfinder that determines focus. In this camera, select from [Wide] and [Spot].

Histogram

A graph that shows the darkest and brightest points in an image. The horizontal axis represents the brightness and the vertical axis represents the number of pixels. This is useful when you wish to refer to the exposure status of an image.

ISO Sensitivity

The level of sensitivity to light. With a high sensitivity, images can be shot with a high shutter speed even in dark places, reducing camera shake. However, images taken with a high sensitivity are more susceptible to noise.

JPEG

An image compression method. In this camera, select from ★★★ (Best), ★★ (Better), or ★ (Good). Images recorded in JPEG format are suited for viewing on your computer or for attaching to e-mail.

ND (Neutral Density) Filter

A filter available in different saturation levels that adjusts the brightness without affecting the color tone of pictures.

Noise Reduction

Process to reduce noise (image roughness or unevenness) caused by slow shutter speed or high sensitivity shooting.

NTSC/PAL

These are video output formats. NTSC is mainly used in Japan, North America, and South Korea. PAL is mainly used in Europe and in China.

Quality Level

This refers to the image compression ratio. The lower the compression, the more detailed the image. The image becomes rougher as the compression rate rises.

RAW data

Unedited image data output from the CCD. RAW data are data before being internally processed by the camera. Camera settings at the time of capture, such as White Balance, Contrast, Saturation, and Sharpness can be set for each frame after shooting. In addition, RAW data are 12 bit data that contain 16 times the information of 8 bit JPEG data. Rich gradations are possible. Transfer RAW data to your computer and use the provided software to create image data with different settings, such as JPEG.

Recorded Pixels

Indicates the size of the image by the number of pixels. The more pixels that compose a picture, the larger the image size.

Shutter Speed

The length of time that the shutter is open and light strikes the CCD. The amount of light that strikes the CCD can be changed by altering the shutter speed.

sRGB (standard RGB)

International standard of color space established by the IEC (International Electrotechnical Commission). This is defined from color space for computer monitors and is also used as the standard color space for Exif.

























Vignetting

The picture edges are blackened when part of the light coming from the subject is blocked by the hood or filter ring, or when the flash is partially blocked by the lens.

White Balance

While shooting, color temperature is adjusted to match the light source so that the subject appears to have correct color.

Symbols

[C Custom Setting]	
Menu	78, 239
 (Playback)	
button	19, 21, 72
[ Playback] Menu	166, 237
[ Rec. Mode] Menu	77, 236
 (Delete) button	21, 73
[ Set-up] Menu	212, 238
 (Help)	
button	19, 21, 34, 154
 UP (Flash pop-up)	
button	19, 65
 Av (EV Compensation)	
button	19, 104
 Auto Picture	81
 Portrait	81
 Landscape	81
 Macro	81
 Moving Object	81
 Night Scene Portrait	81
 Flash Off	81
 Night Scene	82
 Surf & Snow	82
 Food	82
 Sunset	82
 Stage Lighting	82
 Kids	82
 Pet	82
 Candlelight	82
 Museum	82
 Night Snap	82
A	
AC Adapter	40
Accessories	248
Adjust White Balance	162

AdobeRGB	164
AE Lock	105, 115
AE Metering	101
AF (Autofocus)	109
AF button	19, 110
AF Mode	111
AF160FC	140
AF200FG	140
AF360FGZ	140
AF540FGZ	140
Alkaline batteries	37
Aperture	85
Aperture Priority Mode Av	96
Auto Bracket	106
Auto discharge	67
Auto Picture 	81
Auto Power Off	225
Autofocus AF	109
Automatic Sensitivity	
Correction	88
Av (Aperture Priority) mode	96
AV Equipment	186

B

B&W (Digital Filter)	192
Batteries	37, 226
Beep	215
Brightness (Digital Filter)	193
Brightness Level	221
Brightness of the Monitor	221
Built-in Flash	65
Bulb Shooting	100



C

Calendar display	171
Camera shake	121
Candlelight 	82
Capture Information	23, 24

- Capture Mode 80
- Card access lamp 17
- Catch-in focus 118
- CCD cleaning 243
- Center-weighted 103
- City names 218
- Cloudy (White Balance) 159
- Color (Digital Filter) 192
- Color of the monitor 222
- Color Space 164
- Color Temperature 160
- Continuous Autofocus 115
- Continuous mode
 - A.F.C.** 109, 111
 - Continuous Shooting 130
 - Contrast 157
 - Contrast-Control-Sync (Flash) 148
 - Control panel 23, 31
 - Correct exposure 85
 - Cropping 190
 - Custom (Digital Filters) 193
 - Custom Image 157
 - Custom Setting 78
 - [**C** Custom Setting] Menu 78, 239
- D**
 - Date Adjust 54
 - Date change 216
 - Date imprint 201, 206
 - Daylight (White Balance) 159
 - Daylight-Sync Shooting 70
 - Delete 73, 180
 - Delete All Images 183
 - ☒ (Delete) button 21, 73
 - Delete Folder 182
 - Deleting a Single Image 73
 - Depth of field 86
 - Digital Filter 132, 192
 - Digital Preview 119
 - Diopter Adjust 48
 - Direct keys 30, 76, 236
 - Direct Printing 203
 - Display Language 219
 - DPOF AUTOPRINT 209
 - DPOF Settings 200
 - Drive Mode 76
 - Dust Alert 244
 - Dust Removal 243
- E**
 - e-dial 19, 21
 - e-dial in Program 92
 - Error Message 252
 - EV Compensation 104
 - ☒ **Av** (EV Compensation) button 19, 104
 - EV Steps 105
 - Expand Dynamic Range 88
 - Exposure 85
 - Exposure metering timer 108
 - Exposure Mode 89
 - Exposure Warning 95, 97, 99
 - External flash 140
 - Extract color (Digital Filter) 132, 192
 - Eyecup 48
- F**
 - File Format 152
 - File number 224
 - Filter 132, 192
 - Filter Effect 157
 - Fireworks 100
 - Fix Focus 114
 - Flash 65, 135
 - Flash (White Balance) 159
 - Flash Exposure Compensation 70
 - Flash Off ☒ 81
 - Flash On mode 68

- ⚡UP** (Flash pop-up)
 - button 19, 65
- Fluorescent Light
 - (White Balance) 159
- Focal Length 124
- Focus Indicator 116
- Focus Lock 114
- Focus Mode 109
- Focus mode lever 19, 109
- Focus point 113
- Focusing 109
- Folder display 171
- Folder Name 224
- Food **🍴** 82
- Format 214
- Four-way controller
 - (**▲▼◀▶**) 19, 21
- G**
- Guide display 22, 220
- H**
- HDR (Digital Filter) 192
- Help function 34
- High Contrast
 - (Digital Filter) 132, 192
- High-ISO Noise Reduction 89
- High-Speed Flash Sync
 - Mode 142
- Histogram 26
- Hue 157
- I**
- Illustration (Digital Filter) 192
- Image Comparison 176
- Image Tone 157
- Index 172
- INFO** button 19, 21, 23, 72
- Initial Settings 50, 236
- Input Focal Length 124
- Instant Review 61, 222
- ISO sensitivity 87
- J**
- JPEG Quality 44, 151
- JPEG Recorded Pixels 44, 150
- K**
- Kids **👶** 82
- L**
- Landscape **▲** 81
- Language Setting 50
- LCD Color Tuning 222
- Lens 46, 240
- Lens unlock button 19, 47
- Lithium batteries 37
- Lock Exposure 115
- M**
- M** (Manual) Mode 98
- Macro **🍷** 81
- Main switch 19, 21, 49
- Manual focus **MF** 116
- Manual Mode **M** 98
- Manual White Balance 161
- Matte Field 117
- Memory 229
- MENU** button 19, 21, 30, 32
- Menu Operation 32, 30
- Meter Operating Time 103
- Metering method 101
- MF** (Manual focus) 116
- Mirror Up 127, 247
- Mode dial 19, 80, 81
- Mode Palette 83
- Monitor 22
- Moving Object **👤** 81
- Multi-image display 169
- Multiple Flashes 147
- Multi-segment 102
- Museum **🏛️** 82





N

Night Scene (Bulb Mode)	100
Night Scene 	82
Night Scene Portrait 	81
Night Snap 	82
Ni-MH	37
Ni-MH rechargeable batteries	37
Nine-Image Display	169
Noise Reduction	89
NTSC	225

O

OK button	19, 21
Optional Accessories	248

P

P (Program) Mode	90
PAL	225
Pet 	82
PictBridge	203
Picture mode	81
Pixel Mapping	228
Pixels	150
Playback	24, 72
 (Playback) button	19, 21, 72
Playback display method	168
 [Playback] Menu	166, 237
Playback Time	39
Portrait 	81
Power	49
Power Lamp	17
Power lamp	227
Press fully	62
Press halfway	62
Print All Images	208
Print Service	200
Print Single Image	206
Printer connection	205
Program Mode P	90

Protect	184
P-TTL (Flash)	145
P-TTL Auto (Flash)	141

Q



Quality Level	44, 151
---------------------	---------

R

RAW	152
RAW Development	195
RAW file format	153
 [Rec. Mode] Menu	77, 236
Recorded Pixels	44, 150
Red-eye reduction	69, 145
Remaining image storage capacity	39
Remote Control	128
Reset	231
Resize	188
Retro (Digital Filter)	132, 192
Rotate	175

S

Saturation	157
SCN (Scene)	82
SD Memory Card	42
Select battery	226
Select&Delete	180
Self-timer	125
Sensitivity	87
Sensitivity Priority Mode Sv	92
Sensor Cleaning	246
Sepia (Digital Filter)	192
 [Set-up] Menu	212, 238
Shade (White Balance)	159
Shadow Compensation	78, 239
Shake Reduction	121
Sharpness	157
Shutter Priority Mode Tv	94
Shutter release button	19, 21, 62

Shutter Speed	85
Single mode AfS	109, 111
Slideshow	177
Slim (Digital Filter)	192
Slow Shutter Speed NR	89
Slow-Speed-Sync	136
Soft (Digital Filter)	132, 192
Spot Metering	103
sRGB	164
Stage Lighting 	82
Star Burst (Digital Filter)	132, 192
Status display	221
Status screen	23
Strap	36
Sunset 	82
Surf & Snow 	82
Sv (Sensitivity Priority) Mode	92

T

Text Size	220
Toning	157
Toy Camera (Digital Filter)	132, 192
Trailing curtain sync	146
Tungsten Light (White Balance)	159
TV	186
Tv (Shutter Priority) mode	94

U

USB cable	205
USB Connection	204
Using aperture ring	241

V

Video cable	186
Video Output Format	225
Viewfinder	28, 48
Vignetting	266

W

AWB (White Balance)	159
White Balance	159
Wireless Mode (Flash)	142
World Time	216

Z

Zoom Display	167
Zoom Lens	64

All PENTAX cameras purchased through authorized bona fide photographic distribution channels are guaranteed against defects of material or workmanship for a period of twelve months from date of purchase. Service will be rendered, and defective parts will be replaced without cost to you within that period, provided the equipment does not show evidence of impact, sand or liquid damage, mishandling, tampering, battery or chemical corrosion, operation contrary to operating instructions, or modification by an unauthorized repair shop. The manufacturer or its authorized representatives shall not be liable for any repair or alterations except those made with its written consent and shall not be liable for damages from delay or loss of use or from other indirect or consequential damages of any kind, whether caused by defective material or workmanship or otherwise; and it is expressly agreed that the liability of the manufacturer or its representatives under all guarantees or warranties, whether expressed or implied, is strictly limited to the replacement of parts as hereinbefore provided. No refunds will be made on repairs by non-authorized PENTAX service facilities.

Procedure During 12-month Warranty Period

Any PENTAX which proves defective during the 12-month warranty period should be returned to the dealer from whom you purchased the equipment or to the manufacturer. If there are no representatives of the manufacturer in your country, send the equipment to the manufacturer, with postage prepaid. In this case, it will take a considerable length of time before the equipment can be returned to you owing to the complicated customs procedures required. If the equipment is covered by warranty, repairs will be made and parts replaced free of charge, and the equipment will be returned to you upon completion of servicing. If the equipment is not covered by warranty, regular charges of the manufacturer or of its representatives will apply. Shipping charges are to be borne by the owner. If your PENTAX was purchased outside of the country where you wish to have it serviced during the warranty period, regular handling and servicing fees may be charged by the manufacturer's representatives in that country. Notwithstanding this, your PENTAX returned to the manufacturer will be serviced free of charge according to this procedure and warranty policy. In any case, however, shipping charges and customs clearance fees to be borne by the sender. To prove the date of your purchase when

required, please keep the receipt or bills covering the purchase of your equipment for at least a year. Before sending your equipment for servicing, please make sure that you are sending it to the manufacturer's authorized representatives or their approved repair shops, unless you are sending it directly to the manufacturer. Always obtain a quotation for the service charge, and only after you accept the quoted service charge, instruct the service station to proceed with the servicing.

- **This warranty policy does not affect the customer's statutory rights.**
- **The local warranty policies available from PENTAX distributors in some countries can supersede this warranty policy. Therefore, we recommend that you review the warranty card supplied with your product at the time of purchase, or contact the PENTAX distributor in your country for more information and to receive a copy of the warranty policy.**



The CE Mark is a Directive conformity mark of the European Union.

For customers in USA**STATEMENT OF FCC COMPLIANCE**

This device complies with Part 15 of the FCC Rules. Operation is subject to the following two conditions: (1) This device may not cause harmful interference, and (2) this device must accept any interference received, including interference that may cause undesired operation.

Changes or modifications not approved by the party responsible for compliance could void the user's authority to operate the equipment.

This equipment has been tested and found to comply with the limits for a Class B digital device, pursuant to part 15 of the FCC Rules.

These limits are designed to provide reasonable protection against harmful interference in a residential installation. This equipment generates, uses and can radiate frequency energy and, if not installed and used in accordance with the instructions, may cause harmful interference to radio communications. However, there is no guarantee that interference will not occur in a particular installation.

If this equipment does cause harmful interference to radio or television reception, which can be determined by turning the equipment off and on, the user is encouraged to try to correct the interference by one or more of the following measures:

- Reorient or relocate the receiving antenna.
- Increase the separation between the equipment and receiver.
- Connect the equipment into an outlet on a circuit different from that to which the receiver is connected.

* Consult the dealer or an experienced radio/TV technician for help.

For customers in Canada

This Class B digital apparatus complies with Canadian ICES-003.

Pour les utilisateurs au Canada

Cet appareil numérique de la classe B est conforme à la norme NMB-003 du Canada.

FOR CALIFORNIA, U.S.A. ONLY

Perchlorate Material-special handling may apply.

The lithium battery used in this camera contains perchlorate material, which may require special handling.

See www.dtsc.ca.gov/hazardouswaste/perchlorate

Declaration of Conformity
According to 47CFR, Parts 2 and 15 for
Class B Personal Computers and Peripherals

We: PENTAX Imaging Company
A Division of PENTAX of America, Inc.

Located at: 600 12th Street, Suite 300
Golden, Colorado 80401 U.S.A.
Phone: 303-799-8000 FAX: 303-790-1131

Declare under sole responsibility that the product identified herein complies with 47CFR Parts 2 and 15 of the FCC rules as a Class B digital device. Each product marketed is identical to the representative unit tested and found to be compliant with the standards. Records maintained continue to reflect the equipment being produced can be expected to be within the variation accepted, due to quantity production and testing on the statistical basis as required by 47CFR §2.909. Operation is subject to the following two conditions: (1) This device may not cause harmful interference, and (2) This device must accept any interference received, including interference that may cause undesired operation. The above named party is responsible for ensuring that the equipment complies with the standards of 47CFR §15.101 to §15.109.

Product Name: PENTAX Digital Still Camera

Model Number: ***K-m/K2000***

Contact person: Customer Service Manager

Date and Place: October, 2008, Colorado

Information for Users on Collection and Disposal of Old Equipment and Used Batteries



1. In the European Union

These symbols on the products, packaging and/or accompanying documents mean that used electrical and electronic equipments and batteries should not be mixed with general household waste.

Used electrical/electronic equipments and batteries must be treated separately and in accordance with legislation that requires proper treatment, recovery and recycling of these products.

Following the implementation by member states, private households within the EU states may return their used electrical/electronic equipments and batteries to designated collection facilities free of charge*.

In some countries your local retailer may also take back your old product free of charge if you purchase a similar new one.

*Please contact your local authority for further details.



By disposing of this product correctly you will help ensure that the waste undergoes the necessary treatment, recovery and recycling and thus prevent potential negative effects on the environment and human health which could otherwise arise due to inappropriate waste handling.

2. In other countries outside the EU

These symbols are only valid in the European Union. If you wish to discard these items, please contact your local authorities or dealer and ask for the correct method of disposal.



For Switzerland: Used electrical/electronic equipment can be returned free of charge to the dealer, even when you don't purchase a new product. Further collection facilities are listed on the home page of www.swico.ch or www.sens.ch.

Note for the battery symbol (bottom two symbol examples):
This symbol might be used in combination with a designation for the chemical element or compound in use. In this case you have to comply with the requirement set by the Directive for the chemicals involved.

Memo

HOYA CORPORATION

PENTAX Imaging Systems Division

2-36-9, Maeno-cho, Itabashi-ku, Tokyo 174-8639, JAPAN
(<http://www.pentax.jp>)

**PENTAX Europe GmbH
(European Headquarters)**

Julius-Vosseler-Strasse 104, 22527 Hamburg,
GERMANY
(HQ - <http://www.pentaxeurope.com>)
(Germany - <http://www.pentax.de>)

PENTAX U.K. Limited

PENTAX House, Heron Drive, Langley, Slough, Berks
SL3 8PN, U.K.
(<http://www.pentax.uk>)

PENTAX France S.A.S.

112 Quai de Bezons, B.P. 204
95106 Argenteuil Cedex, FRANCE
(<http://www.pentax.fr>)

PENTAX Italia S.r.l.

Via Dione Cassio 15, 20138 Milano, ITALY
(<http://www.pentaxitalia.it>)

PENTAX (Schweiz) AG

Widenholzstrasse 1, 8304 Wallisellen, Postfach 367,
8305 Dietlikon, SWITZERLAND
(<http://www.pentax.ch>)

**PENTAX Europe GmbH
(Tyskland) Filial Sverige**

Box 650, 75127 Uppsala, SWEDEN
(<http://www.pentax.se>)

PENTAX Imaging Company

A Division of PENTAX of America, Inc.

(Headquarters)
600 12th Street, Suite 300 Golden, Colorado 80401, U.S.A.
(PENTAX Service Department)
12000 Zuni Street, Suite 100B Westminster, Colorado
80234, U.S.A.
(<http://www.pentaximaging.com>)

PENTAX Canada Inc.

1770 Argentia Road Mississauga, Ontario L5N 3S7,
CANADA
(<http://www.pentax.ca>)

**PENTAX Trading
(SHANGHAI) Limited**

23D, Jun Yao International Plaza, 789 Zhaojiabang Road,
Xu Hui District, Shanghai, 200032 CHINA
(<http://www.pentax.com.cn>)

<http://www.pentax.jp/english>

- Specifications and external dimensions are subject to change without notice.