

PENTAX

IQZ_{oom}60S

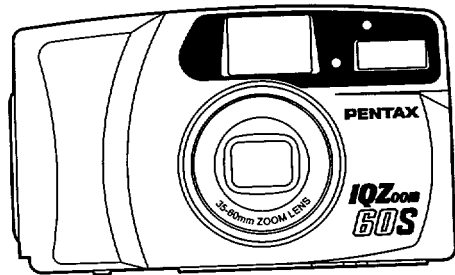

Operating manual

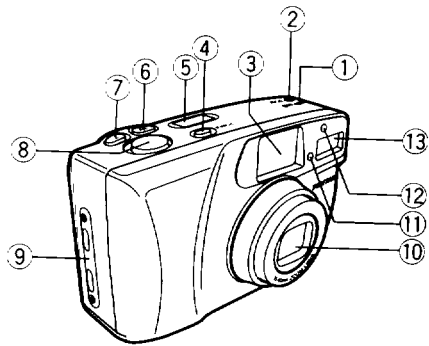

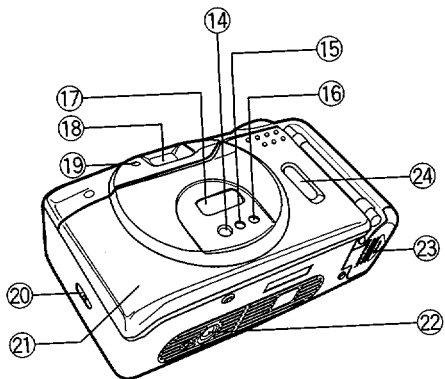

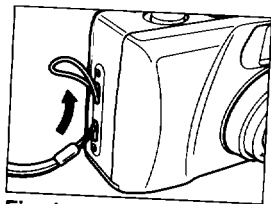

Fig. 1

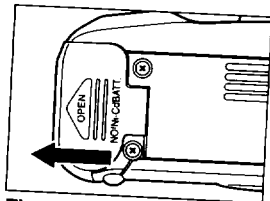
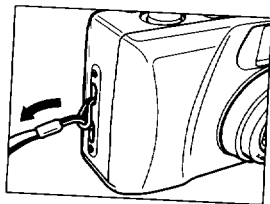
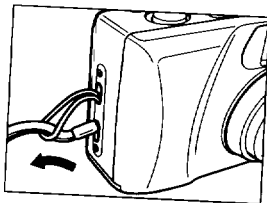

Fig. 2

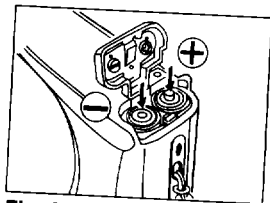

Fig. 3

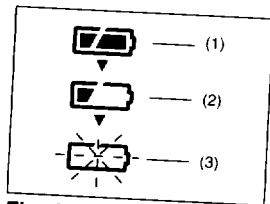

Fig. 4

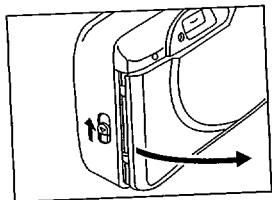

Fig. 5

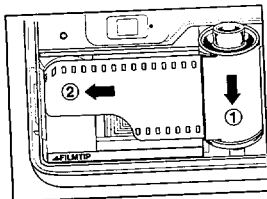

Fig. 6

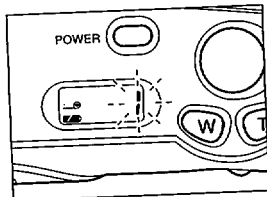

Fig. 7

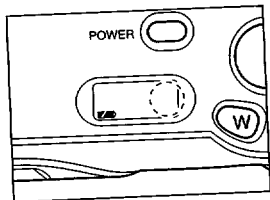

Fig. 8

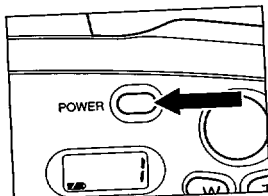

Fig. 9

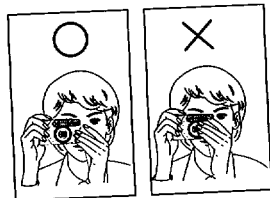

Fig. 10

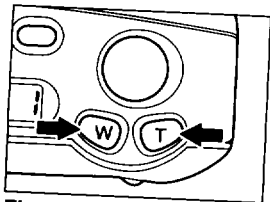

Fig. 11

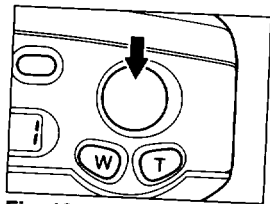

Fig. 12

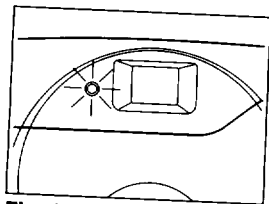

Fig. 13

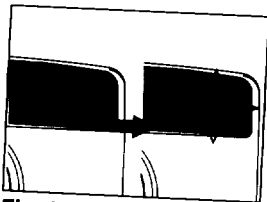

Fig. 14

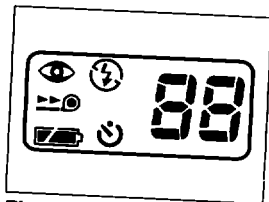

Fig. 15

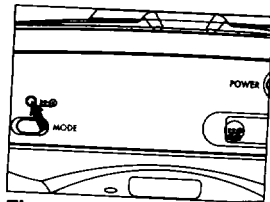

Fig. 16

CONTENTS

FOR SAFE USE OF YOUR CAMERA.....7	MODE SELECTION & LCD PANEL.....16
PRECAUTIONS FOR YOUR CAMERA....8	AUTO FLASH MODE.....17
PRECAUTIONS FOR BATTERY USAGE9	RED EYE REDUCTION MODE17
NAMES OF WORKING PARTS10	FILL-IN MODE18
ATTACHING THE STRAP11	FLASH-OFF MODE18
INSERTING THE BATTERY11	USING THE SELF-TIMER19
CHECKING THE BATTERY11	AUTO FILM REWIND19
SETTING THE FILM SPEED12	MID-ROLL REWIND.....19
LOADING THE FILM.....12	DATE IMPRINTING (DATE MODEL ONLY)20
AUTO POWER SAVING SYSTEM13	DATE PRINT SETTING.....20
HOLDING THE CAMERA13	DATE AND TIME ADJUSTMENT20
TAKING A PICTURE14	SPECIFICATIONS.....22
AUTOMATIC FLASH PHOTOGRAPHY..15	WARRANTY POLICY.....23
AUTOMATIC EXPOSURE(AE) LOCK15	

FOR SAFE USE OF YOUR CAMERA

Although we have carefully designed this camera for safe operation, please be sure to follow precautions given in this page.

⚠ WARNING This mark indicates precautions that if not followed, could result in serious injury to the operator.

⚠ CAUTION This mark indicates precautions that, if not followed, could result in minor or medium injury to the operator or damage to the equipment.

⚠ WARNING

- The electric circuits inside the camera contain high voltage working parts. Never attempt to disassemble the camera yourself.
- Never touch internal parts of the camera if they become exposed from dropping the camera or for some other reason, as there is danger of electric shock.
- Wrapping the strap around your neck is dangerous. Make sure that small children do not the strap caught their neck.
- Be sure to store batteries out of the reach of children. Seek medical assistance immediately if accidentally swallowed.

⚠ CAUTION

- Do not use the flash near anyone's eyes, as it may hurt them. Be particularly careful with the flash around the infants.
- Never try to disassemble, short or recharge the battery. Also, do not dispose of the battery in fire, as it may explode.
- Remove the battery from the camera immediately if it become hot or begin to smoke. Be careful not to burn yourself during removal.

PRECAUTIONS FOR YOUR CAMERA

Precautions when taking pictures

- Do not use the camera where it may come in contact with rain, water or any other liquid, because the camera is not weather, water, or liquid resistant. Should the camera get wet from rain, splashing water, or any other liquid, wipe it off immediately with a dry soft cloth.
- Do not drop the camera or allow it to hit a solid object. If the camera suffers a severe shock or impact, take it to a Pentax service center for inspection.
- Be careful not to subject the camera to strong vibrations, shock or pressure. Use a cushion to protect the camera when carrying it in a motorcycle, car, boat, etc.
- Condensation on the interior or the exterior of the camera may be extremely harmful to the camera mechanism as it may cause rust. Furthermore, if the camera is taken from warm temperature to a subfreezing one or vice versa, the formation of icelets may cause damage. In such a case, put the camera into a case or plastic bag so that any changes in temperature dif-

ference is minimized. Do not remove it from the bag until temperature has stabilized.

Precautions for storage

- Avoid leaving the camera for extended periods in places where temperature and humidity are high such as in a car.
- Do not store the camera in a closet with mothballs or in a case where chemicals are handled. Store it in a place with good air circulation to prevent fungus growth.

Precautions for proper care

- Use a blower and lens brush to remove dust accumulated on the lens or the viewfinder window.
- Never use solvents such as paint thinner, alcohol or benzene to clean the camera. To clean the external camera surfaces, - but not glass surfaces; using a dry or silicone-treated cloth is recommended.
- The electric circuits inside the camera contain high voltage working parts. Never attempt to disassemble the camera yourself.

Other precautions

- To maintain optimum performance, it is recommended that the camera be inspected every one or two years. If the camera has not been used for an extended period, or is being prepared for an important photographic session, it is recommended that you have the camera inspected or test shoot with it.
- The PENTAX warranty provided only for the repair of defects in materials or workmanship. Damage of any kind cannot be repaired at no charge under the term of the warranty. If the difficulty is caused as a direct result of the product being used in conditions as out lined in the other operation contrary to the instructions outlined in this manual, charges will be assessed or a repair quotation will be provided.

PRECAUTIONS FOR BATTERY USAGE

- Use two AA-size alkaline batteries.
- Ni-cd battery cannot be used.
- Misuse of a battery can cause hazards such as leakage, overheating, explosions, etc. The battery should be inserted with the "+" and "-" sides facing correctly.
- Never try to disassemble, short or recharge the battery. Also do not dispose of the battery in a fire, as it may explode.
- Battery performance may be temporarily hindered in low temperatures, but will recover in normal temperatures.
- Keep a spare battery on hand for replacement convenience when shooting outdoors or while traveling.
- Be sure to store the battery out of the reach of children. Seek medical assistance immediately if accidentally swallowed.

NAMES OF WORKING PARTS

- ① Mid-roll rewind button
- ② Mode switch
- ③ Viewfinder window
- ④ Power switch
- ⑤ LCD panel
- ⑥ Wide zoom button
- ⑦ Tele zoom button
- ⑧ Shutter release button
- ⑨ Strap eyelet
- ⑩ Lens/Lens cover
- ⑪ Photo sensor window
- ⑫ Self-timer LED

- ⑬ Built-in flash
- ⑭ Date set button
- ⑮ Date select button
- ⑯ Date mode button
- ⑰ Date LCD panel
- ⑱ Viewfinder eyepiece
- ⑲ Flash charge LED
- ⑳ Back cover latch
- ㉑ Back cover
- ㉒ Tripod socket
- ㉓ Battery chamber cover
- ㉔ Film check window

ATTACHING THE STRAP (Fig.1)

1. Insert the small loop at the end of the strap under the strap eyelet.
 2. Insert the other end of the strap through the loop to tie the strap onto the strap eyelet.
- The protruding part of the strap adjustment clip can be used to press the small buttons on the camera.

INSERTING THE BATTERY



1. Push the battery chamber cover latch toward the open direction and open the cover. **(Fig.2)**
2. Insert two AA-size batteries, checking that (+) and (-) on the battery are aligned according to the polarity information inside the battery chamber. **(Fig.3)**
3. Close the cover by pushing it back till it locks firmly in place with a click.

- Remove batteries from the camera when you do not expect to use it for a long period time.

CHECKING THE BATTERY

Conditions of the battery in camera can be checked at each power on.

The condition of the battery is displayed on the LCD panel. **(Fig. 4)**

1. The full battery mark () is displayed if the battery is in good condition.
2. The half battery mark () is displayed if the battery is nearly exhausted. When () shown there is enough power to finish a roll of film before replacing the battery.

3. The blank battery mark  is displayed when the battery is too low. With this condition all functions are locked, and the battery mark and film counter will blink. Please replace the battery immediately.

SETTING THE FILM SPEED

This camera is designed to use DX-coded films with ISO 100/200 to 400. Your camera automatically sets the correct film speed.

LOADING THE FILM

1. Push the back cover latch upward to open. **(Fig. 5)**
2. Load the film cassette into the film chamber and pull out enough film leader to extend past the film tip mark. **(Fig. 6)**
3. Make sure the film stays within the film chamber and lies flat. Close the back cover completely and the film will advance to the first frame automatically and "1" and "___●" are displayed on the LCD panel. **(Fig. 7)**
 - If "1" is not displayed on LCD panel, it indicates film loading failure. Please reload the film. **(Fig. 8)**
 - Whether the film is in camera or not can be confirmed by either the film check window or the film counter in the LCD panel.

AUTO POWER SAVING SYSTEM (Fig. 9)
If you don't use your camera for approximately 5 minutes, the camera will turn off automatically to save power. Press power switch again to turn on the power.

HOLDING THE CAMERA (Fig. 10)

1. Keep your elbows close to your body to hold the camera steady.
2. Whether for vertical or horizontal photography, hold the camera with both hands.
3. If the flash is used with the camera held vertically, the flash unit should position above the lens.

4. If the flash is used while holding the camera with the flash positioned below the lens the result will look unnatural.
5. Be careful that fingers, hair or the camera strap are not in the way of the lens, the auto-exposure windows or the flash.
6. Hold the camera firmly with both hands in a stable posture and press the shutter button with your finger tip.

TAKING A PICTURE (Fig. 11)

1. Press the power switch. The lens cover will open, and the lens barrel will extend to the picture-taking position (wide-angle position with 35mm focal length). The power will go on and the LCD panel indications will appear. Wipe lightly with a dry cloth if the lens is dirty or dusty.
2. Look into the viewfinder. The lens will zoom to the telephoto position if you push the zoom button T (60mm telephoto position).
3. The lens will zoom to the wide angle position if you push the zoom button W (35mm wide angle position).
4. Press the shutter release button completely to take the picture; the film will advance to the next exposure.
5. Turn off the power the lens will retract into camera.

- If the camera is left unused for approximately five minutes, the power will turn off automatically, the lens will retract and the LCD panel display will go off.
- Shooting distance:
35mm : 1.2m ~ ∞ (3.9ft ~ ∞)
60mm : 1.8m ~ ∞ (5.9ft ~ ∞)

AUTOMATIC FLASH PHOTOGRAPHY (Fig. 12,13,14)

1. If additional light is required, the built-in flash will activate automatically.
2. When the flash is fully recharged, the flash charge LED lights up, when the shutter release button is pressed.
 - When the flash is used, it will take several seconds to charge the flash fully.
 - A blinking flash symbol will be displayed on LCD panel when the flash is charging and the shutter release button will lock until the flash is fully charged.

Flash effective range:

(When negative color film is used.)

Lens \ ISO	100	400
35mm	1.2 - 3.2m (3.9 - 10ft)	1.2 - 6.3m (3.9 - 21ft)
60mm	1.8 - 2.0m (5.9 - 6.6ft)	1.8 - 3.9m (5.9 - 13ft)

AUTOMATIC EXPOSURE (AE) LOCK

1. Depress the shutter release button halfway down until the flash charge LED turns on.
2. With the shutter release button held at this point, compose the picture, and continue pressing the shutter release button fully down to take picture.
 - Do not change the shooting distance.
 - The automatic exposure lock is released if the finger is removed from the shutter release button before taking the picture.

MODE SELECTION & LCD PANEL (Fig.15)

Press the mode switch to select one of the photographic modes.

The selected mode is displayed on the LCD panel when the camera is on.

When the camera is turned on the auto flash mode will be automatically selected.

The sequence of the selected modes and displays are as following:

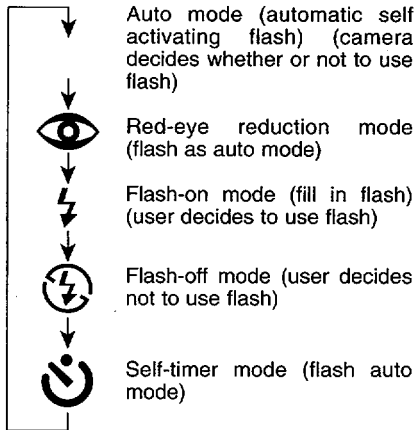

AUTO FLASH MODE

In this mode the flash will fire as needed according to the lighting conditions.

1. If sufficient light is measured through the auto-exposure metering sensor, the built-in flash will not activate when shutter releasing.
2. If insufficient light is measured through the auto-exposure metering sensor, it will require additional light for good photography. Then the built-in flash will activate automatically when the shutter is released.

RED-EYE REDUCTION MODE

Selecting this mode makes it possible to minimize the red-eye effect that sometimes occur when taking portrait photographs with flash.

1. Press the mode switch until  appears on the LCD panel.
 2. Press the shutter release button halfway so that the flash charge LED lights up.
 3. Press the shutter release button.
- Be sure to hold the camera still after pressing the shutter release button.

FILL-IN MODE

This mode will activate the flash when you want to photograph subjects with sunlight to their side or back. It lets you take more natural looking pictures by softening harsh shadows.

1. Press the mode switch until  appears on the LCD panel.
2. The flash will fire every time the shutter release button is pressed.

FLASH-OFF MODE

This mode turns the flash off allowing for available-light photography or for use where flash photography is prohibited.

1. Press the mode switch until  appears on the LCD panel.
2. Press the release button and the shutter will be release without flash.
 - In the flash-off mode, slow shutter speeds (up to 1/5 seconds) are used for available light. The use of a tripod is recommended to prevent the camera from shaking.

USING THE SELF-TIMER

1. Compose your picture with the camera on a steady support.
 2. Press the mode switch until  appears on the LCD panel. Press the shutter release button. The self-timer LED which is located on the front of your camera, will blink for approximately 7 seconds, the LED will light on for about 3 seconds to indicate that the shutter will be released and then the shutter will release.
- The self-timer can be cancelled by pressing the shutter release button again, or by turning off the power before shutter release.

AUTO FILM REWIND

1. The film will automatically rewind when the end of the roll is reached and the lens will retract into the camera.
 2. Rewinding will automatically stop after the film is completely rewound, and "0" and "⊙" will blink on the film counter LCD. Make sure that the blinking ⊙ appears before opening the back cover. Open the back cover and remove the film.
- If the film has gone past the standard number of exposures, the final two pictures may be double exposed.
 - If "0" does not display on the LCD counter after rewinding, press the mid-roll rewind button.

MID-ROLL REWIND (Fig. 16)

The film may be rewound before the roll is finished.

Use the protruding part of the strap clip to press mid-roll rewind button to rewind the film.

DATE IMPRINTING (DATE MODEL ONLY) DATE PRINT SETTING (Fig. A)

Press the mode button to select the date, time, and whether or not to print it on the film.

- The date unit must be reset after replacing the battery.

(Fig. A)

AUTO DATE

0141

MODE SELECT SET

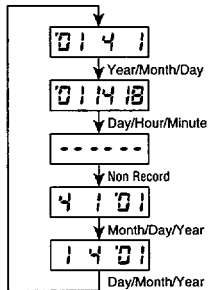

DATE AND TIME ADJUSTMENT (Fig. B)

- (1) Press the mode button until the year, month, and day appear on the display.
- (2) Press the select button to choose which number blinks.
- (3) Press the set button to change the blinking number.

- Press the set button repeatedly until the desired number is set.

- (1) Repeat steps (2) and (3) until the year, month, and day are all correct.

- (2) Press the select button again after all of the numbers have been changed. The numbers will stop blinking and the "ready" symbol (-) will appear above the numbers. The camera is now ready to be used.

- If you want to change the time, press the mode button to display the day, hour, and minute.

Using the same method as was used to change the date, repeat steps (2) and (3) above to change the time.

- Press the select button after changing the time. After the ":" has started to blink, press the select button again to put the camera in the "ready" state.
- To change the seconds, first make the ":" blink, and then use the set button to adjust the seconds. Afterwards press the select button to put the camera in the "ready" state.

(Fig. B)

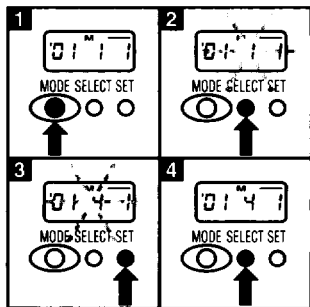

Record Mark

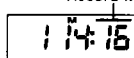

SPECIFICATIONS

Type:	35mm lens shutter camera with zoom lens and built-in flash.
Film:	35mm DX film; picture format: 24 x 36mm
Lens:	35mm /F6.3 ~ 60mm / F10.2, motor zoom lens
Shutter:	Electronically-programmed shutter
Viewfinder:	Reverse galilean albedo zoom finder; coverage:80% ± 5% Magnification: 0.49 x (35mm) ~ 0.78 x (60mm)
Flash:	Built-in flash, recharge time is 4 seconds
Flash range:	35mm (Wide): 1.2 ~ 3.2m (ISO 100) ; 1.2 ~ 6.3m (ISO 400) 60mm (Tele): 1.8 ~ 2.0m (ISO 100) ; 1.8 ~ 3.9m (ISO 400)
Photograph modes:	Functional modes: self timer, red-eye reduction Auto flash, flash on, flash off
Film transport:	Auto loading, auto advance, auto rewind (including mid-roll rewind)
Film speed:	ISO 100/200, 400 with auto setting, DX code
Self-timer:	Electronically-controlled timer, approximately 10 seconds delay
LCD panel:	Exposure counter, photograph mode, battery symbol
Power Source:	1.5V AA alkaline battery x 2
Dimensions and weight:	70.0mm (height) x 115.0mm (width) x 48.0mm (depth) (2.8" x 4.5" x 1.9") 195g / 6.9oz (without battery)

DATE MODEL

Dimensions and weight:	70.0mm (height) X 115.0mm (width) X 53.0mm (depth) (2.8" x 4.5" x 2.1") 200g / 7.1oz (without battery)
Date printing:	5 modes (Date model only)

* Design and specifications are subjected to change without notice.

WARRANTY POLICY

All Pentax cameras purchased through authorized bona fide photographic distribution channels are guaranteed against defects of material or workmanship for a period of twelve months from date of purchase. Service will be rendered, and defective parts will be replaced without cost to you within that period, provided the equipment does not show evidence of impact, sand or liquid damage, mishandling, tampering, battery or chemical corrosion, operation contrary to operating instructions, or modification by an unauthorized repair shop. The manufacturer or its authorized representatives shall not be liable for any repair or alterations except those made with its written consent and shall not be liable for damages from delay or loss of use or from other indirect or consequential damages of any kind, whether

caused by defective material or workmanship or otherwise; and it is expressly agreed that the liability of the manufacturer or its representatives under all guarantees or warranties, whether expressed or implied, is strictly limited to the replacement of parts as hereinbefore provided. No refunds will be made on repairs by non-authorized Pentax service facilities.

Procedure During 12-month Warranty Period

Any Pentax which proves defective during the 12-month warranty period should be returned to the dealer from whom you purchased the equipment or to the manufacturer. If there is no representatives of the manufacturer in your country, send the equipment to the manufacturer, with postage prepaid. In this case, it will take a considerable length of time before

the equipment can be returned to you owing to the complicated customs procedures required. If the equipment is covered by warranty, repairs will be made and parts replaced free of charge, and the equipment will be returned to you upon completion of servicing. If the equipment is not covered by warranty, regular charges of the manufacturer or of its representatives will apply. Shipping charges are to be borne by the owner. If your Pentax was purchased outside of the country where you wish to have it serviced during the warranty period, regular handling and servicing fees may be charged by the manufacturer's representatives in that country. Notwithstanding this, your Pentax returned to the manufacturer will be serviced free of charge according to this procedure and warranty policy.

In any case, however, shipping charges and customs clearance fees to be borne by the sender. To prove the date of your purchase

when required, please keep the receipt or bills covering the purchase of your equipment for at least a year. Before sending your equipment for servicing, please make sure that you are sending it to the manufacturer's authorized representatives or their approved repair shops, unless you are sending it directly to the manufacturer. Always obtain a quotation for the service charge, and only after you accept the quoted service charge, instruct the service station to proceed with the servicing.

The local warranty policies available from Pentax distributors in some countries can supersede this warranty policy. Therefore, we recommend that you review the warranty card supplied with your product at the time of purchase, or contact the PENTAX distributor in your country for more information and to receive a copy of the warranty policy.

MEMO

MEMO



Asahi Optical Co.,Ltd. 36-9 Maeno-cho 2-chome, Itabashi-ku, Tokyo 174-8639, JAPAN (<http://www.pentax.co.jp/>)
Pentax GmbH (European Headquarters) Julius-Vosseler-Strasse 104, 22527 Hamburg, GERMANY
(<http://www.pentax.de/>)
Pentax U.K. Limited Pentax House, Heron Drive, Langley, Slough Berks SL3 8PN, U.K. (<http://www.pentax.co.uk/>)
Pentax FRANCE S.A. 12/14, rue Jean Poulmarch, 95100 Argenteuil, FRANCE
Pentax Benelux B.V. (for Netherlands) Spinveld 25, 4815 HR Breda, NETHERLANDS (<http://www.pentax.nl/>)
(for Belgium & Luxemburg) Weiveldlaan 3-5, 1930 Zaventem, BELGIUM (<http://www.pentax.be/>)
Pentax (Schweiz) AG Industriestraße 2, 8305 Dietlikon, SWITZERLAND (<http://www.pentax.ch/>)
Pentax Scandinavia AB P.O. Box 650, 75127 Uppsala, SWEDEN (<http://www.pentax.se/>)
Pentax Europe n.v. (European Distribution Centre) Weiveldlaan 3-5, 1930 Zaventem, BELGIUM
Pentax Corporation 35 Inverness Drive East, Englewood, Colorado 80112, U.S.A (<http://www.pentax.com/>)
Pentax Canada Inc. 3131 Universal Drive, Mississauga, Ontario L4X 2E5, CANADA