

**PENTAX**

**auto 110 SUPER**

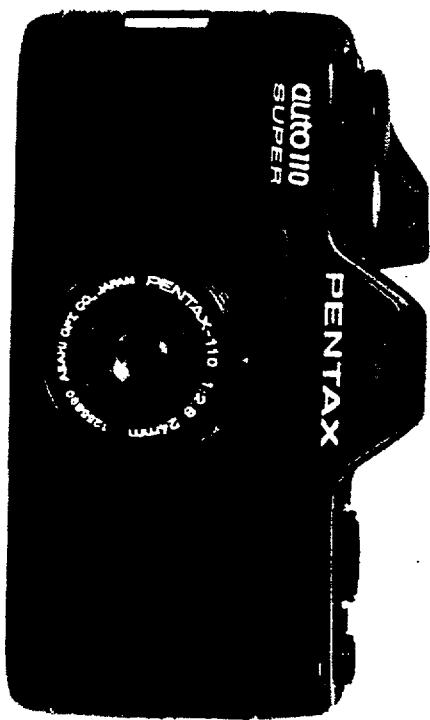

# THE PENTAX AUTO 110 SUPER SYSTEM

The Pentax Auto 110 Super is an extremely light and portable camera that can be tucked neatly into a pocket or carried in the palm of the hand for unsurpassed picture taking ease. The Auto 110 Super is an SLR (Single-lens-reflex) camera that uses 110 cartridge film. It combines the convenient size and easy loading of the 110 format with the technical advantages of the SLR lens system. The advanced and fashionable design of the Auto 110 Super will provide unlimited enjoyment and enable quick and easy, foolproof picture taking—anytime, anywhere.

## CONTENTS

Specifications .....	2	Changing lenses .....	25
Names of parts .....	4	Using the PF (panfocus) lens .....	26
Basic operating instructions .....	6	Exposure compensation .....	28
Shutter mode selector .....	11	Self-timer .....	29
Battery loading .....	12	Aperture and shutter speed relationship ..	30
Battery life .....	14	Lenses available .....	32
Battery precautions .....	15	Auto flash units .....	34
Film loading .....	16	110 Winder II/Other accessories .....	35
Advancing the film .....	17	Using tripod .....	36
Focusing .....	18	Corrective eyepieces .....	37
Exposure check .....	20	Using the handstrap and soft case .....	38
Holding the camera .....	22	Handling precautions .....	39
At the end of the roll .....	24	Warranty policy .....	40

## SPECIFICATIONS

Type	TTL metering 110 AE SLR camera with bayonet mount for interchangeable lenses.
Film Type	Cartridge-loading 110 film.
Negative Format	13mm x 17mm.
Lens	Pentax-110 24mm f/2.8; 47-degree angle of view; 25.5mm filter threads. Focusing Range: 0.35m-∞.
Lens Mount	110 bayonet mount; 80-degree setting angle.
Viewfinder	Eye-level pentaprism finder with quick-return mirror.
Focusing	Central split-image focusing spot surrounded by microp prism collar in matte field.
Viewfinder Information	Green LED indicates adequate shutter speed (minimum of 1/45 sec. at f/2.8); yellow LED indicates slow shutter speed (less than 1/45 sec.) requiring use of tripod or auto flash to avoid camera shake.
Battery Check	Magnification: 0.75X showing 87% of the picture area. Viewfinder LEDs fail to light on depressing shutter button when batteries are low.
Exposure Metering	Center-weighted, TTL metering at full aperture via SPD cell. EV Range from 3 (approx. 1 sec. at f/2.8) to 17 (approx. 1/400 sec. at f/18) with ISO/ASA 100 film.
Film Speed Setting	An exposure compensation value of +1.5EV (3X aperture value) is possible by pressing the exposure compensation button located on the front of the camera.
Shutter	Automatic set for available 110-cartridge films.
Self-Timer	Programmed electronic behind-the-lens shutter. Built-in electronic self-timer with interrupt function. Releases shutter in 10 seconds.
Shutter/Aperture Range	1/400 sec. at f/18 - 1 sec. at f/2.8 with ISO/ASA 100.
Film Advance	Single 144-degree stroke of film advance lever advances film a single frame; 55-degree pre-advance setting.
Exposure Counter	Frame number appears in back cover window.
Other Features	Automatic flash synch with AF 130P or AF 100P at 1/60 sec. and f/2.8 with ISO/ASA 100 film; at 1/125 sec. and f/5.6 with ISO/ASA 400 film, tripod socket, lens release button, wrist strap hook, battery holder, winder capability, etc.
Power Source	Two 1.5V alkaline (LR44) or silver-oxide (SR44) batteries.
Dimensions	With 24mm f/2.8 lens: 99mm(W) x 58mm(H) x 46mm(D)
Weight	With 24mm f/2.8 lens: 178g (6.3 ozs.) less batteries.

# NAMES OF PARTS

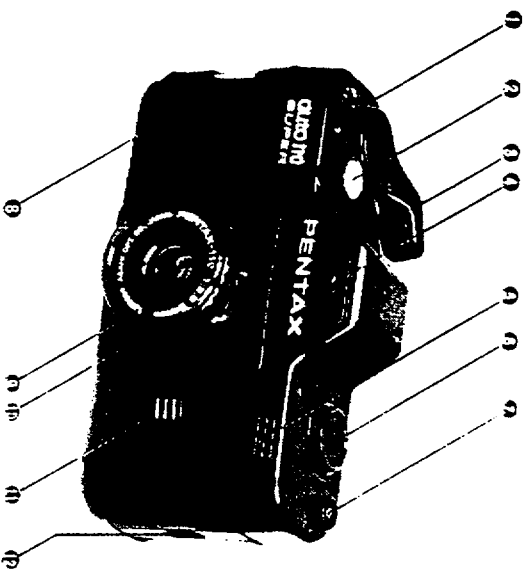

- 1 Shutter mode selector
- 2 Shutter release button
- 3 Film advance lever
- 4 Self-timer operation indicator
- 5 Exposure compensation button
- 6 Flash synch-shoe cap
- 7 Flash contact pin
- 8 Wrist strap hook
- 9 Focusing ring
- 10 Distance scale Index
- 11 Lens release button
- 12 Back cover release
- 13 Shutter/mirror box module
- 14 Viewfinder eyepiece
- 15 Film cartridge chamber
- 16 Battery holder
- 17 Back cover window
- 18 Winder contact terminals
- 19 Film cartridge chamber
- 20 Film drive coupler
- 21 Tripod socket

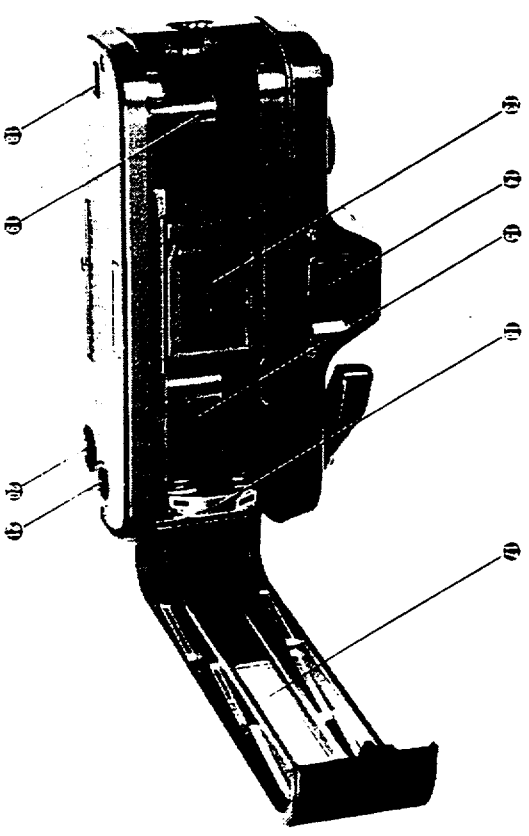

## BASIC OPERATING INSTRUCTIONS

For details, refer to the appropriate section of this manual.

1. Set the shutter mode selector to the "A" (Automatic) position.

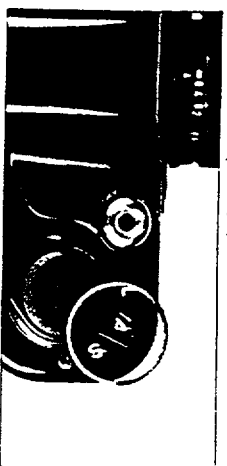

2. Open back cover.



3. Remove battery holder.

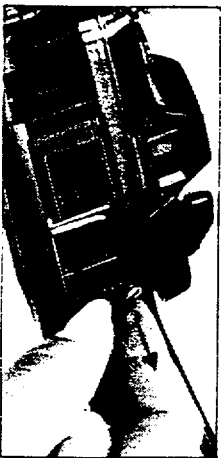

4. Insert batteries and return holder to original position.



5. Insert film (110 cartridge).



6. Turn film advance lever approx. 4 strokes until it stops.

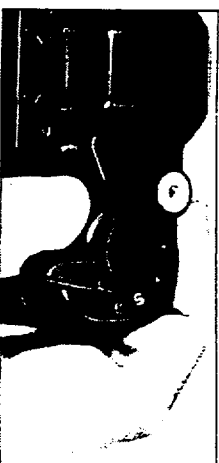

7. The numeral "1" will appear in the back cover window.

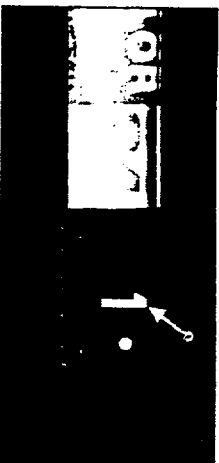

8. Turn focusing ring.



10. Steps 7 & 8 do not apply when using the PF lens.



9. Focus.



11. Confirm a green light appears in the viewfinder when you depress the shutter button halfway.

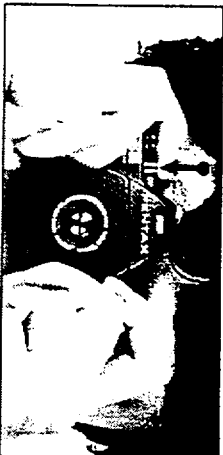

12. Then, gently press the button all the way and take the photograph.

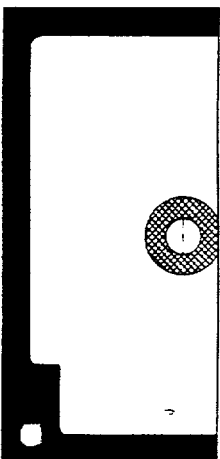

13. Turn film advance lever for next exposure.

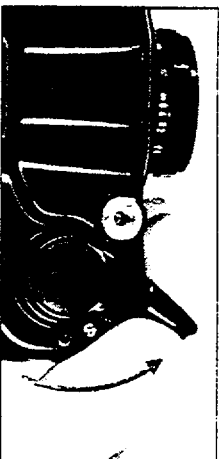

14. The end of the roll has been reached when an "X" appears in the back cover window.

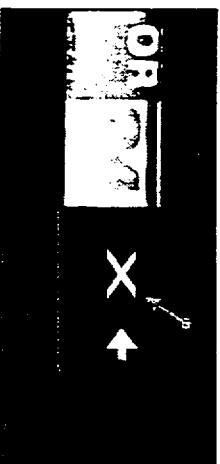

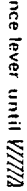
15. Turn the film advance lever until  appears, then remove the film cartridge.

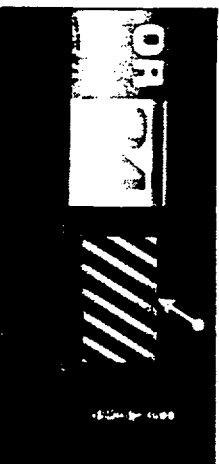

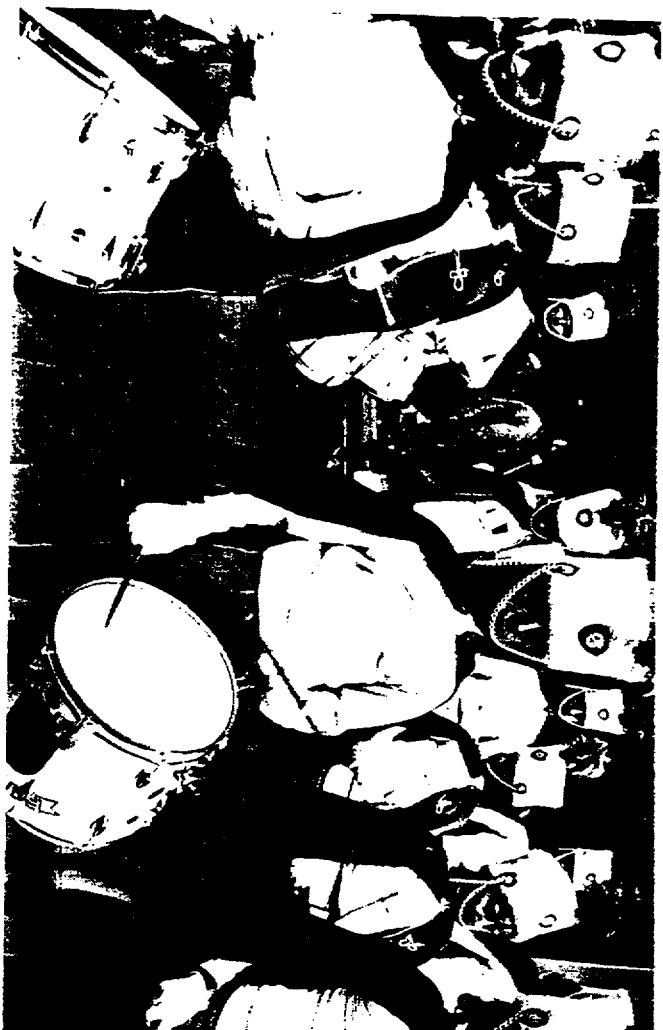

## SHUTTER MODE SELECTOR

"A" stands for automatic shutter or automatic exposure. Always set the shutter mode selector at "A" for normal shooting.

"L" stands for shutter button lock.

Once set, the shutter is not released even if you depress the shutter button.

"S" stands for self-timer. For the self-timer operation, refer to page 29.

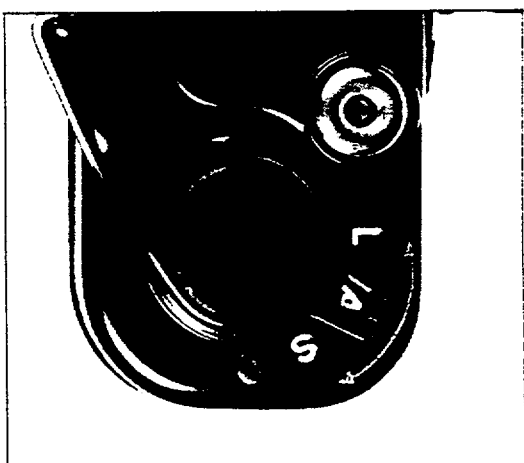

## BATTERY LOADING

1. Push down the back cover release, open the back cover and remove the battery holder from inside the battery chamber.
2. Insert the (+) side of one of the batteries into the opened side of the holder. Then, turn the holder over and do the same with the other battery. The (-) side of both batteries will correspond with the (-) indication on top of the holder when inserted properly.

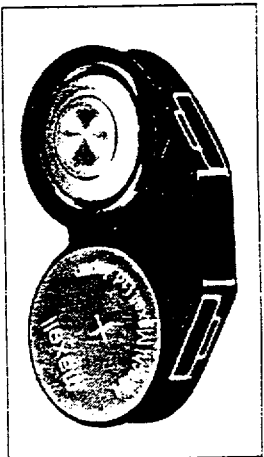
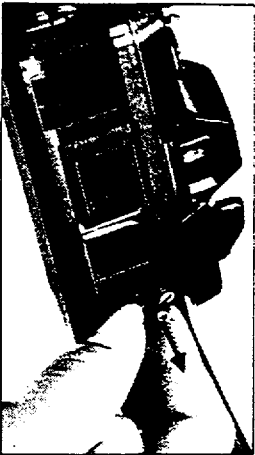

3. Insert the loaded holder — curved-side first—back into the battery chamber. Proper contact will be made no matter which battery is on top as long as batteries have been inserted into the holder properly.

The Auto 110 Super does not use manual shutter operation. The camera must be loaded with batteries for the shutter and "AE" function to operate. Before taking pictures, always check the condition of the batteries by looking at the LED indicators in the camera viewfinder



## BATTERY LIFE

Under normal usage, one set of Alkaline batteries will last about one year. If batteries are inserted improperly, or if they have become worn, the LED indicator lamps in the viewfinder will fail to light when you depress the shutter release halfway. Should batteries require replacement, replace BOTH at the same time with equivalent 1.5V Alkaline or Silver-oxide batteries.

If the shutter mode selector is at the "L" position when checking the batteries, no LED lamps will light.

14

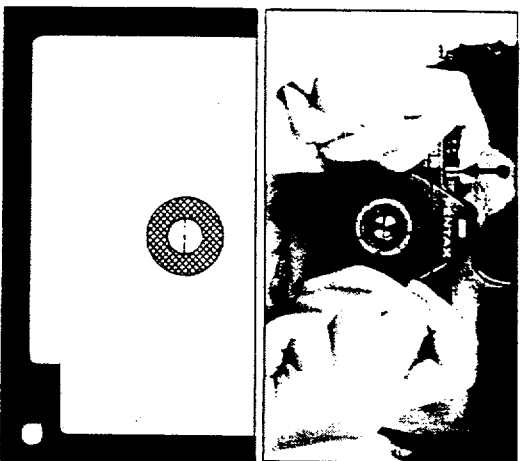

## BATTERY PRECAUTIONS

Remove the batteries from the camera if you will not be using it for a long time.

Do not take apart or charge a dead battery, or throw it into a fire, as it may explode. Always keep the batteries out of the reach of infants.

**N.B.:** If the batteries go dead while there is film in the camera, first wind the film, then, point the lens, downward and open the back cover in a shaded location to avoid possible light leakage, then remove the battery case and replace the batteries, taking care not to move the film cartridge. Close the back cover, and be sure to wind the film again before start shooting.

15

## FILM LOADING

1. Insert the film cartridge as shown.
  2. Close the back cover.
- The 110 cartridge film automatically adjusts the camera to the correct ISO/ASA speed (ISO/ASA 64/100 or ISO/ASA 400) upon loading. No manual film speed setting is required.
- ISO/ASA 400 film is appropriate for photographing dark subjects or when you desire a fast shutter speed. Otherwise, we recommend ISO/ASA 64 or 100.



## ADVANCING THE FILM

Turn the film advance lever about 4 times until the numeral "1" appears in the back cover window. You are now ready to take your first picture. After each exposure, turn the film advance lever to cock the shutter for the next exposure. You may also use a winder to advance the film (see page 35).

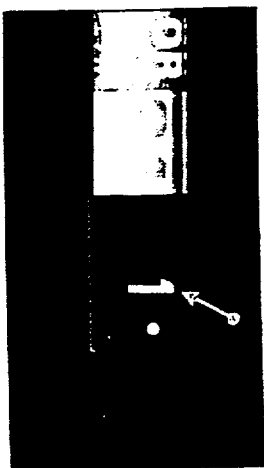

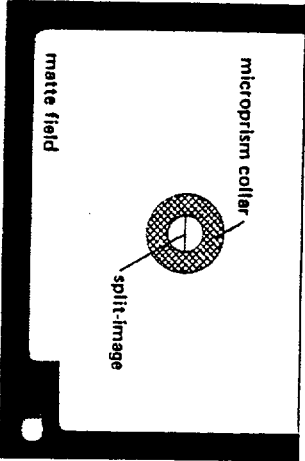

Look through the eyepiece and turn the focusing ring of the lens. Reasonably sharp focus can be obtained by focusing on any part of the screen. However, to insure pinpoint focusing, check your focus against the split-image center spot in the middle of the screen which is composed of a split-image and a microprism collar. Precise focus is indicated when the two halves of the split-image are completely aligned, and the microprism collar area does not glitter. If the image is split, turn the focusing ring further until both halves of the image align perfectly. Or, if the microprism image surrounding the

split-image appears to glitter or be fragmented, likewise, adjust the focus ring until fragmentation and glitter disappear.

When focusing, be careful to position your eye at a right angle to the center of the viewfinder so as to avoid darkening of the split-image or microprism. Otherwise, this could make it difficult to accurately focus. For those who find focusing difficult because of poor eyesight, corrective eyepieces are available (see page 37).

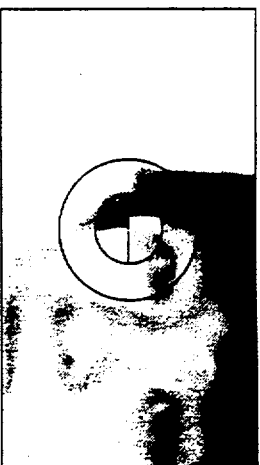

## EXPOSURE CHECK

Set the shutter mode selector to the "A" (Automatic) position.

It is possible to shoot with the camera held in your hands when the green LED lights up in the lower right corner of the viewfinder when you depress the shutter release button halfway. If the subject to be photographed is dark and the yellow LED flickers, the shutter speed will be slower, so you should use either a tripod or one of the Auto Flashes (AF 100P or AF130P) to prevent blurring.

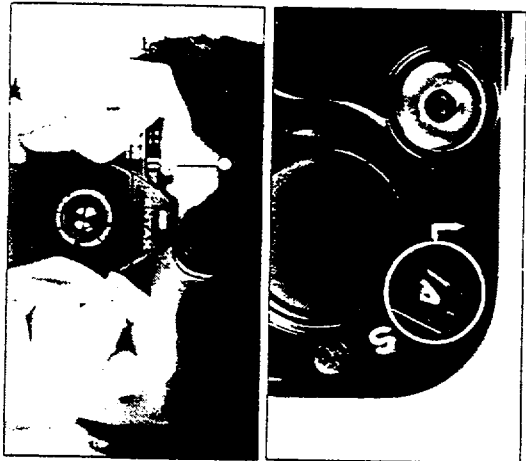

## HOLDING THE CAMERA

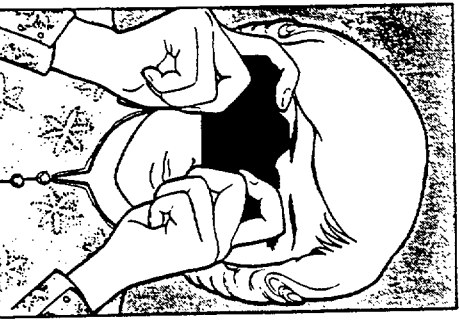

1. Horizontal position



2. Vertical position  
(shutter release button on top)

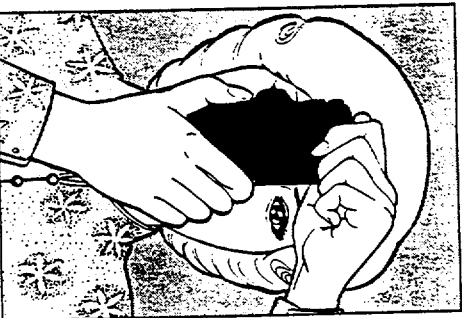

3. Vertical position  
(shutter release button at bottom)

It is important to hold the camera properly in order to take blur-free photos. Practice holding and operating the camera before inserting your first film cartridge.

The photos (see p. 22) show the basic holding positions. No matter which position you use, be sure to grip the camera steadily with both hands, hold the camera gently against the face in a fixed position, and relax the rest of your body in a secure posture. Brace the elbow of the arm supporting the camera against your body. You may also use a tree or building, etc. as support. Always push the shutter release button gently.

**CAUTION:** Do not touch the flash contact pin with your finger when holding the camera. If you do, the shutter speed will be automatically set at approx. 1/60 sec. with ISO/ASA 100 film, and an incorrect exposure may result.



## AT THE END OF THE ROLL

When nearing the end of the film roll (12 or 24 exposures), be sure to check the film window. An "X" will appear when you advance the film after using the last exposure on the roll. After that, although the shutter can be released, no photograph will be taken.

Advance the film approximately 3 exposures' worth past "X," until  appears and the film stops. Do not attempt to force the film to advance any further.

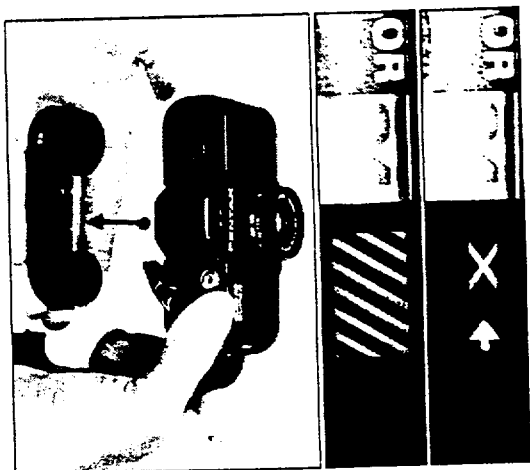

Open the back cover and remove the film for processing.



## CHANGING LENSES

### LENS REMOVAL

Push upwards on the lens release lever and turn the lens approximately 90 degrees to the left until the lens slips out of the mount.

1. Match up the red distance scale index of the lens  with the red dot on the camera body  and insert the lens into the body.
2. Turn the lens to the right until it locks in place, with the red distance scale index positioned at the top.

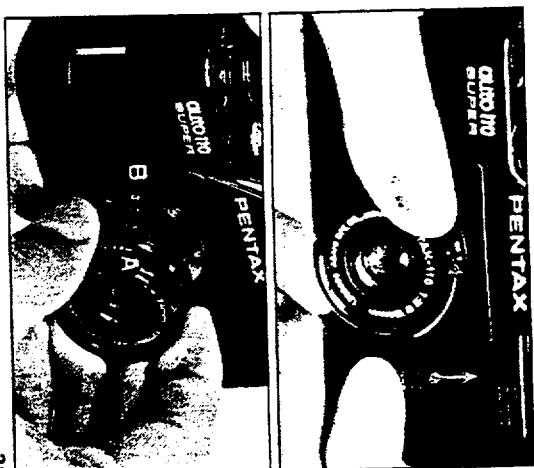

## USING THE PF (PAN FOCUS) LENS

The pan-focus lens allows you to take photos without focusing. Simply look through the viewfinder, frame your subject and then press the shutter release. Depending on the distance to the subject, there may be a slight split in the center circle in the viewfinder,



but if the subject is at least 1.75m away, the entire photo will always be in focus because of the deep range of focus of this lens.

There will be some variation in the actual effective range of focus, depending on the brightness of the subject, as follows:

Conditions	Effective Range
------------	-----------------

Outdoors Clear	approx. 1m ~ ∞
----------------	----------------

Outdoors Cloudy	approx. 1.5m ~ ∞
-----------------	------------------

When the yellow LED flickers in the viewfinder, take precautions against camera movement.

### Using the Close up attachment

You can take extreme close-up photographs by screwing on a Close-up Attachment W21 (optional) into the filter thread. Because this is a fixed-focus lens, you can take photographs only at a preset distance of approx. 25cm between the subject and the film plane, i.e., when the focusing image is aligned. Extreme close-up photos cannot be taken at other distances.

Magnification: 1/11.3 times.

Size of framed target area:

14.7 x 19.2mm.

The PF lens accepts filters and a lens hood with a 30.5mm diameter.

### Using an auto flash unit

When using an Auto Flash with the PF lens, refer to the chart below for effective flash range.

Film	Auto Flash	Effective Range
ASA 100	AF100P	approx. 2m ~ 3.5m
	AF130P	approx. 2m ~ 4.6m
ASA 400	AF100P	approx. 1.4m ~ 3.5m
	AF130P	approx. 1.4m ~ 4.6m

## EXPOSURE COMPENSATION

### Exposure Compensation Button

In conditions of strong background light, for example, when the subject is outlined against a bright sky or intense artificial light, there is a danger of the subject being underexposed. To avoid this problem, release the shutter while keeping the exposure compensation button depressed. This will compensate for the background light and provide an appropriate exposure level to the main subject.

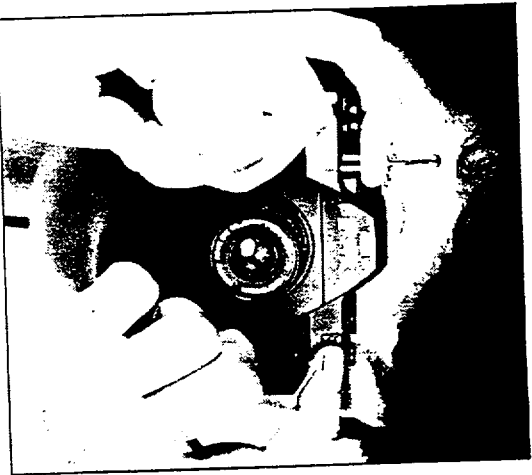

## SELF-TIMER

The built-in self-timer delays shutter release for 10 seconds; can be used for self portraits or group photographs which include the photographer. Setting the timer is quite simple. First set the shutter mode selector to the "S" position. Then, press the shutter release button. During the self-timer operation, always use the accessory eyepiece cup to avoid adverse light coming into the viewfinder. While the timer is operating, the easy-to-see LED indicator on the pentaprism housing will flicker. The flickering speed will increase during the last two seconds of timer operation to indicate approaching shutter release.

If it is necessary to stop timer operation at any point, merely move the shutter mode selector to the "A" position which will automatically switch the timer circuit to normal status.

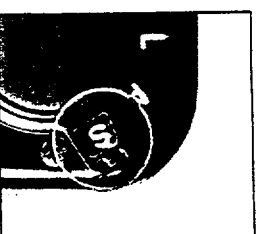



## APERTURE AND SHUTTER SPEED RELATIONSHIP

The Auto 110 Super's automatic exposure system is based on a program that has apertures and shutter speeds paired off in preset combinations.

Neither aperture nor shutter speed is displayed on the camera. However, when the green LED lights up in the viewfinder the speed is 1/45 second or faster, and the aperture is f/2.8 or smaller. If the yellow LED flickers, the aperture is f/2.8 and the shutter speed is 1/45 sec. or slower.

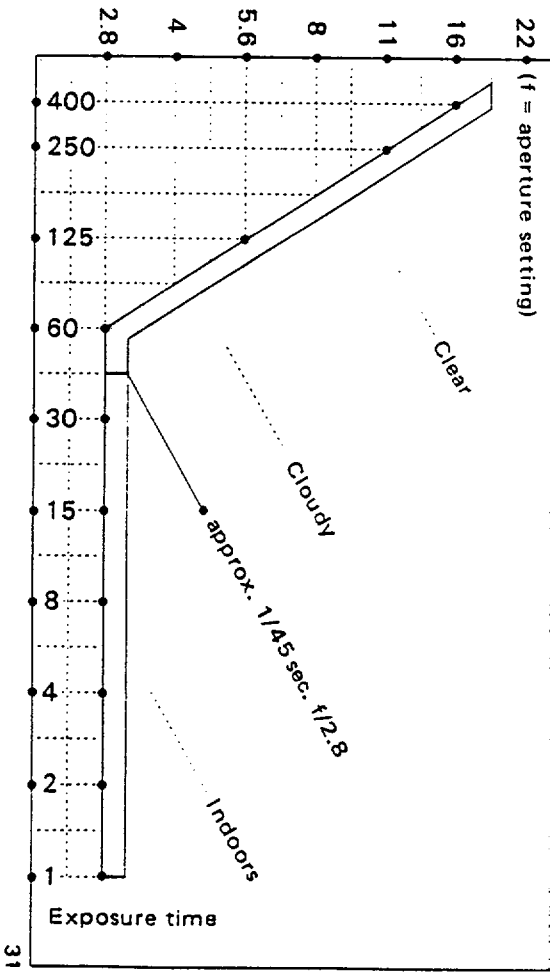

## LENSES AVAILABLE

A total of six lenses are available — the standard 24mm lens, an 18mm wide-angle lens, 50mm and 70mm telephoto lenses, the PF 18mm fixed-focus lens, and a 20—40mm zoom lens.

All Pentax 110 lenses are bayonet-mounted, and all of them accept filters, close-up attachments, and lens hoods. (see pg. 35 "Accessories") The filter thread diameter of the 70mm telephoto and the 20—40mm

zoom lenses is 49mm, so lens accessories made for 35mm format cameras can be screwed in.

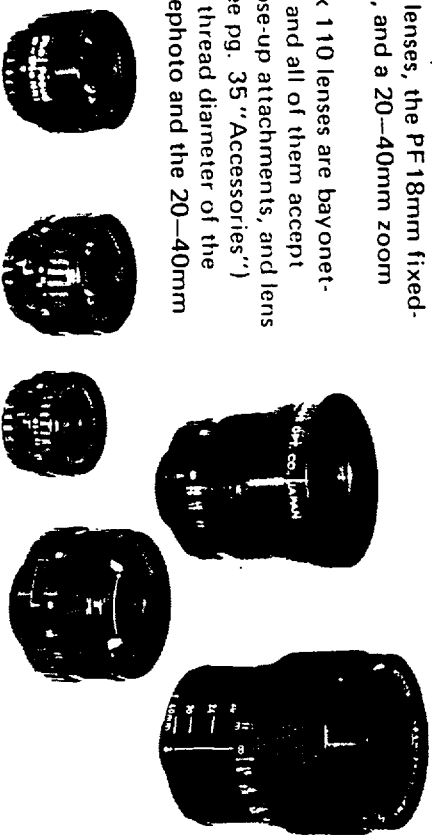

Type	Focal length	Lens construction (Groups—Elements)	Angle of view (Degrees)	Minimum focusing (m)	Diameter & length (mm)	Filter size (mm)	Weight (gr.)
Standard	24mm	5-6	47	0.35	30 x 13	25.5	13
Wide-angle	18mm	6-6	61.5	0.25	34 x 21	30.5	27
Telephoto	50mm	5-5	24	0.9	43 x 27	37.5	57
Telephoto	70mm	5-6	17.2	1.5	51 x 50.5	49	160
PF	18mm	6-6	61.5	—	34 x 21	30.5	29
Zoom	20—40mm	8-8	57.5—31	0.7	54 x 45.2—65.4	49	174

Note: ● PF is a fixed-focus lens.

● There are no aperture settings on Pentax-110 lenses. The aperture is set automatically by the diaphragm mechanism of the camera's programmed shutter system. The aperture range is f/2.8 — f/13.5.

## AUTO FLASH UNITS

Auto Flash units are available in two models — AF130P and AF100P. When using ISO/ASA 100/400 film, you may photograph subjects at the following distances by simply focusing — a subject between 0.8 ~ 4.6 meters from the camera using the AF130P Auto Flash, and a subject 0.8 ~ 3.5 meters away using the AF100P Auto Flash. However, the flash cannot be used if the green LED is lit up in the viewfinder, as when the room is very bright.

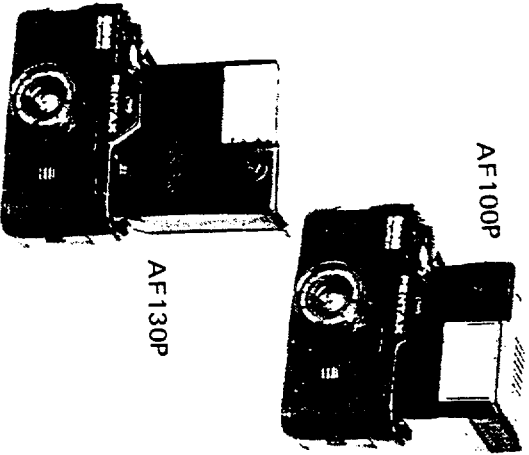

## 110 WINDER II

This convenient winder automatically advances the film to Exposure 1 and continues advancing the film at the rate of 1 frame per second until the roll is finished.



## OTHER ACCESSORIES

- 110 Close-up attachments
- S31, S16 (for use with 24mm lens)
- W21 (for 18mm lens)
- T86, T43 (for 50mm lens)
- 110-1100 (11V battery)
- 25.5mm (for use with 24mm lens)
- 30.5mm (for 18mm lens)
- 37.5mm (for 50mm lens)

### Hoods

There is a specially-designed hood for each 110 lens.  
N.R.: As the filter thread of the 70mm and 20-40mm zoom lenses is 49mm in diameter, 49mm filters, close-up attachments, and lens hoods made for 35mm format cameras can be used.

## USING A TRIPOD

A tripod can be screwed into the tripod socket. When using the 50mm or 70mm telephoto lens or the 20-40mm zoom lens, the lens will hit the tripod mount. To correct this, screw the accessory tripod spacer onto the tripod mount before affixing the camera.

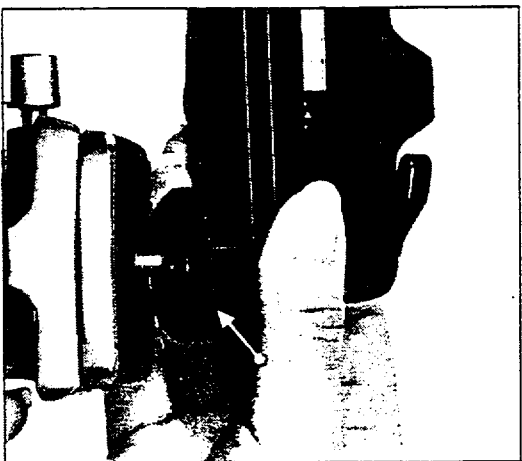

## CORRECTIVE EYEPieces

Corrective eyepieces can be mounted on the viewfinder window by inserting over the accessory grooves. These are available in the following diopters: -5, -4, -3, -2, -1, +1, +2 and +3. When purchasing a corrective eyepiece, make certain it is the right one by testing it on a camera.

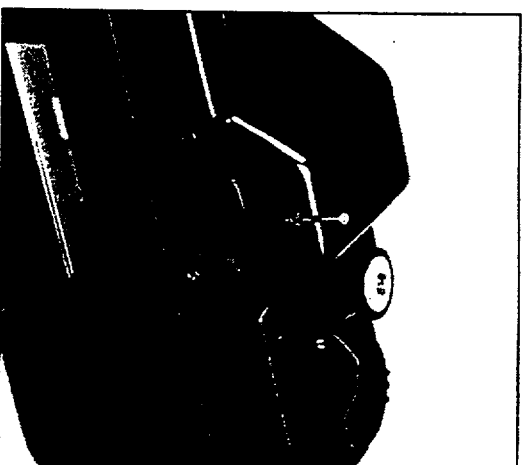

## USING THE HANDSTRAP AND SOFT CASE

1. Attach the handstrap by pushing the clip towards you from its front.
2. To remove, push the clip in the direction of the arrow imprinted on it while wiggling it right and left.
3. You may use the handstrap by letting it hang outside the soft case through the hole on the left.

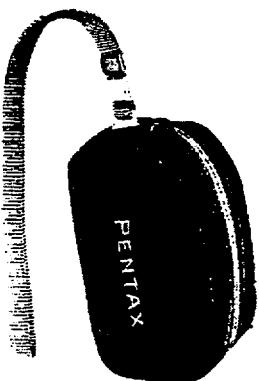
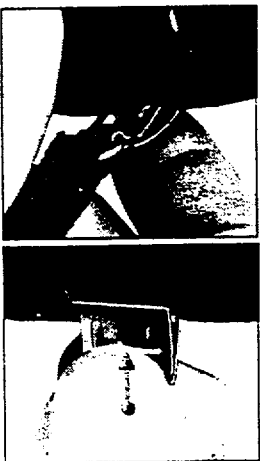

## HANDLING PRECAUTIONS

Take care not to drop the camera or knock it against anything solid. Do not store it in a place with high temperature and humidity. Be aware that the inside of an automobile often becomes extremely hot. Do not store the camera in a drawer with mothballs or similar products as they may damage the camera or film. Do not wipe the camera or lens with solvents such as paint thinner or alcohol to clean. Use a blower to blow away dust from the lens and other glass surfaces, and then clean with a lens brush.

### Precaution on Auto 110 Super Lens Removal

When changing lenses or removing the lens on the camera, slide the lens release button upward and, without letting go, turn the lens counterclockwise until it slips out of the mount. Never attempt to remove a lens without first unlocking the mount by sliding the lens release button upward, as damage to the mount could result.

## WARRANTY POLICY

All Pentax cameras purchased through authorized bona fide photographic distribution channels are guaranteed against defects of material or workmanship for a period of twelve months from date of purchase.

Service will be rendered and defective parts will be replaced without cost to you within that period, provided the equipment has not been abused, altered, or operated contrary to instruction. Because the tolerances, quality, and design compatibility of lenses other than Pentax lenses are beyond our control, damage caused by use of such lenses will not be covered by this warranty policy. The manufacturer or its authorized representatives shall not be liable for any repair or alternations except those made with its written consent and shall not be liable for damages from delay or loss of use or from other indirect or consequential damages of any kind, whether caused by defective material or workmanship or

otherwise; and it is expressly agreed that the liability of the manufacturer or its representatives under all guarantees or warranties, whether expressed or implied, is strictly limited to the replacement of parts as hereinbefore provided.

### Procedure During 12-month

#### Warranty Period

Any Pentax which proves defective during the 12-month warranty period should be returned to the dealer from whom you purchased the equipment or to the manufacturer. If there is no representative of the manufacturer in your country, send the equipment to the manufacturer, with postage prepaid. In this case, it will take a considerable length of time before the equipment can be returned to you owing to the complicated customs procedures required in Japan in importing and re-exporting photographic equipment. If the equip-

ment is covered by warranty, repairs will be made and parts replaced free of charge, and the equipment will be returned to you upon completion of servicing. If the equipment is not covered by warranty, regular charges of the manufacturer or of its representatives will apply. Shipping charges are to be borne by the owner. If your Pentax was purchased outside of the country where you wish to have serviced during the warranty period, regular handling and servicing fees may be charged by the manufacturer's representatives in that country. Notwithstanding this, your Pentax returned to the manufacturer will be serviced free of charge according to this procedure and warranty policy. In any case, however, shipping charges and customs clearance fees are to be borne by the sender. To prove the date of your purchase when required, please keep the receipts or bills covering the purchase of your equipment for at least a year. Before

sending your equipment for servicing, please make sure that you are sending it to the manufacturer's authorized representatives or their accredited repair shops, unless you are sending it directly to the manufacturer. Always obtain a quotation of the service charge, and only after you accept the quoted service charge, instruct the service station to proceed with the servicing.

This warranty policy does not apply to Pentax products purchased in the U.S.A., U.K., or Canada. The local warranty policies available from Pentax distributors in those countries supersede this warranty policy.



Asahi Optical Co., Ltd. C.P.O. 895, Tokyo 100-91, JAPAN  
Asahi Optical Europe N.V. Weverdijkm 3.5, 1930 Zaventem Zuid-7, BELGIUM  
Pentax Handelsgesellschaft mbH, 2000 Hamburg 54 (Lokstedt), Grönberg 64, WEST GERMANY  
Pentax U.K. Limited Pentax House, South Hill Avenue, South Harrow, Middlesex HA2 0LT, U.K.  
Pentax France S.A. 72-76 Rue Paul Vaillant Couturier, 92300 Levallois Perret, FRANCE  
Pentax Nederland Spineveld 25, 4815 HR Breda, THE NETHERLANDS  
Pentax (Schweiz) AG Industriestrasse 2, 8305 Dietlikon ZH, SWITZERLAND  
Pentax Svenska AB Hornsgatan 50A, 11721 Stockholm, SWEDEN  
Pentax Corporation 35 Inverness Drive East, Englewood, Colorado 80112, U.S.A.  
Pentax Canada Inc. 1760 West 3rd Avenue, Vancouver, B.C. V6J 1K5, CANADA  
Asahi Optical Brasileira Ind. e Com. Ltda. Rua Estados Unidos, 1053, São Paulo-SP, BRAZIL

06651 ENG

Specifications are subject to change without notice.

3/83 Printed in Japan