

PENTAX®

OPERATING MANUAL

IQZoom115M

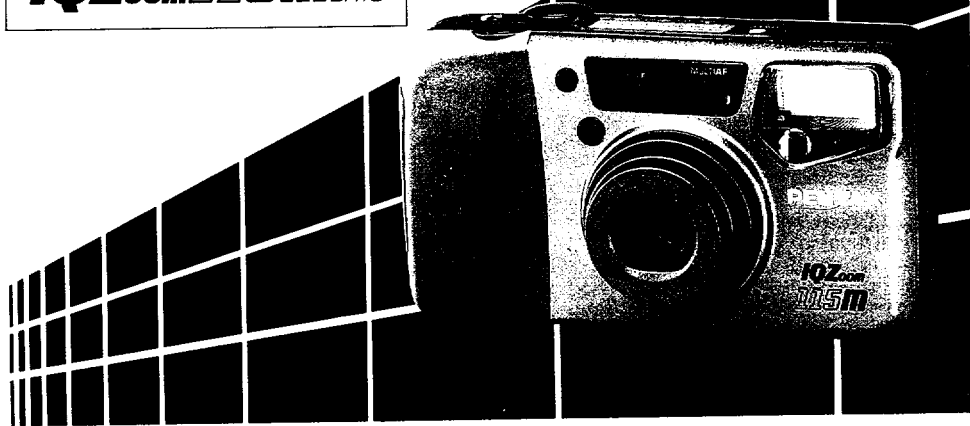





IQZoom115M DATE



Congratulations on your purchase of the PENTAX IQ ZOOM 115M and welcome to the world of Pentax zoom compact photography! Your compact, light weight camera is a great companion to preserve your favorite memories. Its built-in 38-115mm lens gives you the freedom to frame everything from breathtaking landscapes to family portraits, even detailed close-ups. The built-in auto flash helps you capture subjects in dimly-lit places or photograph indoor scenes with clarity and brilliance. Also included are panorama/standard format mid-roll switching capability and a wireless remote control feature. Since most of the operation - including film loading, film speed setting, winding/rewinding, focus and exposure control - are automatic, you can take great pictures effortlessly.

- Please read this manual carefully before operating the camera to take consistently superior pictures.
- Pay special attention to the cautions and notes in this Operating Manual. Pictures and illustrations shown herein may differ from the camera's actual appearance.
- Illustrations in this operating manual are the DATA MODEL.

Icon indicators used in this manual

Operation direction	
Automatic operation	
Attention	
Lamp lighted	
Lamp blinking	
Correct	
Incorrect	

The name of the camera's working parts are listed on the front and back flaps of this manual. Keep the flaps unfolded for quick reference while reading the manual.



NAMES OF WORKING PARTS |

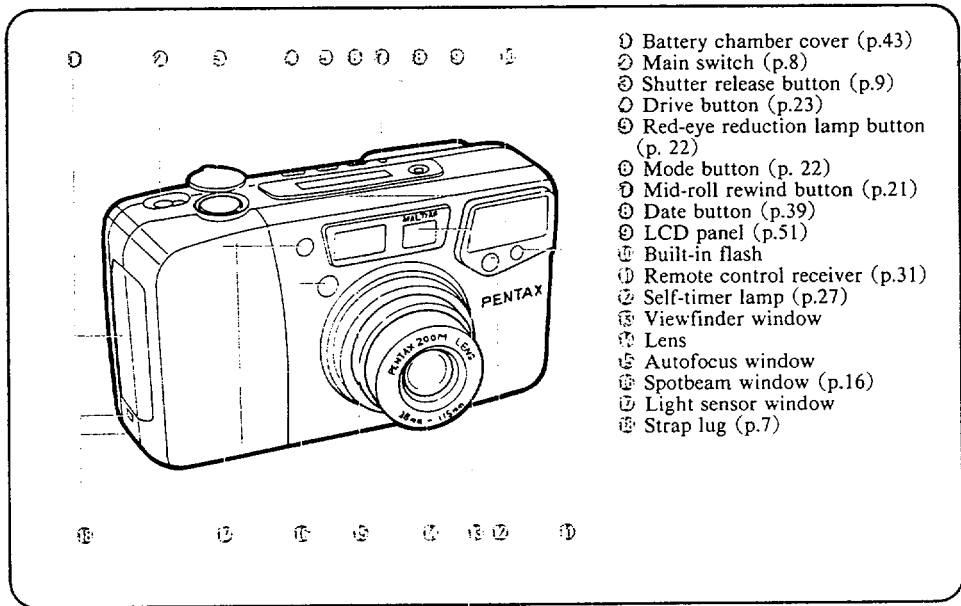

- ① Battery chamber cover (p.43)
- ② Main switch (p.8)
- ③ Shutter release button (p.9)
- ④ Drive button (p.23)
- ⑤ Red-eye reduction lamp button (p. 22)
- ⑥ Mode button (p. 22)
- ⑦ Mid-roll rewind button (p.21)
- ⑧ Date button (p.39)
- ⑨ LCD panel (p.51)
- ⑩ Built-in flash
- ⑪ Remote control receiver (p.31)
- ⑫ Self-timer lamp (p.27)
- ⑬ Viewfinder window
- ⑭ Lens
- ⑮ Autofocus window
- ⑯ Spotbeam window (p.16)
- ⑰ Light sensor window
- ⑱ Strap lug (p.7)

OUTLINE OF BASIC OPERATIONS

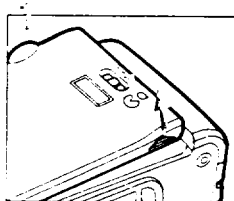

Open the back cover (see page 11).

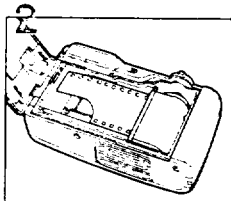

Load the film and close the back cover (see page 12).

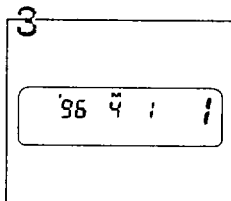

The film will automatically advance to the first frame (see page 13).

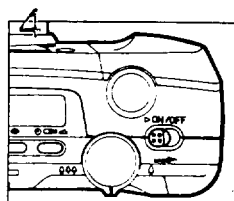

Switch on power (see page 8).

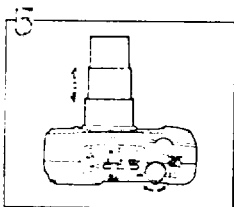

Frame your subject and operate the zoom lever to compose the shot (see page 10).

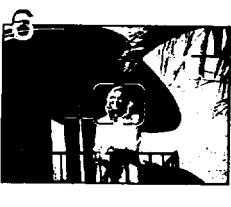

Focus on your subject (see page 17).

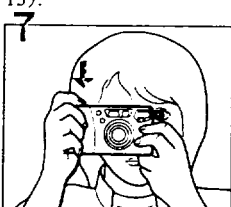

Depress the shutter release button. In dark conditions, the flash will discharge automatically (see page 19).

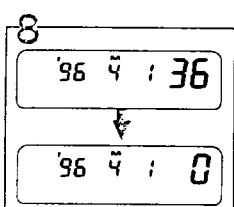

When the film is finished, the camera will automatically rewind it (see page 20).

FOR SAFE USE OF YOUR CAMERA

Although we have carefully designed this camera for safe operation, please be sure to follow precautions given in this page.



WARNING

This mark indicates precautions that if not followed, could result in serious injury to the operator.



CAUTION

This mark indicates precautions that, if not followed, could result in minor or medium injury to the operator or damage to the equipment.



WARNING

- The electric circuits inside the camera contain high voltage working parts. Never attempt to disassemble the camera yourself.
- Never touch internal parts of the camera if they become exposed from dropping the camera or for some other reason, as there is danger of electric shock.
- Be sure to store batteries out of the reach of children. Seek medical assistance immediately if accidentally swallowed.



CAUTION

- Do not use the flash near anyone's eyes, as it may hurt them. Be particularly careful with the flash around infants.
- Never try to disassemble, short or recharge the battery. Also, do not dispose of the battery in fire, as it may explode.
- Remove the battery from the camera immediately if it becomes hot or begin to smoke. Be careful not to burn yourself during removal.

PRECAUTIONS FOR YOUR CAMERA

Precautions when taking pictures

- Do not use the camera where it may come in contact with rain, water or any other liquid, because the camera is not weather, water, or liquid resistant. Should the camera get wet from rain, splashing water, or any other liquid, wipe it off immediately with a dry soft cloth.
- Do not drop the camera or allow it to hit a solid object. If the camera suffers a severe shock or impact, take it to a Pentax service center for inspection.
- Be careful not to subject the camera to strong vibrations, shock or pressure. Use a cushion to protect the camera when carrying it in a motorcycle, car, boat, etc.
- Condensation on the interior or the exterior of the camera may be extremely harmful to the camera mechanism as it may cause rust. Furthermore, if the camera is taken from warm temperature to a subfreezing one or vice versa, the formation of icelets may cause damage. In such a case, put the camera into a case or plastic bag so that any changes in temperature difference is minimized. Do not remove it from the bag until temperature has stabilized.

- Regular size color prints may cut off what appears on the extreme edges of the film frame. Compose your picture with a margin of safety at the edges.

Precautions for storage

- Avoid leaving the camera for extended periods in places where temperature and humidity are high such as in a car.
- Do not store the camera in a closet with mothballs or in a case where chemicals are handled. Store it in a place with good air circulation to prevent fungus growth.

Precautions for proper care

- Use a blower and lens brush to remove dust accumulated on the lens or the viewfinder window.
- Never use solvents such as paint thinner, alcohol or benzene to clean the camera. To clean the external camera surfaces, - but not glass surfaces; using a dry or silicone-treated cloth is recommended.

PRECAUTIONS FOR BATTERY

Other precautions

- The temperature range at which this camera functions properly is 50°C to -10 °C (122°F to 14°F).
- To maintain optimum performance, it is recommended that the camera be inspected every one or two years. If the camera has not been used for an extended period, or is being prepared for an important photographic session, it is recommended that you have the camera inspected or test shoot with it.
- The PENTAX warranty is provided only for the repair of defects in materials or workmanship. Damage of any kind cannot be repaired at no charge under the term of the warranty. If the difficulty is caused as a direct result of the product being used in conditions as outlined in the other operation contrary to the instructions outlined in this manual, charges will be assessed or a repair quotation will be provided.

LCD (Liquid-crystal display)

- When the LCD is exposed to high temperatures over about 60 °C, it may blacken, but when the temperature normalizes, it will return to normal.
- The LCD may also slow down in response to lower temperatures, but this is a normal characteristic of an LCD.

- Use one 3V lithium battery, type CR-2 or the equivalent.
- Misuse of a battery can cause hazards such as leakage, overheating, explosions, etc. The battery should be inserted with the “+” and “-” sides facing correctly.
- Never try to disassemble, short or recharge the battery. Also do not dispose of the battery in a fire, as it may explode.
- Battery performance may be temporarily hindered in low temperatures, but will recover in normal temperatures.
- Keep a spare battery on hand for replacement convenience when shooting outdoors or while traveling.
- When the camera is in a bag, make sure the main switch is OFF. Otherwise, battery power may be wasted if the shutter release button is accidentally pushed.

PRACTICAL SHOOTING GUIDE



Focusing

Taking a picture through a window.p.33



Flash photography

Taking a picture in low light situations.p.19

Minimizing the red-eye effect.p.22,23

Taking a portrait when the subject is in the shade.p.24

Taking a picture of people with sunset scenery in the background.p.25

Taking a picture of people with night scenery in the background.p.26



Zooming

Making a subject larger or smaller.p.10



Taking pictures of people in various situations

- Taking a portrait when the subject is in the shade.p.24
- Taking a picture of people with sunset scenery in the background.p.25
- Taking a picture of people with night scenery in the background.p.26
- Putting yourself into a picture.p.27



Landscape photography

- Taking a picture of people with sunset scenery in the background.p.25
- Taking a picture of night scenery.p.26
- Taking a picture of people with night scenery in the background.p.26
- Taking a picture of landscape scenery through a window.p.33



Others

- Taking a picture with the (Optional) Wireless Remote Control.p.29
- Imprinting date on a picture.p.39

TABLE OF CONTENTS

• Names of working parts	Flaps
• Introduction	Front fold out
• Outline of basic operations	Inside cover
• For safe use of your camera	1
• Precautions for your camera	2
• Precautions for battery	3
• Practical shooting guide	4
• Table of contents	6

PREPARATIONS BEFORE TAKING PHOTOGRAPHS

1. Strap attachment	7
2. Main switch	8
3. How to hold the camera	9
4. Operating the 38-115mm zoom lens	10

TAKING PHOTOGRAPHS

1. Film loading	11
2. Diopter adjustment	14
3. Viewfinder displays	15
4. Lamp indications	16
5. Taking pictures	17
6. Unloading film	20

TAKING BETTER PHOTOGRAPHS

How to select modes	
/ Red-eye reduction lamp mode	22
Daylight-sync shooting	24
Taking a picture at a slow shutter speed	25
Slow Shutter Speed (Flash-OFF)	25
Slow-Speed-Sync Shooting (Flash-ON)	25
Bulb shooting	26
Bulb-sync shooting	26
Self-timer photography	27
Using wireless remote control (option)	29
Infinity-landscape shooting	33
Focus lock shooting	34
Hard-to-autofocus subjects	35
Taking Panorama format picture	36
DATE MODEL	39

MAINTENANCE CONSIDERATIONS

Battery exhaustion warning	42
Installing / Replacing battery	43
Troubleshooting	44
Flash effective range with films other than ISO 100,200, or 400	45
Specifications	46
Warranty policy	48
LCD panel	51



STRAP ATTACHMENT

PREPARATIONS BEFORE TAKING PHOTOGRAPHS

For optimum performance you should familiarize yourself with certain fundamentals before taking any photographs.

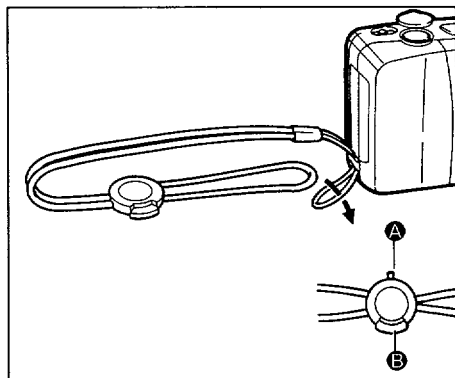

Fit the strap on the camera as illustrated.

- Use the illustrated part **A** for pushing the mid-roll rewind button to rewind a film before exposing all the frames. Use the illustrated part **B** for opening the battery chamber cover.



MAIN SWITCH

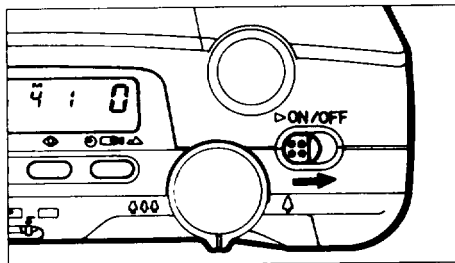

Main switch

To switch ON, slide the main switch to the direction of the arrow as illustrated. When the power turns ON, the lens slightly extends and the lens cover opens. The camera is now ready to shoot. To switch OFF, slide the main switch again.

- When not in use, ensure that the camera is switched OFF.
- If the camera is ON and left unused for over 3 minutes, the lens automatically retracts and the power is switched OFF to save the battery.

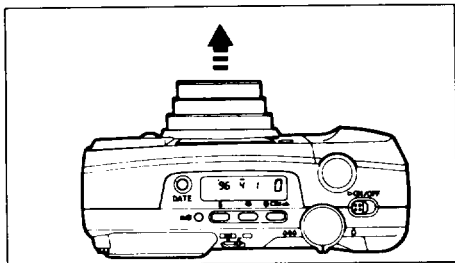

- See page 43 when the battery exhaustion symbol () appears on the LCD panel.
- Use one lithium battery (type CR-2 or the equivalent). The battery is used by both the camera and the data function on the DATE model to keep constant track of time. After the battery is replaced, correct the time. The date and the no. of frames are memorized and unchanged even if the battery is replaced.



HOW TO HOLD THE CAMERA

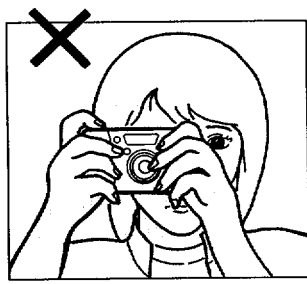
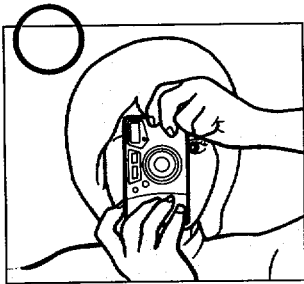
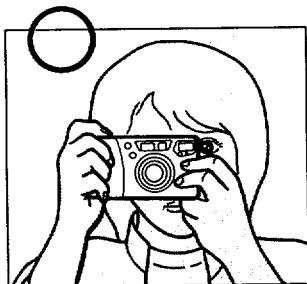

Keep the camera as still as possible, and gently depress the shutter release button. (If too much force is applied, the camera is likely to shake, and the picture will be blurred.) Try to brace your elbows against a stable, stationary object such as a wall. When using the flash with the camera positioned vertically, hold the camera so that the flash is above the lens.

Notes:

- Do not hold the zoom lens because it moves back and forth while in operation.
- Make sure not to obstruct the autofocus window, lens, light sensor window or the built-in flash with your fingers, hair or other object.



OPERATING 38-115mm ZOOM LENS

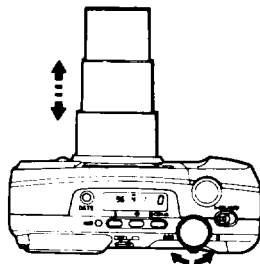
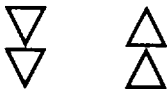

When you move the zoom lever to the right (↗), the lens moves towards the 115mm telephoto setting and frames the subject more closely. When you move the zoom lever to the left (↖), the lens moves towards the wide-angle 38mm setting. When the lens zooms to the desired setting, release the zoom lever and depress the shutter release button fully to take pictures.

- Do not apply force to the zoom lens as doing so causes damage to the camera.
- The shutter cannot be released while the lens is zooming.



FILM LOADING (Ensure the power is off before inserting the film.)

TAKING PHOTOGRAPHS

After reading this instruction manual you should be familiar with the functions available on the camera, and you're ready to insert the film.

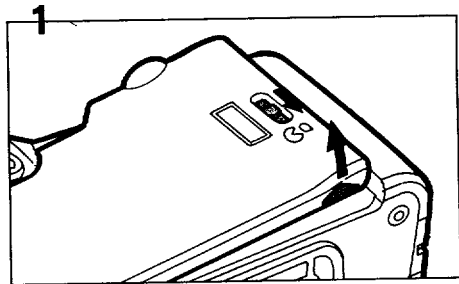

1 Slide the back cover release lever down and pull the back to open the back cover as illustrated.

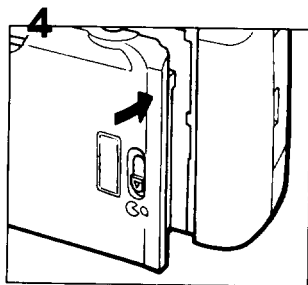
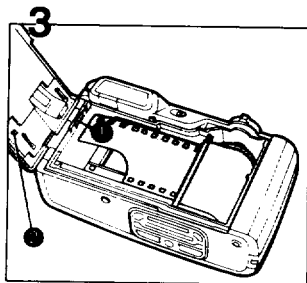
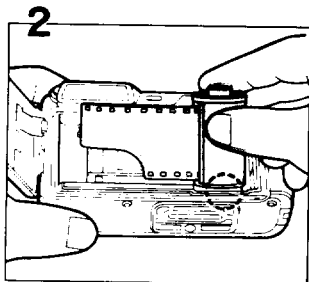

- 2 Place the film cartridge in the film chamber by fitting its flat side on the top of the rewind shaft first and then slide the top end of the film cartridge into the camera.
- 3 Pull the film leader out far enough from the cartridge to reach the take-up spool. Align the tip of the film with the film leader end mark ●
- 4 After the back cover is closed, the film automatically advances to the first frame.

Notes:

- Ensure the film is placed properly between the film guides.
- If there is dirt on the film detector ●, film cannot be wound properly.
- Ensure the film is taut as illustrated on the illustration. Take up any slack in the film by pushing it back into the cartridge.
- If the end of the film leader is extremely bent, straighten it or cut off the bent portion.

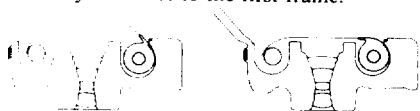

12 × Slack No!

○ Flat Yes!

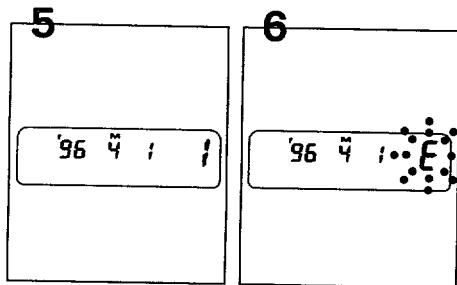

- 5 When “/” appears in the exposure counter on the LCD panel, the film automatically stops winding. The indication appears as shown above.
 - 6 If (E) blinks on the LCD panel, it means the film is not properly loaded. Reload the film.
- The exposure counter indication will remain on even if the main switch is turned OFF.

Automatic film speed setting

This camera is designed to use DX-coded films with ISO rating from 25 to 3200. When any of these films are loaded, the proper film speed is automatically set for the camera.

Notes:

- Non-DX coded films cannot be used. If Non-DX coded film is used, the film speed is automatically set to ISO 25.
- A film with ISO 400 film speed is recommended to get less image blur and to cover more of the photographic situations.
- Use high-speed films with ISO 800 or higher mainly for shooting indoors or in dimly-lit conditions.

2

DIOPTER ADJUSTMENT

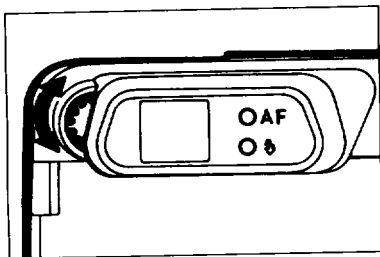

Aim the camera toward a bright subject. While looking through the viewfinder, rotate the diopter adjustment dial to the right or left until the AF frame appears in the sharpest focus.

- Be sure to adjust the diopter before use.



VIEWFINDER DISPLAYS

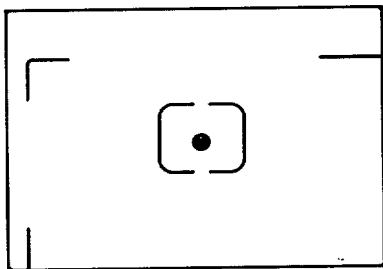

When the autofocus frame in the viewfinder is not clearly seen, adjust the diopter by moving the diopter adjustment dial.

- Autofocus frame
Focus on the subject with this frame.

Closer than 1.2m

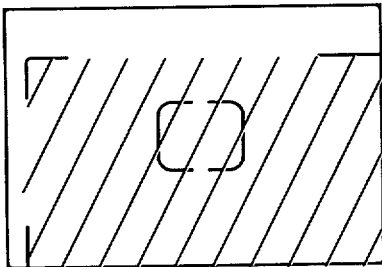

Close distance compensation frame

- When the camera-to-subject-distance is closer than 1.2m, compose the scene within this frame.
- Regular size color prints may cut off what appear on the extreme edge of the film frame. Compose your picture with a margin of safety at the edge.



LAMP INDICATIONS | Shooting distance: 0.65 (2.1ft) - ∞ (infinity)

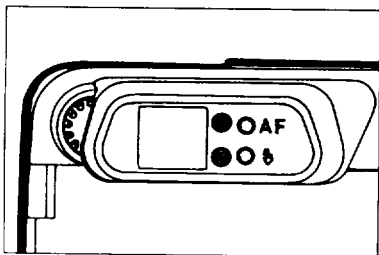

When you depress the shutter release button halfway down, the lamp ● and / or ● lights up or blinks as shown above.

① Green lamp (Focus status) :

When the subject is in focus, it will light up to indicate that you can take the picture; when the subject is not in focus, it will blink, indicating that you cannot take the picture because the camera-to-subject distance is too close or is a hard-to-autofocus subject.

② Red lamp (Flash status) :

When the flash is ready to discharge, it will light up. When the flash is being charged, it will blink.

Shooting ranges (effective camera-to-subject distance)

- The standard format and panorama format allow a shooting range from ∞ (infinity) to 0.65m (2.1 ft).

Focus aid illuminator

In low light situations and/or hard-to-autofocus subjects, the focus aid illuminator automatically emits a striped pattern to assist the autofocus system when the shutter release button is depressed halfway down.

5

TAKING PICTURES



This camera uses the five-point AF system to focus the subject. Even if the subject is slightly off the center of the AF frame, the subject will easily be brought into focus.

1 Composing the scene

After zooming the lens and composing your scene, focus on the subject with the autofocus frame

2 Checking the lamp indication

Depress the shutter release button halfway down. When the subject is in focus, the green lamp will light up.

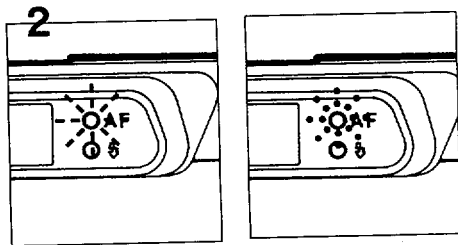

- The green lamp blinks when the camera is not able to obtain proper focus for one of the following reasons.
 - ① The subject is too close.
 - ② The subject is difficult to autofocus. See page 35.
- If the autofocus window is dirty, the autofocus may not function properly.

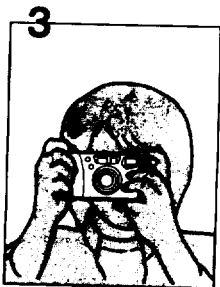

3 Shooting

Depress the shutter release button fully, and the shutter will be released. Then, the film automatically advances to the next frame.

Notes:

- If you wish to focus on another subject, lift your finger from the shutter release button and depress the shutter button halfway down again.
- The shutter cannot be released while the lens is zooming.

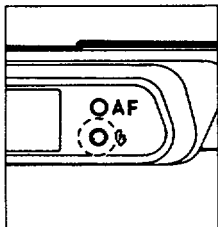

Automatic Flash Emission

When taking pictures in low light, the flash will automatically discharge. When the shutter release button is depressed halfway down in low light, the red lamp will light up, indicating the flash is ready to discharge. If the red lamp blinks, this indicates that the built-in flash is being charged and the shutter cannot be released. Therefore, make sure that the red lamp is lit continuously before taking pictures.

Flash effective ranges (Nega-color film used)

Lens \ ISO	100	200	400
38 mm (◆◆◆)	0.65~4.7m (2.1-15.4ft)	0.65~6.7m (2.1-22.0ft)	0.65~9.4m (2.1-30.8ft)
115 mm (◆)	0.65~2.0m (2.1-6.6ft)	0.65~2.9m (2.1-9.5)	0.65~4.0m (2.1-13.1ft)

See page 45 when any other ISO films are loaded.

Red-eye

Shooting portraits with the flash may result in "red-eye", the red dot in your subject's eye. This camera incorporates a red-eye reduction flash function which lights up the self-timer lamp for approx. 1 second before the flash is discharged. For setting the red-eye reduction flash function, see page 22.

6

UNLOADING FILM (Remove the film from the camera in the shade or by using your body to shade the camera)

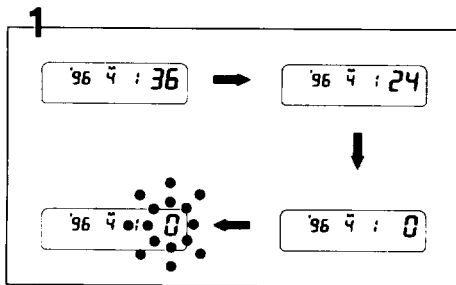

1 Rewinding the film

After you have exposed the last frame of the roll, the lens retracts and the film rewinds automatically. Then, the motor stops, and (0) blinks as shown to indicate that the film has been rewound.

- A 24-exposure roll of film takes about 20 seconds to be rewound.
- During rewinding, the exposure counter counts frame numbers in reverse.
- The entire roll of film including the film leader is always rewound into the cartridge to prevent any part of the film being exposed to light.

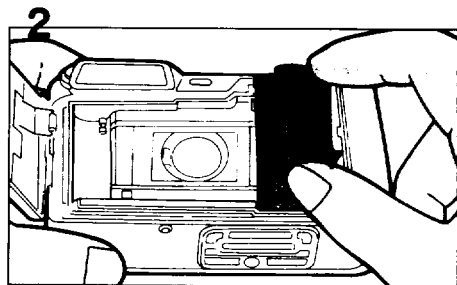

2 Unloading film

To unload the film, open the back cover, and remove the cartridge from the chamber.

Notes:

- The shutter may be released a frame or two even after the specified number of frames have been used up. If this occurs, these extra frames may be lost in the processing.
- Never open the back cover until the whole film roll is rewound.

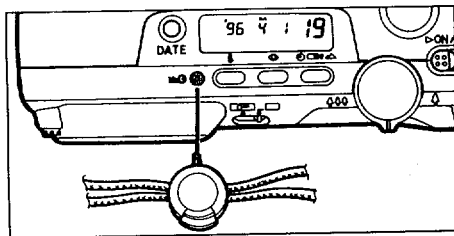

Rewinding a film in mid-roll

If you wish to unload a film before exposing all the frames, push the mid-roll rewind button with the protrusion part of the strap; the lens retracts and then film rewinding starts. When rewind is completed, the motor stops, and () blinks, indicating that the back cover may be opened safely.

HOW TO SELECT MODES / RED-EYE REDUCTION LAMP MODE

TAKING BETTER PHOTOGRAPHS

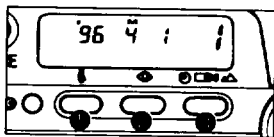

To set various exposure modes, depress the mode button ●.

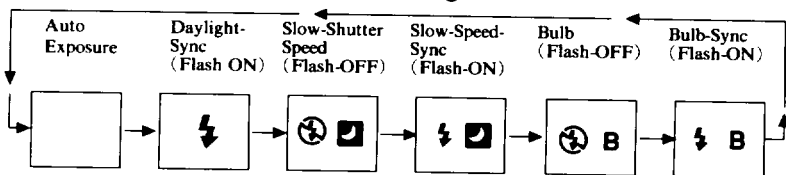



- For normal use, set the Auto Exposure Mode.
- In any exposure mode, if the button ● is depressed after the shutter is released, the Auto Exposure Mode is returned.

Red-Eye Reduction Lamp

To reduce the red-eye phenomenon in the picture, depress the red-eye reduction flash button (👁️) ●. With this mode, the self-timer lamp lights up for approx. 1 second just before the main flash is discharged to reduce the appearance of the red-eye effect. To cancel this mode, depress the red-eye reduction button again.

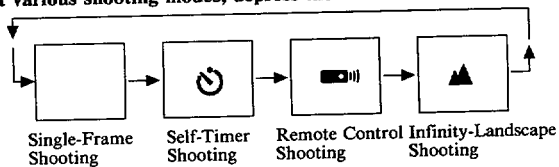
To set various shooting modes, depress the drive button .





- For normal use, set the Single-Frame Shooting Mode.
- In the Self-Timer Shooting and/or the Remote Control Shooting Mode, if the button  is depressed after the shutter is released, the Single-Frame Shooting Mode is returned automatically.

What is the red-eye phenomenon in flash photography

When a picture is taken using a flash, a subject's eyes may appear red in the print. This phenomenon is caused by the reflection of the electronic flash in the retina. It can be reduced when the surrounding of the subjects are brightened, or shooting distance is shortened or by employing the red-eye reduction flash feature.

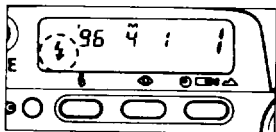
DAYLIGHT-SYNC SHOOTING



Depress the mode button until () appears on the LCD panel. In this mode, the flash will discharge in both dark and

bright conditions. When a portrait is taken with the subject in a backlight situation, the front of the subject may be cast in shadow. In such a case, use the Daylight-Sync Shooting Mode (Flash-ON mode) within the flash-effective range to take pictures. This will ensure that a picture is well exposed without any shadow. When you wish to discharge the flash, use this mode. In this mode, the flash will always discharge.

Note:

- Make sure you're within the flash-effective range even when you use the built-in flash as a fill-in flash in daylight. See page 19.



Without Daylight-Sync



With Daylight-Sync

TAKING PICTURES AT A SLOW SHUTTER SPEED

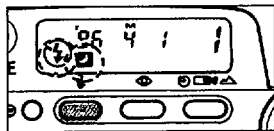

Slow Shutter Speed (Flash-Off)

Depress the mode button until (⚡) appears on the LCD panel. In this

mode, the flash does not discharge, and a picture is taken at a slow shutter speed up to approx. 2 seconds. Use it in places where the flash photography is prohibited, such as in theaters and museums. Furthermore, this mode is also useful for a natural existing light effect in low ambient photography.



With Slow-Speed-Sync

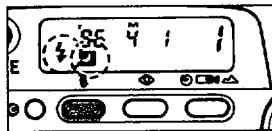

Slow-Speed-Sync Shooting (Flash-On)

Depress the mode button until (⚡) appears on the LCD panel. It is

possible to photograph subjects and background in a balanced way (as shown in the photo) by using the built-in flash to properly expose the foreground subject and a slow-speed to expose the low light background.

Notes:

- When shooting in low light, the shutter speed gets slower, and camera shake is likely to blur your picture. Use of a tripod is recommended.
- Make sure you are within the flash-effective range even when you use the built-in flash as a fill-in flash in daylight. See page 19.

BULB, BULB-SYNC SHOOTING

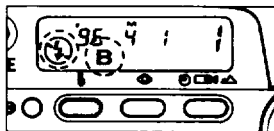

Bulb Mode (Ⓡ B)
Depress the mode button until (Ⓡ B) appears on the LCD panel.

This mode is useful for long exposures

required for shooting fireworks and night scenes, for example. When using this mode, the camera should be mounted on a tripod so that the camera will be steady.

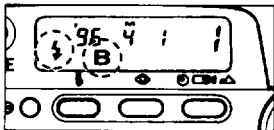

Bulb-Sync Mode (Ⓡ B)

Depress the mode button until (Ⓡ B) appears on the LCD panel.

This lets you use the flash in addition to the Bulb Mode, so you can take a portrait photograph with a night scene in the background, for example.



Bulb Mode, approx. 3 sec. (ISO 400)

- Make sure you're within the flash effective range even when the Bulb-Sync Mode in use. See page 19.
- The shutter remains open as long as the shutter release button held down.
- Use of a tripod is recommended.

SELF-TIMER PHOTOGRAPHY

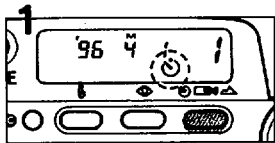

Self-Timer

Use the self-timer if you wish to get in the picture.
Use of a tripod is recommended.

- 1 Depress the drive button until (Ⓢ) appears on the LCD panel.

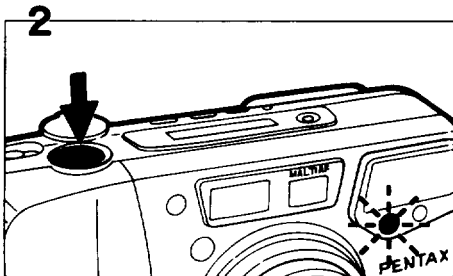

- 2 Focus on the subjects first by depressing the shutter release button fully. The shutter will be released in about 10 seconds. When the self-timer is working, the Self-Timer symbol (⊙) blinks on the LCD panel, and the Self-Timer lamp blinks 3 seconds before the shutter is released, letting you know when to smile.

How to cancel

To stop the self-timer operation at any time after its been activated, slide the main switch. In this instance, the power will not be turned OFF.

Notes on the self-timer shooting

- If you are standing directly in front of the camera when starting the Self-Timer, the camera will be focused on you, not the main subjects. Be sure that you are behind, or next to the camera when starting the Self-Timer.
- When you want to use the flash with the self-timer, ensure that the red lamp is lit indicating the flash has been charged before operating the self-timer.

USING WIRELESS REMOTE CONTROL (OPTION)

If you have purchased the optional wireless remote control, read this section. The wireless remote control allows you to trip the shutter at a distance. The shutter will be released in 3 seconds after the shutter release button on the remote control is depressed.

- Use a tripod when shooting with the wireless remote control.
- When the remote control is used to take pictures, the Self-Timer Shooting Mode and the Infinity-Landscape Mode cannot be used.
- Use the remote control to take pictures in the Bulb Mode to avoid camera shake. While the remote control's shutter release button is held down, the shutter remains open up to a max. of 5 minutes.

Name of parts

Shutter release button

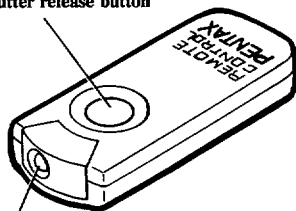

Remote control transmitter

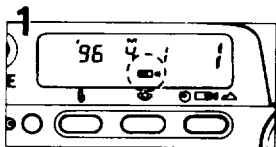

Remote Control Shooting Mode

- 1 Depress the camera's drive button each time until () symbol appears on the LCD panel.
 - If the shutter is released by the camera's release button, picture will be taken in the ordinary shooting mode.
 - When the camera is set in the Remote Control Shooting Mode and left unused for 10 minutes, the lens automatically retracts itself to save the battery and Single-frame will be set.

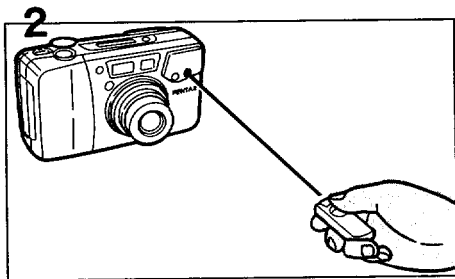

2 Compose the scene and frame the subject with the AF frame. Aim the remote control transmitter towards the remote control receiver on the camera, and then depress the shutter release button on the remote control fully to release the shutter.

- The self-timer lamp blinks rapidly for 3 seconds and then the shutter is released.
- If the shutter is released by the camera's release button, picture will be taken in the ordinary shooting mode.
- Focus cannot be locked when the remote control is in use. The subject framed in the AF frame will be in focus when the remote control's shutter release button is depressed.

Operating Distance of the Wireless Remote Control from the camera's front: within approx. 5m(16.5ft) straight in front of the camera

- The remote control may not work in a backlight situation. In this case, use the camera's shutter release button in the Self-Timer Mode to take pictures.
- The remote control does not work while the flash is being charged.

Battery life on the Remote Control

About 30,000 commands can be issued using the Remote Control with a battery installed. If the battery is exhausted, please have it replaced at your local Pentax Service center (there is a charge for this service).

INFINITY-LANDSCAPE SHOOTING

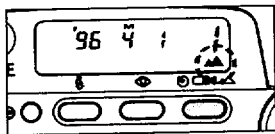

When you wish to take a sharp picture of a distant landscape or a distant subject through a window, the Infinity-Landscape Mode allows you to capture distant scenery with clarity.

Depress the drive button until (▲) appears on the LCD panel.

- After the picture is taken by fully depressing the shutter release button, this mode is canceled.
- The flash will not discharge in the auto exposure mode even in dark light situations.



FOCUS-LOCK SHOOTING

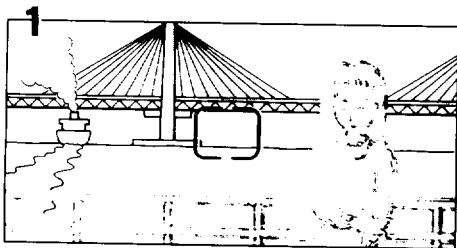

If you shoot without positioning the autofocus frame (□) on the main subject as shown above, only the background will be in focus. When the main subject is off the autofocus frame in the center of the viewfinder, use the focus-lock technique. (Focus lock is the function to lock focus.)

1 Focus on the subject with the autofocus frame (□).

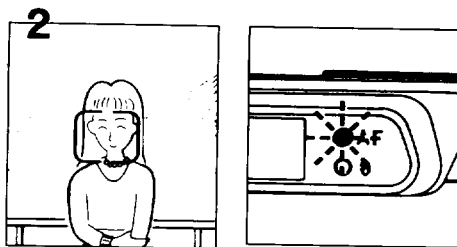

2 When the shutter release button is depressed halfway down, the green lamp lights up and the exposure and focus are temporarily locked.

HARD-TO-AUTOFOCUS-SUBJECTS

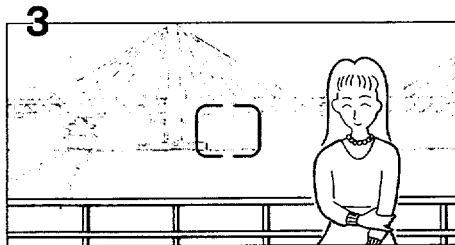

3 While depressing the shutter release button halfway, re-aim the camera or recompose the picture, then release the shutter.

Note:

- You can release focus lock simply by lifting your finger from the shutter release button.

The autofocus system is highly precise, but not perfect. Some subjects may not focus as you wish. In such a case, use the focus-lock technique on a subject near the actual one and equidistant from the lens. The subjects which may fool autofocus system include:

- a) Extremely low-contrast subjects such as a white wall or blue sky in the autofocus frame.
- b) Subjects which don't reflect much light in the autofocus frame.
- c) Subjects which moving too fast.
- d) Subjects with horizontal lines or with finely complex or detailed pattern in the autofocus frame.
- e) Multiple subjects in foreground of the autofocus frame.
- f) Subjects positioned against reflected light or strong backlight or with extremely bright background.

TAKING PANORAMA FORMAT PICTURE

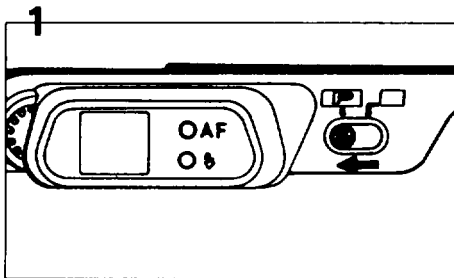

You can switch between the panorama format and standard format picture taking mode in the middle of the roll by moving the panorama switch. The panorama format picture allows horizontally positioned dynamic pictures to be taken (approx. 13x36mm on film).

1 Switching to the panorama format picture

Move the panorama switch to (P) to select the panorama format mode.

- When the picture frame is switched to panorama, the viewfinder switches to the horizontal panorama format frame.

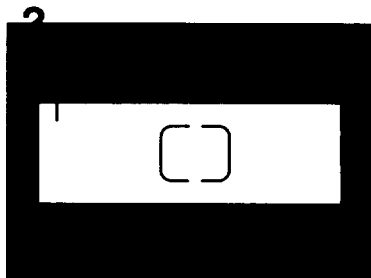

2 Taking a panorama format picture

Compose the scene within the panorama format frame, and then fully depress the shutter release button to take a panorama format picture.

- When the camera-to-subject distance is less than 1.2m, the panorama format photography is not recommended due to a substantial difference between what you see through the viewfinder versus the image you will obtain the actual picture taking area.



The mark “ — ” indicates the position where the data and time are imprinted.

The DATA MODEL allows you to record DATE information in the panorama mode in a similar manner to the standard picture taking mode. See “DATE MODEL” on page 39 for details. The dating unit automatically switches the DATE position between the standard and panorama according to the format mode selected.

NOTES ON THE DEVELOPMENT OF PANORAMA FORMAT PICTURES

- With panorama format pictures, only the middle area of the frame is exposed. The number of exposures available in the panorama format is equivalent to that of the standard photo size.



- When developing the film, if you have taken only panorama format pictures on the entire roll of film, tell the clerk at the processing lab to develop the film with only the panoramic format. If there are both panorama and standard format photographs on the film, ask the clerk to develop the film with both standard and panorama format.
- The development of panorama format pictures is a more time-consuming and expensive process than that of standard pictures. Please consult the processing lab for more details.
- Panorama format processing facilities differ depending on the area and requirements. Your local film processor or camera dealers will advise you on all the options to you.
- When the panorama format picture is printed with a standard size format, the black cropped areas will appear on the top and bottom of the picture.

DATE MODEL

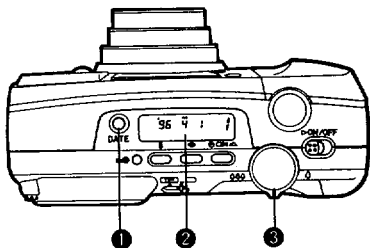

If you purchased the DATE model, read this section. The DATE model records dates up to the year 2030 on pictures.

Switching the Mode

Press the DATE button ❶ with your finger, the mode on the LCD panel switches as shown in the chart.

Notes:

- The data on the LCD panel will be imprinted on the film.
- "----" indicates no data will be imprinted.
- "M" on the LCD panel indicates "Month".

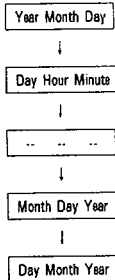

Correcting the date

Switch the power on.

1. Keep depressing the DATE button ● for 3 seconds, the "Year" digits and () will blink.
 2. Each time the DATE button ● is depressed, the blinking digits change in the following manner : Year - Month - Day - Hours - Minutes
Stop depressing the button when desired digits appear.
 3. Move the Zoom lever ● to the right or left, when you wish to change the blinking digits. The digits increase by one each time the lever moves to the right and the digits decrease by one each time the lever moves to the left. Holding the zoom lever for about one second will change the digits continuously.
 4. After the data has been adjusted, depress the DATE button ● each time until blinking stops.
- The blinking "minutes" allows precise fine-tuning of the internal clock to the beginning of a specified minute. To do so, depress the DATE button ● each time until the Minutes digits starts blinking, and then depress the DATE button in sync with a time signal.
 - If you release the shutter while the blinking data is being corrected, the data cannot be imprinted.

Operational precautions

The data on the LCD panel is imprinted on each frame you expose.



- “Year-Month-Day” and “Day - Hour - Minute” cannot be imprinted at the same time.
- As you release the shutter, the bar (—) mark on the display blinks for a few seconds, indicating the data has been imprinted.
- The dating unit automatically switches the imprint mode between the standard and panorama according to the format mode selected.
- If there is a white or yellow object in the corner of the picture where the data is imprinted, the data may be difficult to read. When composing your photographs, try to avoid brightly-colored subjects in that corner.

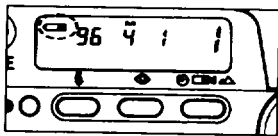

* The date in the picture above is simulated.

BATTERY EXHAUSTION WARNING



When the battery is nearly exhausted, the battery symbol () appears on the LCD panel to warn you. Replace the battery as soon as possible. When () starts blinking, no operations can be performed.

Battery life (using 24-exposure film rolls):

Approx. 8 rolls using flash 50% of the time (using the CR-2 battery and under Pentax testing conditions). Actual battery life/performance may vary drastically depending on usage of Power Zoom, Flash and external conditions such as temperature and freshness of the battery.

INSTALLING/REPLACING BATTERY Use one 3V lithium battery (CR-2 or equivalent)

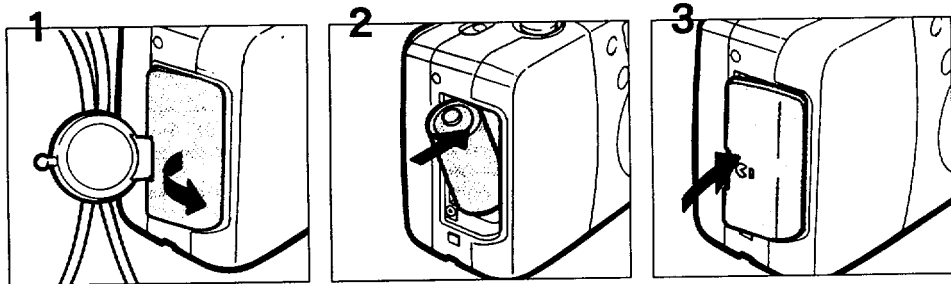

Ensure that the power is OFF before replacing the battery.

- 1 Open the battery chamber cover by using the strap as shown in the illustration.
- 2 Insert one lithium battery with the plus/minus (+/-) sides matching the indications in the battery compartment.
- 3 Close the battery chamber cover. Ensure that the cover is locked with a click.

Notes on replacing the battery:

- Ensure that the power is OFF before replacing the battery.
- The battery is used by both the camera body and the data function on the DATE model. After the battery is replaced or removed, the time is initialized to 0 00 and (----) bar marks appear on the LCD panel. See page 40 for correcting the time.
- The date and no. of exposed frames are memorized and unchanged even if the battery is replaced.

TROUBLESHOOTING

What appears troublesome may be easily remedied. Here are some problems that may occur and their remedies.

Symptoms	Causes and Remedies
1. The shutter cannot be released.	<ul style="list-style-type: none">• Is the main switch turned off? If so, turn it ON. See page 8.• Is the battery exhausted? Replace it or insert new battery if it is exhausted. See page 43.• Is (D) blinking on the LCD panel? If so, the film has been used up. Insert a new roll. See page 20.
2. My printed pictures don't look very clear.	<ul style="list-style-type: none">• Did you position the autofocus frame on your subject? See page 17.• Did you obstruct the autofocus window with your fingers, hair or other object when you depress the shutter release button? See page 9.• Is the autofocus window dirty? Wipe it off. See page 17.
3. Zoom lens retracted automatically. (the power is turned off automatically)	<ul style="list-style-type: none">• The power is automatically switched OFF if the camera is left unused for over 3 minutes. See page 8.• When the camera is ON and left unused for more than 10 minutes in the Remote Control shooting mode, the camera automatically switches itself OFF to save battery power. Turn the power ON again. See page 30.

Symptoms	Causes and Remedies
4. The Remote Control does not operate.	<ul style="list-style-type: none"> • The operable distance of the Remote Control is approx. 5m from the front. See page 32. • The Remote Control may not operate in a backlit situation. See page 32. • The flash is being charged. Wait until it fully charges. See page 32. • Is the battery for the remote control exhausted? See page 32.
5. The flash discharges, though it is not dark.	<ul style="list-style-type: none"> • The flash discharges automatically in a backlit situation. See page 19. • Daylight sync mode has been set. See page 24.
6. The (H) or (U) mark is displayed on the LCD panel.	<ul style="list-style-type: none"> • If either mark disappears when the zoom lever is moved, the camera is ready for use. The camera may be defective if either mark appears often.



Flash effective ranges other than ISO 100, 200 or 400 (Nega-color film used)

ISO \ Lens	25	50	800	1600	3200
38mm (◆◆◆)	0.65-2.4m (2.1-7.9ft)	0.65-3.3m (2.1-10.8ft)	0.80*-13.0m (2.6*-42.6ft)	1.2*-19.0m (3.9*-62.3ft)	1.7*-27.0m (5.6*-88.6ft)
115mm (◆)	0.65-1.0m (2.1-3.3ft)	0.65-1.4m (2.1-4.6ft)	0.65-5.7m (2.1-18.7ft)	0.65-8.0m (2.1-26.2ft)	0.7*-11.0m (2.3-36.1ft)

* With high speed film, overexposure may occur at close range due to the film's high sensitivity.

SPECIFICATIONS

Type:	35mm fully automatic lens-shutter with built-in zoom lens and auto flash
Film:	Auto film speed setting with 35mm perforated DX-coded film with ISO rating from 25-3200 (1EV step). Non-DX coded films are automatically set to ISO25
Format:	24x36mm (Approx. 13x36 in panoramac format)
Film loading:	Auto film loading. Closing the back cover will automatically wind the film to first exposure.
Film winding:	Auto film-winding (single-frame)
Film rewinding:	Auto film rewinding at the end of roll. Auto stop upon completion of rewinding. Rewinding time: approx. 20 sec. with 24-exposure film. Rewinding in mid-roll provided.
Frame number:	Automatic readout of successive frame numbers in ascending order when shooting, and descending order when rewinding.
Lens:	Pentax power zoom 38-115mm f/3.9 -10.5 7 elements in 6 groups. Angle of view: 59° - 21.5°
Focusing system:	Pentax phase-matching passive five-point autofocus system. Autofocusing range: 0.65m (2.1 ft) - infinity. Maximum magnification: approx. 1/4.9X. Focus lock is provided. Infinity-landscape mode (focus is fixed to infinity). Focus aid illuminator is automatically emitted in low light or hard-to-autofocus subject.
Zooming:	Electronic zoom
Shutter:	Programmed AE electronic shutter with speed approx. 1/300 - 2 sec. Bulb: 1/2 sec.-5 min. Electromagnetic release.
Self-timer:	Electronic lamp indication. Approx.10 sec. Cancellation after activation is possible.
Viewfinder:	Standard / panorama switchable. Actual image zoom viewfinder, Viewfinder area: 83%, Magnification: 0.43X (38mm WIDE) - 1.08X (115mm TELE). Diopter adjustment: -3 to +1D, AF frame, Picture frame, Close distance compensation frame, Panorama format picture area. Green lamp lighting: in-focus signal Green lamp blinking: When subject is too close and/or hard-to-autofocus subject. Red lamp lighting: Flash-ready status, Red lamp blinking: Flash being charged.

Exposure control:	Programmed auto-exposure control with multi metering system, Range: EV9 - EV17 at 38mm WIDE, EV13 - EV20 at 115mm TELE in Auto or Daylight-Sync mode (ISO 400), EV4 - EV17 at 38mm WIDE EV6 -EV20 at 115mm in Slow-Shutter-Speed mode (ISO 400), Automatic exposure compensation in a backlit situation.
Flash:	Built-in flash with red-eye reduction mode, Automatic discharge in low lighting and backlighting situations in auto mode, Flash ON = Day-light Sync / Slow-Shutter-Speed Sync (up to 2 sec.), Flash-OFF Mode, Bulb-Sync 1/2 sec. - 5min.
Flash effective range:	0.65 - 9.4m (38mm WIDE), 0.65 - 4.0m (115mm TELE) (ISO 400 film used).
Flash recycling time:	Approx. 5 sec. under Pentax testing conditions.
Power source:	One 3V lithium battery (CR-2 or the equivalent)
Battery life:	Approx. 8 rolls of 24 exposure film when 50% of shooting uses flash (under Pentax testing conditions)
Battery exhaustion warning:	() appears on the LCD panel, Shutter is locked when () is blinking.
Size & Weight:	111.0(W) x 61.0(H) x 40.5(D)mm (4.4"x 2.4"x 1.6") 215 g(7.6oz) without battery
DATE MODEL	
Date mechanism:	Crystal quartz controlled; LCD with digital clock, auto calendar up to 2030. Possible to imprint both standard and panoramic format frames. .
Imprinting mode:	"Year, Month and Day", "Day, Hour and Minutes", "---- blank", "Month, Day and Year" or "Day, Month and Year".
Size & Weight:	111.0 (W) x 61.0(H) x 40.5(D)mm (4.4"x 2.4"x 1.6") 215g(7.6oz) without battery
REMOTE CONTROL	
	Infrared wireless remote control, 3-seconds delay shutter release, Effective range: Closer than 5m when projected from the camera's front.
Power source for Remote Control:	One lithium battery CR1620 (replaced by Pentax Service facility)
Size & weight for Remote Control:	22.0(W) x50.0(L) x9.5(D)mm (0.9" x2.0" x0.4"), 9g(0.3oz) including battery

SPECIFICATIONS ARE SUBJECT TO CHANGE AT ANY TIME WITHOUT NOTIFICATION OR ANY OBLIGATION ON THE PART OF THE MANUFACTURER.

WARRANTY POLICY

All Pentax cameras purchased through authorized bona fide photographic distribution channels are guaranteed against defects of material or workmanship for a period of twelve months from date of purchase. Service will be rendered, and defective parts will be replaced without cost to you within that period, provided the equipment does not show evidence of impact, sand or liquid damage, mishandling, tampering, battery or chemical corrosion, operation contrary to operating instructions, or modification by an unauthorized repair shop. The manufacturer or its authorized representatives shall not be liable for any repair or alterations except those made with its written consent and shall not be liable for damages from delay or loss of use or from other indirect or consequential damages of any kind, whether caused by defective material or workmanship or otherwise; and it is expressly agreed that the liability of the manufacturer or its representatives under all guarantees or warranties, whether expressed or implied, is strictly limited to the replacement of parts as herein before provided. No refunds will be made on repairs performed by non-authorized Pentax service facilities.

Procedure During 12-month Warranty Period

Any Pentax which proves defective during the 12 month warranty period should be returned to the dealer from whom you purchased the equipment or to the manufacturer. If there is no representative of the manufacturer in your country, send the equipment to the manufacturer with postage prepaid. In this case, it will take a considerable length of time before the equipment can be returned to you owing to the complicated customs procedures required. If the equipment is covered by warranty, repairs will be made and parts replaced free of charge, and the equipment will be returned to you upon completion of servicing. If the equipment is not covered by warranty, regular charges of the manufacturer or of its representatives will apply. Shipping charges are to be borne by the owner. If your Pentax was purchased outside of the country where you wish to have it serviced during the warranty period, regular handling and servicing fees may be charged by the manufacturer's representatives in that country. Notwithstanding this, your Pentax returned to the manufacturer will be serviced free of charge according to this procedure and warranty policy.

In any case, however, shipping charges and customs clearance fees are to be borne by the sender. To prove the date of your purchase when required, please keep the receipts or bills covering the purchase of your equipment for at least a year. Before sending your equipment for servicing, please make sure that you are sending it to the manufacturer's authorized representatives or their approved repair shops, unless you are sending it directly to the manufacturer. Always obtain a quotation for the service charge, and only after you accept the quoted service charge, instruct the service station to proceed with the servicing.

The local warranty policies available from Pentax distributors in some countries can supersede this warranty policy. Therefore, we recommend that you review the warranty card supplied with your product at the time of purchase, or contact the PENTAX distributor in your country for more information and to receive a copy of the warranty policy.

STATEMENT OF FCC COMPLIANCE

This device complies with Part 15 of the FCC Rules. Operation is subject to the following two conditions : (1) This device may not cause harmful interference, and (2) this device must accept any interference received, including interference that may cause undesired operation.

Changes or modifications not approved by the party responsible for compliance could void the user's authority to operate the equipment. This equipment has been tested and found to comply with the limits for a Class B digital device, pursuant to part 15 of the FCC Rules. These limits are designed to provide reasonable protection against harmful interference in a residential installation. This equipment generates, uses and can radiate radio frequency energy and, if not installed and used in accordance with the instructions, may cause harmful interference to radio communications. However, there is no guarantee that interference will not occur in a particular installation. If this equipment does cause harmful interference to radio or television reception, which can be determined by turning the equipment off and on, the user is encouraged to try to correct the interference by one or more of the following measures :

- Reorient or relocate the receiving antenna.
- Increase the separation between the equipment and receiver.
- Consult the dealer or an experienced radio/TV technician for help.

This Class B digital apparatus meets all requirements of the Canadian Interference-Causing Equipment Regulations.

NAMES OF WORKING PARTS II

FOR YOUR REFERENCE, KEEP THIS CARD WITH THE CAMERA.

PENTAX IQZ^{zoom}115M

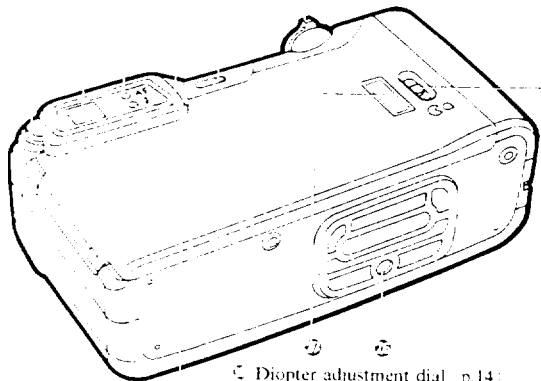

- ① Diopter adjustment dial p.14
- ② Viewfinder eyepiece
- ③ Green lamp p.16
- ④ Red lamp p.16
- ⑤ Panorama switch p.36
- ⑥ Zoom lever p.10
- ⑦ Back cover release lever p.11
- ⑧ Tripod socket
- ⑨ Film information window
- ⑩ Back cover p.11

BEHIND THE LENS STAYS OPEN FOR AS LONG AS YOU PRESS THE SHUTTER RELEASE BUTTON

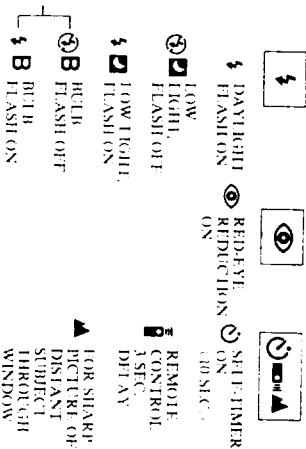

**FOR YOUR REFERENCE, KEEP
THIS CARD WITH THE CAMERA.**

LCD PANEL

PENTAX® IQZ_{OOM} 115M

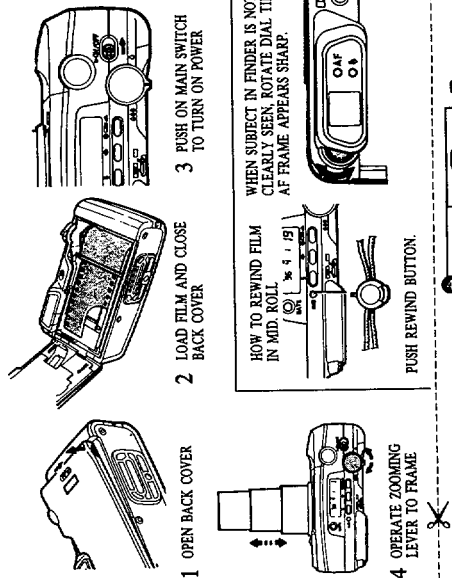

All indications will not actually appear simultaneously as shown.

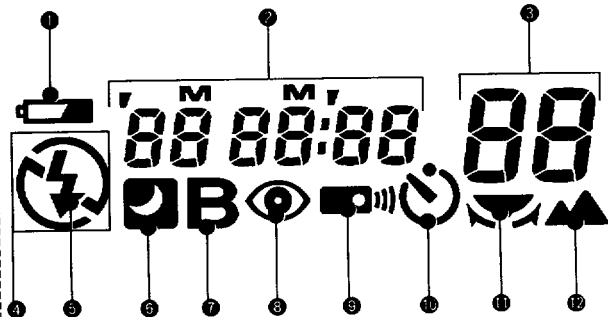

- 1** Battery Exhaustion Warning (p.42)
- 2** Data information (p.39)
- 3** Exposure counter (p.13)
- 4** Flash OFF (p.25, p.26)
- 5** Flash ON (p.24, p.25, p.26)
- 6** Slow-Speed-Shutter (p.25)
- 7** Bulb (p.26)
- 8** Red-eye Reduction feature (p.22)
- 9** Remote Control Shooting Mode (p.29)
- 10** Self-Timer (p.27)
- 11** Zoom lever (p.40)
- 12** Infinity-Landscape Mode (p.33)



Asahi Optical Co., Ltd. 11-1, Nagata-cho 1-chome, Chiyoda-ku, Tokyo 100, JAPAN

Pentax Europe n.v. Weveldlaan 3-5, 1930 Zaventem, BELGIUM

Pentax GmbH. Julius-Vosseler-Strasse, 104, D-22527 Hamburg, GERMANY

Pentax U.K. Limited. Pentax House, Heron Drive, Langley, Slough SL3 8PN, U.K.

Pentax France S.A. Z.I. Argenteuil, 12, rue Ambroise Croizat, 95100 Argenteuil, FRANCE

Pentax Benelux B.V. (for Netherlands) Spinveld 25, 4815 HR Breda, NETHERLANDS

(for Belgium & Luxemburg) Weveldlaan 3-5, 1930 Zaventem, BELGIUM

Pentax (Schweiz) AG Industriestrasse 2, 8305 Diethikon, SWITZERLAND

Pentax Scandinavia AB Falhagsleden 57, 75127 Uppsala, SWEDEN

Pentax Corporation 35 Inverness Drive East, Englewood, Colorado 80112, U.S.A.

Pentax Canada Inc. 3131 Universal Drive, Mississauga, Ontario L4X 2E5, CANADA