

PENTAX®

OPERATING MANUAL

IQZ_{oom}140







IQZ_{oom}140_{DATE}



Congratulations on your purchase of the PENTAX IQ Zoom 140 and welcome to the world of Pentax zoom compact photography! Your compact, light weight camera is a great companion to preserve your favorite memories. Its built-in 38-140mm lens gives you the freedom to frame everything from breathtaking landscapes to family portraits, even detailed close-ups. The built-in auto flash helps you capture subjects in dimly-lit palces or photograph indoor scenes with clarity and brilliance. Also included are panorama / standard format mid-roll switching capability and a wirelss remote control feature. Multi (6)-segment metering system ensures very precise metering for otimum exposure under any given lighting conditions. Since most of the operation - including film loading, film speed setting, winding / rewinding, focus and exposure control - are automatic, you can take great pictures effortlessly. The DATE model makes it easy to remember the dates when you took pictures.

- Please read this manual carefully before operating the camera to take consistently superior pictures.
- Pay special attention to the cautions and notes in this Operating Manual. Pictures and illustrations shown herein may differ from the camera's actual appearance.

Icon indications used in this manual

Operation direction	
Automatic operation	
Attention	
Lamp lighted	
Lamp blinking	
Correct	
Incorrect	

The name of the camera's working parts are listed on the front and back flaps of this manual. Keep the flaps unfolded for quick reference while reading the manual.

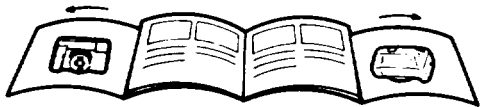

NAMES OF WORKING PARTS

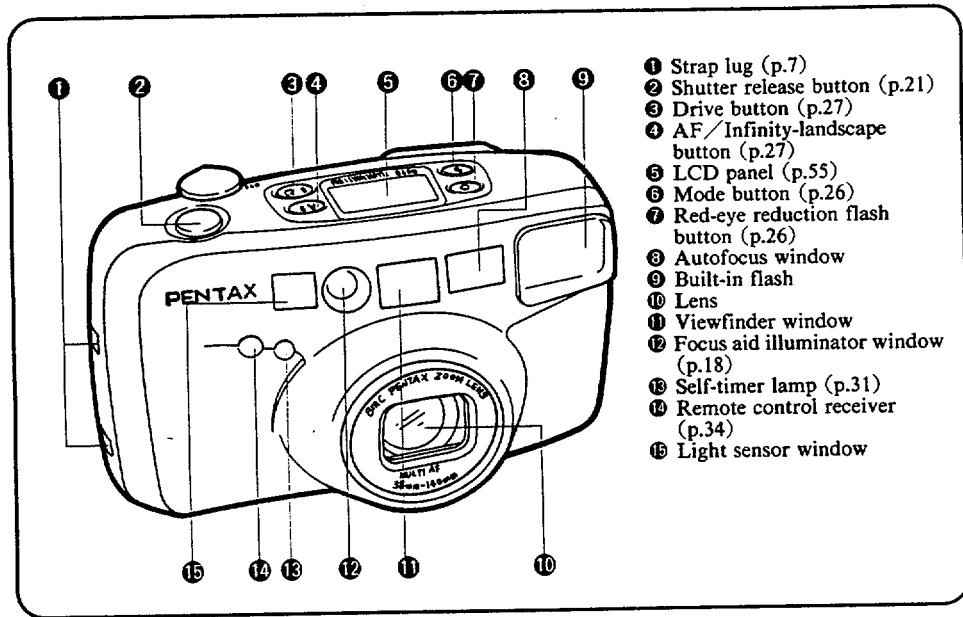

OUTLINE OF BASIC OPERATIONS

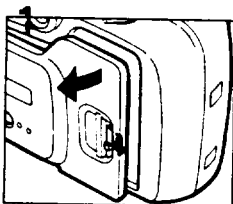

1 Open the back cover (see page 13).

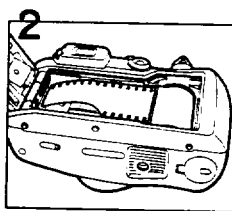

2 Load the film and close the back cover (see page 13).

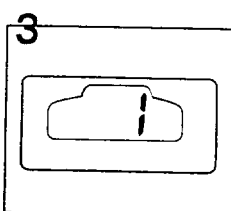

3 The film will automatically advance to the first frame (see page 14).

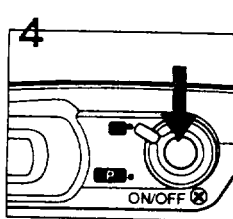

4 Push the main switch button to switch on power (see page 8).

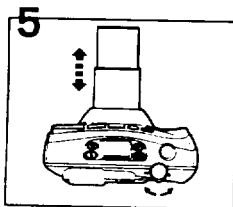

5 Frame your subject and operate the zooming lever to compose the shot (see page 11).



6 Focus on your subject (see page 21).

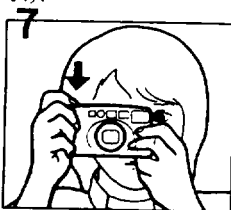

7 Depress the shutter release button. In dark conditions, the flash will discharge automatically (see page 22).

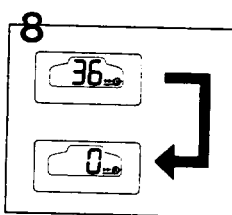

8 When the film is finished, the camera will automatically rewind it (see page 24).

PRECAUTIONS FOR YOUR CAMERA

Precaution when taking pictures

- Do not use the camera in a place where the camera may come in contact with rain or water because the camera is not weather-resistance. Should the camera get wet from rain or splashing water, wipe it off immediately with a dry soft cloth.
- Do not drop the camera or allow it to hit a solid object. If the camera suffers a severe shock or impact, take it to a Pentax service center for inspection.
- Be careful not to subject the camera to strong vibrations, shock or pressure. Use a cushion to protect the camera when carrying it in a motorcycle, car, boat, etc.
- Condensation on the interior or the exterior of the camera may be extremely harmful to the camera mechanism as it may cause rust and/or corrosion. Furthermore, if the camera is taken from warm temperature to a sub-freezing one or vice versa, the formation of icelets may cause the damage. In such a case, put the camera into a case or plastic bag so that any changes in temperature will be as gradual as possible. After temperature difference is minimized, take it out of the bag.

- Do not apply force to the zoom lens; do not place the camera with lens facing downward.
- Dirt, mud, sand, moisture, toxic gas, water, salt water, etc., penetrating the inside of the camera may cause damage or render it inoperable. Damage of any kind will not be prepared under the terms of the warranty and charges may be assessed. Therefore, handle the camera with great care.

Precaution for taking care

- Use a blower and lens brush to remove dust accumulated on the lens or the viewfinder window.
- Never use solvents such as paint thinner, alcohol or benzine to clean the camera. To clean the external camera surfaces, - but not glass surfaces; using a dry or silicone-treated cloth is recommended.
- The electric circuitry inside the camera contains high voltage working parts. Never attempt to disassemble the camera.

Precaution for storage

- Avoid leaving the camera for extended periods in places where temperature and humidity are high such as in a car.
- Do not store the camera in a closet with mothball or in a case where chemicals are handled. Store it in a place with good air circulation to prevent fungus growth.

Other precautions

- The temperature range at which this camera functions properly is 50°C to -10°C (122°F to 14°F).
- Regular size color prints may cut off what appears on the extreme edges of the film frame. Compose your picture with a margin of safety at the edge.
- To maintain optimum performance, it is recommended that the camera be inspected every one or two years. If the camera has not been used for an extended period, or is being prepared for an important photographic session, it is recommended that you have the camera inspected or test shoot with it.

- Repairs made necessary as a rebuilt of the camera being subjected to any of the conditions warned about in this precautions section, or any other precaution or warning throughout this operating manual, are not covered under the terms of the warranty and charges may be assessed.

PRECAUTIONS FOR BATTERY

Precaution for battery

- Misuse of a battery can cause hazards such as leakage, overheating, explosions, etc. The battery should be inserted with the “+” and “-” sides facing correctly.
 - Never try to disassemble, short or recharge the battery. Also do not dispose of the battery in a fire, as it may explode.
 - Battery performance may be temporarily hindered in low temperatures, but will recover in normal temperatures.
 - Keep a spare battery on hand for replacement convenience when shooting outdoors or while traveling.
- Keep the battery out of the reach of children.
 - When the camera is in a bag, make sure the main switch is off; otherwise, battery power may be wasted if the shutter release button is accidentally pushed.

PRACTICAL SHOOTING GUIDE



Focusing

Taking a picture through a window.	p.37
Taking a picture of distant landscape scenery.	p.37
Focusing on a particular spot.	p.38



Flash photography

Taking a picture in low light situations.	p.19
Minimizing the red-eye effect.	p.26
Taking a portrait picture whose face is cast in the shadow.	p.28
Taking a picture of people with sunset scenery in the background.	p.29
Taking a picture of people with night scenery in the background.	p.30



Zooming

Making a subject larger or smaller.	p.11
--	------



Taking pictures of people in various situations

Taking a portrait picture whose face is cast in shadow.	p.28
Taking a picture of people with sunset scenery in the background.	p.29
Taking a picture of people with night scenery in the background.	p.30
Putting yourself into a picture.	p.31



Landscape photography

Taking a picture of people with sunset scenery in the background.	p.29
Taking a picture of night scenery.	p.30
Taking a picture of people with night scenery in the background.	p.30



Others

Taking more than 2 pictures on the same frame.	p.36
Taking a picture at the distant place from the camera.	p.32
Imprinting date on a picture.	p.44

TABLE OF CONTENTS

• Names of working parts	Flaps
• Introduction	Front foldout
• Outline of basic operations	Inside cover
• Precautions for your camera	1
• Precautions for battery	3
• Practical shooting guide	4
• Table of contents	6

PREPARATIONS BEFORE TAKING PHOTOGRAPHS

1. Strap attachment	7
2. Main switch	8
3. Battery check	9
4. How to hold the camera	10
5. Operating the 38-140mm zoom lens	11

TAKING PHOTOGRAPHS

1. Usable film	12
2. Film loading	13
3. Viewfinder displays and shooting ranges	15
4. Lamp indications	18
5. Ordinary photography	19
6. Diopter adjustment	20
7. Automatic LCD illuminator	20
8. Taking pictures	21
9. Unloading film	24

TAKING BETTER PHOTOGRAPHS

How to select modes	
/ Red-eye reduction flash mode	26
Daylight-synchro shooting	28
Taking a picture at a slow shutter speed	29
Slow-speed synchro photography	29
Bulb shooting	30
Bulb-synchro shooting	30
Self-timer photography	31
Using wireless remote control (option)	32
Multi-exposure shooting	36
Infinity-landscape shooting	37
Spot AF shooting	38
Focus lock shooting	39
Taking Panoramic format picture	41
DATE MODEL	44

MAINTENANCE CONSIDERATIONS

Battery exhaustion warning	46
Installing/Replacing the battery	47
Troubleshooting	48
Flash effective range with films other than ISO 100,200, or 400	49
Specifications	50
Warranty policy	52
LCD panel	55



STRAP ATTACHMENT

PREPARATIONS BEFORE TAKING PHOTOGRAPHS

For optimum performance you should familiarize yourself with certain fundamentals before taking any photographs.

Fit the strap on the camera as illustrated. Use the illustrated part of the strap to open the battery chamber cover, adjust the data on the Date model, or push the auxiliary rewind button to rewind a film before exposing all the frames.

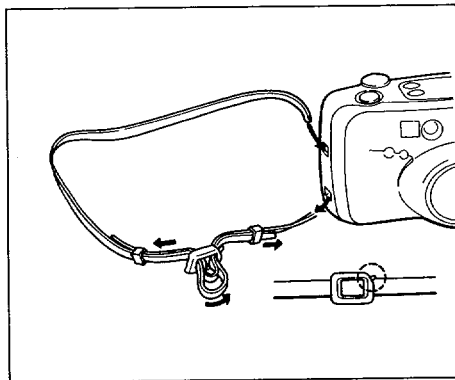

2

MAIN SWITCH

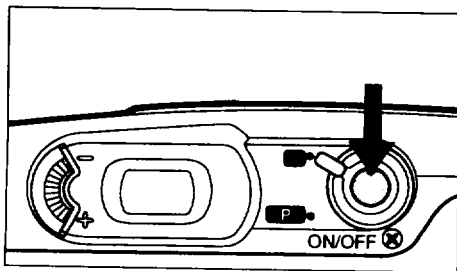

Main Switch

To switch on, push the main switch button. The lens extends slightly to the wide-angle 38mm and the LCD panel is on. To switch off, push the main switch button again. When not in use, ensure that the camera is switched off.

- Use one 3V lithium battery, type CR123A or the equivalent. Do not remove the battery before it is exhausted, since it is used by the date function on the DATE model to keep constant track of time.

- The lens cover automatically opens and closes when the main switch is turned on and off. Never attempt to open the lens cover manually.



BATTERY CHECK

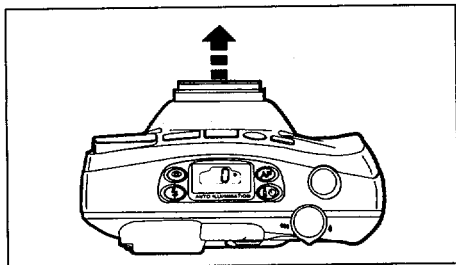

Battery check

After you turn the main switch ON, the lens slightly extends and the lens cover opens. You are now ready to shoot. See page 46 when the battery exhaustion symbol () appears on the LCD panel.

- If the camera is on and left unused for over 3 minutes, the lens automatically retracts and the power switches off to save the battery power.
- If the main switch is turned on within 60 minutes of auto-power off, the previous setting will automatically return.



HOW TO HOLD THE CAMERA

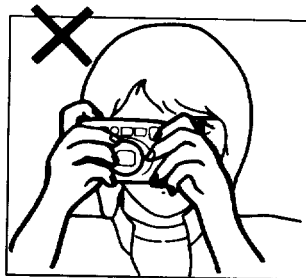
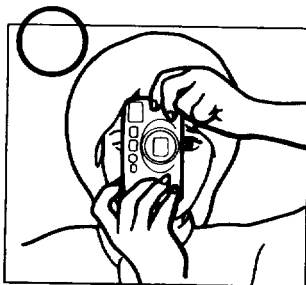
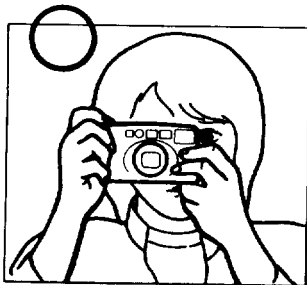

When shooting, hold the camera securely with both hands. Keep the camera as still as possible, and gently depress the shutter release button. (If too much force is applied, the camera is likely to shake, and the picture will be blurred.) Try to brace your elbows against a stable, stationary object such as a wall. When using the flash with the camera positioned vertically, hold the camera so that the flash is above the lens.

Notes:

- Do not hold the zoom lens because it moves back and forth while in operation.
- Make sure not to obstruct the autofocus window, lens, light sensor window or the built-in flash with your fingers, hair or other object.



OPERATING 38-140mm ZOOM LENS

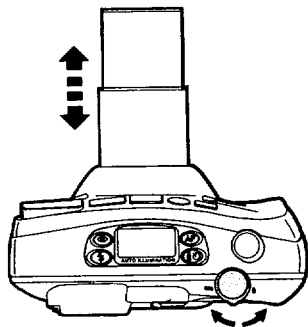

When you move the zooming lever to the right (◆), the lens moves towards the 140mm telephoto setting and frames the subject more closely. When you move the zooming lever to the left (◆◆◆), the lens moves towards the wide-angle 38mm setting. When the lens zooms to the desired setting, release the zooming lever and depress the shutter release button fully to take pictures.



USABLE FILM

TAKING PHOTOGRAPHS

After reading this instruction manual you should be familiar with the functions available on the camera, and you're ready to insert the film.

Notes:

- Use only DX-coded films.
- Non-DX coded film cannot be used. If non-DX coded film is used, the camera automatically sets the film speed to ISO 25.
- A film with ISO400 film speed is recommended to get less image blur and to cover more of the photographic situations.
- Use high-speed films with ISO 800 or higher mainly for shooting indoors or in dimly-lit conditions.

Automatic film speed setting

This camera is designed to use DX-coded films with ISO rating from 25 to 3200. When any of these films are loaded, the proper film speed is automatically set for the camera.

2

FILM LOADING (Ensure the power is off before inserting the film.)

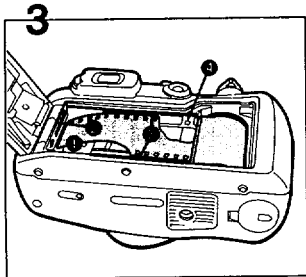
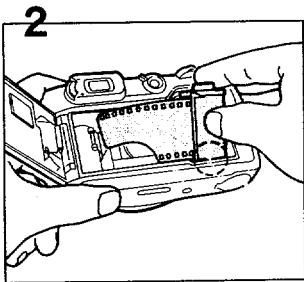
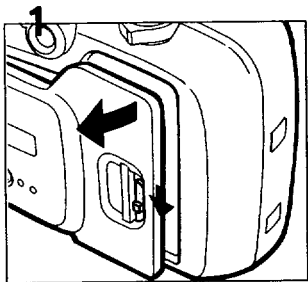

- 1 Slide the back cover release lever down in the direction of the arrow to open the back as illustrated.
- 2 Place the film cartridge in the film chamber by fitting its flat side on top of the rewind shaft first and then slide the top end into the camera.
- 3 Pull the film leader out far enough from the cartridge to reach the take-up spool ①. Align the tip of the film with the film leader end mark ②.

Notes:

- Ensure the film is placed properly between the film guides ③.
- If there is dirt on the film detector ④, film cannot be wound properly.

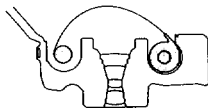

× Slack No!

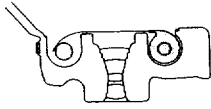

○ Flat Yes!

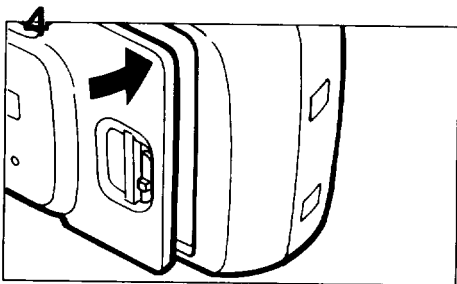

4 After the back cover is closed, the film automatically advances to the first frame.

- Even if no film is loaded, the motor operates for a second or two after the back cover is closed.
- Ensure the film is taut as illustrated on the previous page. Take up any slack in the film by pushing it back into the cartridge.
- If the end of the film leader is extremely bent, straighten it or cut off the bent portion.

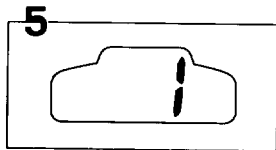

5 When “/” appears in the exposure counter on the LCD panel, the film automatically stops winding. The indication appears as shown above. If (/) does not appear on the LCD panel, it indicates that the film is not properly loaded. If (E) blinks on the LCD panel, it means the film is not properly loaded.

- The exposure counter indication will remain on even if the main switch is turned off.
- If the camera is placed in a condition where static electricity may be discharged on or near the camera, the LCD film counter may change to number one, but you can continue to use all other functions of the camera normally.



VIEWFINDER DISPLAYS (Switch on power by depressing the main switch button.)

Ordinary photography

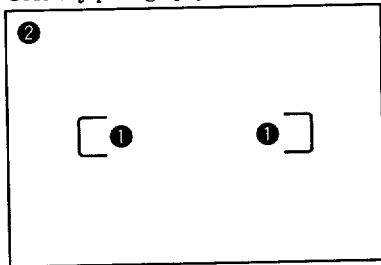

Panoramic format picture

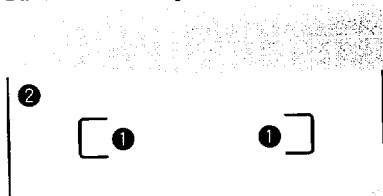

When the autofocus frame in the viewfinder is not clearly seen, rotate the diopter adjustment dial until the autofocus frame appears in the sharpest focus. See page 20. The autofocus frame and the picture area in the viewfinder automatically vary in accordance with the distance to the subject and focus length you have set. See page 16 and 17.

Ordinary photography (standard format)

- ① Autofocus frame. Autofocus is referred to as "AF". Focus on the subject with this frame.
- ② Picture area
When taking a normal picture, compose the scene within this frame.

Panoramic format picture

- ① Autofocus frame
- ② Picture area
When taking panoramic pictures, compose the scene within this frame.

Shooting ranges for standard and panoramic format pictures (effective camera-to subject distance)

- The ordinary photography and panoramic mode allow a shooting range from 1m (3.3 ft) to infinity (telephoto 140mm side) and 0.73m (2.4 ft) to infinity wide-angle 38mm side).
- Subjects closer than 1m at 140mm or 0.73m at 38mm cannot be focused properly.

Close distance compensation frame

When the distance to the subject becomes closer, the picture area of this camera is automatically changed and compensated. Compose the scene within this frame.

Standard format

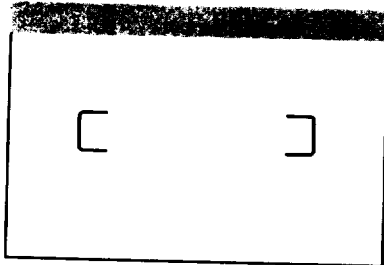

Panoramic format picture

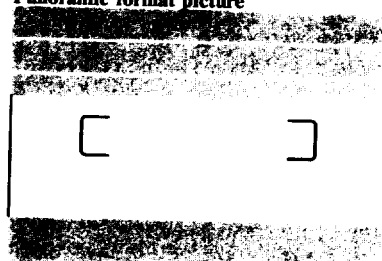

Autofocus frame

The autofocus frame of this camera varies in three steps in accordance with the focal length you have set. Focus on the subject within the autofocus frame. The autofocus frame is widened when the lens is zoomed toward the telephoto 140mm side.

Multi (5-points) focusing

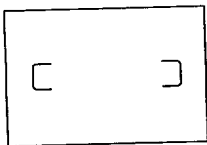
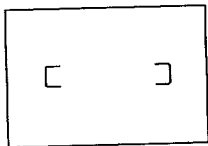
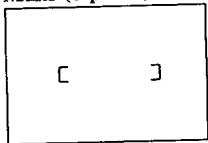

Spot focusing

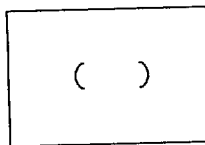
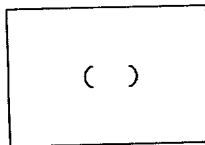
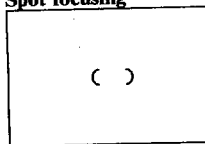



LAMP INDICATIONS

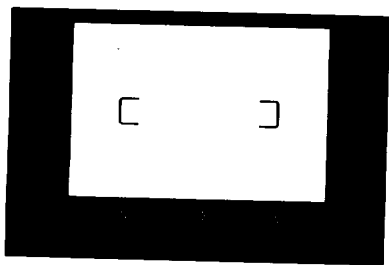

When you depress the shutter release button halfway down, the lamp ●, ● and/or ● lights up or blinks as shown above.

- Green lamp : When the subject is in focus, it will light up to indicate that you can take the picture; when the subject is not in focus, it will blink, indicating that you cannot take the picture because the camera-to-subject distance is too close or is a hard-to-autofocus subject. See page 23.
- Red lamp : When the flash is ready to discharge, it will light up. When the flash is being charged, it will blink.

- Infinity-landscape lamp : When the infinity-landscape mode is set, it will light up.

Note:

- If the subject is too close, the green lamp blinks. Adjust the camera-to-subject distance so that the green lamp lights continuously, then release the shutter. The shutter can be released even it is blinking. In this case, the camera will not focus properly.

Focus aid illuminator

In low light situations and/or hard-to-autofocus subjects, the red light is automatically projected to assist the autofocus system when the shutter release button is depressed halfway down.



ORDINARY PHOTOGRAPHY

When the power is switched on, the camera automatically selects the Auto and Single-Frame Shooting modes. These modes are used for taking ordinary pictures. The built-in flash will discharge automatically when the subject is poorly illuminated.

- When the LCD panel display is different from the one mentioned above (which indicates that other modes are set), switching power OFF and then ON restores the Auto and Single-Frame Shooting modes.

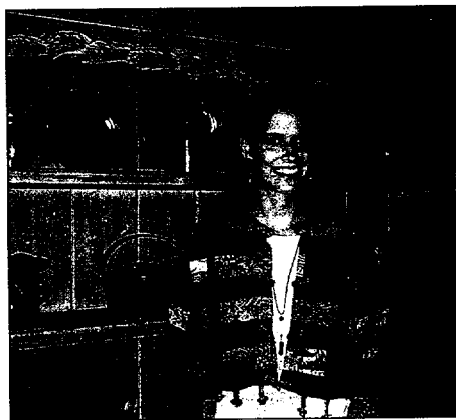

- When the built-in flash automatically discharges, the camera uses a shutter speed in the range from approx. 1/40th (38mm wide-angle) to 1/115th sec. (tele photo 140mm) when an ISO 400 film is used.

6

DIOPTER ADJUSTMENT

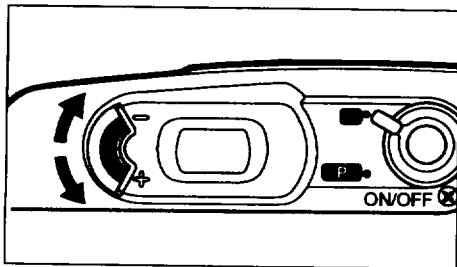

Aim the camera toward a bright subject. While looking through the viewfinder, rotate the diopter adjustment dial to the right or left until the autofocus frame appears in the sharpest focus.

- Be sure to adjust the diopter before use.

7

AUTOMATIC LCD ILLUMINATOR

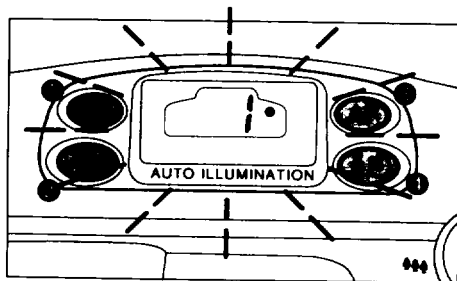

In low light situations, the illuminator of the LCD panel lights up when any one of the red-eye reduction, landscape mode, or drive button is depressed. If one of these buttons is kept depressed for longer than 2 seconds, the illuminator of the LCD panel lights up anytime when you wish to use it.



TAKING PICTURES



1 Composing the scene

After zooming the lens and composing your scene, focus on the subject with the autofocus frame in the center of the viewfinder.

- This camera uses the multi focus system to focus the lens on the subject. Even if the subject is slightly off the center of the autofocus frame, the subject will easily be brought into focus.
- To focus on a particular spot in the autofocus frame, select the spot AF mode. See page 38.
- If the autofocus window is dirty, the autofocus may not function properly.

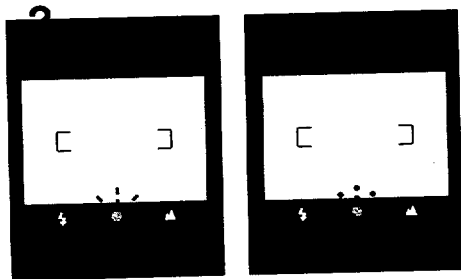

2 Checking the lamp indication

Depress the shutter release button halfway down. When the subject is infocus, the green lamp will light up. The green lamp blinks when the camera is not able to obtain proper focus for one of the following reasons.

- ① The subject is too close. Extend the camera-to-subject distance until the green lamp is lit continuously.
- ② The subject is difficult to autofocus. See page 23.
- When the subject is difficult to focus, the autofocus frame also blinks.

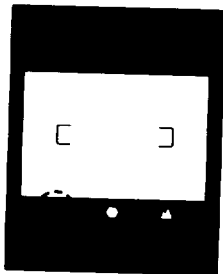
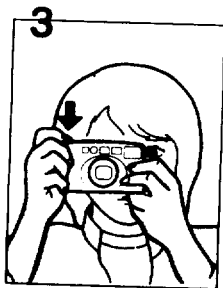

3 Shooting

Depress the shutter release button fully, and the shutter will be released. Then, the film automatically advances to the next frame.

Notes:

- When the shutter is released, the self-timer lamp momentarily lights up to indicate that a picture has been taken.
- If you wish to focus on another subject, lift your finger from the shutter release button and depress the shutter button halfway down again.
- The shutter cannot be released while the lens is zooming.

Automatic Flash Emission

When taking pictures in low light, the flash will automatically discharge. When the shutter release button is depressed halfway down in low light, the red lamp will light up, indicating the flash is ready to discharge. If the red lamp blinks, this indicates that the built-in flash is being charged and the shutter cannot be released. Therefore, make sure that the red lamp is lit continuously before taking pictures.

Red-eye

Shooting portraits with the flash may result in "red-eye", the red dot in your subject's eye. This camera includes a red-eye reduction flash function, which reduces the red-eye phenomenon by using pre-flash. See page 26 and 27 for details.

Flash effective ranges (Nega-color film used)

Lens	ISO	Flash effective ranges (Nega-color film used)		
		100	200	400
38mm (◆◆◆)		0.73~4.5m (2.4-14.8ft)	0.73~6.3m (2.4-20.7ft)	0.73~9.0m (2.4-29.5ft)
140mm (◆)		1.0~2.4m (3.3-7.9ft)	1.0~3.3m (3.3-10.8)	1.0~4.7m (3.3-15.4ft)

HARD-TO-AUTOFOCUS SUBJECTS

The autofocus system is highly precise, but not perfect. Some subjects may not focus as you wish. In such a case, use the focus-lock technique on a subject near the actual one and equidistant from the lens. See page 39. The subjects which may fool the autofocus system include:

- a) Extremely low-contrast subjects such as a white wall or blue sky in the autofocus frame.
- b) Subjects which don't reflect much light in the autofocus frame.
- c) Subjects with horizontal lines or with finely complex or detailed patterns in the autofocus frame.
- d) Subjects which are moving too fast.
- e) Multiple subjects in foreground of the autofocus frame.
- f) Subjects positioned against reflected light or strong backlight or with extremely bright background.

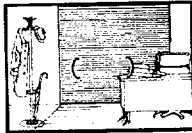
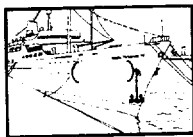

UNLOADING FILM

Remove the film from the camera in the shade or by using your body to shade the camera

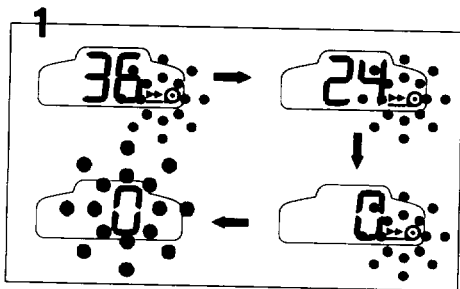

1 Rewinding the film

After you have exposed the last frame of the roll, the lens retracts and the film rewinds automatically. Then, the motor stops, and (0) blinks as shown to indicate that the film has been rewound.

- A 24-exposure roll of film takes about 20 seconds to be rewound.
- During rewinding, the exposure counter counts frame numbers in reverse.
- The entire roll of film including the film leader is always rewound into the cartridge to prevent any part of the film being exposed to light.

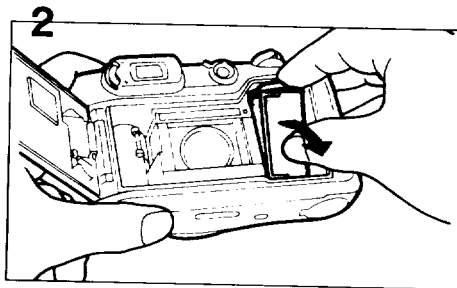

2 Unloading the film

To unload the film, open the back cover, and remove the cartridge from the chamber by pulling the top out first with your finger.

Notes:

- The shutter may be released a frame or two even after the specified number of frames have been used up as indicated by the number of shots shown on the film canister. If this occurs, these extra frames may be lost in the processing.
- Never open the back cover until the whole film roll is rewound.

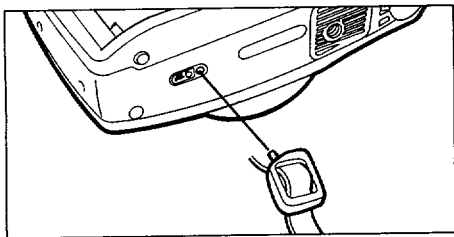

Rewinding a film in mid-roll

If you wish to unload a film before exposing all the frames, push the auxiliary rewind button with the protrusion part of the strap cramp; the lens retracts and then film rewinding starts. When rewind is completed, the motor stops, and () blinks, indicating that the back cover may be opened safely.

HOW TO SELECT MODES / RED-EYE REDUCTION FLASH MODE

TAKING BETTER PHOTOGRAPHS

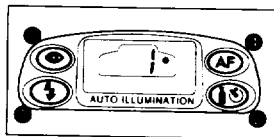

To set various exposure modes, depress the mode button ④.

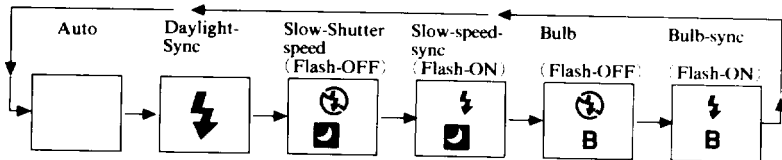

Turn the power on by depressing the main switch button.

- To set various required modes, depress the button ④, ⑤ and/or ⑥ each time.
- For normal use, set the Auto, Single frame and Multi focus modes. When the power is switched on, the Auto, Single frame and Multi focus modes are automatically set.

Red-Eye Reduction Flash Function

To reduce the red-eye phenomenon in the picture, depress the red-eye reduction flash button (⑤) ④. With this mode, the flash discharges two consecutive times, reducing the appearance of the red-eye effect. To cancel this mode, depress the red-eye reduction button again.

- In dark light situations, the illuminator for the LCD panel lights up automatically when one of four buttons next to the LCD panel is depressed. See page 20.

To set various shooting modes, depress the drive button ②.

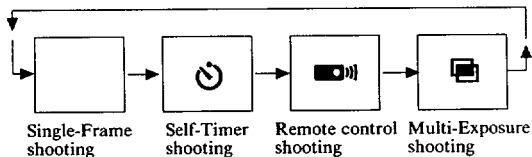

- In any exposure and/or shooting mode, if the button ② is depressed after the shutter is released, the normal shooting mode is returned automatically.

To set various focusing modes, depress the AF/Infinity-Landscape button ④.

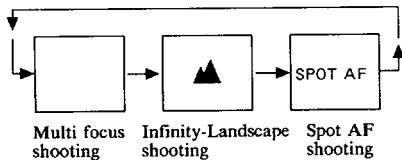

Red-eye phenomenon in flash photography

When a picture is taken using a flash, a subject's eyes may appear red in the print. This phenomenon is caused by the reflection of the electronic flash in the retina. It can be reduced when the surrounding of the subjects are brightened, or shooting distance is shortened or by employing the red-eye reduction flash feature.

DAYLIGHT-SYNCHRO SHOOTING

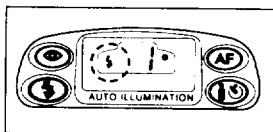

Depress the mode button until the () symbol appears on the LCD panel. The flash will discharge in both dark and bright conditions.

When a portrait is taken with the subject in a backlight situation, the front of the subject may be cast in shadow. In such a case, use the Daylight-Synchro Shooting mode (Flash-ON mode) within the flash-effective range to take pictures. This will ensure that a picture is well exposed without any shadow. When you wish to discharge the flash, use this mode. In this mode, the flash will always discharge.

Notes:

- Make sure that the red lamp in the viewfinder is lit when the shutter release button is depressed halfway down before shooting. The red lamp blinking indicates that the flash is being charged.
- Make sure you're within the flash effective range even when you use the built-in flash as a fill-in flash in daylight. See page 22.



Without Daylight-Sync



With Daylight-Sync

TAKING PICTURES AT A SLOW SHUTTER SPEED

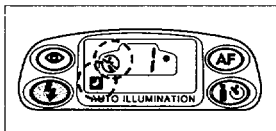

Slow Shutter Speed (Flash-OFF)

Depress the mode button until the (⚡) symbol appears on the LCD panel. In

this mode, the flash does not discharge, and a picture is taken at a slow shutter speed up to approx 2 seconds. Use it in places where the flash photography is prohibited, such as in theaters and museums. Furthermore, this mode is also useful for a natural existing light effect in low ambient photography.

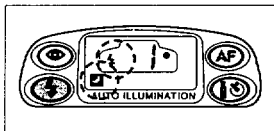

Slow-Speed-Synchro Shooting (Flash-ON)

Depress the mode button to set the slow-shutter-sync mode until the

(⚡) symbol appears on the LCD panel. It is possible to photograph subjects and background in a balanced way (as shown in the photo) by using the built-in flash to properly expose the foreground subject and a slow-speed to expose the low light background.

Notes:

- When shooting in low light, the shutter speed gets slower, and camera shake is likely to blur your picture. Use of a tripod is recommended.
- Make sure you are within the flash effective range even when you use the built-in flash as a fill-in flash in daylight. See page 22.



With Slow-Speed-Synchro

BULB, BULB-SYNCHRO SHOOTING

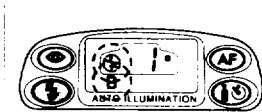

Bulb mode (⊕ B)
Depress the mode button until (⊕ B) appears on the LCD panel. The shutter remains open up to 5 minutes

as long as the shutter release button is held down. This mode is useful for long exposures required for shooting fireworks and night scenes, for example. When using this mode, the camera should be mounted on a tripod so that the camera will be steady.



Bulb-synchro mode (⚡ B)
If the mode button is depressed, (⚡ B) appears on the LCD panel and the Bulb-synchro

mode is set. This lets you use the flash in addition to the Bulb mode, so you can take a portrait photograph with a night scene in the background, for example.

- Make sure you're within the flash effective range even when the Bulb-synchro mode is in use.

See page 22.



Bulb mode, approx. 3-sec. (ISO 400)

SELF-TIMER PHOTOGRAPHY

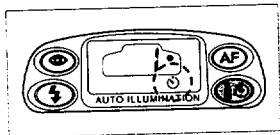

Self-Timer

Use the self-timer if you wish to get in the picture. Use of a tripod is recommended. Depress the drive button

until (⌚) appears on the LCD panel.

Focus on the subjects first by depressing the shutter release button fully. The shutter will be released in about 10 seconds. When the Self-Timer is working, the Self-Timer symbol (⌚) blinks on the LCD panel, and the Self-Timer lamp lights up. The lamp starts blinking 3 seconds before the shutter is released, letting you know when to smile.

Notes on the self-timer shooting

- Keep in mind that when starting the Self-Timer while standing in front of the camera may not focus the subject.
- To cancel the self-timer at any time after it's been activated, push the main switch. In this instance, the power will not be turned off.

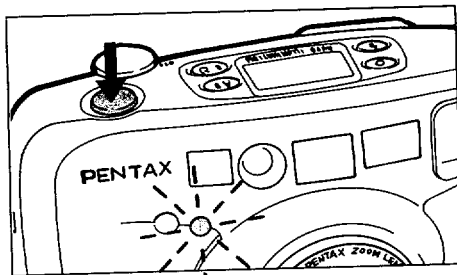

- When you want to use the flash with the self-timer, ensure that the red lamp is lit indicating the flash has been charged before operating the self-timer.
- If the battery is exhausted, the self-timer operation may not be completed once started. In this case, replace the battery.
- When the Bulb mode is used in combination with the self-timer, a shutter speed of approx. 1/2 sec. is automatically selected.

USING WIRELESS REMOTE CONTROL OPTION

If you have purchased the optional wireless remote control, read this section. The wireless remote control allows you to trip the shutter at a distance. The shutter will be released in 3 seconds if the remote control's button is depressed.

- Use a tripod when shooting with the wireless remote control.
- When the remote control is used to take pictures, the Single-Frame mode can be used in combination with any of the exposure modes. The Self-Timer shooting mode and Multi-Exposure Shooting mode cannot be used in this case.
- Use the remote control to take pictures in the Bulb mode to avoid camera shake. While the remote control's shutter release button is held down, the shutter remains open up to a max. of 5 minutes.

Remote Control Shooting mode

Depress the camera's drive button each time until () symbol appears on the LCD panel.

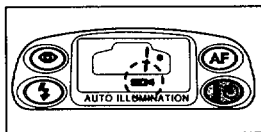

Name of parts

Shutter release button

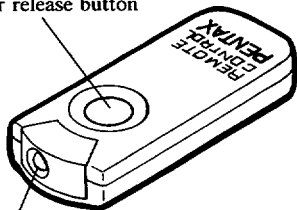

Remote Control Transmitter

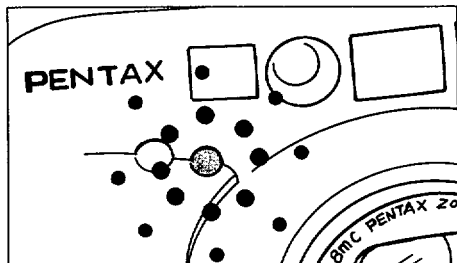

Blinking Lamp

When the Remote Control Shooting mode is set on the camera, the self-timer lamp on the front of the camera blinks slowly, indicating that you can take pictures with the aid of a remote control.

- When the camera is set in the Remote Control Shooting mode and left unused for 5 minutes, the lens automatically retracts itself to save power and Single-Frame will be set.

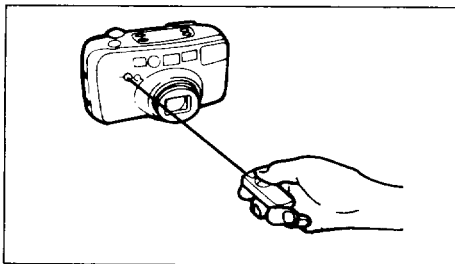

- Focus cannot be locked when the remote control is in use. The subject framed in the autofocus frame will be in focus when the remote control's shutter release button is depressed.

Taking Pictures

Compose the scene and frame the subject with the autofocus frame. Aim the remote control transmitter towards the remote control receiver on the camera, and then depress the remote control's shutter release button fully to release the shutter.

- The self-timer lamp blinks rapidly for 3 seconds and then the shutter is released.
- If the shutter is released by the camera's release button, picture will be taken in the ordinary shooting mode.

Operating Distance of the Wireless Remote Control from the camera's front: within approx. 5m(16.5ft) straight in front of the camera

- The remote control may not work in a backlight situation. In this case, use the camera's shutter release button in the Self-Timer mode to take pictures.
- The remote control does not work while the built-in flash is being charged.

Battery life on the Remote Control

About 30,000 commands can be issued using the Remote Control with a battery installed. If the battery is exhausted, please have it replaced at your local Pentax Service center (there is a charge for this service).

MULTI-EXPOSURE SHOOTING



Multi-Exposure mode will disengage the film advance, letting you superimpose images on a single frame for fantastic illusions. Your imagination can produce striking creative effects.

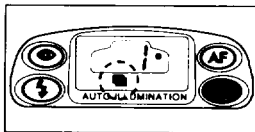

Procedure

1. Depress the drive button until the symbol (☐) appears on the LCD panel.
2. Depress the shutter release button to shoot an initial exposure. The film will not advance, the frame counter indication and (☐) blink on the LCD panel to indicate that you are in the Multi-Exposure mode.
3. Recompose the frame, and depress the shutter release button to shoot the second shot, the film will advance and the Single Frame shooting will be restored.

Notes:

- To expose two or more, depress the drive button until the (☐) remains lit after the step 2 above, and then depress the shutter release button.
- The date will be exposed in step 3 above on the DATE model.
- Repeated multiple exposures tend to overexpose a frame, so it is recommended that you expose a frame just twice or 3 times at most.
- When using the Multi-Exposure mode, you usually get the best results with dimly-lit background, such as night scenes.

INFINITY-LANDSCAPE SHOOTING

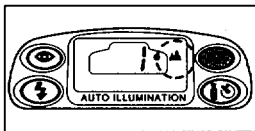

When you wish to take a sharp picture of a distant landscape or a distant subject through a window, the Infinity-Landscape mode allows you to capture distant scenery with clarity.

Depress the AF/Infinity-Landscape button and (▲) appears on the LCD panel.

- (▲) will light up in the viewfinder when the shutter release button is depressed halfway down in this mode.
- (○) will not light up in the viewfinder when the shutter release button is depressed halfway down in this mode.



- After the picture is taken by fully depressing the shutter release button, this mode is canceled.
- The flash will not discharge in the Auto Exposure mode even in dark light situations.

SPOT AF SHOOTING

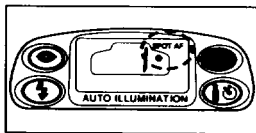

Select the Spot AF mode to focus on a particular spot in the frame.

Switch to Spot AF mode

Depress the AF/Infinity-Landscape mode button so that the (SPOT AF) appears on the LCD panel indicating that you are in the Spot AF mode.

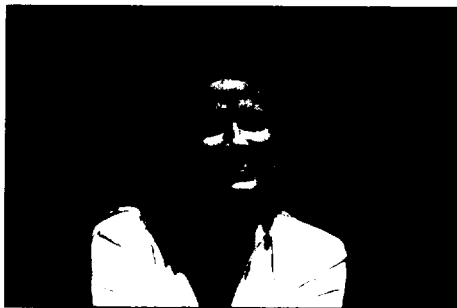

Focus on the subject

Focus on the subject with the Spot AF frame () in the center of the viewfinder.

The autofocus frame automatically varies as you zoom the lens. See page 17.

- When the main subject is off the autofocus frame in the center of the viewfinder, use the focus-lock technique. See page 39.

FOCUS-LOCK SHOOTING

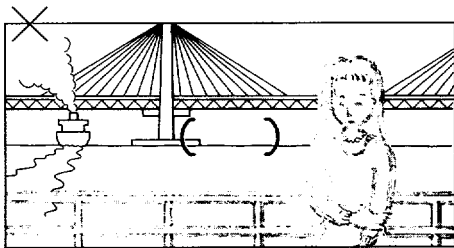

If you shoot without positioning the autofocus frame (C) on the main subject as shown above, only the background will be in focus. When the main subject is off the autofocus frame in the center of the viewfinder, use the focus-lock technique. (Focus lock is the function to lock focus.)

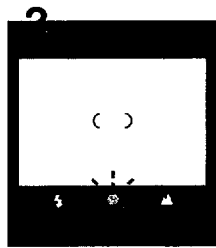
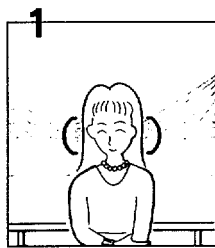

- 1 Focus on the subject with the autofocus frame (C).
- 2 When the shutter release button is depressed halfway down, the green lamp in the viewfinder lights up and the exposure and focus are temporarily locked.

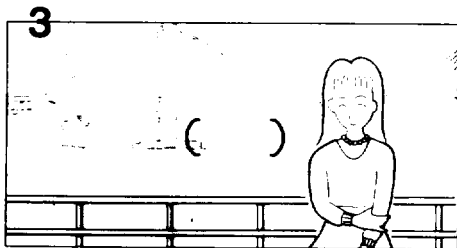

3 While depressing the shutter release button halfway, re-aim the camera or recompose the picture, then release the shutter.

Note:

- You can release focus lock simply by lifting your finger from the shutter release button.

TAKING PANORAMIC FORMAT PICTURE

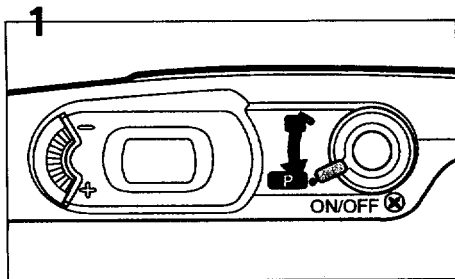

You can switch between the panoramic format and standard format picture taking mode in the middle of the roll by moving the panorama mode switch. The panoramic format picture allows horizontally positioned dynamic pictures to be taken (13x36mm on film).

1 Switching to the panoramic format picture

Move the panorama mode selector switch to (P) to select the panoramic format mode.

- When the format is switched to panorama, the viewfinder switches to the horizontal panoramic format frame.

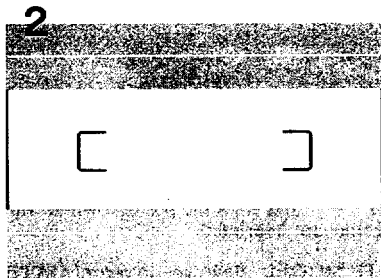

2 Taking a panoramic format picture

Compose the scene within the panoramic format frame, and then fully depress the shutter release button to take a panoramic format picture.

- When taking panoramic format pictures in the close distance, the picture area in the viewfinder is automatically changed and compensated. Make sure to compose the scene within the compensated panoramic format frame. See page 16.



The mark " — " indicates the position where the data and time are imprinted.

The DATE MODEL allows you to record DATE information in the panoramic mode in a similar manner to the standard picture taking mode. See "DATE MODEL" on page 44 for details. The dating unit automatically switches the DATE position between the standard and panorama according to the format mode selected.

NOTES ON THE DEVELOPMENT OF PANORAMIC FORMAT PICTURES

- When developing the film, if you have taken only panoramic format pictures on the entire roll of film, tell the clerk at the processing lab to develop the film with only the panoramic format. If there are both panoramic and standard format photographs on the film, ask the clerk to develop the film with both standard and panoramic format.

- The development of panoramic format pictures is a more time-consuming and expensive process than that of standard pictures. Please consult the processing lab for more details.
- Panoramic format processing facilities differ depending on the area and requirements. Your local film processor or camera dealers will advise you on all the options to you.
- With panoramic format pictures, only the middle area of the frame is exposed. The number of exposures available in the panoramic format is equivalent to that of the standard photo size.



- When the panoramic format picture is printed with a standard size format, the black cropped areas will appear on the top and bottom of the picture.

DATE MODEL

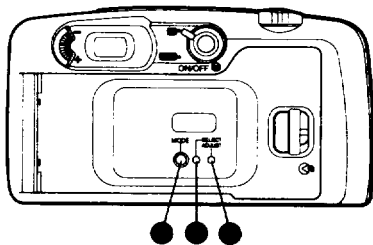

If you purchased the DATE model, read this section. The DATE model records dates up to the year 2019 on pictures.

- ❶ **MODE** MODE BUTTON
- ❷ **SELECT** SELECT BUTTON
- ❸ **ADJUST** ADJUST BUTTON

Switching the Mode

Press the MODE button ● with your finger, the mode on the LCD panel switches as shown in the chart.

Notes:

- "----" indicates no data will be imprinted.
- "M" on the LCD panel indicates "Month".
- Use the strap cramp's protrusion to depress the SELECT and ADJUST buttons.

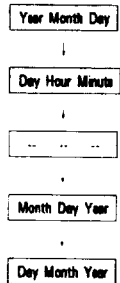

* The date in the picture above is simulated.

Correcting the date

1. Depress the SELECT button ② to make a different category of digits on the LCD panel you want to change blink.
 2. Depress the ADJUST button ③ to change digits of the specified category you chose with the SELECT button ②. Digits increase by one each time you depress the ADJUST button ③. Holding down the button will advance digits continuously.
 3. After the data has been adjusted, depress the SELECT button ②. The bar mark (-) appears on the LCD panel, indicating that data imprinting choices are possible.
- The blinking “:” allows precise fine-tuning of the internal clock to the beginning of a specified minute. To do so, depress the mode button ① until “Day-Hour-Minute” digits appear and then depress the SELECT button ② to make the “:” blink. Then depress the adjust button ③ in sync with a time signal.
 - If you release the shutter while the blinking data is being corrected, the data cannot be imprinted.



Operational precautions

The data on the LCD panel is imprinted on each frame you expose.

- “Year-Month-Day” and “Day-Hour-Minute” cannot be imprinted at the same time.
- As you release the shutter, the bar (-) mark on the display blinks for a few seconds, indicating the data has been imprinted.
- Move the panorama mode selector switch to the right or left to switch the imprint mode between panorama and standard.
- The dating unit automatically switches the imprint mode between the standard and panorama according to the format mode selected.
- If there is a white or yellow object in the corner of the picture where the data is imprinted, the data may be difficult to read. When composing your photographs, try to avoid brightly-colored subjects in that corner.

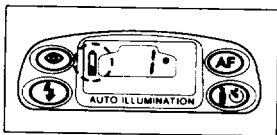
BATTERY EXHAUSTION WARNING



When the battery is nearly exhausted, the battery symbol () appears on the LCD panel to warn you. Replace the battery as soon as possible. When () starts blinking, no operations can be performed.

Battery life (using 24-exposure film rolls):

Approx. 15 rolls using flash 50% of the time (using the CR123A battery and under Pentax testing conditions). Actual battery life/performance may vary drastically depending on usage of Auto-Focus, Power Zoom, Flash and external conditions such as temperature and freshness of the battery.

Notes on replacing the battery:

- Ensure that the power is off before replacing the battery.
- The battery is used by both the camera body and the data function on the DATE model to keep constant track of time. After the battery is replaced, correct the time and date. See page 45.
- The no. of exposed frames are memorized and unchanged even if the battery is replaced.

INSTALLING/REPLACING BATTERY Use one 3V lithium battery (CR-123A or DL-123A)

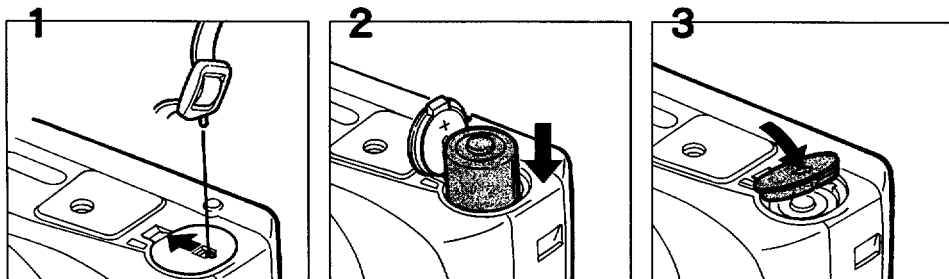

Ensure that the power is off before replacing the battery.

- 1 Open the battery chamber cover by pulling the cover lock in the direction of the arrow with the strap clamp's protrusion.
- 2 Insert one lithium battery with the plus/minus (+/-) sides matching the indications in the battery compartment.

3 Close the battery chamber cover. Ensure that the cover is locked with a click.

- If the battery is correctly loaded, the zoom lens moves slightly and the motor operates for a few seconds.
- On the DATE MODEL, the data is initialized to 87/1/1 when the battery chamber cover is opened. See page 45 for correcting the data.

TROUBLESHOOTING

What appears troublesome may be easily remedied. Here are some problems that may occur and their remedies.

Symptoms	Causes and Remedies
1. The shutter cannot be released.	<ul style="list-style-type: none">• Is the main switch turned off? If so, turn it on. See page 8.• Is the battery exhausted? Replace it or insert new battery if it is exhausted. See page 46.• Is (L) blinking on the LCD panel? If so, the film has been used up. Insert a new roll. (See page 24.)
2. My printed pictures don't look very clear.	<ul style="list-style-type: none">• Did you position the autofocus frame on your subject? See page 21.• Did you obstruct the autofocus window with your fingers, hair or other object when you depress the shutter release button? See page 10.• Is the autofocus window dirty? Wipe it off. See page 21.
3. Zoom lens retracted automatically (the power is turned off automatically)	<ul style="list-style-type: none">• Did you leave the camera unused for over 3 minutes after the main switch was turned on? The power is automatically switched off if the camera is left unused for over 3 minutes. See page 9.• When the camera is on and left unused for more than 5 minutes in the Remote Control shooting mode, the camera automatically switches itself off to save battery power. Push the main switch again to turn it on. See page 33.

Symptoms	Causes and Remedies
4. The Remote Control does not operate.	<ul style="list-style-type: none"> The operable distance of the Remote Control is approx. 5m from the front. See page 35. The Remote Control may not operate in a backlit situation. See page 35. The flash is being charged. Wait until it fully charges. See page 35. Is the battery for the remote control exhausted? See page 35.
5. The flash discharges, though it is not dark.	<ul style="list-style-type: none"> The flash discharges automatically in a backlit situation. See page 19. Daylight sync mode has been set. See page 28.
6. The (H) or (U) mark is displayed on the LCD panel.	<ul style="list-style-type: none"> If either mark disappears when the zoom lever is moved, the camera is ready for use. The camera may be defective if either mark appears often.



Flash effective ranges other than ISO 100, 200 or 400 (Nega-color film used)

Lens \ ISO	25	50	100	1600	3200
38mm (◆◆◆)	0.73-2.2m (2.4-7.2ft)	0.73-3.2m (2.4-10.5ft)	0.84'-12.7m (2.8'-41.7ft)	1.2'-18.0m (3.9'-59.0ft)	1.7'-25.4m (5.6'-83.3ft)
140mm (◆)	1.0-1.2m (3.3-3.9ft)	1.0-1.7m (3.3-5.6ft)	1.0-6.7m (3.3-22.0ft)	1.0-9.4m (3.3-30.8ft)	1.0-13.3m (3.3-43.6ft)

* With high speed film, overexposure may occur at close range due to the film's high speed.

SPECIFICATIONS

Type:	35mm fully automatic leaf-shutter with built-in zoom lens and auto flash
Film:	Auto film speed setting with 35mm perforated DX-coded film with ISO rating from 25-3200 (1EV step). Non-DX coded films are automatically set to ISO25
Format:	24x36mm (13x36 in panoramic format)
Film loading:	Auto film loading. Closing the back cover will automatically wind the film to first exposure.
Film winding:	Auto film-winding: single frame advance mode.
Film rewinding:	Auto start at the end of roll. Auto stop upon completion of rewinding. Rewinding time: approx. 20 sec. with 24-exposure film. Rewinding in mid-roll provided.
Frame number:	Automatic readout of successive frame numbers in ascending order when shooting, and descending order when rewinding.
Lens:	Pentax power zoom 38-140mm f/4.1-10.2 9 elements in 7 groups, Angle of view: 59° - 17.5°.
Focusing system:	Pentax phase-matching passive multi (5 points) autofocus system. Range: 1m(3.3ft)-infinity at Tele 140mm, 0.73m(2.4ft)-infinity at wide-angle 38mm. Maximum magnification approx. 1/6.9X. Focus lock is provided. Infinity-landscape mode (focus is fixed to infinity). Focus aid illuminator is automatically emitted in low light / or hard-to-autofocus subject.
Zooming:	Electronic zoom
Shutter:	Programmed AE electronic shutter with speed approx. 1/400-2 sec. Bulb: 1/2 sec. - 5min, Electromagnetic release.
Self-timer:	Electronic red lamp indication. Approx. 10 sec. Cancellation after activation is possible.
Viewfinder:	Actual image zoom viewfinder with LCD indication, 83% of field of view ratio, Magnification: 0.45X (38mm WIDE) - 1.37X (140mm TELE), Diopter -3 to +1D, AF frame varies in accordance with focal length (blinking when subject is hard-to-autofocus subject), Picture frame, Close distance compensation frame, Panoramic format picture area, Green lamp lighting (○): in-focus signal, Green lamp blinking: When subject is too close and/or hard-to-autofocus subject, Red lamp lighting (⚡): Flash-ready status, Red lamp blinking: Flash being charged, (▲) lighting: Infinity-Landscape shooting.

Exposure control:	Programmed auto-exposure control with multi(6)-segment metering system. Range: EV9.6-EV17 at 38mm WIDE EV13-EV18 at 140mm TELE in Auto or Daylight-Synchro mode (ISO 100), EV3.1-EV17 at 38mm WIDE EV5.6-EV18 at 140mm in Slow-Shutter-Speed mode, Automatic exposure compensation in a backlit situation.
Multi-Exposure:	Multiple exposure function provided.
Flash:	Built-in flash with red-eye reduction mode, Automatic flash emission in low-luminance or a backlit situation, Flash ON=Day-light Synchro/Slow-Shutter-Speed Synchro (up to 2 sec.),Flash-OFF=Flash override, Bulb-Synchro 1/2 sec.- 5min.
Flash effective range:	0.73-9.0m (38mm WIDE), 1.0-4.7m (140mm TELE) (ISO 400 film used).
Flash recycling time:	Approx. 5 sec. under Pentax testing conditions.
Remote control:	Infrared wireless remote control, 3-second delay shutter release, Effective range: Closer than 5m when projected from the camera's front.
Power source for Remote Control:	One lithium battery CR1620 (replaced by Pentax Service facility)
Size & weight for Remote Control:	22.0(W) x50.0(L) x9.5(D)mm (0.9"x2.0"x0.4"), 9 g (0.3oz) including battery
Battery life:	Approx.15 rolls of 24 exposure film when 50% of shooting uses flash (under Pentax testing conditions)
Battery exhaustion warning:	() appears on the LCD panel, Shutter is locked when () is blinking.
Size & Weight:	132(W)x74.5(H)x61.5(D)mm (5.2"x2.9"x2.4") 315 g (11.1oz) without battery
DATE MODEL	
Date mechanism:	Crystal quartz controlled; LCD with digital clock, auto calendar up to 2019. Possible to imprint both standard and panoramic format frames.
Imprinting mode:	"Year,Month and Day", "Day,Hour and Minutes", "— blank", "Month, Day and Year" or "Day, Month and Year".
Size & Weight:	132.0(W)x74.5(H)x64.5(D)mm (5.2"x2.9"x2.5") 325 g (11.5oz) without battery

SPECIFICATIONS ARE SUBJECT TO CHANGE AT ANY TIME WITHOUT NOTIFICATION OR ANY OBLIGATION ON THE PART OF THE MANUFACTURER.

WARRANTY POLICY

All Pentax cameras purchased through authorized bona fide photographic distribution channels are guaranteed against defects of material or workmanship for a period of twelve months from date of purchase. Service will be rendered, and defective parts will be replaced without cost to you within that period, provided the equipment does not show evidence of impact, sand or liquid damage, mishandling, tampering, battery or chemical corrosion, operation contrary to operating instructions, or modification by an unauthorized repair shop. The manufacturer or its authorized representatives shall not be liable for any repair or alterations except those made with its written consent and shall not be liable for damages from delay or loss of use or from other indirect or consequential damages of any kind, whether caused by defective material or workmanship or otherwise; and it is expressly agreed that the liability of the manufacturer or its representatives under all guarantees or warranties, whether expressed or implied, is strictly limited to the replacement of parts as hereinbefore provided. No refunds will be made on repairs performed by non-authorized Pentax service facilities.

Procedure During 12-month Warranty Period

Any Pentax which proves defective during the 12 month warranty period should be returned to the dealer from whom you purchased the equipment or to the manufacturer. If there is no representative of the manufacturer in your country, send the equipment to the manufacturer, with postage prepaid. In this case, it will take a considerable length of time before the equipment can be returned to you owing to the complicated customs procedures required. If the equipment is covered by warranty, repairs will be made and parts replaced free of charge, and the equipment will be returned to you upon completion of servicing. If the equipment is not covered by warranty, regular charges of the manufacturer or of its representatives will apply. Shipping charges are to be borne by the owner. If your Pentax was purchased outside of the country where you wish to have it serviced during the warranty period, regular handling and servicing fees may be charged by the manufacturer's representatives in that country. Notwithstanding this, your Pentax returned to the manufacturer will be serviced free of charge according to this procedure and warranty policy.

In any case, however, shipping charges and customs clearance fees are to be borne by the sender. To prove the date of your purchase when required, please keep the receipts or bills covering the purchase of your equipment for at least a year. Before sending your equipment for servicing, please make sure that you are sending it to the manufacturer's authorized representatives or their approved repair shops, unless you are sending it directly to the manufacturer. Always obtain a quotation for the service charge, and only after you accept the quoted service charge, instruct the service station to proceed with the servicing.

This warranty policy does not apply to Pentax products purchased in the U.S.A., UK, or Canada. The local warranty policies available from Pentax distributors in those countries supersede this warranty policy.

LCD (Liquid-crystal display)

- When the LCD is exposed to high temperatures over about 60°C, it may blacken, but when the temperature normalizes, it will return to normal.
- The LCD may also slow down in response to lower temperatures, but this is a normal characteristic of an LCD.

NAMES OF WORKING PARTS

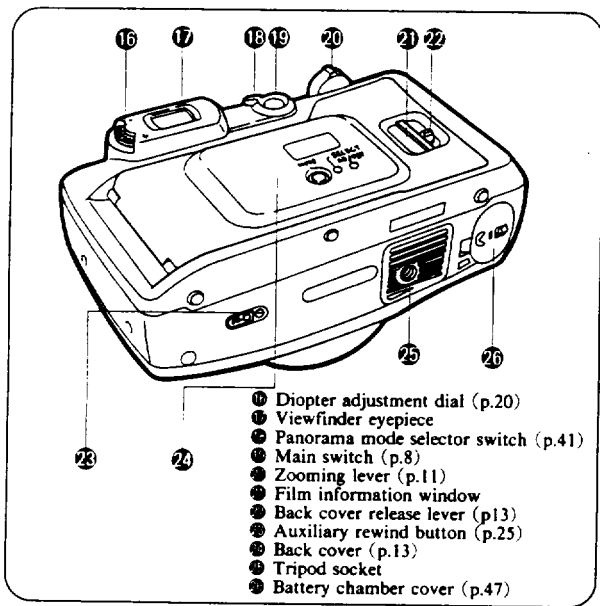

FOR YOUR REFERENCE, KEEP THIS CARD WITH THE CAMERA.

PENTAX IQZOOM 140

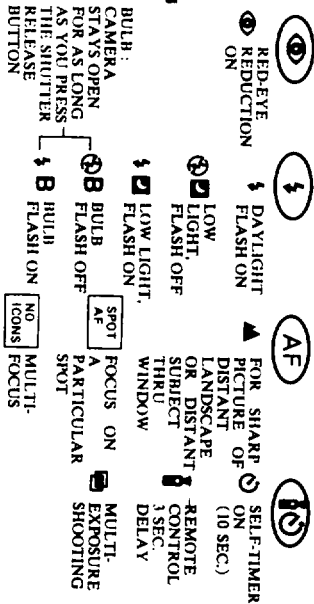

* CAMERA FLASHES AUTOMATICALLY WHEN NO ICONS APPEAR

**FOR YOUR REFERENCE, KEEP
THIS CARD WITH THE CAMERA.**

PENTAX® IQZ^{zoom}140

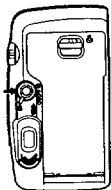

3 PUSH ON MAIN SWITCH
TO TURN ON POWER.



WHEN SUBJECT IN FINDER IS NOT
CLEARLY SEEN, ROTATE DIAL TILL
AF FRAME APPEARS IN SHARP.

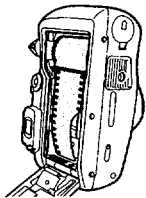

2 LOAD FILM AND CLOSE
BACK COVER

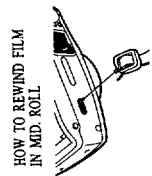

HOW TO REWIND FILM
IN MID. ROLL

PUSH
AUXILIARY BUTTON.

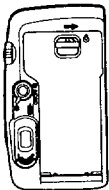

1 OPEN BACK COVER
USING RELEASE LEVER

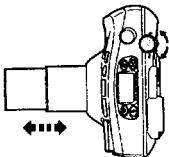

4 OPERATE ZOOMING
LEVER TO FRAME

LCD PANEL

All indications will not actually appear simultaneously as shown.

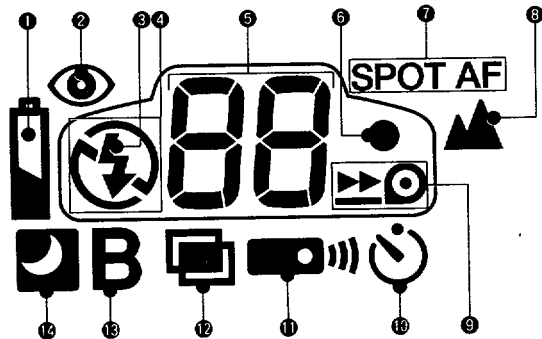

- | | |
|--|--|
| 1 Battery Exhaustion
Warning (p.46) | 8 Infinity-Landscape mode
(p.37) |
| 2 Red-eye Reduction Flash
mode (p.26,27) | 9 Film Rewind mode (p.24) |
| 3 Flash ON (p.28) | 10 Self-Timer (p.31) |
| 4 Flash OFF (p.29) | 11 Remote Control shooting
mode (p.33) |
| 5 Exposure Counter (p.14) | 12 Multi-Exposure mode
(p.36) |
| 6 Shutter Release Button | 13 Bulb (p.30) |
| 7 Spot AF mode (p.38) | 14 Slow-Shutter-Speed (p.29) |



Asahi Optical Co., Ltd. 11-1, Nagata-cho 1-chome, Chiyoda-ku, Tokyo 100, JAPAN

Pentax Europe n.v. Weveldlaan 3-5, 1930 Zaventem, BELGIUM

Pentax GmbH. Julius-Vosseler-Strasse, 104, D-22527 Hamburg, GERMANY

Pentax U.K. Limited. Pentax House, Heron Drive, Langley, Slough SL3 8PN, U.K.

Pentax France S.A. Z.I. Argenteuil, 12, rue Ambroise Croizat, 95100 Argenteuil, FRANCE

Pentax Benelux B.V. (for Netherlands) Spinveld 25, 4815 HR Breda, NETHERLANDS

(for Belgium & Luxemburg) Weveldlaan 3-5, 1930 Zaventem, BELGIUM

Pentax (Schweiz) AG Industriestrasse 2, 8305 Dietlikon, SWITZERLAND

Pentax Scandinavia AB Falhagsleden 57, 75127 Uppsala, SWEDEN

Pentax Corporation 35 Inverness Drive East, Englewood, Colorado 80112, U.S.A.

Pentax Canada Inc. 3131 Universal Drive, Mississauga, Ontario L4X 2E5, CANADA