

PENTAX[®]

IQZoom ***835***

IQZoom ***835*** DATE

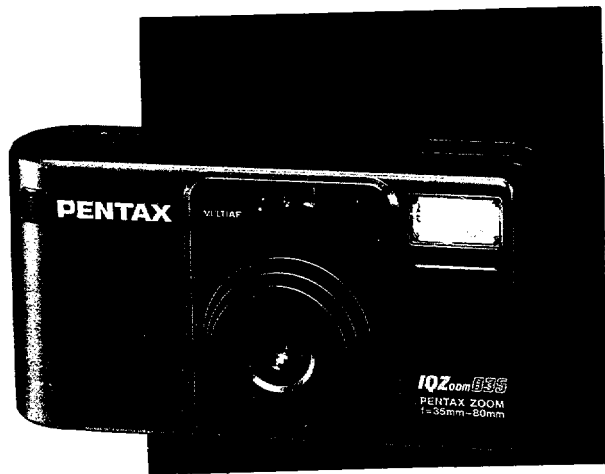





OPERATING MANUAL



Congratulations on your purchase of the PENTAX IQ Zoom 835 and welcome to the world of Pentax zoom compact photography! Your compact, light weight camera is a great companion to preserve your favorite memories. Its built-in 35-80mm zoom lens gives you the freedom to frame everything from breathtaking landscapes to family portraits, even detailed close-ups. The built-in auto flash helps you capture subjects in dimly-lit places or photograph indoor scenes with clarity and brilliance. Also included are panorama/standard format mid-roll switching capability and a wireless remote control feature. Since most of the operation - including film loading, film speed setting, winding/rewinding, focus and exposure control - are automatic, you can take great pictures effortlessly. The DATE model makes it easy to remember the dates when you took pictures.

- Please read this manual carefully before operating the camera to take consistently superior pictures.
- Pay special attention to the cautions and notes in this Operating Manual. Pictures and illustrations shown herein may differ from the camera's appearance.
- Illustrations in this operating manual are DATE MODEL.

Icon indicators in this manual

Operation direction	
Automatic operation	
Attention	
Lamp lighted	
Lamp blinking	
Correct	
Incorrect	

The name of the camera's working parts are listed on the front and back flaps of this manual. Keep the flaps unfolded for quick reference while reading manual.

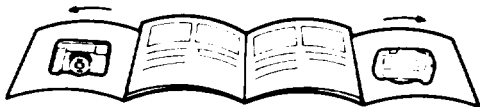

NAME OF WORKING PARTS

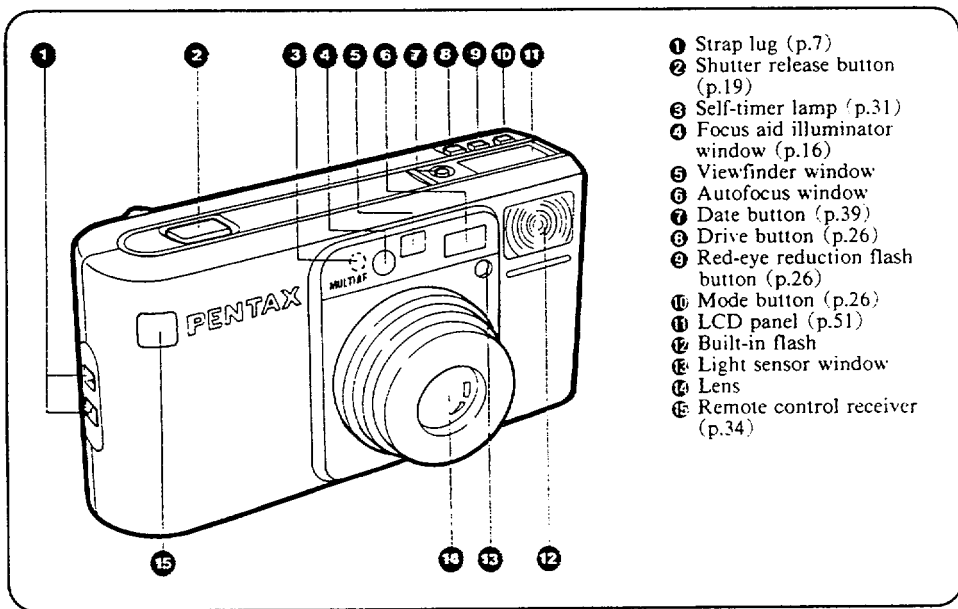

- ① Strap lug (p.7)
- ② Shutter release button (p.19)
- ③ Self-timer lamp (p.31)
- ④ Focus aid illuminator window (p.16)
- ⑤ Viewfinder window
- ⑥ Autofocus window
- ⑦ Date button (p.39)
- ⑧ Drive button (p.26)
- ⑨ Red-eye reduction flash button (p.26)
- ⑩ Mode button (p.26)
- ⑪ LCD panel (p.51)
- ⑫ Built-in flash
- ⑬ Light sensor window
- ⑭ Lens
- ⑮ Remote control receiver (p.34)

OUTLINE OF BASIC OPERATIONS

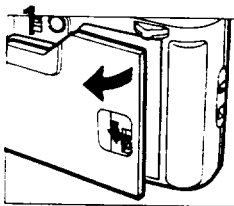

1 Open the back cover (see page 13.).

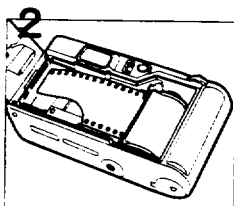

2 Load the film and close the back cover (see page 13.).

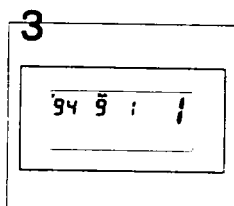

3 The film will automatically advance to the first frame (see page 14.).

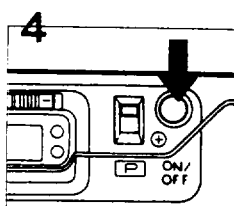

4 Push the main switch button to switch on power (see page 8.).

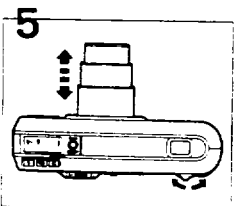

5 Frame your subject and operate the zooming lever to compose the shot (see page 11.).

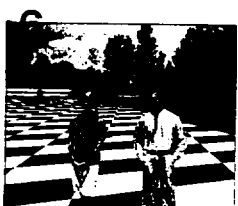

6 Focus on your subject (see page 19.).

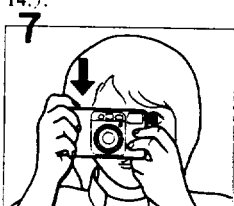

7 Depress the shutter release button. In dark conditions, the flash will discharge automatically (see page 20.).

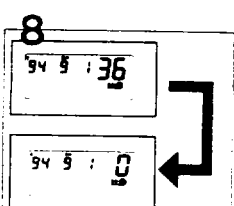

8 When the film is finished, the camera will automatically rewind it (see page 24.).

PRECAUTIONS FOR YOUR CAMERA

Precaution when taking pictures

- Do not use the camera in a place where the camera may come in contact with rain or water because the camera is not weather-resistance. Should the camera get wet from rain or splashing water, wipe it off immediately with a dry soft cloth.
- Do not drop the camera or allow it to hit a solid object. If the camera suffers a severe shock or impact, take it to a Pentax service center for inspection.
- Be careful not to subject the camera to strong vibrations, shock or pressure. Use a cushion to protect the camera when carrying it in a motorcycle, car, boat, etc.
- Condensation on the interior or the exterior of the camera may be extremely harmful to the camera mechanism as it may cause rust and/or corrosion. Furthermore, if the camera is taken from warm temperature to a sub-freezing one or vice versa, the formation of icelets may cause the damage. In such a case, put the camera into a case or plastic bag so that any changes in temperature will be as gradual as possible. After temperature difference is minimized, take it out of the bag.

- Do not apply force to the zoom lens; do not place the camera with lens facing downward.
- Dirt, mud, sand, moisture, toxic gas, water, salt water, etc., penetrating the inside of the camera may cause damage or render it inoperable. Damage of any kind will not be prepared under the terms of the warranty and charges may be assessed. Therefore, handle the camera with great care.

Precaution for taking care

- Use a blower and lens brush to remove dust accumulated on the lens or the viewfinder window.
- Never use solvents such as paint thinner, alcohol or benzine to clean the camera. To clean the external camera surfaces, - but not glass surfaces; using a dry or silicone-treated cloth is recommended.
- The electric circuitry inside the camera contains high voltage working parts. Never attempt to disassemble the camera.
- Never attempt to manually open the lens cover; it will automatically open and close as the main switch is turned on and off.

Precaution for storage

- Avoid leaving the camera for extended periods in places where the temperature and humidity are high such as in a car.
- Do not store the camera in a closet with mothballs or in a case where chemicals are handled. Store it in a place with good air circulation to prevent fungus growth.

Other precautions

- The temperature range at which this camera functions properly is 50°C to -10°C (122°F to 14°F).
- Regular size color prints may cut off what appears on the extreme edges of the film frame. Compose your picture with a margin of safety at the edge.
- To maintain optimum performance, it is recommended that the camera be inspected every one or two years. If the camera has not been used for an extended period, or is being prepared for an important photographic session, it is recommended that you have the camera inspected or test shoot with it.

- Repairs made necessary as a rebuilt of the camera being subjected to any of the conditions warned about in this precautions section, or any other precaution or warning throughout this instruction manual, are not covered under the terms of the warranty and charges may be assessed.

PRECAUTION FOR BATTERY

Precaution for battery

- Misuse of a battery can cause hazards such as leakage, overheating, explosions, etc. The battery should be inserted with the “+” and “-” sides facing correctly.
- Never try to disassemble, short or recharge the battery. Also do not dispose of the battery in a fire, as it may explode.
- Battery performance may be temporarily hindered in low temperature, but will recover in normal temperatures.
- Keep a spare battery on hand for replacement convenience when shooting outdoors or while traveling.
- Keep the battery out of the reach of children.
- When the camera is in a bag, make sure the main switch is off; otherwise, battery power may be wasted if the shutter release button is accidentally pushed.

PRACTICAL SHOOTING GUIDE



Flash photography

Taking a picture in low light situations.	p.17
Minimizing the red-eye effect.	p.26
Taking a portrait picture whose face is cast in shadow.	p.28
Taking a picture of people with sunset scenery in the background.	p.29
Taking a picture of people with night scenery in the background.	p.30



Zooming

Making a subject larger or smaller.	p.11
--	------



Taking portrait pictures in various situations

- Taking a portrait picture whose face is cast in shadow.p.28
- Taking a picture of people with sunset scenery in the background.p.29
- Taking a picture of people with night scenery in the background.p.30
- Putting yourself into a picture.p.31



Landscape photography

- Taking a picture of people with sunset scenery in the background.p.29
- Taking a picture of night scenery.p.30
- Taking a picture of people with night scenery in the background.p.30



Others

- Taking a picture at a distant place from the camera.p.32
- Imprinting date on a picture.p.39

TABLE OF CONTENTS

• Names of working parts	Flaps
• Introduction	Front foldout
• Outline of basic operations	Inside cover
• Precautions for your camera	1
• Precautions for battery	3
• Practical shooting guide	4
• Table of contents	6

PREPARATIONS BEFORE TAKING PHOTOGRAPHS

1. Strap attachment	7
2. Main switch	8
3. Battery check	9
4. How to hold the camera	10
5. Operating the 35-80mm zoom lens	11

TAKING PHOTOGRAPHS

1. Usable film	12
2. Film loading	13
3. Viewfinder displays and shooting ranges	15
4. Lamp indications	16
5. Ordinary photography	17
6. Diopter adjustment	18
7. Taking pictures	19
8. Focus-lock shooting	22
9. Unloading the film	24

TAKING BETTER PHOTOGRAPHS

How to select modes	
/ Red-eye reduction flash mode	26
Daylight-synchro shooting	28
Taking a picture at slow shutter speed	29
Slow-shutter-speed-synch photography	29
Bulb shooting	30
Bulb-synchro photograph	30
Self-timer shooting	31
Using wireless remote control (Option)	32
Taking Panoramic format picture	36
DATE MODEL	39

MAINTENANCE CONSIDERATIONS

Battery exhaustion warning	42
Installing / Replacing the battery	43
Flash effective ranges with films other than ISO100, 200 or 400	45
Troubleshooting	44
Specifications	46
Warranty policy	48
LCD panel	51



STRAP ATTACHMENT

PREPARATIONS BEFORE TAKING PHOTOGRAPHS

For optimum performance you should familiarize yourself with certain fundamentals before taking any photographs.

Fit the strap on the camera as illustrated. Use the illustrated part of the strap to open the battery chamber cover.

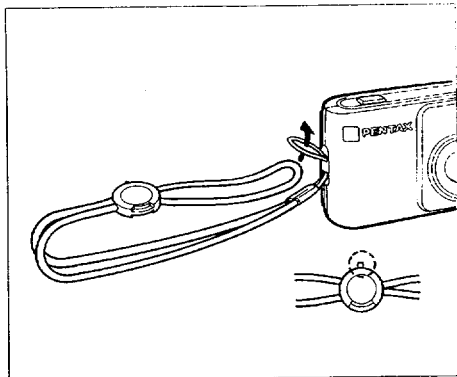



MAIN SWITCH

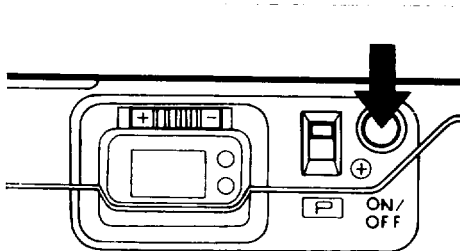

- The lens cover automatically opens and closes when the main switch is turned on and off. Do not attempt to open the lens cover manually.

Main Switch

To switch on, push the main switch button. The lens extends slightly to the wide-angle 35mm setting and the camera is now ready to shoot. To switch off, push the main switch button again. When not in use, ensure that the camera is switched off.

- Use one 3V lithium battery, type CR123A or the equivalent. Do not remove the battery before it is exhausted, since it is used by the date function on the DATE model to keep constant track of time.



BATTERY CHECK

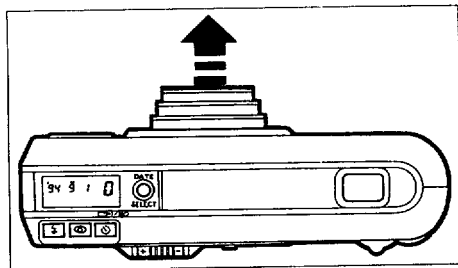

Battery check

After you turn the main switch ON, the lens slightly extends and the lens cover opens. You are now ready to shoot. See page 42 when the battery exhaustion symbol () appears on the LCD panel.

- If the camera is on and left unused for over 3 minutes, the lens automatically retracts and the power switches off to save battery power.
- If the Main Switch is turned on within 60 minutes of auto- power off, the previous setting will automatically return.



HOW TO HOLD THE CAMERA

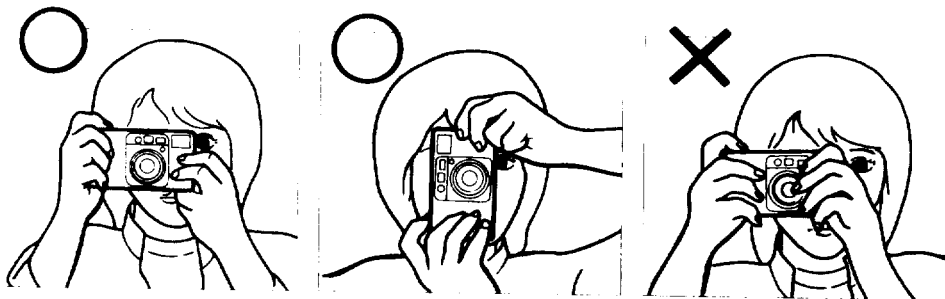

When shooting, hold the camera securely with both hands. Keep the camera as still as possible, and gently depress the shutter release button. (If too much force is applied, the camera is likely to shake, and the picture will be blurred.) Try to brace your elbow against your body, or support yourself and the camera against a stable, stationary object, such as a wall. When using the flash with the camera positioned vertically, hold the camera so that flash is above the lens.

Notes:

- Do not hold the zoom lens because it moves back and forth while in operation.
- Make sure not to obstruct the autofocus window, lens, light sensor window or the built-in flash with your fingers, hair or other object.



OPERATING 35-80mm ZOOM LENS

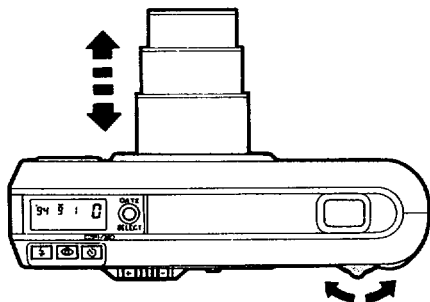

When you move the zooming lever to the right (↗), the lens moves towards the telephoto 80mm setting and frames the subject more closely. When you move the zooming lever to the left (↖), the lens moves towards the wide-angle 35mm setting. When the lens zooms to desired setting, release the zooming lever and depress the shutter release button fully to take pictures.

- If the lens is set at the telephoto 80mm side, the camera is likely to shake, and the picture will be blurred. Using an ISO 400 film is recommended to get less image blur.



USABLE FILM

TAKING PHOTOGRAPHS

After reading this instruction manual you should be familiar with the functions available on the camera, and you're ready to insert the film.

Automatic film speed setting

This camera is designed to use DX-coded films with ISO ratings from 25 to 3200. When any of these films are loaded, the proper film speed is automatically set for the camera.

Notes:

- Use only DX-coded films.
- Non-DX coded films cannot be used. If Non-DX coded film is used, the film speed is automatically set to ISO25.
- Use a high-speed film with an ISO rating of 800 or higher mainly for shooting indoors in dimly-lit conditions.
- A film with ISO400 is recommended to get less image blur and to cover more photographic situations.

2

FILM LOADING (Ensure the power is off before inserting the film.)

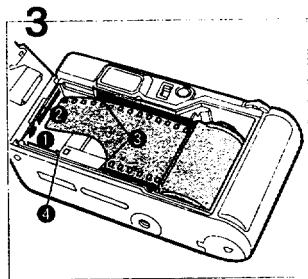
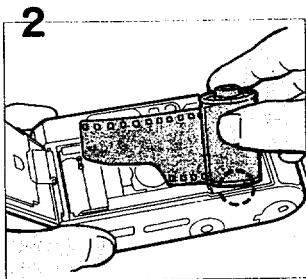
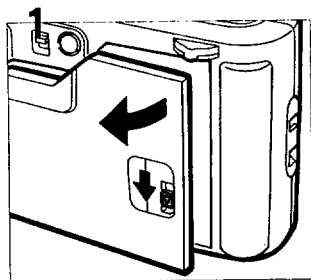

1. Slide the back cover release lever down in the direction of the arrow to open the back cover as illustrated.
2. Place the film cartridge in the film chamber by fitting its flat side on top of the rewind shaft first and then slide the top end into the camera.
3. Pull the film leader out far enough from the cartridge to reach the take-up spool ❶. Align the tip of the film with the film leader end mark ❷.

Note:

- Ensure the film is placed properly between the film guides ❸.
- If there is dirt on the film detector ❶, film cannot be wound properly.

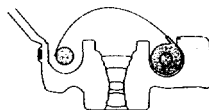

× Slack No!

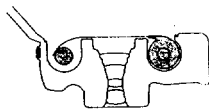

○ Flat Yes!

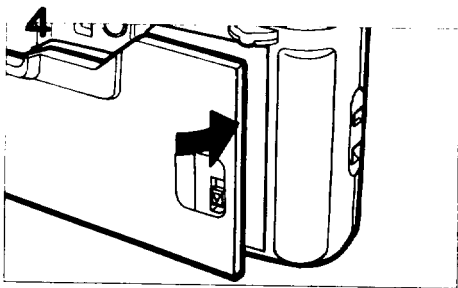

4. After the back cover is closed, the film automatically advance to the first frame.

- Even if no film is loaded, the motor operates for a second or two after the back cover is closed.
- Ensure the film is taut as illustrated on the previous page.
Take up any slack in the film by pushing it back into the cartridge.
- If the end of the film leader is extremely bent, straighten it or cut off the bent portion.

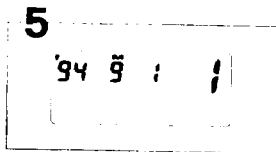

5. When "1" appears in the exposure counter on the LCD panel, the film automatically stops winding. The indicator appears as shown above. If (1) does not appear on the LCD panel, it indicates that the film is not properly loaded. If this occurs, reload the film. If (E) blinks on the LCD panel, it means the film is not properly loaded.

- The exposure counter indication will remain on even if the main switch is turned off.



VIEWFINDER DISPLAY AND SHOOTING RANGES

Ordinary photography

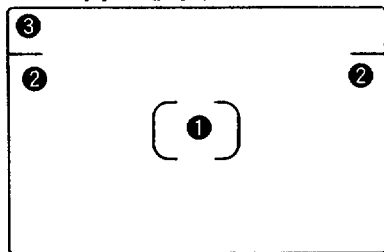

Panoramic format picture

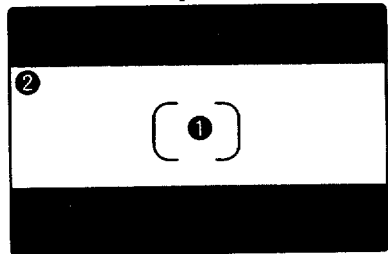

When the Autofocus frame in the viewfinder is not clearly seen, adjust the diopter by moving the diopter adjustment lever. See page 18.

First, switch on power by depressing the main switch button.

Ordinary photography (standard format)

- ① Autofocus frame. Autofocus is referred to as "AF". Focus on the subject with this frame.
- ② Close distance compensation frame
When the camera-to-subject-distance is closer than 1m, compose the scene within this frame.
- ③ Picture area
When taking a normal picture, compose the scene within this frame.

Panoramic format picture

- ① Autofocus frame
- ② Picture area
When taking panoramic format pictures, compose the scene within this frame.

Shooting ranges (effective camera-to-subject distance)

- The ordinary setting and panoramic mode allow a shooting range from ∞ (infinity) to 0.5m(1.6ft).
- Subjects closer than 0.5m(1.6ft) cannot be focused properly.



LAMP INDICATIONS

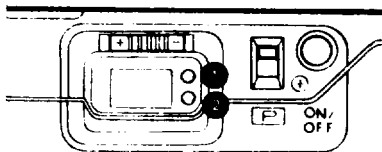

When you depress the shutter release button halfway down, the lamps ● and ● or ● light up or blink.

- Green lamp : When the subject is in focus, it will light up to indicate that you can take the picture; when the subject is out of focus, it will blink, indicating that you cannot take the picture.
- Red lamp : When the flash is ready to discharge, it will light up. When the flash is being charged, it will blink.

Note:

- If the subject is too close or is a hard-to-autofocus subject (see page 21.), the green lamp blinks letting you know that you cannot take a picture.

Focus aid illuminator

In low light situations, and or hard-to-autofocus subjects, the red light is automatically projected to assist the autofocus system when the shutter release button is depressed halfway down.



ORDINARY PHOTOGRAPHY

When the power is switched on by depressing the main switch button, the camera automatically selects the Auto and Single-Frame shooting modes. These modes are used for taking ordinary pictures. The built-in flash will discharge automatically when the subject is poorly illuminated or in a backlight situation.

- When the LCD panel display is different from the one mentioned above (which indicates that other modes are set), switching power OFF and then ON by depressing the main switch button restores the Auto and Single-Frame Shooting modes.



- When the built-in flash automatically discharges, the camera uses a shutter speed of approx. $1/30$ th (38mm) to $1/60$ th sec. (80mm) when ISO400 film is used.

6

DIOPTER ADJUSTMENT

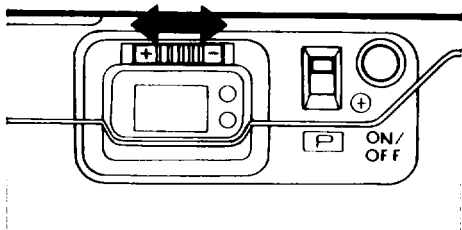

Aim the camera at a bright object. While looking through the viewfinder, move the diopter adjustment lever to the right or left until the autofocus frame appears in the sharpest focus.



TAKING PICTURES [Shooting distance: 0.5m (1.6ft) - ∞ (infinity)]

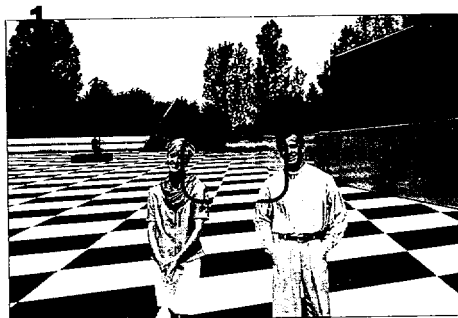

1. Composing the scene

After zooming the lens and composing your scene, focus on the subject with the autofocus frame in the center of the viewfinder.

- If the autofocus window is dirty, the autofocus may not function properly.

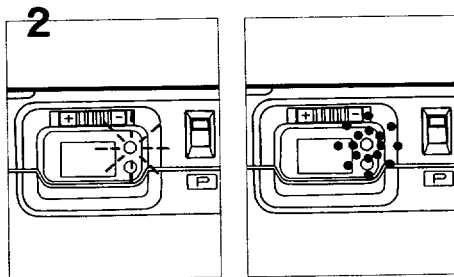

2. Checking the lamp indication

Depress the shutter release button halfway down. When the subject is in focus, the green lamp will light up. The green lamp blinks when the camera is not able to obtain proper focus for one of the following reasons.

- ① The subject is too close. Extend the camera-to-subject- distance until the green lamp is lit continuously.
- ② The subject is difficult to autofocus. See page 21.

3

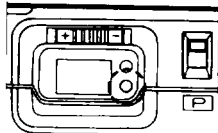

3. Shooting

Depress the shutter release button fully, and the shutter will be released. Then, the film automatically advances to the next frame.

Notes:

- When the shutter is released, the self-timer lamp momentarily lights up to indicate that a picture has been taken.
- If you wish to focus on another subject, lift your finger from the shutter release button and depress the shutter release button halfway down again.
- The shutter cannot be released while the lens is zooming.

Automatic Flash Emission

When taking pictures in low light or in a backlight situation, the flash will automatically discharge. When the shutter release button is depressed halfway down in low light, the red lamp will light up, indicating the flash is ready to discharge. If the built-in flash is being charged and the shutter cannot be released. Therefore, ensure that red lamp is lit continuously before taking pictures.

Red-eye

Shooting portraits with the flash may result in "red-eye", the red dot in your subject's eye. This camera includes a red-eye reduction flash function, which reduces the red-eye phenomenon by discharging pre-flash. See page 26 and 49 for details.

Flash effective ranges (Nega-color film used)

Lens	ISO	Flash effective ranges (Nega-color film used)		
		100	200	400
35mm (◆◆◆)		0.5~4.5m (1.6-14.7ft)	0.5~6.3m (1.6-20.7ft)	0.5~9.0m (1.6-29.5ft)
		0.5~2.2m (1.6-7.2ft)	0.5~3.1m (1.6-10.2ft)	0.5~4.3m (1.6-14.1ft)

HARD-TO-AUTOFOCUS SUBJECTS

The autofocus system is highly precise, but not perfect. Some subjects may not focus as you wish. In such a case, use the focus-lock technique on a subject near the actual one and equidistant from the lens. (see page 22.) The subjects which may fool the autofocus system include:

- a) Extremely low-contrast subjects such as a white wall or blue sky in the autofocus frame.
- b) Subjects which don't reflect much light in the autofocus frame.
- c) Subjects which are moving too fast.
- d) Subjects with horizontal lines or with finely complex or detailed patterns in the autofocus frame.
- e) Multiple subject in foreground of the autofocus frame.
- f) Subjects positioned against reflected light or strong backlight or with extremely bright background.

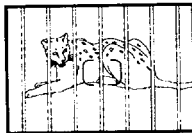
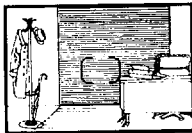
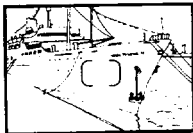



FOCUS-LOCK SHOOTING

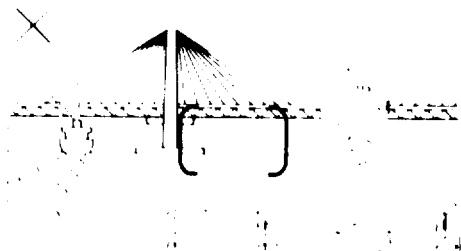

If you shoot without positioning the autofocus frame (U) on the main subject as illustrated above, only the background will be in focus. When the main subject is off the autofocus frame in the center of the viewfinder, use the focus lock technique. (Focus lock is the function to lock focus.)

1

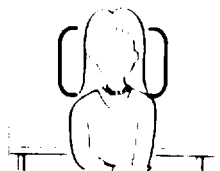

2

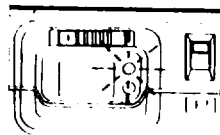

- 1 Focus on the subject as you wish with the autofocus frames (U).
- 2 When the shutter release button is depressed halfway down, the green lamp on the right-hand side of the viewfinder lights up and the exposure and focus are temporarily locked.

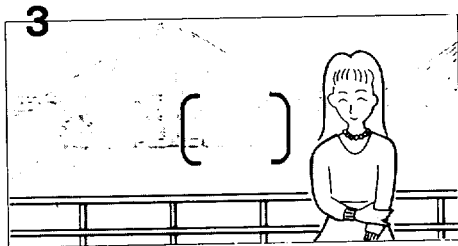

3 While depressing the shutter release button half-way down, re-aim the camera or recompose the picture, then release the shutter.

Note:

- You can release focus lock simply by lifting your finger from the shutter release button.



UNLOADING FILM (Remove the film from the camera in the shade or use your body to shade the camera.)

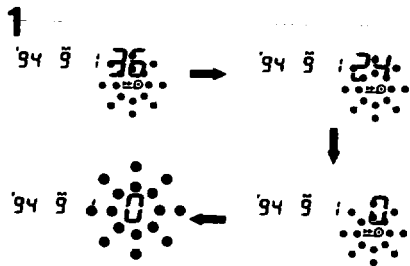

1 Rewinding the film

After you have exposed the last frame of the roll, the film starts rewinding automatically. Then, the motor stops, and (0) blinks as shown to indicate that the film has been rewound.

- A 24-exposure roll of film takes about 20 seconds to be rewound.
- During rewinding, the exposure counter counts frame numbers in reverse.
- The entire roll of film including the film leader is always rewound into the cartridge to prevent any part of the film being exposed to light.

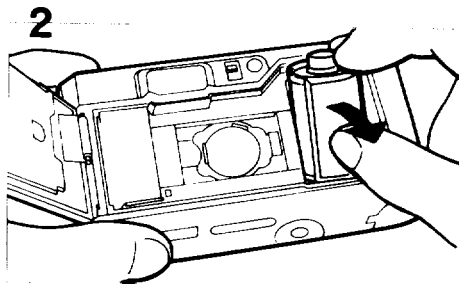

2 Unloading the film

To unload the film, open the back cover, and remove the cartridge from the chamber by pulling the top out first with your finger.

Notes:

- The shutter may be released a frame or two even after the specified number of frames have been used up as indicated by the number of shots shown on the film canister. If this occurs, these extra frames may be lost in the processing.
- Never open the back cover until the whole film roll is rewound.

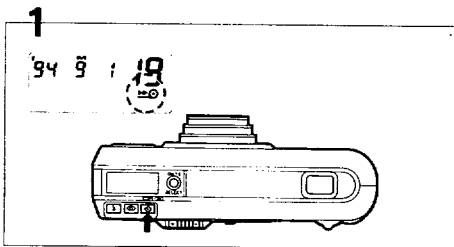

Rewinding a film in mid-roll

If you wish to unload a film before exposing all the frames, follow the procedures described below.

- 1 Turn the main switch ON and hold down the drive button more than 3 seconds. () appears on the LCD panel, indicating that the mid-roll film rewinding mode has been set.

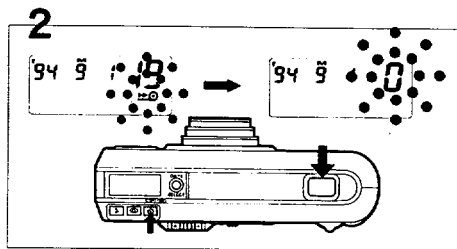

- 2 While holding down the drive button, depress the shutter release button. Film rewinding starts. When the roll of film is rewound to its end, the motor stops and () blinks, indicating that the back cover may be opened safely.

HOW TO SELECT MODES / RED-EYE REDUCTION FLASH MODE

TAKING BETTER PHOTOGRAPHS

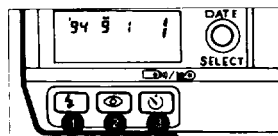

To set various exposure modes, depress the mode button ●.

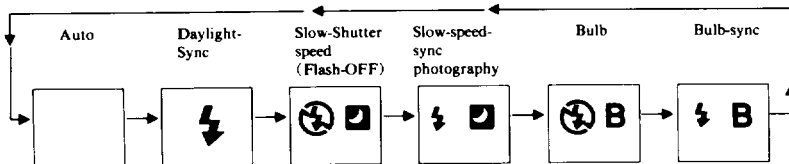

Turn the main switch ON.

- To set various required modes, depress the button ● and/or ●.
- For normal use, set the Auto and Single-Frame modes as shown in above. When the power is switched on, the Auto and Single-Frame Shooting modes are automatically set.
- When the button ● is depressed after the shutter is released in any exposure mode, the Auto mode will automatically return.

Red-Eye Reduction Flash Function

To reduce the red-eye phenomenon in the picture, depress the red-eye reduction button (●) ●. With this mode, the flash discharges two consecutive times, reducing the appearance of the red-eye effect. To cancel this mode, depress the red-eye reduction button again.

To set various shooting modes, depress the drive button ③.

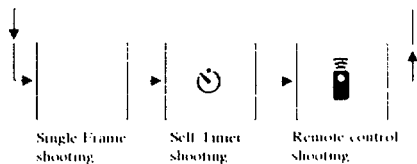

- When the button ③ is depressed after the shutter is released in any shooting mode, Single Frame will automatically return.
- Holding down the drive button ③ for more than three seconds sets the mid-roll rewinding mode. See page 25.

DAYLIGHT-SYNCHRO SHOOTING

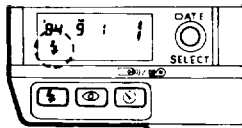

Depress the mode button until the (⚡) symbol appears on the LCD panel. The flash will discharge in both dark and bright conditions. When a portrait is taken with the subject in a backlight situation, the front of the subject may be cast in shadow. In such a case, use Daylight-Synchro Shooting mode (Flash ON mode) within the flash effective range to take pictures. This will ensure that a picture is well exposed without any shadow. In this mode, the flash will always discharge.

Notes:

- Make sure that the red lamp on the right-hand side of the viewfinder is lit when the shutter release button is depressed halfway down before shooting.
- Make sure you're within the flash effective range even when you use the built-in flash as a fill-in flash in daylight.



without Daylight-aync



with Daylight-sync

TAKING PICTURE AT SLOW SHUTTER SPEED

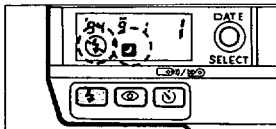

Slow Shutter Speed (Flash-OFF)

Depress the mode button until the () symbol appears on the LCD panel. In

this mode, the flash does not discharge, and a picture is taken at a slow shutter speed up to approx. 2 seconds. Use it in theaters and museums. Furthermore, this mode is also useful for a natural existing light in low ambient light photography.

Note:

- When shooting in low light, the shutter speed gets slower, and camera shake is likely to blur your picture. Use of a tripod is recommended.

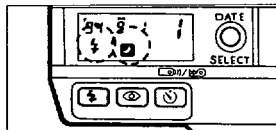

Slow-Speed-Synchro (Flash-ON)

Depress the Mode Button to set the Slow-Speed-Synchro mode until the

() symbol appears on the LCD panel. It is possible to photograph subjects and background in a balanced way by using the built-in flash to properly expose the foreground subject and a Slow-Shutter-Speed to expose the low light background.



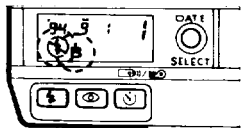

BULB, BULB-SYNCHRO SHOOTING

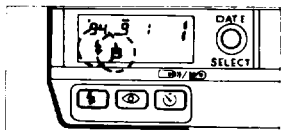

Bulb mode (B)
Depress the Mode Button until ( B) symbol appears on the LCD panel. The shutter remains open

up to 5 minutes as long as the shutter release button is held down. This mode is useful for long exposures required for shooting fireworks and night scenes, for instance. When using this mode, the camera should be mounted on a tripod so that the camera will be steady.



Bulb-synchro mode ( B)
Depress the mode button until ( B) symbol appears on the LCD panel, this lets

you use the flash in addition to the Bulb mode, so you can take a portrait photograph with a night scene in the background, for example.



Bulb mode, approx.3-sec.(ISO100)

SELF-TIMER PHOTOGRAPHY

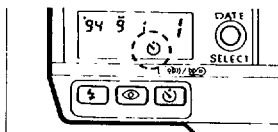

Self-Timer

Use the self-timer if you wish to get in the picture. Use of a tripod is recommended.

Depress the drive

button until the () symbol appears on the LCD panel.

Notes on the Self-Timer shooting

- Keep in mind that when starting the self-timer while standing in front of the camera, the camera may not focus the subject.
- To cancel the self-timer at any time after it's been activated, depress any one of the buttons next to the LCD panel. In this instance, the power will not be turned off.
- When you want to use the flash with the self-timer, make sure that the red lamp is charged (The red lamp lights up) before operating the Self-Timer.
- When the Bulb mode is used in combination with the self-timer, a shutter speed of approx. 1/2 sec. is automatically selected.

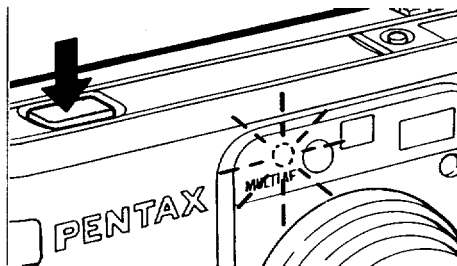

Focus on the subjects first by depressing the shutter release button halfway down, and then depress the shutter release button fully. The shutter will be released in about 10 seconds. When the self-timer is working, the self-timer symbol () blinks on the LCD panel, and the self-timer lamp lights up. The lamp starts blinking 3 seconds before the shutter is released, letting you know when to smile.

USING THE WIRELESS REMOTE CONTROL (OPTION)

If you have purchased the optional wireless remote control, read this section. The wireless remote control allows you to trip the shutter at a distance. The shutter will be released in 3 seconds if the remote control's button is depressed.

- Use a tripod when shooting with the wireless remote control.
- When the remote control is used to take pictures, the Single-Frame mode can be used in combination with any of the exposure modes. The Self-Timer shooting mode cannot be used in this case.
- Use the remote control to take pictures in the Bulb mode to avoid camera shake. While the remote control's shutter release button is held down, the shutter remains open up to a max. of 5 minutes.

Remote Control Shooting mode

Depress the camera's drive button each time until () symbol appears on the LCD panel.

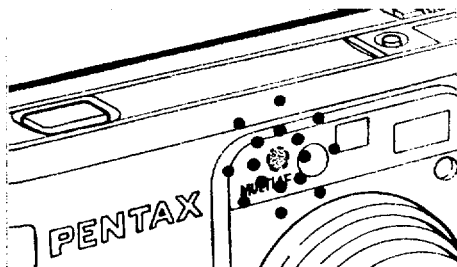
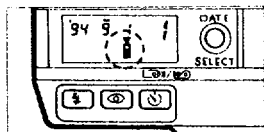

Blinking Lamp

When the Remote Control Shooting mode is set on the camera, the self-timer lamp on the front of the camera blinks slowly, indicating that you can take pictures with the aid of a remote control.

- When the camera is set in the Remote Control Shooting mode and left unused for 5 minutes, the lens automatically retracts itself to save power and Single-frame will be set.

Name of parts

Shutter release button

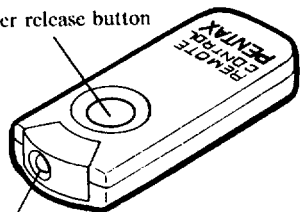

Remote Control Transmitter

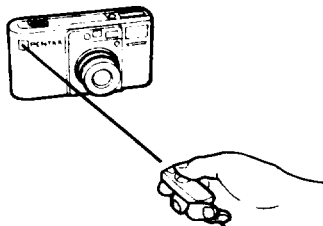

- Focus cannot be locked when the remote control is in use. The subject framed in the AF frame will be in focus when the remote control's shutter release button is depressed.

Taking Pictures

Compose the scene and frame the subject with the AF frame. Aim the remote control transmitter towards the remote control receiver on the camera, and then depress the remote control's shutter release button fully to release the shutter.

- The self-timer lamp blinks rapidly for 3 seconds and then the shutter is released.
- If the shutter is released by the camera's release button, pictures will be taken in the ordinary shooting mode.

Operating Distance of the Wireless Remote Control from the camera's front: within approx. 5m (16.5ft) straight in front of the camera

- The remote control may not work in a backlight situations. In this case, use the camera's shutter release button in the Self-Timer mode to take pictures.
- The remote control does not work while the built-in flash is being charged.

Battery life on the Remote Control

About 30,000 commands can be issued using the Remote Control with a battery installed. If the battery is exhausted, please have it replaced at your local Pentax Service center (there is a charge for this service).

TAKING PANORAMIC FORMAT PICTURE

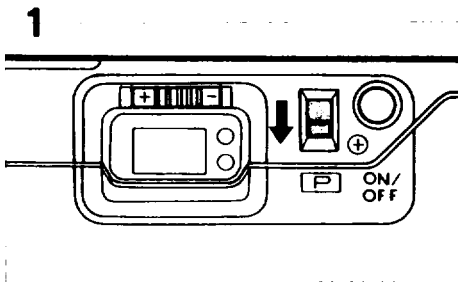

You can switch between the panoramic format and standard picture taking mode in the middle of the roll by moving the panorama mode sector lever. The panorama format picture allows horizontal positioned dynamic picture to be taken (13x36mm on film).

1 Switching to the panoramic format picture

Move the panorama mode selector lever to (P) to select the panoramic format mode.

- When the format is switched to panorama, the viewfinder switches to the horizontal panoramic format frame.

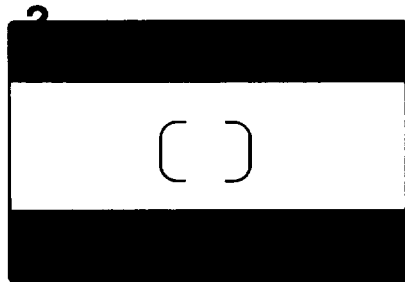

2 Taking a panoramic format picture

Compose the scene within the panoramic format frame, and then fully depress the shutter release button to take a panoramic format.

- When the camera-to-subject distance is less than 1m, panoramic format photography is not recommended due to a substantial difference between what you see through the viewfinder versus the image you will obtain the actual picture taking area.



The mark “—” indicates the position where the date and time are imprinted.

The DATE MODEL allows you to record DATE information in the panoramic mode in a similar manner to the standard picture taking mode. See “DATE MODEL” on page 39 for details. The dating unit automatically switches the DATE position between the standard and panorama according to the format mode selected.

NOTES ON THE DEVELOPMENT OF PANORAMIC FORMAT PICTURES

- When developing the film, if you have taken only panoramic format pictures on the entire roll of film, tell the clerk at the processing lab to develop the film with only the panoramic format. If there are both panoramic and standard format photographs on the film, ask the clerk to develop the film with both standard and panoramic format.

- The development of panoramic format pictures is a more time consuming and expensive process than that of standard pictures.
- Panoramic format processing facilities differ depending on the area and requirement. Your local film processor or camera dealers will advise you on all the options available to you.
- With panoramic format pictures, only the middle area of the frame is exposed. The number of exposures available in the panoramic format is equivalent to that of the standard photo size.



- When the panoramic format picture is printed with a standard size format, the black cropped areas will appear on the top and bottom of the picture.

DATE MODEL

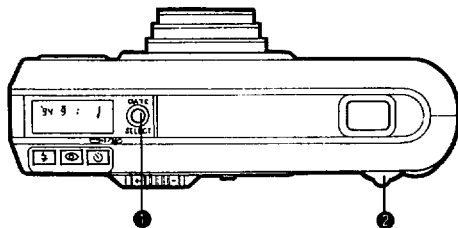

If you purchase the DATE model, read this section. The DATE model records dates up to the year 2030.

- ① **DATE** Select button
- ② Zooming lever Adjust lever

Switching the Mode

At each press the date button ① with your finger, the mode on the LCD panel switches as shown in the chart.

Notes:

- “-----” indicates no data will be imprinted.
- “M” on the LCD panel indicates “Month”.
- The data cannot be corrected without the power ON.

Numerical Indication

Year = 94-30 (1994-2030)
Month = 1-12
Day = 1-31
Time = 0-23
Minute = 00-59

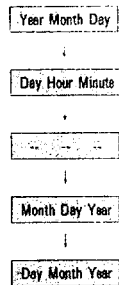

Correcting the date

Switch the power on by depressing the main switch button.

1. Keep depressing the ● Date button for 3 seconds, the “Year” digits and () will blink.
 2. Each time the DATE button ● is depressed, the blinking digits change in the following manner: Year-Month-Day-Time- Minute. Stop depressing the button when desired digits appear.
 3. Move the Zooming lever to the right or left, when you wish to change the blinking digits. The digits increase by one each time the lever moves to the right and the digits decrease by one each time the lever moves to the left. Holding the zooming lever for about one second will change the digits continuously.
 4. After the data has been adjusted, depress the date button ● each time until blinking stops.
- The blinking “minutes digits” allow precise fine tuning of the internal clock to the beginning of a specified minutes. To do so, depress the DATE button each time until the minutes digits start blinking, and then depress the DATE button in sync with a time signal.
 - If you release the shutter while the blinking data is being corrected, the data cannot be imprinted.
 - The date is initialized to 94/1/1 and (----) bar marks appear after replacing or removing the battery.
 - For correction just after replacing the battery, the year digits and the zooming lever indication will blink if the DATE button is depressed, unnecessary to depress it for 3 seconds. Follow the steps listed above to reset the time and date.

OPERATIONAL PRECAUTIONS

The data on the LCD panel is imprinted on each frame you expose.



- “Year-Month-Day” and “Day-Hour-Minute” cannot be imprinted at the same time.
- The dating unit automatically switches the imprint mode between the standard format and the panorama according to the format mode is selected by moving the panorama mode selector lever.
- If there is a white or yellow object in the corner of the picture where the data is imprinted, the data may be difficult to read. When composing your photographs, try to avoid brightly-colored subjects in that corner.
- The data may not be imprinted correctly if the pictures are taken more than the specified number of frames indicated on the film canister.

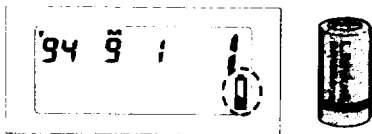

* The date in the picture above is simulated.

BATTERY EXHAUSTION WARNING



When the battery is nearly exhausted, the battery symbol () appears on the LCD panel to warn you. Replace the battery as soon as possible. When () starts blinking, no operations can be performed.

Battery life (using 24-exposure film rolls):

Approx. 15 rolls using flash 50% of the time (using the CR123A battery and under Pentax testing conditions).

- Switch the power off before replacing the battery.
- The CR123A battery was used under Pentax testing conditions. Actual battery life performance may vary drastically depending on usage of Autofocus, Power zoom, Flash, and external conditions such as temperature and freshness of the battery.

Notes on replacing the battery:

- The battery is used by both the camera body and the data back function on the DATA model to keep constant track of time. After the battery is replaced, correct the time and date. See page 40.
- The no. of exposed frames are memorized and unchanged even if the battery is replaced.

INSTALLING/REPLACING BATTERY Use one 3V lithium battery (CR-123A or the equivalent

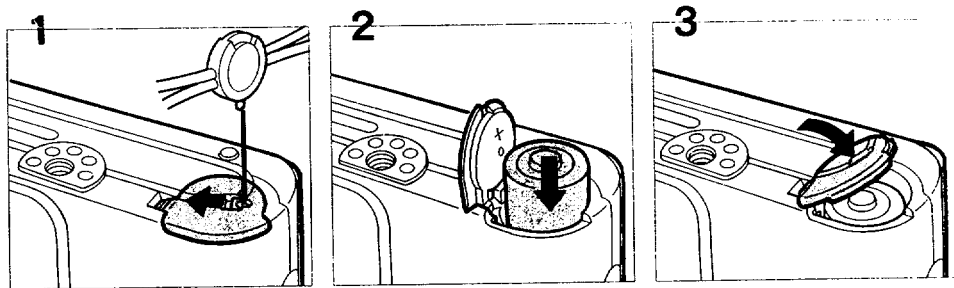

Ensure that the power is off before replacing the battery.

1. Open the battery chamber cover by pulling the cover lock in the direction of the arrow with the strap clamp's protrusion.
2. Insert one lithium battery with the plus/minus (+/-) sides matching the indications in the battery compartment.

3. Close the battery chamber cover. Ensure that the cover is locked with a click.

- If the battery is correctly loaded, the zoom lens moves slightly.
- On the DATE MODEL, the date is initialized to 94/1/1 when the battery chamber cover is opened. See page 40 for correcting the data.

TROUBLESHOOTING

What appears troublesome may be easily remedied. Here are some problems that may occur and their remedies.

Symptoms	Causes and Remedies
1. The shutter cannot be released.	<ul style="list-style-type: none">• Is the main switch turned off? If so, turn it on. See page 8.• Is the battery exhausted? Replace it or insert new battery if it is exhausted. See page 42.• Is () blinking on the LCD panel? If so, the film has been used up. Insert a new roll. See page 24.
2. My printed pictures don't look very clear.	<ul style="list-style-type: none">• Did you position the autofocus frame on your subjects? See page 19.• Did you obstruct the autofocus window with your finger, hair or other object when you depressed the shutter release button? See page 10.• Is the autofocus window dirty? Wipe it off. See page 19.
3. Zoom lens retracted automatically (the power is turned off automatically).	<ul style="list-style-type: none">• Did you leave the camera unused for over 3 minutes after the main switch was turned on? The power is automatically switched off if the camera is left unused for over 3 minutes. See page 9.• When the camera is on and left unused for more than 5 minutes in the Remote Control shooting mode, the camera automatically switches itself off to save battery power. Push the main switch again to turn it on. See page 33.

Symptoms	Causes and Remedies
4. The remote control does not operate.	<ul style="list-style-type: none"> The operable distance of the remote control is approx. 5m from the front. See page 35. The Remote Control may not operate in a backlit situation. See page 35. The flash is being charged. Wait until it fully charges. See page 35. Is the battery for the remote control exhausted? See page 35.
5. The flash discharges, though it is not dark.	<ul style="list-style-type: none"> The flash discharges automatically in a backlit situation. See page 20. Daylight-syncro mode has been set. See page 28.
6. The (H) or (U) mark is displayed on the LCD panel.	<ul style="list-style-type: none"> If either mark disappears when the zoom lever is moved, the camera is ready for use. The camera may be defective if either mark appears often.



Flash effective ranges with films other than ISO 100, 200 or 400 (Nega-color film used)

Lens \ ISO	25	50	800	1600	3200
35mm (◆◆◆)	0.5-2.3m 1.6-7.5ft	0.5- 3.2m 1.6-10.5ft	0.5-12.7m 1.6-41.7ft	0.5-18.0m 1.6-59.0ft	0.6 * -25.4m 2.0 * -83.3ft
80mm (◆)	0.5-1.1m 1.6-3.6ft	0.5-1.5m 1.6-4.9ft	0.5- 6.1m 1.6-20.0ft	0.5- 8.7m 1.6-28.5ft	0.5-12.2m 1.6-40.0ft

* With high speed film, overexposure may occur at close range due to the film's high speed.

SPECIFICATIONS

Type:	35mm fully automatic leaf-shutter camera with built-in zoom lens and auto flash.
Film:	Auto film speed setting with 35mm perforated DX-coded film with ISO rating from 25 to 3200 (1EV step). Non-DX coded films are automatically set to ISO25.
Format:	24x36mm (13x36mm in panoramic format)
Film loading:	Auto film loading. Closing the back cover will automatically wind the film to first exposure.
Film winding:	Auto film-winding: single-frame advance mode.
Film rewinding:	Auto start at the end of roll. Auto stop upon completion of rewinding. Rewinding time: approx 20 sec. with 24-exposure film. Rewinding in mid-roll provided.
Frame number:	Automatic readout of successive frame numbers in ascending order when shooting, and descending order when rewinding.
Lens:	Pentax power zoom 35-80mm f/4.1-8.7 7 elements in 6 groups. Angle of view: 63° - 30.5°
Focusing system:	Pentax phase-matching passive multi (5-points) autofocus system. Focus lock is provided. Range: 0.5m/1.6ft - infinity/ Maximum magnification approx. 1 : 5.4X. Focus aid illuminator is automatically emitted in low light and/or hard-to-autofocus subject.
Zooming:	Electronic zoom
Shutter:	Programmed AE electronic shutter with speed approx. 1/400 to 2 sec. Bulb: 1/2sec. - 5min. Electromagnetic release.
Self-timer:	Electronic red lamp indication. Approx. 10sec. delay with LED indication. Cancellation after activation is possible.
Viewfinder:	Actual image zoom viewfinder. 83% field-of-view ratio. Magnification: 0.42X (35mm WIDE) - 0.85X (80mm TELE). Diopter -3 to +1D. AF frame. Picture frame. Close distance compensation frame for standard format. Panoramic format picture area. Green lamp lighting: in-focus signal. Green lamp blinking: when subject is too close and/or hard-to-autofocus subject. Red lamp lighting: Flash-ready status. Red lamp blinking: Flash being charged.
Exposure control:	Programmed auto-exposure control with two divided light receiving sensor. Range: EV9.5-EV17 at 35mm WIDE. EV12-EV17.5 at 80mm TELE in Auto or Daylight-Synchro mode (ISO 100). EV3.5-EV17 at 35mm WIDE, EV5.5-EV17.5 at 80mm TELE in Slow-Shutter-Speed mode. Automatic exposure compensation in a backlit situation.

Exposure-meter switch:	The exposure meter is turned on by half depression of the shutter release button.
Flash:	Built-in flash with red-eye reduction mode, Automatic flash emission in low-luminance or a backlit situation, Flash ON = Day-light-Synchro/Slow-Shutter-Speed Synchro (up to 2 sec.), Flash-OFF = Flash override, Bulb-Synchro = 1/2 sec.-5min.
Flash effective range:	0.5-4.5m (35mm WIDE), 0.5-2.2m (80mm TELE) (ISO100 film used)
Flash recycling time:	Approx. 5 sec. under Pentax testing conditions
Remote control:	Infrared wireless remote control, 3-second delay shutter release, Effective range: Closer than 5m from the front when projected from the camera's front.
Power source for Remote Control:	One lithium battery CR1620 (replaced by the Pentax Service facility)
Size & weight for Remote Control:	22.0(W)x50.0(L)x9.5(D)mm (0.9" x2.0" x0.4"), 9g(0.3oz.) including battery.
Battery life:	Approx. 15 rolls of 24 exposure film when 50% of shooting uses flash (under Pentax testing conditions)
Battery exhaustion warning:	() appears on the LCD panel, Shutter is locked when () is blinking.
Date mechanism:	Crystal quartz controlled; LCD with digital clock, auto calender up to 2030. Possible to imprint both standard and panoramic format frames.
Imprinting mode:	"Year, Month and Day", "Day, Hour and Minutes", "---- blank", "Month, Day and Year" or "Day, Month and Year".
Size & Weight:	124.0(W)x65.0(H)x33.5(D)mm (4.9" x2.6" x1.3") 210g (7.4oz) without battery.
Date model:	ditto

SPECIFICATIONS ARE SUBJECT TO CHANGE AT ANY TIME WITHOUT NOTIFICATION OR ANY OBLIGATION ON THE PART OF THE MANUFACTURE.

WARRANTY POLICY

All Pentax cameras purchased through authorized bona fide photographic distribution channels are guaranteed against defects of material or workmanship for a period of twelve months from date of purchase. Service will be rendered, and defective parts will be replaced without cost to you within that period, provided the equipment does not show evidence of impact, sand or liquid damage, mishandling, tampering, battery or chemical corrosion, operation contrary to operating instructions, or modification by an unauthorized repair shop. The manufacturer or its authorized representatives shall not be liable for any repair or alterations except those made with its written consent and shall not be liable for damages from delay or loss of use or from other indirect or consequential damages of any kind, whether caused by defective material or workmanship or otherwise; and it is expressly agreed that the liability of the manufacturer or its representative under all guarantees or warranties, whether expressed or implied, is strictly limited to the replacement of parts as hereinbefore provided. No refunds will be made on repairs performed by non-authorized Pentax service facilities.

Procedures During 12-month Warranty Period

Any Pentax which provides defective during the 12-month warranty period should be returned to the dealer from whom you purchased the equipment or to the manufacturer. If there is no representative of the manufacturer in your country, send the equipment to the manufacturer, with postage prepaid. In this case, it will take a considerable length of time before the equipment can be returned to you owing to the complicated customs procedures required. If the equipment is covered by warranty, repairs will be made and parts replaced free of charge, and the equipment will be returned to you upon completion of servicing. If the equipment is not covered by warranty, regular charges of the manufacturer or its representatives will apply. Shipping charges are to be borne by the owner. If your Pentax was purchased outside of the country where you wish to have it serviced during the warranty period, regular handling and servicing fees may be charged by the manufacturer's representatives in that country. Notwithstanding this, your Pentax returned to the manufacturer will be serviced free of charge according to this procedure and warranty policy.

In any case, however, shipping charges and customs clearance fees are to be borne by the sender. To prove the date of your purchase when required, please keep the receipts or bills covering the purchase of your equipment for at least a year. Before sending your equipment for servicing, please make sure that you are sending it to the manufacturer's authorized representatives or their approved repair shops, unless you are sending it directly to the manufacturer. Always obtain a quotation for the service charge, and only after you accept the quoted service charge, instruct the service station to proceed with the servicing.

This warranty policy does not apply to Pentax products purchased in the U.S.A., UK, or Canada. The local warranty policies available from Pentax distributors in those countries supersede this warranty policy.

LCD (Liquid-crystal display)

- When the LCD is exposed to high temperatures over about 60°C, it may blacken, but when the temperature normalizes, it will return to normal.
- The LCD may also slow down in response to lower temperatures, but this is a normal characteristic of an LCD.

Red-eye phenomenon in flash photography

When a picture is taken using a flash, a subject's eyes may appear red in the print. This phenomenon is caused by the reflection of the electronic flash in the retina. It can be reduced when the surrounding of the subject are brightened, or shooting distance is shortened or by employing the red-eye reduction flash feature.

NAMES OF WORKING PARTS

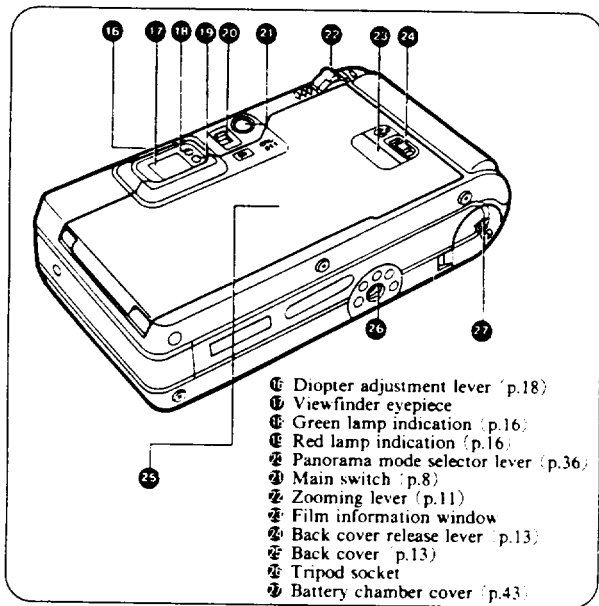

50

FOR YOUR REFERENCE, KEEP
THIS CARD WITH THE CAMERA.

PENTAX IQZ^{zoom} B35

BULB:
CAMERA
STAYS OPEN
FOR AS LONG
AS YOU PRESS
THE SHUTTER
RELEASE
BUTTON

* CAMERA FLASHES AUTOMATICALLY
WHEN NO ICONS APPEAR



☀ DAYLIGHT
FLASH ON



👁 RED-EYE
REDUCTION
ON



🕒 SELF-TIMER
ON
(10 SEC.)

Ⓛ LOW
LIGHT,
FLASH OFF

📷 REMOTE
CONTROL
3 SEC.
DELAY

Ⓛ LOW LIGHT,
FLASH ON

Ⓛ B BULB
FLASH OFF

Ⓛ B BULB
FLASH ON



FOR YOUR REFERENCE, KEEP
THIS CARD WITH THE CAMERA.

LCD PANEL

PENTAX® IQZ^{oom} 835

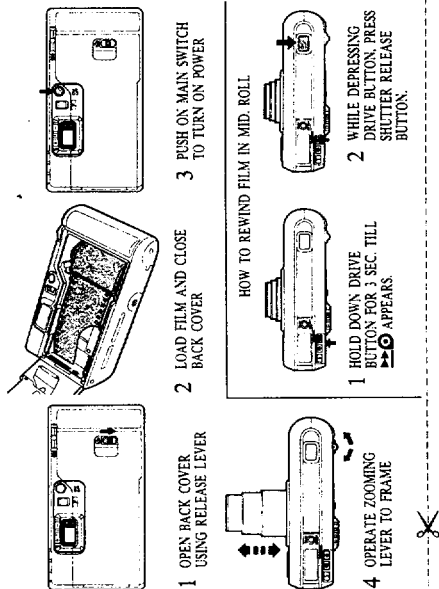

All indications will not actually appear simultaneously as shown.

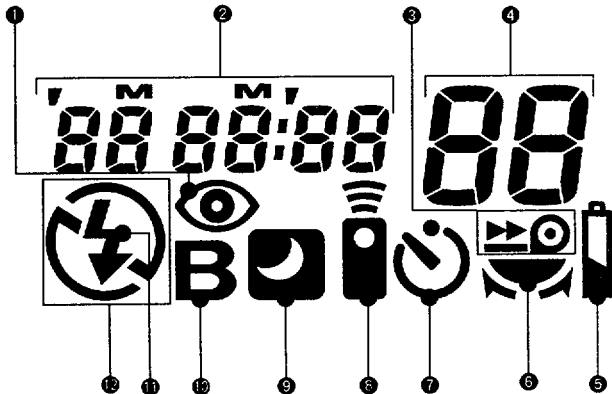

- 1** Red-eye Reduction Flash mode (p.26,49)
- 2** Data Information (p.39)
- 3** Film Rewind mode (p.24)
- 4** Exposure Counter (p.14)
- 5** Battery Exhaustion
- 6** Remote Control shooting mode (p.33)
- 7** Self-Timer (p.31)
- 8** Flash OFF (p.29)
- 9** Bulb (p.30)
- 10** Flash ON (p.28)
- 11** Slow-Shutter-Speed (p.29)
- 12** Zooming Lever (p.11)



Asahi Optical Co., Ltd. 11-1, Nagata-cho 1-chome, Chiyoda-ku, Tokyo 100, JAPAN

Pentax Europe n.v. Weiveldlaan 3-5, 1930 Zaventem, BELGIUM

Pentax Handelsgesellschaft mbH. Julius-Vosseler-Strasse, 104, D-22527 Hamburg, GERMANY

Pentax U.K. Limited. Pentax House, Heron Drive, Langley, Slough SL3 8PN, U.K.

Pentax France S.A. Z.I. Argenteuil 12, rue Ambroise Croizat, 95100 Argenteuil, FRANCE

Pentax Benelux (for Netherlands) Spinveld 25, 4815 HR Breda, NETHERLANDS

(for Belgium & Luxemburg) Weiveldlaan 3-5, 1930 Zaventem, BELGIUM

Pentax (Schweiz) AG. Industriestrasse 2, 8305 Dietlikon, SWITZERLAND

Pentax Scandinavia AB Falhagsleden 57, 75127 Uppsala, SWEDEN

Pentax Corporation 35 Inverness Drive East, Englewood, Colorado 80112, U.S.A.

Pentax Canada Inc. 381 Universal Drive, Mississauga, Ontario L4X 2L5, CANADA