

PENTAX®

IQZ*oom***EZY**

IQZ*oom***EZY**_{DATE}

OPERATING MANUAL



OUTLINE OF BASIC OPERATIONS

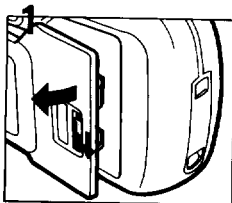

1 Open the back cover (see page 8).

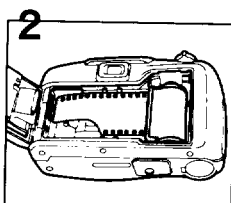

2 Load the film and close the back cover (see page 9).

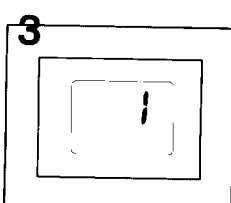

3 The film will automatically advance to the first frame (see page 10).

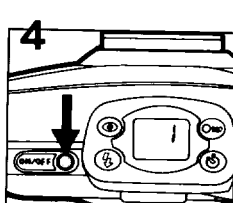

4 Push the main switch button to switch on power (see page 5).

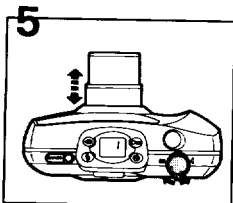

5 Frame your subject and operate the zooming lever to compose the shot (see page 7).



6 Focus on your subject (see page 12).

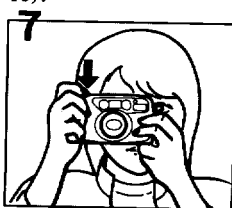

7 Depress the shutter release button. In dark conditions, the flash will discharge automatically (see page 12).

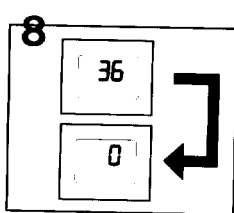







8 When the film is finished, the camera will automatically rewind it (see page 16).

Congratulations on your purchase of the PENTAX IQ Zoom EZY and welcome to the world of Pentax zoom compact photography! Your compact, light weight camera is a great companion to preserve your favorite memories. Its built-in 38-70mm lens gives you the freedom to frame everything from breathtaking landscapes to family portraits, even detailed close-ups. The built-in auto flash helps you capture subjects in dimly-lit places or photograph indoor scenes with clarity and brilliance. Since most of the operation - including film loading, film speed setting, winding/rewinding, focus and exposure control - are automatic, you can take great pictures effortlessly. The DATE model makes it easy to remember the dates when you took pictures.

- Please read this manual carefully before operating the camera to take consistently superior pictures.
- Pay special attention to the cautions and notes in this Operating Manual. Pictures and illustrations used in this manual may differ from the camera's actual appearance.
- Illustrations in this operating manual are the DATE MODEL.

Icon indications used in this manual

Operation direction	
Automatic operation	
Attention	
Lamp lighted	
Lamp blinking	
Correct	
Incorrect	

The name of the camera's working parts are listed on the front and back flaps of this manual. Keep the flaps unfolded for quick reference while reading the manual.

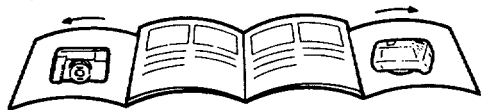

NAMES OF WORKING PARTS

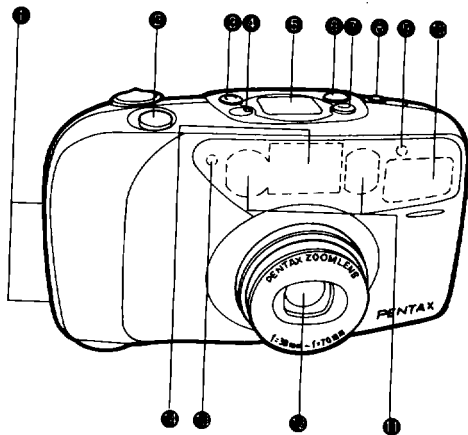

- ① Strap lug (p.4)
- ② Shutter release button (p.12)
- ③ Self-timer button (p.23)
- ④ Auxiliary rewind button (p.17)
- ⑤ LCD panel (p.35)
- ⑥ Mode button (p.18)
- ⑦ Red-eye reduction flash button (p.18)
- ⑧ Main switch
- ⑨ Self-timer lamp (p.23)
- ⑩ Built-in flash
- ⑪ Autofocus window
- ⑫ Lens
- ⑬ Light sensor window
- ⑭ Viewfinder window

TABLE OF CONTENTS

- Names of working partsFlaps
- IntroductionFront foldout
- Outline of basic operationsInside cover
- Table of contents1
- Precautions for your camera2
- Precautions for battery3

PREPARATIONS BEFORE TAKING PHOTOGRAPHS

1. Strap attachment.....4
2. Main switch and Battery check5
3. How to hold the camera6
4. Operating the 38-70mm zoom lens7

TAKING PHOTOGRAPHS

1. Film loading8
2. Viewfinder displays and Lamp indication 11
3. Taking pictures12
4. Focus-lock shooting14
 - Hard-to-autofocus subjects15
5. Unloading film16

TAKING BETTER PHOTOGRAPHS

- How to select modes
 - /Red-eye reduction flash mode18
- Daylight-synchro shooting19
- Taking a picture at a slow shutter speed ...20
- Slow-speed synchro photography20
- Backlight compensation21
- Bulb shooting22
- Bulb-synchro shooting22
- Self-timer photography.....23
- DATE MODEL24

MAINTENANCE CONSIDERATIONS

- Battery exhaustion warning and Loading
 - /Replacing the battery26
- Practical shooting guide27
- Troubleshooting28
- Flash effective range with films other than ISO 100,200, or 40029
- Specifications.....30
- Warranty policy32
- LCD panel35

PRECAUTIONS FOR YOUR CAMERA

Precautions when taking pictures

- Do not use the camera where it may come in contact with rain or water because the camera is not weather resistant. Should the camera get wet from rain or splashing water, wipe it off immediately with a dry soft cloth.
- Do not drop the camera or allow it to hit a solid object. If the camera suffers a severe shock or impact, take it to a Pentax service center for inspection.
- Condensation on the interior or the exterior of the camera may be extremely harmful to the camera mechanism as it may cause rust and/or corrosion. Furthermore, if the camera is taken from warm temperature to a sub-freezing one or vice versa, the formation of icelets may cause damage. In such a case, put the camera into a case or plastic bag so that any changes in temperature will be as gradual as possible. After temperature difference is minimized, the camera may be removed from the bag.

- Do not apply force to the zoom lens; do not place the camera with lens facing downward.
- Dirt, mud, sand, moisture, toxic gas, water, salt water, etc., penetrating the inside of the camera may cause damage or render it inoperable. Damage of any kind will not be repaired under the terms of the warranty and charges may be assessed. Therefore, handle the camera with great care.

Precautions for proper care

- Use a blower and lens brush to remove dust accumulated on the lens or the viewfinder window.
- Never use solvents such as paint thinner, alcohol or benzine to clean the camera. To clean the external camera surfaces, - but not glass surfaces; using a dry or silicone - treated cloth is recommended.
- The electric circuitry inside the camera contains high voltage working parts. Never attempt to disassemble the camera.

PRECAUTIONS FOR BATTERY

Precautions for storage

- Avoid leaving the camera for extended periods in places where temperature and humidity are high such as in a car.
- Do not store the camera in a closet with mothballs or in a case where chemicals are handled. Store it in a place with good air circulation to prevent fungus growth.

Other precautions

- The temperature range at which this camera functions properly is 50°C to -10°C (122°F to 14°F).
- To maintain optimum performance, it is recommended that the camera be inspected every one or two years. If the camera has not been used for an extended period, or is being prepared for an important photographic session, it is recommended that you have the camera inspected or test shoot with it.
- Repairs made necessary due to the camera being subjected to any of the conditions warned about in this precautions section, or any other precaution or warning throughout this operating manual, are not covered under the terms of the warranty and charges may be assessed.

Precautions for battery

- Misuse of a battery can cause hazards such as leakage, overheating, explosions, etc. The battery should be inserted with the "+" and "-" sides facing correctly.
- Never try to disassemble, short or recharge the battery. Also do not dispose of the battery in a fire, as it may explode.
- Battery performance may be temporarily hindered in low temperatures, but will recover in normal temperatures.
- Keep a spare battery on hand for replacement convenience when shooting outdoors or while traveling.
- Keep the battery out of the reach of children.
- When the camera is in a bag, make sure the main switch is off; otherwise, battery power may be wasted if the shutter release button is accidentally pushed.

LCD (Liquid-crystal display)

- When the LCD is exposed to high temperatures over about 60°C, it may blacken, but when the temperature normalizes, it will return to normal.
- The LCD may also slow down in response to lower temperatures, but this is a normal characteristic of an LCD.



STRAP ATTACHMENT

PREPARATIONS BEFORE TAKING PHOTOGRAPHS

For optimum performance you should familiarize yourself with certain fundamentals before taking any photographs.

Fit the strap on the camera as illustrated. Use the illustrated part of the strap for opening the battery chamber cover, adjusting the data on the Date model, or pushing the auxiliary rewind button to rewind a film before exposing all the frames.

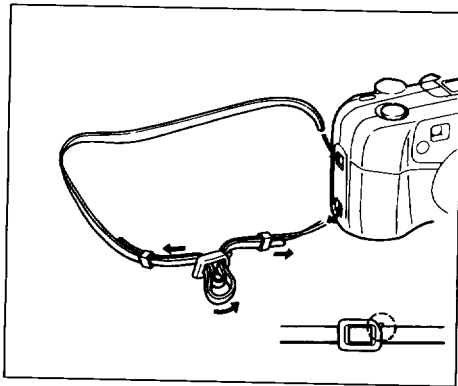



MAIN SWITCH AND BATTERY CHECK

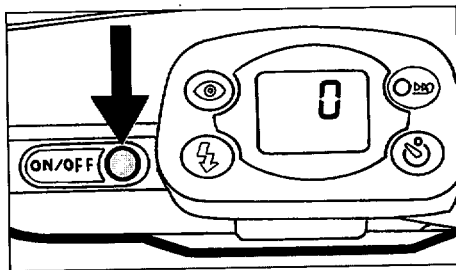

Main Switch

To switch on, push the main switch button. The lens extends slightly to 38mm and the LCD panel is now on. To switch off, push the main switch button again.

- When not in use, ensure that the camera is switched off.
- Use one 3V lithium battery, type CR123A or the equivalent. Do not remove the battery before it is exhausted. If the battery is removed, the data on the DATE MODEL is initialized.
- The lens cover automatically opens and closes when the main switch is turned on and off. Do not attempt to open the lens cover manually.

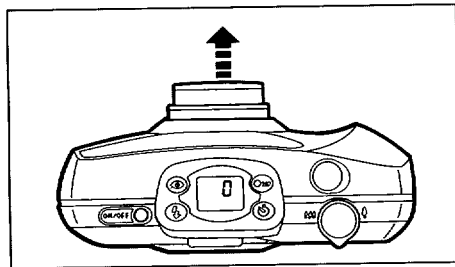

Battery check

After you turn the main switch ON, the lens slightly extends and the lens cover opens. You are now ready to shoot.

- See page 26, when the battery exhaustion symbol () appears on the LCD panel.
- If the camera is on and left unused for over 3 minutes, the lens automatically retracts and the power switches off to save the battery power.
- If the main switch is turned on within 60 minutes of auto-power off, the previous setting will automatically return.

HOW TO HOLD THE CAMERA

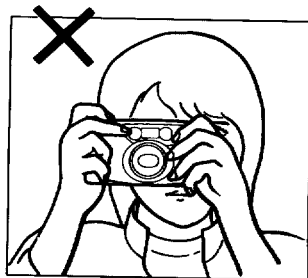
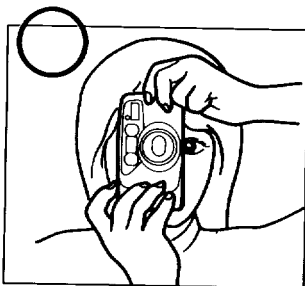
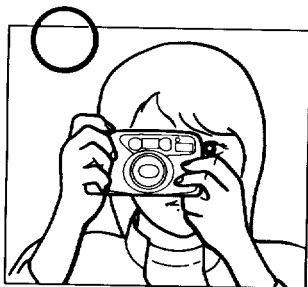

Hold the camera as still as possible and steady it against your face. Depress the shutter release button gently. (If too much force is applied, the camera is likely to shake, and the picture will be blurred.) If possible, brace your body against a stable, stationary object such as a wall. When using the flash with the camera positioned vertically, hold the camera so that the flash is above the lens.

Notes:

- Do not hold the zoom lens because it moves back and forth while in operation.
- Make sure not to obstruct the autofocus window, lens, light sensor window or the built-in flash with your fingers, hair or other object.



OPERATING 38—70mm ZOOM LENS

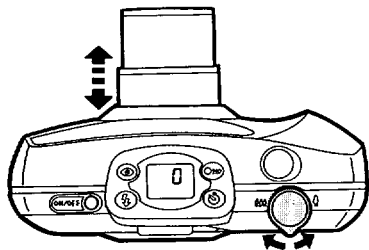
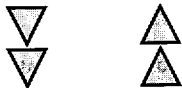

When you move the zooming lever to the right (↔), the lens moves towards the telephoto side. When you move the zooming lever to the left (↔↔↔), the lens moves towards the wide angle side.

Note: The shutter cannot be released while the lens is zooming.



FILM LOADING

TAKING PHOTOGRAPHS

After reading this instruction manual you should be familiar with the functions available on the camera, and you're ready to insert the film.

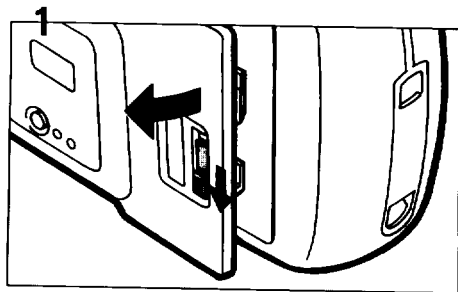

1. Open the back cover as illustrated.
- Ensure the power is off before loading the film.

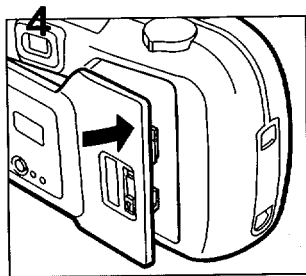
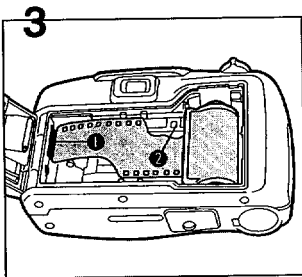
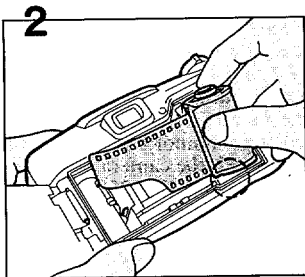

2. Place the film cartridge in the film chamber by fitting its flat side on top of the rewind shaft first and then top end into the camera.
3. Pull the film leader out far enough from the cartridge to reach the take-up spool ①. Align the tip of the film with the film leader end mark ②.
4. Close the back cover. The film automatically advances to the first frame.

Notes:

- Ensure the film is placed properly between the film guides.
- If there is dirt on the film detector ②, film cannot be wound properly.
- Ensure the film is taut as illustrated on the illustration to the left. Take up any slack in the film by pushing it back into the cartridge.
- If the end of the film leader is extremely bent, straighten it or cut off the bent portion.





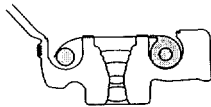

×Slack No !

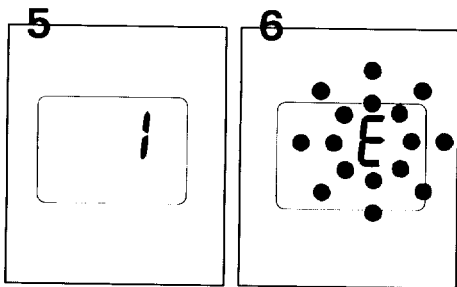

○Flat Yes !



5. When [] appears in the exposure counter on the LCD panel, the film automatically stops winding. Ensure that [] appears on the LCD panel.
 6. If [] blinks on the LCD panel, it means that the film is not properly loaded. Reload the film again.
- When the main switch is turned OFF, the number of frames or [] indication will remain for 5 seconds on the LCD panel.

Film and Film Speed Setting.

- Use a DX-coded film with ISO rating from 25 to 1600. When any of these films are loaded, the proper film speed is automatically set for the camera.
- Non-DX coded films cannot be used. If non DX-coded film is used, the camera automatically set the film speed to ISO 25.
- A film with ISO400 film speed is recommended to get less image blur and to cover more of photographic situations.
- Use high-speed films with ISO 800 or higher mainly for shooting indoors or in dimly-lit conditions.
- Use of negative color film (print film) is recommended.



VIEWFINDER DISPLAYS AND LAMP INDICATIONS

VIEWFINDER DISPLAYS

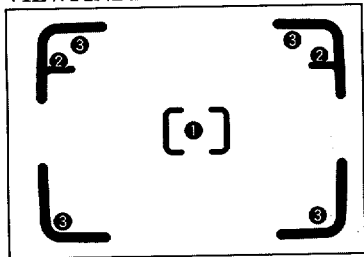

- 1 Autofocus frame**
Center this frame over the subject.
- 2 Close distance compensation frame**
When the camera-to-subject distance is less than 1m, compose the scene within this frame.
- 3 Picture area**
When taking a normal picture, compose the scene within this frame.

LAMP INDICATIONS

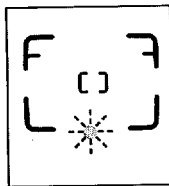

Lighting up:

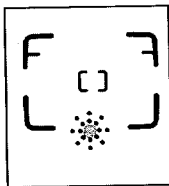

Blinking:

When you depress the shutter release button halfway down, the green lamp in the viewfinder lights up or blinks.

When the subject is in focus and the the flash is fully charged, the green lamp will light up to indicate that you can take the picture.

If either the camera-to-subject distance is less than 1m or the flash is being charged, the green lamp will blink and you cannot release the shutter.

- While the lamp is blinking, you cannot release the shutter.
- Ensure that the lamp is lit continuously before taking pictures.
- When the flash is being charged, [⚡] on the LCD panel also blinks.



TAKING PICTURES [Shooting distance: 0.6m (2ft) - ∞ (infinity)]



1. Composing the scene

After zooming the lens and composing your scene, center the autofocus frame over the main subject.

2. Checking the lamp indication

When the shutter release button is depressed halfway down, the camera focuses automatically.

- The subject closer than 0.6m (2ft) cannot be focused properly.
- The lamp blinks for one of the following reasons.

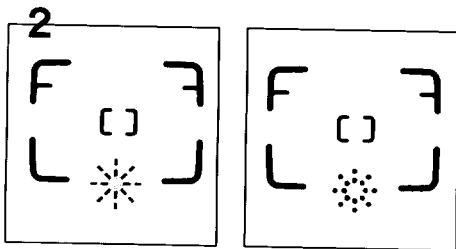

- 1 The subject is too close. Extend the camera-to-subject-distance until the green lamp is lit continuously.
 - 2 The flash is being charged. Lift your finger from the shutter release button for a few seconds until the flash is fully charged. Then depress the shutter release button again. When the flash is being charged, [] on the LCD panel also blinks.
- If you wish to focus on another subject, lift your finger from the shutter release button, recompose, and then depress the shutter release button halfway down again.
 - If the autofocus window is dirty, the autofocus may not function properly.

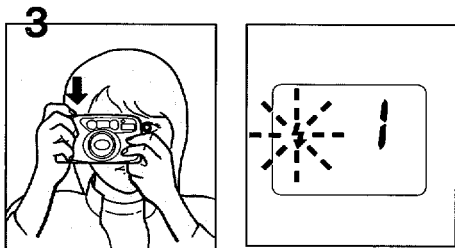

3. Shooting

Fully depress the shutter release button.

Note:

- When the shutter is released, the self-timer lamp momentarily lights up to indicate that a picture has been taken.

Flash effective ranges (Nega-color film used)

Lens	ISO		
	100	200	400
38 mm (◆◆◆)	0.6 - 3.5m (2.0-11.5ft)	0.6 - 5.0m (2.0-16.4ft)	0.6 - 7.0m (2.0-23.0ft)
70 mm (◆)	0.6 - 2.0m (2.0-6.6ft)	0.6 - 2.8m (2.0-9.2ft)	0.6 - 4.0m (2.0-13.1ft)

Automatic Flash Emission

When the shutter release button is depressed halfway down in low light, the flash is automatically charged and the lamp in the viewfinder lights up and [◆] will appear on the LCD panel indicating the flash is ready to discharge.

- The automatic flash emission is automatically set when the main switch is turned on.
- When the built-in flash automatically discharges, the camera uses a shutter speed of approx. 1/45 sec. when the ISO400 film is used.

Red-eye Reduction Flash Function

This camera incorporates a red-eye reduction function which lights up the self-timer lamp for approx. 1 second before the flash is discharged. For setting the red-eye reduction flash function, see page 18.



FOCUS LOCK SHOOTING

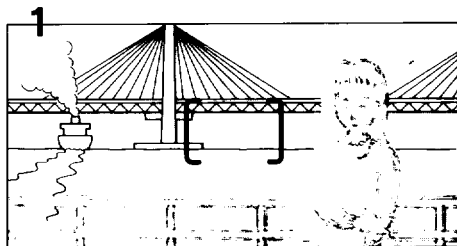

If you shoot without positioning the autofocus frame [] on the main subject as shown above, only the background will be in focus. When the main subject is off the autofocus frame in the center of the viewfinder, use the focus-lock technique. (Focus lock is the function to lock focus on an off-center subject.)

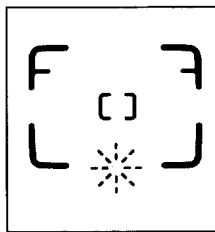
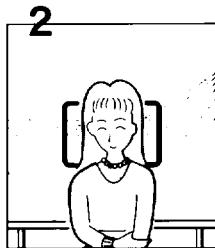

1. Focus on the subject with the autofocus frame [] .
2. When the shutter release button is depressed halfway down, the green lamp in the viewfinder lights up and the exposure and focus are temporarily locked.

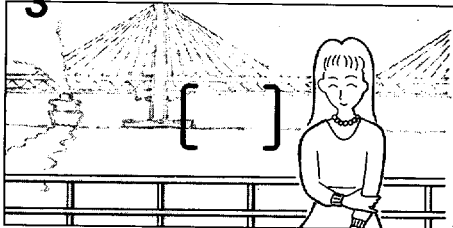
3

3. While holding the shutter release button halfway, re-aim the camera or recompose the picture, then release the shutter by depressing the shutter release button all the way.

Note:

- You can release the focus lock simply by lifting your finger from the shutter release button.

HARD-TO-AUTOFOCUS SUBJECTS

The autofocus system is highly precise, but not perfect. Some subjects may not focus as you wish. In this case, use the focus-lock technique on another subject near the actual one and equidistant from the lens. Subjects which may fool the autofocus system include:

- a) Black or very dark objects, which don't reflect much light (and therefore don't reflect infrared autofocus beams.)
- b) Wire netting, latticework, iron exercise-bars, etc.
- c) Flickering light sources such as neon signs, fluorescent lamps, TV images, sunlight coming through trees, etc. and subjects illuminated by these light sources.
- d) Glossy and reflective surfaces like glass, mirror, car bodies, etc.
- e) Fast-moving objects, like trains or automobiles in motion.
- f) Water jets, water surface, smoke, flame, fireworks, etc. which have no distinct or consistent form, or a subject in mist.



UNLOADING FILM (Remove the film from the camera in the shade or by using your body to shade the camera)

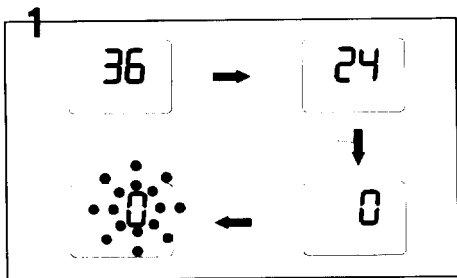

1. Rewinding the film

After you have exposed the last frame of the roll, the lens retracts and the film rewinds automatically. After rewinding, the motor stops, and [0] blinks as shown to indicate that the film has been rewound.

- [0] blinks for approx. 5 sec. after the whole film roll is rewound.
- A 24-exposure roll of film takes about 20 seconds to be rewound.
- The entire roll of film including the film leader is always rewound into the cartridge to prevent any part of the film being exposed to light.

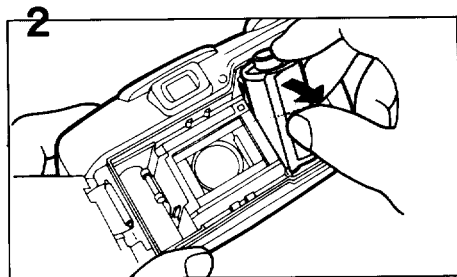

2. Unloading the film

To unload the film, open the back cover, and remove the cartridge from the chamber by pulling the top out first.

Notes:

- Never open the back cover until the whole film roll is rewound.
- The shutter may be released a frame or two even after the specified number of frames have been used up as indicated by the number of shots shown on the film canister. If this occurs, these extra frames may be lost in processing.

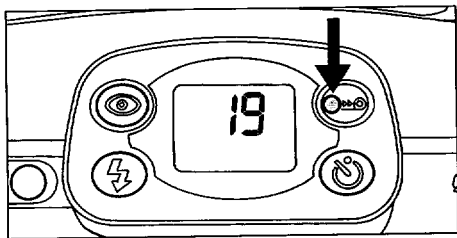

Rewinding a film in mid-roll

If you wish to unload a film before exposing all the frames, push the auxiliary rewind button with the protrusion part of the strap clamp.

- The lens retracts and then film rewinding starts.
- When rewind is completed, the motor stops and [0] blinks, indicating that the back cover may be opened safely.

TAKING BETTER PHOTOGRAPHS HOW TO SELECT MODES/RED-EYE REDUCTION FLASH MODE

To set various exposure modes, depress the mode button ❶. The mode selection will change each time that the mode button is depressed.

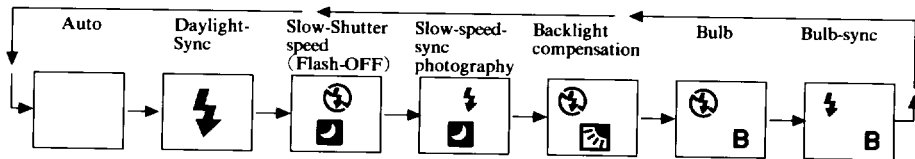

Turn the power on by depressing the main switch button.

- To set various required modes, depress the button ❶, each time.
- In any exposure mode, if the button ❶ is depressed after the shutter is released, the normal exposure mode is returned.

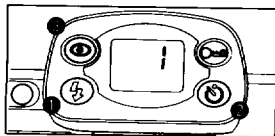

To set shooting modes, depress the drive button ❸.

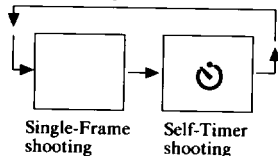

Red-Eye Reduction Flash Function

To reduce the red-eye phenomenon in the picture, depress the red-eye reduction flash button ❹. With this mode, the self-timer lamp lights up for approx. 1 second just before the main flash is discharged to reduce the appearance of the red-eye effect. To cancel this mode, depress the red-eye reduction button again.

DAYLIGHT – SYNCHRO SHOOTING

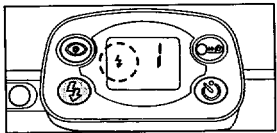

Depress the mode button until the [⚡] symbol appears on the LCD panel. The flash will discharge in both dark and bright conditions. When a portrait is taken with the subject in a backlight situation, the front of the subject may be cast in shadow. In such a case, use the Daylight-Synchro Shooting mode (Flash-ON mode) within the flash-effective range to take pictures. This will ensure that a picture is well exposed without any shadow. When you wish to discharge the flash, use this mode. In this mode, the flash will always discharge.

Note:

- Make sure you're within the flash effective range even when you use the built-in flash as a fill-in flash in daylight. See page 13.



Without Daylight-Sync



With Daylight-Sync

TAKING A PICTURES AT A SLOW SHUTTER SPEED

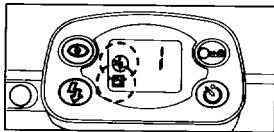

Slow Shutter Speed (Flash-Off)

Depress the mode button until the [⚡] symbol

appears on the LCD panel. In this mode, the flash does not discharge, and a picture is taken at a slow shutter speed up to approx. 1/3 second. Use it in places where the flash photography is prohibited, such as in theaters and museums. Furthermore, this mode is also useful for a natural existing light effect in low ambient photography.

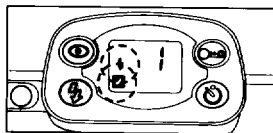

Slow-Speed-Synchro Shooting (Flash-On)

Depress the mode button to set the slow-shutter-sync

mode until the [⚡] symbol appears on the LCD panel. It is possible to photograph subjects and background in a balanced way (as shown in the photo) by using the built-in flash to properly expose the foreground subject and a slow-speed to expose the low light background.

Notes:

- When shooting in low light, the shutter speed gets slower, and camera shake is likely to blur your picture. Use of a tripod is recommended.
- Make sure you are within the flash effective range even when you use the built-in flash as a fill-in flash in daylight. See page 13.

BACKLIGHT COMPENSATION

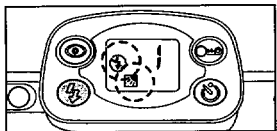

Purpose

Indoor portraits against an outside window, blue sky or other bright backgrounds

often result in underexposure because the exposure is automatically set for the background. Backlight Compensation makes good use of natural lighting to improve the balance of light between the subject and the rest of the picture.

How to Set

Depress the Mode Button until the [ ] symbol appears on the LCD panel.

Note:

- When using Backlight Compensation in a dimly-lit place, the shutter speed may be so slow that you should use a tripod to prevent camera shake.



Without Backlight Compensation



With Backlight Compensation

BULB, BULB-SYNCHRO SHOOTING

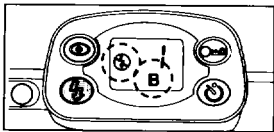

Bulb Mode [⚡ B]

Purpose

The shutter remains open as long as the shutter release button is held down. This mode is useful for long exposures required for shooting fireworks and night scenes, for example.

How to Set

Depress the mode button until [⚡ B] appears on the LCD panel.

Note:

The camera should be mounted on a tripod so that the camera will be steady.

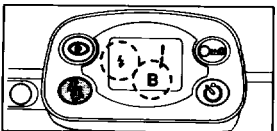

Bulb-Synchro Mode [⚡ B]

Purpose

This mode lets you use the flash in addition to the Bulb mode, so you can take a portrait photograph with a night scene in the background, for example.



Bulb mode, approx. 3 sec. (ISO100)

How to Set

Depress the mode button until [⚡ B] appears on the LCD panel.

Notes:

- Make sure you're within the flash effective range even when the Bulb-Synchro Mode is in used. See page 13.
- The camera should be mounted on a tripod so that the camera will be steady.

SELF-TIMER PHOTOGRAPHY

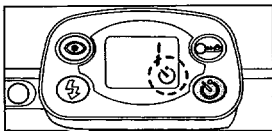

Self-Timer

Purpose

Use the self-timer if you wish to get in the picture.

Use of a tripod is

recommended.

How to Use

- Depress the drive button until [⊙] appears on the LCD panel.
- Focus on the subject first by depressing the shutter release button halfway, and then depress the shutter button fully.

How to Cancel

- To stop the self-timer operation at any time after it's been activated, push the main switch again.
- When the self-timer is working, the lamp lights up for approximately 7 seconds and then will start blinking 3 seconds before the shutter is released, letting you know when to smile.

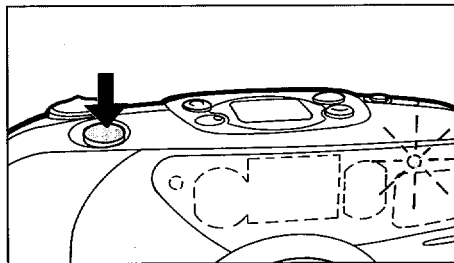

Notes on the self-timer shooting

- Use of a tripod is recommended.
- Keep in mind that when starting the Self-Timer while standing in front of the camera, the camera may not focus on the subject.
- When you want to use the flash with the self-timer, ensure that the lamp is lit indicating the flash has been charged before operating the self-timer.

DATE MODEL

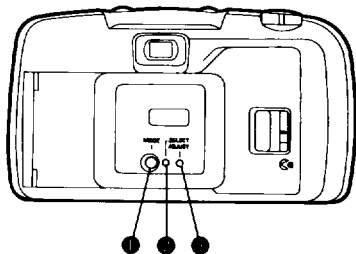

If you purchased the DATE model, read this section. The DATE model records dates up to the year 2019 on pictures.

Switching the Mode

Press the MODE button ❶ with your finger, the mode on the LCD panel switches as shown in the chart.

Notes:

- “----” indicates no data will be imprinted.
- “M” on the LCD panel indicates “Month”.
- Use the strap clamp’s protrusion to depress the SELECT and ADJUST buttons.

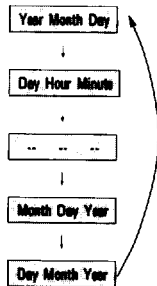

* The date in the picture above is simulated.

Correcting the date

1. Depress the SELECT button ② to make a different category of digits on the LCD panel that you want to change blink.
2. Depress the ADJUST button ③ to change digits of the specified category you chose with the SELECT button ②. Digits increase by one each time you depress the ADJUST button ③. Holding down the button will advance digits continuously.
3. After the data has been adjusted, depress the SELECT button ② each time until blinking stops.
 - Depress the SELECT button ② each time. The bar mark (—) appears on the LCD panel, indicating that data imprinting choices are possible.
 - The blinking “:” allows precise fine-tuning of the internal clock to the beginning of a specified minute. To do so, depress the mode button ① until “Day-Hour-Minute” digits appear and then depress the SELECT button ② to make the “:” blink. Then depress the adjust button ③ in sync with a time signal.
 - If you release the shutter while the blinking data is being corrected, the data cannot be imprinted.

Operational precautions



The data on the LCD panel is imprinted on each frame you expose.

- “Year-Month-Day” and “Day-Hour-Minute” cannot be imprinted at the same time.
- As you release the shutter, the bar(—) mark on the display blinks for a few seconds, indicating the data has been imprinted.
- If there is a white or yellow object in the corner of the picture where the data is imprinted, the data may be difficult to read. When composing your photographs, try to avoid brightly-colored subjects in that corner.

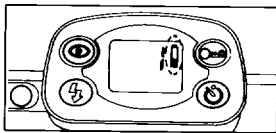
**BATTERY EXHAUSTION WARNING AND LOADING/
REPLACING BATTERY Use one 3V lithium battery (CR-123A or DL-123A).**



Battery exhaustion warning

When the battery is nearly exhausted, the battery symbol [] appears on the LCD panel to warn you. Replace the battery as soon as possible. When [] starts blinking, no operations can be performed.

Battery life (using 24-exposure film rolls):
Approx. 15 rolls

Using flash 50% of the time (using the CR123A battery and under Pentax testing conditions). Actual battery life/performance may vary drastically depending on usage of Auto-Focus, Power Zoom, Flash and external conditions such as temperature and freshness of the battery.

Notes on replacing the battery:

- Ensure that the power is off before replacing the battery.
- After the battery is replaced, correct the time and date.

26

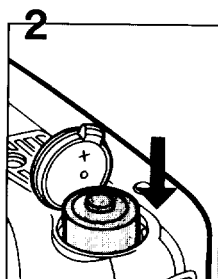
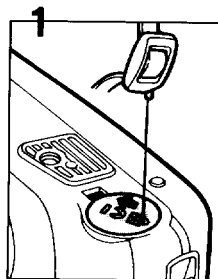

Ensure that the power is off before replacing the battery.

1. Open the battery chamber cover by using the strap clamp's protrusion.
 2. Insert one lithium battery with the plus/minus (+/-) slides matching the indications in the battery compartment.
 3. Close the battery chamber cover. Ensure that the cover is locked with a click.
- If the battery is correctly loaded, the zoom lens moves slightly and the motor operates for a few seconds.
 - On the DATE MODEL, the data is initialized when the battery chamber cover is opened.

PRACTICAL SHOOTING GUIDE



Flash photography

Taking a picture in low light situations.	p.12
Minimizing the red-eye effect.	p.13
Taking a portrait when the subject's face is cast in shadow.	p.19
Taking a picture of people with sunset scenery in the background.	p.20
Taking a picture of people with night scenery in the background.	p.22



Taking pictures of people in various situations

Taking a portrait picture whose face is cast in shadow.	p.19
Taking a picture of people with sunset scenery in the background.	p.20
Taking a picture of people with night scenery in the background.	p.20
Putting yourself into a picture.	p.23



Landscape photography

Taking a picture of people with sunset scenery in the background.	p.20
Taking a picture of night scenery.	p.22
Taking a picture of people with night scenery in the background.	p.22



Others

Imprinting date on a picture.	p.24
------------------------------------	------

TROUBLESHOOTING

What appears troublesome may be easily remedied. Here are some problems that may occur and their remedies.

Symptoms	Causes and Remedies
1. The shutter cannot be released.	<ul style="list-style-type: none">• Is the main switch turned off? If so, turn it on. See page 5.• Is the battery exhausted? Replace it or insert new battery if it is exhausted. See page 26.• Is [0] blinking on the LCD panel? If so, the film has been used up. Insert a new roll. (See page 8.)
2. My printed pictures don't look very clear.	<ul style="list-style-type: none">• Did you position the autofocus frame on your subject? See page 12.• Did you obstruct the autofocus window with your fingers, hair or other object when you depress the shutter release button? See page 6.• Is the autofocus window dirty? Wipe it off. See page 12.
3. Zoom lens retracted automatically (the power is turned off automatically)	<ul style="list-style-type: none">• Did you leave the camera unused for over 3 minutes after the main switch was turned on? The power is automatically switched off if the camera is left unused for over 3 minutes. See page 5.

Symptoms	Causes and Remedies
4. The flash discharges, though it is not dark.	<ul style="list-style-type: none"> • Daylight sync mode has been set. See page 19.
5. The [H] or [U] mark is displayed on the LCD panel.	<ul style="list-style-type: none"> • If either mark disappears when the zoom lever is moved, the camera is ready for use. The camera may be defective if either mark appears often.

Flash effective ranges other than ISO 100, 200 or 400 (Nega-color film used)

Lens \ ISO	25	50	800	1600
38mm (◆◆◆)	0.6-1.8m (2.0-5.9ft)	0.6-2.5m (2.0-8.2ft)	0.8*-10.0m (2.6*-32.8ft)	1.1*-14.0m (3.6*-45.9ft)
70mm (◆)	0.6-1.0m (2.0-3.3ft)	0.6-1.4m (2.0-4.6ft)	0.6-5.6m (2.0-18.4ft)	0.6-8.0m (2.0-26.2ft)

* With high speed film, overexposure may occur at close range due to the film's high speed.

SPECIFICATIONS

Type:	35mm fully automatic leaf-shutter with built-in zoom lens and auto flash
Film:	Auto film speed setting with 35mm perforated DX-coded film with ISO rating from 25-1600 (1EV step). Non-DX coded films are automatically set to ISO25
Format:	24 × 36mm
Film loading:	Auto film loading. Closing the back cover will automatically wind the film to first exposure.
Film winding:	Auto film-winding, single frame advance mode.
Film rewinding:	Auto start at the end of roll. Auto stop upon completion of rewinding. Rewinding time: approx. 20 sec. with 24-exposure film. Rewinding in mid-roll provided. Rewinding in mid-roll provided.
Frame number:	Automatic readout of successive frame numbers in ascending order when shooting, and descending order when rewinding.
Lens:	Pentax power zoom 38-70mm f/4.8-8.5 5 elements in 5 groups, Angle of view: 59° - 34.5°.
Focusing system:	Pentax infrared active autofocus with focus lock, Range: 0.6m(2ft)-infinity. Maximum magnification approx. 1/7.6X. Focus lock is provided.
Zooming:	Electronic zoom
Shutter:	Programmed AE electronic shutter with speed approx. 1/320-1/3 sec. Bulb. Electromagnetic release.
Self-timer:	Electronic red lamp indication. Approx. 10 sec. Cancellation after activation is possible.
Viewfinder:	Albada-bright frame. 83% of field of view ratio. Magnification: 0.39X (38mm WIDE) - 0.66X(70mm TELE), Picture frame, Close distance compensation frame, Green lamp lighting (○): possible to take a picture, Green lamp blinking: When subject is too close and/or flash is being charged.

Exposure control:	Programmed auto-exposure control. Range: EV10-EV17 at 38mm WIDE, EV11.5-EV18.5 at 70mm TELE in Auto or Daylight-Synchro mode (ISO 400), EV8.0-EV17 at 38mm WIDE EV8.0-EV18.5 at 70mm in Slow-Shutter-Speed mode,
Backlight compensation:	+ 1.5EV
Flash:	Built-in flash with red-eye reduction mode, Automatic flash emission in low-luminance, Flash ON=Day-light Synchro/Slow-Shutter-Speed Synchro (up to 1/3 sec.), Flash-OFF=Flash override, Bulb-Synchro,
Flash effective range:	0.6-7.0m (38mm WIDE), 0.6-4.0m (70mm TELE) (ISO 400 film used).
Flash recycling time:	Approx. 5 sec. under Pentax testing conditions.
Battery source:	One lithium battery CR123A or the equivalent
Battery life:	Approx. 15 rolls of 24-exposure film when 50% of shooting uses flash (under Pentax testing conditions)
Size & Weight:	134(W)x 74(H)x 47.5(D)mm (5.3"x2.9"x1.9") 240g(8.5oz) without battery
DATE model:	
Date mechanism:	Crystal quartz controlled; LCD with digital clock, auto calendar up to 2019.
Imprinting mode:	"Year,Month and Day", "Day,Hour and Minutes", "---- blank", "Month, Day and Year" or "Day, Month and Year".
Size & Weight:	134(W)x 74(H)x 50(D)mm (5.3"x2.9"x2.0") 250g(8.8oz) without battery

SPECIFICATIONS ARE SUBJECT TO CHANGE AT ANY TIME WITHOUT NOTIFICATION OR ANY OBLIGATION ON THE PART OF THE MANUFACTURER.

WARRANTY POLICY

All Pentax cameras purchased through authorized bona fide photographic distribution channels are guaranteed against defects of material or workmanship for a period of twelve months from date of purchase. Service will be rendered, and defective parts will be replaced without cost to you within that period, provided the equipment does not show evidence of impact, sand or liquid damage, mishandling, tampering, battery or chemical corrosion, operation contrary to operating instructions, or modification by an unauthorized repair shop. The manufacturer or its authorized representatives shall not be liable for any repair or alterations except those made with its written consent and shall not be liable for damages from delay or loss of use or from other indirect or consequential damages of any kind, whether caused by defective material or workmanship or otherwise; and it is expressly agreed that the liability of the manufacturer or its representatives under all guarantees or warranties, whether expressed or implied, is strictly limited to the replacement of parts as herein before provided. No refunds will be made on repairs performed by non-authorized Pentax service facilities.

Procedure During 12-month Warranty Period

Any Pentax which proves defective during the 12 month warranty period should be returned to the dealer from whom you purchased the equipment or to the manufacturer. If there is no representative of the manufacturer in your country, send the equipment to the manufacturer, with postage prepaid. In this case, it will take a considerable length of time before the equipment can be returned to you owing to the complicated customs procedures required. If the equipment is covered by warranty, repairs will be made and parts replaced free of charge, and the equipment will be returned to you upon completion of servicing. If the equipment is not covered by warranty, regular charges of the manufacturer or of its representatives will apply. Shipping charges are to be borne by the owner. If your Pentax was purchased outside of the country where you wish to have it serviced during the warranty period, regular handling and servicing fees maybe charged by the manufacturer's representatives in that country. Notwithstanding this, your Pentax returned to the manufacturer will be serviced free of charge according to this procedure and warranty policy.

In any case, however, shipping charges and customs clearance fees are to be borne by the sender. To prove the date of your purchase when required, please keep the receipts or bills covering the purchase of your equipment for at least a year. Before sending your equipment for servicing, please make sure that you are sending it to the manufacturer's authorized representatives or their approved repair shops, unless you are sending it directly to the manufacturer. Always obtain a quotation for the service charge, and only after you accept the quoted service charge, instruct the service station to proceed with the servicing.

The local warranty policies available from Pentax distributors in some countries can supersede this warranty policy. Therefore, we recommend that you review the warranty card supplied with your product at the time of purchase, or contact the PENTAX distributor in your country for more information and to receive a copy of the warranty policy.

STATEMENT OF FCC COMPLIANCE

This device complies with Part 15 of the FCC Rules. Operation is subject to the following two conditions : (1) This device may not cause harmful interference, and (2) this device must accept any interference received, including interference that may cause undesired operation.

Changes or modifications not approved by the party responsible for compliance could void the user's authority to operate the equipment. This equipment has been tested and found to comply with the limits for a Class B digital device, pursuant to part 15 of the FCC Rules. These limits are designed to provide reasonable protection against harmful interference in a residential installation. This equipment generates, uses and can radiate radio frequency energy and, if not installed and used in accordance with the instructions, may cause harmful interference to radio communications. However, there is no guarantee that interference will not occur in a particular installation. If this equipment does cause harmful interference to radio or television reception, which can be determined by turning the equipment off and on, the user is encouraged to try to correct the interference by one or more of the following measures :

- Reorient or relocate the receiving antenna.
- Increase the separation between the equipment and receiver.
- Consult the dealer or an experienced radio/TV technician for help.

This Class B digital apparatus meets all requirements of the Canadian Interference-Causing Equipment Regulations.

NAMES OF WORKING PARTS

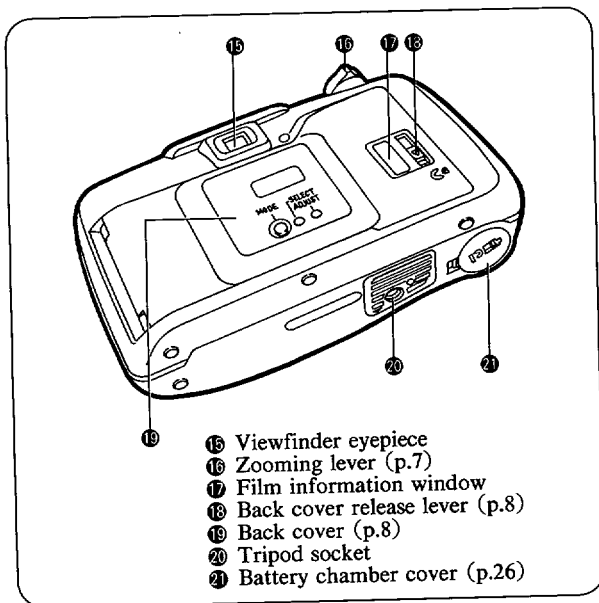

FOR YOUR REFERENCE, KEEP THIS CARD WITH THE CAMERA.

PENTAX® IQZOOM EZY

BULB :
 CAMERA STAYS OPEN FOR AS LONG AS YOU PRESS THE SHUTTER RELEASE BUTTON



RED-EYE REDUCTION ON



DAYLIGHT FLASH ON



FILM REWINDING IN MID. ROLL



SELF-TIMER ON (10 SEC.)



LOW LIGHT FLASH OFF



LOW LIGHT FLASH ON



BACKLIGHT COMPENSATION ON



BULB FLASH OFF



BULB FLASH ON

* CAMERA FLASHES AUTOMATICALLY WHEN NO ICONS APPEAR



**FOR YOUR REFERENCE, KEEP
THIS CARD WITH THE CAMERA.**

PENTAX® IQZ_{OOM}EZY

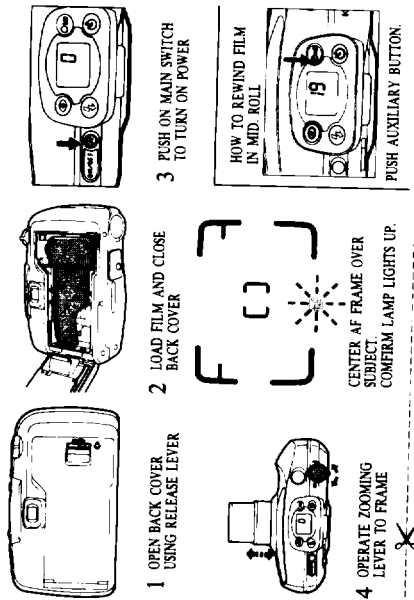

LCD PANEL

All indications will not actually appear simultaneously as shown.

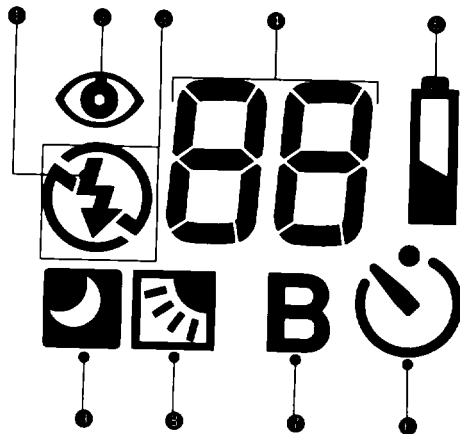

- ① Flash ON (p.19)
- ② Red-eye Reduction Flash mode (p.13,18,33)
- ③ Flash OFF (p.20)
- ④ Exposure Counter (p.10)
- ⑤ Battery Exhaustion Warning (p.26)
- ⑥ Self-Timer (p.23)
- ⑦ Bulb (p.22)
- ⑧ Backlight compensation (p.21)
- ⑨ Slow Shutter Speed (p.20)



Asahi Optical Co., Ltd. 11-1, Nagata-cho 1-chome, Chiyoda-ku, Tokyo 100, JAPAN

Pentax Europe n.v. Weveldlaan 3-5, 1930 Zaventem, BELGIUM

Pentax GmbH. Julius-Vosseler-Strasse, 104, D-22527 Hamburg, GERMANY

Pentax U.K. Limited. Pentax House, Heron Drive, Langley, Slough SL3 8PN, U.K.

Pentax France S.A. Z.I. Argenteuil, 12, rue Ambroise Croizat, 95100 Argenteuil, FRANCE

Pentax Benelux B.V. (for Netherlands) Spinveld 25, 4815 HR Breda, NETHERLANDS

(for Belgium & Luxemburg) Weveldlaan 3-5, 1930 Zaventem, BELGIUM

Pentax (Schweiz) AG Industriestrasse 2, 8305 Dietlikon, SWITZERLAND

Pentax Scandinavia AB Falhagsleden 57, 75127 Uppsala, SWEDEN

Pentax Corporation 35 Inverness Drive East, Englewood, Colorado 80112, U.S.A.

Pentax Canada Inc. 3131 Universal Drive, Mississauga, Ontario L4X 2E5, CANADA