

OPERATING MANUAL
MODELS H3v / H1a

HONEYWELL PENTAX



Major working parts of the
HONEYWELL PENTAX
Models H3v and H1a

- a** - Shutter speed dial
- b** - Rapid wind lever
- c** - Automatic re-setting film exposure counter
- d** - Shutter release
- e** - 'Cocked' indicator
- f** - Diaphragm ring
- g** - Diaphragm and distance index
- h** - Depth-of-field guide
- i** - Distance scale
- j** - Distance scale ring
- k** - X flash terminal
- l** - FP flash terminal
- m** - Back lock
- n** - Preview lever
- o** - D-ring for neck strap
- P** - Film type reminder dial
- q** - Rewind knob
- r** - Rewind crank
- s** - Self-timer cocking wheel
- t** - Self-timer release button

The standard lens of H1a is Super-Takumar 35mm $f/2$, and its top shutter speed is $1/500$ second. Unlike H3v, H1a has no self-timer. Otherwise, the operating parts of H3v are same as those of H1a.

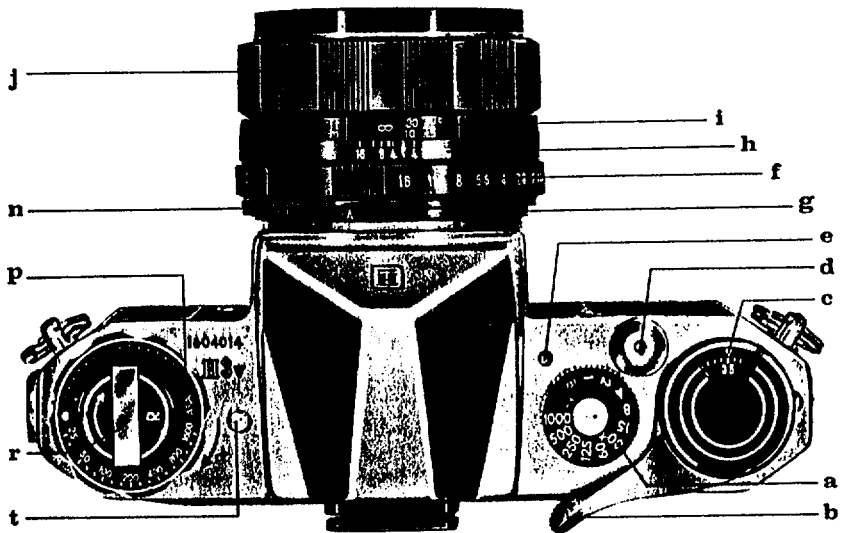
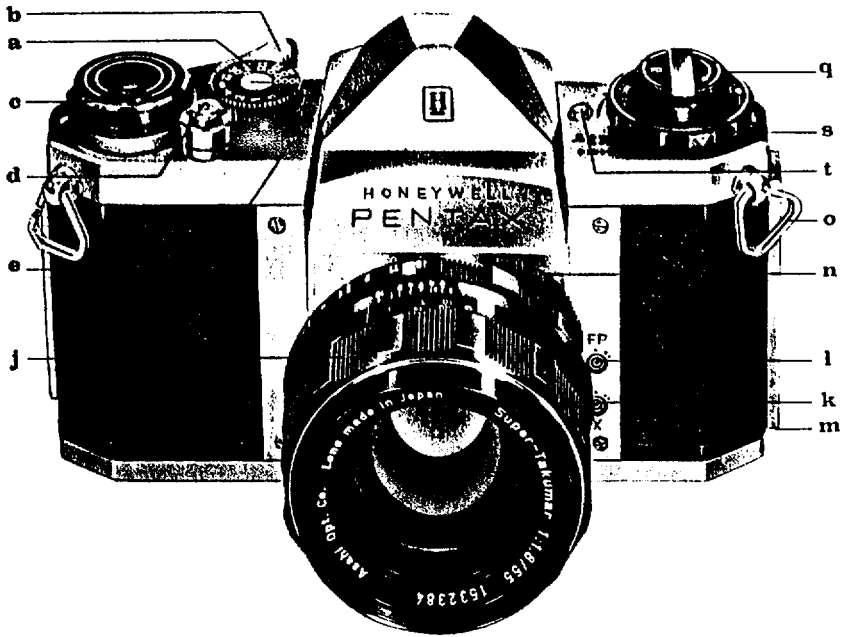

MAJOR FEATURES OF THE HONEYWELL PENTAX H3v AND H1a

Here's why the Honeywell Pentax cameras are the outstanding values in their field:

Type	Single-lens reflex
Film & picture size	35mm film (20 or 36 exposures); 24mm x 36mm
Standard lenses	H3v - Super-Takumar 55mm 1/1.8 with fully automatic diaphragm H1a - Super-Takumar 55mm 1/2 with fully automatic diaphragm

H3v

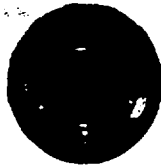

H1a

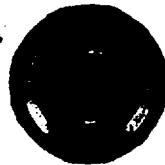

Shutter	Focal plane shutter; single, non-rotating shutter speed dial. Speeds: H3v - T (Time), B (Bulb), 1, 1/2, 1/4, 1/8, 1/15, 1/30, 1/60, 1/125, 1/250, 1/500 & 1/1000 sec. H1a - Same as above up to 1/500 sec.
---------	---

H3v

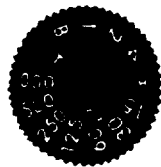

H1a

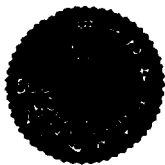

Finder and focusing	Pentaprism finder with microprism Fresnel lens brightened ground glass. Life size image viewing and focusing with standard 55mm lens.
Reflex mirror	Instant return type.
Rapid film advance	Single-stroke rapid wind lever transports film and cocks shutter.
'Cocked' indicator	When the shutter is cocked, a red disc appears in a small window alongside the shutter speed dial.
Film rewind	Rapid rewind crank speeds film take-up.
Double exposure	Coupled film wind and shutter cocking prevents double exposure.
Lens mount	Threaded lens mount for interchangeable lenses. Adapter rings are available for use with Leica-type and Asahiflex lenses.
Flash synchronization	FP and X flash terminals.
Film type dial	Color coded film type reminder dial with ASA ratings for color and black-and-white films.
Accessory clip	Grooves located on both sides of the viewfinder window frame accept Honeywell Pentax Clip-on Exposure Meter, accessory clip, 90° finder, magnifier, and other accessories.
Exposure counter	Automatic re-setting film exposure counter automatically counts the number of exposures made.
Self-timer	Tiny self-timer is built into the H3v body.

MAINTENANCE OF YOUR CAMERA

1

Protect your camera from humidity, salty air and dust. In extremely hot weather, try to keep your camera cool. Never put it in the glove compartment or on the rear window sill of your car. When extremely cold, try to keep the camera warm.

2

To remove grit or dirt from the camera body, use a soft brush or a dry soft piece of cloth. For the lens, use only a spray of air, soft lens tissue, or a camel hair brush. For the reflex mirror, use a spray of air or a soft camel hair brush only. Never wipe the mirror or lens surface with cloth.

3

Never use oil in your camera and do not touch the shutter curtains.

4

When advancing the film, be sure to stroke the rapid wind lever all the way until it stops.

5

Do not use the Auto-Takumar 55mm f/1.8 lens with a lens number smaller than 462500 with the SV and S1a camera bodies, for its automatic diaphragm will not work correctly due to modification and improvement of the Instant Return Mirror and automatic diaphragm mechanisms of these new models.

6

If your camera should need repair, do not try to fix it yourself. Take it to the dealer from whom you purchased it. Please refer to the Warranty Policy described on the last page of this operating manual.

7

The length of the tripod's screw should not exceed the normal length of 3/16" (4.5mm). Do not extend it longer than this length when mounting your camera on tripod. Forcing longer screws into the tripod socket of the camera will damage the mechanism.

HOW TO HOLD YOUR CAMERA



In horizontal position A. Hold the camera firmly with your left hand, and draw your arm close to your body.

In vertical position B. Hold your camera tightly to your forehead with your left hand, and draw your right arm close to your body.

In vertical position C. Hold your camera tightly to your forehead with your left hand, raise your right arm and draw your left arm to your body.

As a general rule, your camera should be held more firmly by the left hand which does not release the shutter. If you hold your camera with the right hand—the hand which releases the shutter—it may cause camera movement. Very often, pictures which are not sharp are due to movement of the camera.

When you focus with the camera held horizontally (Position A), hold the lens barrel as illustrated in photograph. Put the camera on your left hand thumb and little finger. Turn the distance scale ring with your thumb and index finger.

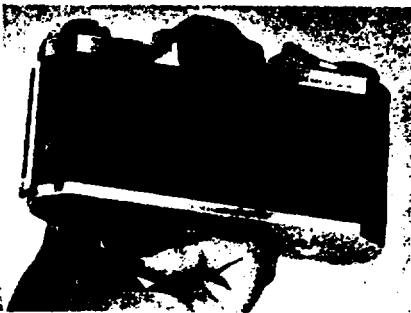

When holding the camera vertically, some people release the shutter with the thumb (Position B), while others release it with the index finger (Position C). Position C is more desirable for fast focusing and shooting. With the Honeywell Pentax, whether held vertically or horizontally, you can see your subject image through the taking lens, and this enables you to compose, focus and shoot with a minimum of time and effort.

BEFORE TAKING PICTURES

- 1 Set the preview lever ⑩ in 'A' (auto-
matic) position for bright full-aperture
viewing.
- 2 Cock the rapid wind lever ⑪ all the
way until it stops.
- 3 Select the f stop you want by setting
the diaphragm ring ①.
- 4 Set the proper shutter speed by turning
the shutter speed dial ⑫ either way.
- 5 Compose your picture through the view-
finder.
- 6 Get the clearest image of your subject
by turning the distance scale ring ⑬.
- 7 Then trip the shutter.
- 8 To view exact depth of field at different
apertures, move the preview lever ⑩
to 'M' (manual) position, and view your
focused subject by turning the diaphragm
ring ①.

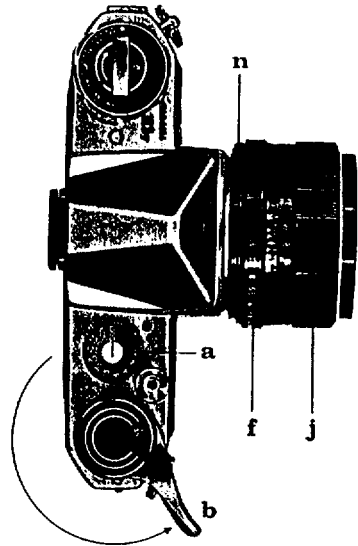

FILM LOADING

Avoid direct sunlight when loading
your film.

- 1 Open the back by pulling
out the lock ⑭.
- 2 Pull out the film rewind knob
⑮ completely, place the film
cassette into the cassette
chamber ⑯, and push back
the rewind knob. Draw out
the film leader and insert it
into the slit ⑰ of the take-up
spool ⑱. If the slit is not in
a proper position to insert the
film leader, turn the take-up
spool with your finger.
- 3 Turn the rapid wind lever ⑲
and make sure that both
sprockets ⑳ have properly
engaged the film perforations.
Close the back and fasten
the lock ⑭.

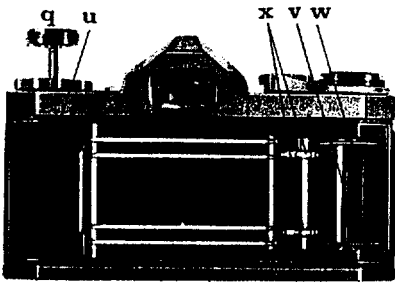

FILM WIND AND REWIND

- 1 Before turning the rapid wind lever **(D)**, slowly turn the film rewind knob **(C)** clockwise until a slight resistance is felt. This prevents loosening or warping of the film.
-

- 2 The first portions of the film can not be used for picture taking as they have already been exposed to light. Generally, two blank exposures should be made before taking your first picture. Cock the rapid wind lever until it stops. Watch to see that the film rewind knob automatically turns counter-clockwise, indicating that the film is moving from cassette to take-up spool. Trip the shutter. Cock the rapid wind lever and trip the shutter again. Your camera is now ready for the first picture. When cocking the rapid wind lever for the first picture, the exposure counter **(E)** automatically turns to '1', indicating that the first picture is ready to be taken. ALWAYS COCK THE RAPID WIND LEVER COMPLETELY WITH A FULL STROKE.
-

- 3 After the final picture on the roll (20 or 36 exposures) has been taken, the rapid wind lever will not turn all the way as you stroke it. This indicates that the final picture has been taken on your film, and that the film must be rewound. **DO NOT** open the back of the camera, or all exposed frames will be ruined.
-

- 4 Unfold the film rewind crank **(F)**.

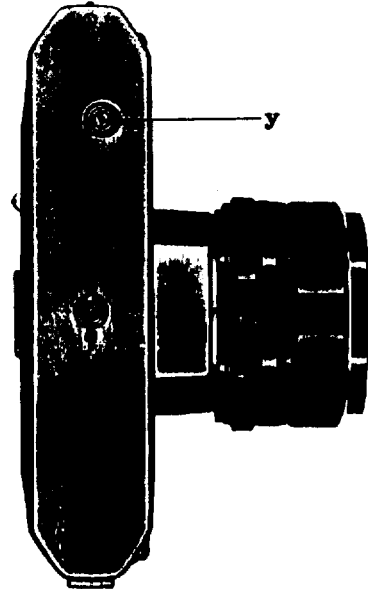
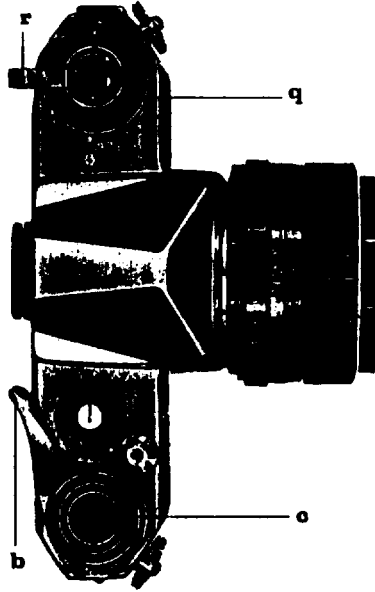

- 5** Depress the film rewind release button ④. Turn the rewind crank to rewind the film into the film cassette. The film rewind crank permits rewinding at a smooth, even rate. (Under some atmospheric conditions, erratic or too rapid rewinding will cause static electricity marks on the film.) You will feel the tension on the rewind crank lessen as the leader end of the film slips off the take-up spool.

Stop rewinding when you feel this happen. **AVOID DIRECT SUNLIGHT WHEN UNLOADING YOUR FILM.** (The rewind release button will return to normal position as you load your next film and turn the rapid wind lever.)

- 6** Open the back, pull out the film rewind knob ④, and remove the film cassette. Bend the leader end of the film to indicate that the film is exposed and ready for development.
-

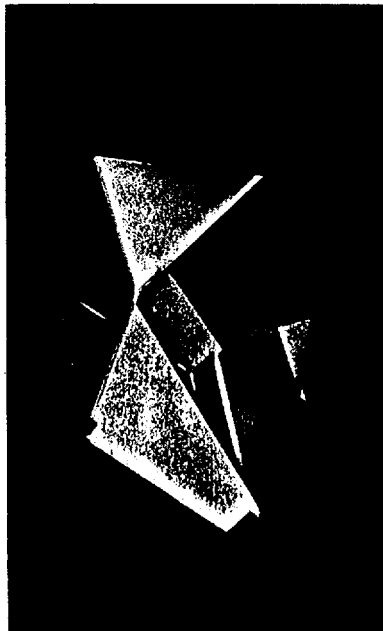
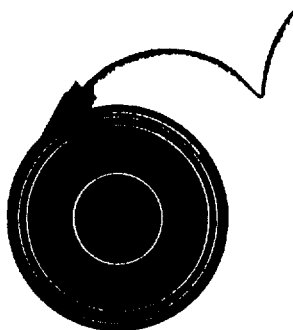

Little Jewel

This gem-like object is a pentaprism—nearly two solid ounces of finest optical glass. Ground and polished to extremely fine tolerances, it contains 25 distinct surfaces and is a thing of beauty, yet it dwells out of sight within the innards of Honeywell Pentax cameras.

BRIGHT FIELD FOCUSING

- 1** You can start viewing and focusing before and after cocking the rapid wind lever. When the preview lever ⑩ is in 'A' (automatic) position, the diaphragm is fully open except for the moment of exposure.
- 2** Turn the distance scale ring ① until your subject image is clearly in focus. It is not always necessary for you to view and focus with the diaphragm fully open. In bright sunlight, you can easily focus with the diaphragm closed to $1/5.6$ or $1/8$, and still observe the depth of field. It is easier, however, to focus with the diaphragm fully open as your subject image is much brighter.

When the letter 'M' appears beside the lever ⑩, the lens is in manual position; when 'A' appears, it's in automatic position.



MICROPRISM

Honeywell Pentax cameras have a Fresnel lens with a microprism center underneath the ground glass. As you look through the finder, you will see that the Fresnel lens consists of many concentric rings which provide the brightest possible image on the ground glass.

The microprism is the center portion of this diagram. When your subject is in focus, the image in the microprism will be sharp and perfectly clear. If your subject is not in focus, the H3's microprism will break the image up into many small dots, much like an engraver's screen, while a number of parallel diagonal lines will appear in the microprism of the H1a also breaking up your subject's image. You can focus on your subject at any portion of the ground glass.

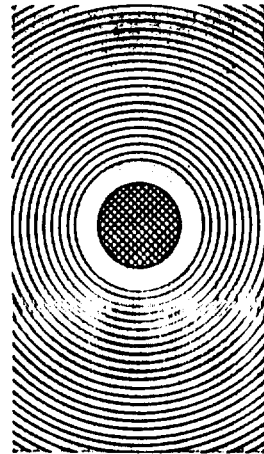

AUTOMATIC DIAPHRAGM

When the preview lever ⑩ is in "A" (automatic) position, the fully automatic diaphragm is at its largest aperture at all times, except for the instant of exposure, no matter what aperture is set on the diaphragm ring. When you release the shutter, the diaphragm automatically stops down to the predetermined aperture and the shutter curtains start traveling instantly. When the exposure is completed, the diaphragm reopens to maximum aperture completely automatically, and you are ready to compose, focus, and shoot your next picture. If you wish to visually check exact depth of field before making the exposure, move the preview lever to "M" (manual) position. This stops the diaphragm to the aperture selected and shows you exactly how much depth of field will appear in your picture. The preview lever may be moved back to "A" (automatic) position before or after making your exposure, or, if you are making pictures in bright sunlight, it may be left in manual position, which permits a constant check of depth of field.

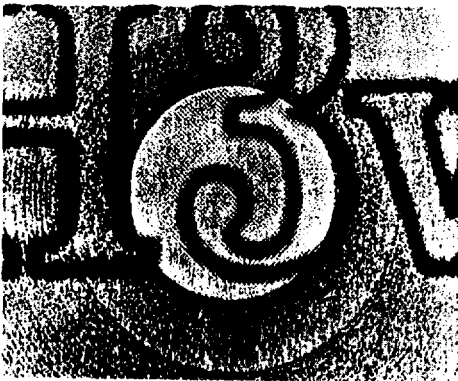

OUT OF FOCUS

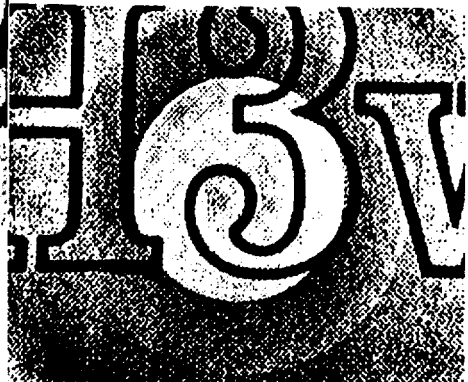

IN FOCUS

SHUTTER

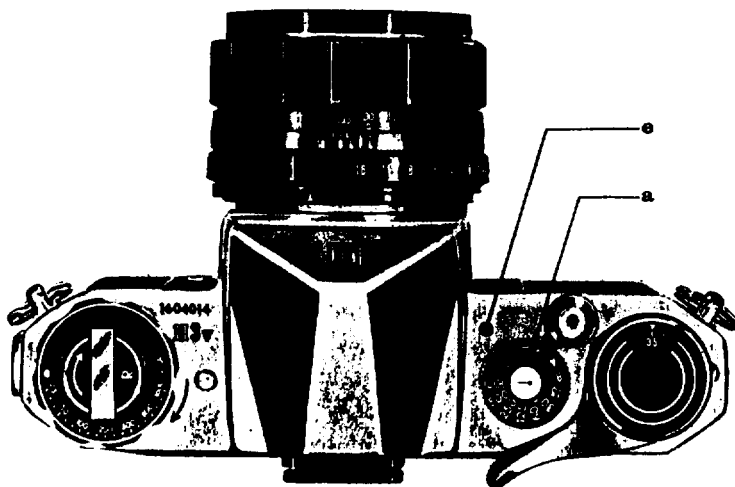

Turn the shutter speed dial ① clockwise or counter-clockwise to the desired shutter speed. The shutter speed may be set either before or after cocking the rapid wind lever. As you cock the shutter by turning the rapid wind lever, the 'cocked' indicator ② becomes red showing that the shutter is cocked. The indicator window blacks out as you trip the shutter button. For use of the X setting on the shutter speed dial, refer to page 14.

With the shutter speed dial set on B (bulb), the shutter will stay open as long as you depress the shutter button. As you release your finger from the shutter button, the shutter closes. When a long exposure is desired while using the B setting, attach a shutter release cable with a locking device to the shutter button. This will permit a "Time" exposure.

With the shutter speed dial set on T (time), the shutter stays open after the shutter button is released. To close the shutter, turn the shutter speed dial in either direction. Unless you turn the shutter speed dial, the shutter will not close.

CAUTIONS

- 1** At slow speeds—slower than $1/30$ —support your camera rigidly or use a tripod to prevent movement of your camera.
- 2** To protect the shutter mechanism, trip the shutter release before putting the camera out of use for any extended period.

DEPTH-OF-FIELD GUIDE

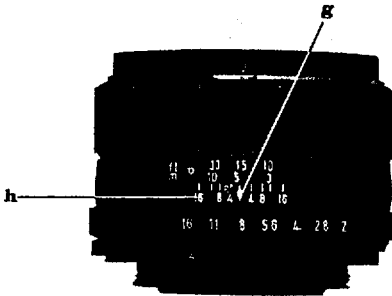

Depth of field is the range between the nearest and farthest distances which are in focus at different lens apertures.

If you want to know how great the depth of field is at a certain aperture, look at the depth-of-field guide (D). In the above photograph, the distance scale is set at 15 feet ... the lens is focused on a subject 15 feet away. The calibrations on each side of the distance index (E) correspond to the diaphragm setting and indicate the range of in-focus distance for different lens apertures. For example, if the lens opening of $1/8$ is to be used, the range on the distance scale ring covered within the figure 8 on the depth-of-field guide indicates the area in focus at that lens opening. You will note from the depth-of-field guide in the above photograph that the range from approximately 10 to 25 feet is in focus. Note that as the lens apertures change, the effective depth of field also changes. For the depth of fields at different apertures and distances, refer to page 13.

FILM TYPE REMINDER DIAL

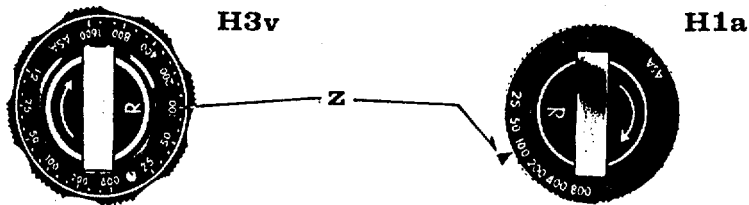

The ASA film speed rating of all 35mm films is given in the data sheet packed with each roll of film. As the ASA number increases, the sensitivity of the film also increases. For example, for two films of ASA 50 and ASA 200, the ASA 50 film requires 4 times more exposure than the ASA 200 film.

Use the film type dial to show what type of film is in your camera. Simply move the nipple (Z) and set the ASA number of your film opposite the red pointer. Use white figures for black-and-white film and green figures for color and other special films. To check whether the camera is loaded, turn the film rewind knob clockwise. If it turns freely, the camera is not loaded.

For ASA-DIN film speed conversion, refer to page 33.

DEPTH-OF-FIELD TABLE
SUPER-TAKUMAR 55mm LENS

Distance Scale f Setting	1'6"	2'	3'	5'	10'	15'	30'	∞
f/1.8	1' 5.9" 1' 6.1"	1'11.8" 2' 0.2"	2'11.5" 3' 0.6"	4'10.4" 5' 1.7"	9' 5.6" 10' 7.2"	13' 9.7" 16' 5"	25' 6.4" 36' 4.7"	168' 2.4" ∞
f/2	1' 5.9" 1' 6.1"	1'11.8" 2' 0.2"	2'11.4" 3' 0.6"	4'10.3" 5' 1.8"	9' 4.9" 10' 8"	13' 8.3" 16' 7.1"	25' 1.3" 37' 3.2"	151' 4.8" ∞
f/2.8	1' 5.9" 1' 6.1"	1'11.6" 2' 0.4"	2'11.2" 3' 0.8"	4' 9.6" 5' 2.6"	9' 2.3" 10'11.5"	13' 2.8" 17' 4"	23' 7" 41' 3.4"	108' 2.3" ∞
f/4	1' 5.8" 1' 6.2"	1'11.5" 2' 0.5"	2'10.8" 3' 1.2"	4' 8.6" 5' 3.8"	8'10.7" 11' 5.3"	12' 7.1" 18' 6.7"	21' 7.2" 49' 2.8"	75' 9.5" ∞
f/5.6	1' 5.6" 1' 6.4"	1'11.4" 2' 0.7"	2'10.4" 3' 1.8"	4' 7.4" 5' 5.4"	8' 6.1" 12' 1.7"	11'10.1" 20' 6.2"	19' 5.2" 66' 3.4"	54' 2.3" ∞
f/8	1' 5.5" 1' 6.5"	1'11" 2' 1"	2' 9.8" 3' 2.5"	4' 5.6" 5' 8.2"	8' 13' 4.4"	10'10.3" 24' 4.6"	16'10.7" 138' 2.8"	37'11.9" ∞
f/11	1' 5.4" 1' 6.7"	1'10.8" 2' 1.3"	2' 9" 3' 3.6"	4' 3.6" 5'11.8"	7' 5.4" 15' 3.7"	9'10.1" 31'10.8"	14' 6.2" ∞	27' 8.2" ∞
f/16	1' 5.2" 1' 7"	1'10.3" 2' 2"	2' 7.8" 3' 5.5"	4' 0.6" 6' 6.8"	6' 8.2" 20' 3"	8' 6.2" 66' 9.2"	11' 9.4" ∞	19' 1" ∞

Distance Scale f Setting	0.45 m.	0.6 m.	0.8 m.	1 m.	1.5 m.	2 m.	5 m.	10 m.	∞
f/1.8	0.45 0.45	0.59 0.61	0.79 0.81	0.98 1.02	1.46 1.54	1.93 2.07	4.57 5.52	8.39 12.38	51.27 ∞
f/2	0.45 0.45	0.59 0.61	0.79 0.81	0.98 1.02	1.46 1.54	1.92 2.08	4.53 5.59	8.24 12.72	46.15 ∞
f/2.8	0.45 0.45	0.59 0.61	0.78 0.82	0.98 1.03	1.44 1.56	1.89 2.12	4.36 5.86	7.70 14.27	32.98 ∞
f/4	0.44 0.46	0.59 0.61	0.78 0.82	0.97 1.04	1.42 1.59	1.85 2.17	4.13 6.33	7.01 17.48	23.10 ∞
f/5.6	0.44 0.46	0.58 0.62	0.77 0.83	0.95 1.05	1.39 1.63	1.80 2.25	3.87 7.09	6.27 24.97	16.52 ∞
f/8	0.44 0.46	0.58 0.62	0.76 0.85	0.93 1.08	1.34 1.70	1.73 2.38	3.53 8.65	5.41 70.27	11.58 ∞
f/11	0.44 0.47	0.57 0.63	0.74 0.87	0.91 1.11	1.29 1.79	1.64 2.57	3.18 11.93	4.62 ∞	8.44 ∞
f/16	0.43 0.47	0.56 0.65	0.72 0.90	0.87 1.17	1.22 1.96	1.52 2.95	2.73 32.75	3.71 ∞	5.82 ∞

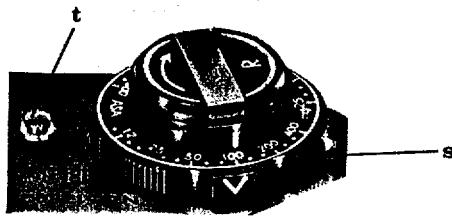

SELF-TIMER

After completely cocking the rapid wind lever, turn the self-timer cocking wheel ③ clockwise as indicated by the arrow mark until it stops. When you depress the self-timer release ④, the shutter will release in about 10 seconds. If you depress the release button after turning the wheel ③ about 50 degrees, the shutter will release in about 5 seconds. Remember that the shutter will release when the "V" mark on the side of the wheel ③ comes to the front. So, you always know when the shutter releases when taking your own self portraits. *The self-timer is built in the H3v model only. Turn the self-timer cocking wheel only after cocking the rapid wind lever.*

FLASH SYNCHRONIZATION

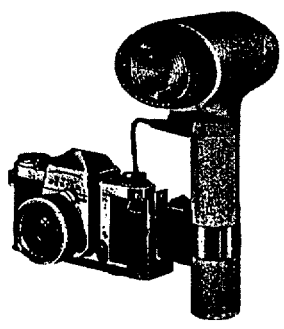

The Honeywell Pentax has two sets of terminals – FP and X. The table below shows which flash contact, which shutter speed and which flash bulb may be combined for maximum lamp efficiency. Unless these combinations are rigidly followed, there will be a failure in flash synchronization. Note the "X" setting between 60 and 30 on the shutter speed dial. The speed of this X setting is 1/50 of a second, and this indicates the highest shutter speed at which Honeywell Strobosars or other electronic flash units may be used.

Flash Terminal	Shutter Speed	$\frac{1}{1000}$	$\frac{1}{500}$	$\frac{1}{250}$	$\frac{1}{125}$	$\frac{1}{60}$	X	$\frac{1}{30}$	$\frac{1}{15}$	$\frac{1}{8}$	$\frac{1}{4}$	$\frac{1}{2}$	1	B
	H3v only													
FP	FP Class (screw base)													
	FP Class (bayonet base)													
X							F Class							
							Electronic flash							
							S Class							
							AG & M Class							

(Grey areas indicate recommended range)



INTERCHANGEABLE LENSES

The Honeywell Pentax offers many interchangeable lenses in a wide variety of focal lengths, all of which are highly respected by both professional and amateur photographers for their fine resolution. The photographic coverage of the various Takumar lenses is illustrated on page 16. With focal length longer than 55mm, the subject image is seen through the viewfinder larger than its life size. Regardless of the lens selected for your Honeywell Pentax, there is never need for an accessory viewfinder, ordinarily required for rangefinder type cameras.

When interchanging lenses, hold the lens by the distance scale ring. When attaching a lens, filter, or lenshood, do not screw it too tightly, as you may find it difficult to remove.

FIXED FOCUS SETTING

Because of the considerable depth of field of wide angle lenses, you can use them as fixed focus lens if the diaphragm and distance scales are set properly. For your convenience, the Super-Takumar lenses shown on page 17 have a fixed focus mark. Just align with the index the orange-colored figures of the diaphragm and distance scales, and the lens will be in fixed focus from foreground to infinity. You'll find this extremely convenient for fast shooting.

DIFFERENCE OF ANGLE OF TAKUMAR LENSES

All photographs were taken from the same location and distance from the subject.

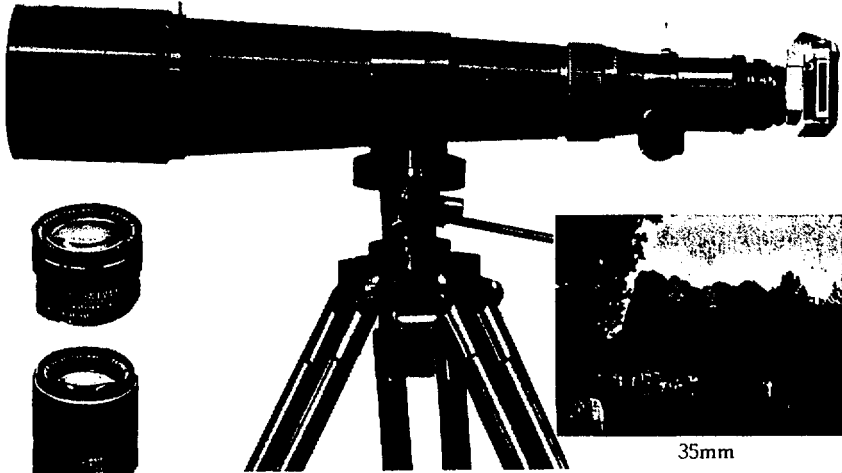

35mm



55mm



85mm



105mm



135mm



200mm



300mm



500mm



1000mm

Super-Takumar 28mm f/3.5

A new super-wide-angle lens of 7 elements, designed and produced to meet the most exacting of the professional requirements, this is *the* lens you professionals and advanced amateurs need to shoot more artistic photographs. Equipped with fully automatic diaphragm; ideal for architecture, fast-action and artistic photography.

Lens element 7
 Minimum aperture f/16
 Minimum distance 1.3 ft. (40 cm)
 Angle of view 75°
 Weight 9.2 ozs. (260 gr.)

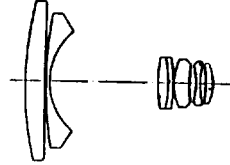
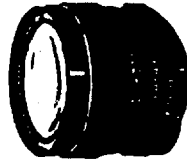

Super-Takumar 35mm f/2

One of the fastest wide-angle lenses for 35mm single-lens reflex cameras. Edge-to-edge sharp resolution at full aperture; unique lens design without distortion; perfect for architectural photography.

Lens element 8
 Minimum aperture f/16
 Minimum distance 1.5 ft. (45 cm)
 Angle of view 63°
 Weight 14 ozs. (398 gr.)

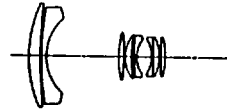
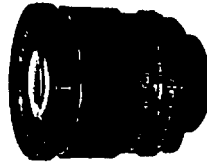

Super-Takumar 35mm f/3.5

A medium speed lens with extremely high resolving power, this is an excellent general purpose wide-angle optic extremely useful for scenic, industrial, and architectural photography. Compact and light in weight.

Lens element 5
 Minimum aperture f/16
 Minimum distance 1.5 ft. (45 cm)
 Angle of view 63°
 Weight 5.4 ozs. (152 gr.)

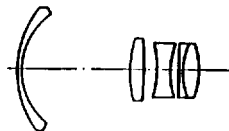

Super-Takumar 55mm f/1.8



Newest high-speed 6-element lens, utilizing latest optical glass advances. High resolving power combines with outstanding brightness for easiest focusing. An ideal all-around lens. Equipped with fully-automatic diaphragm.

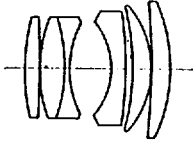

Lens element	6
Minimum aperture	f/16
Minimum distance	1.5 ft. (45 cm)
Angle of view	43°
Weight	7.6 ozs. (215 gr.)

Super-Takumar 55mm f/2

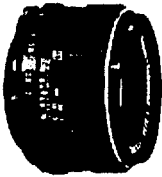

Razor-sharp, fully corrected, high-speed standard lens, using rare-earth glass, designed by top lens designers. Bright f/2 aperture makes viewing and focusing extremely easy. Its extremely fine resolving power is widely acclaimed by professionals and discriminating amateurs alike. Equipped with fully automatic diaphragm.

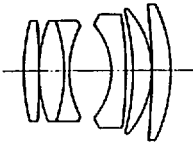

Lens element	6
Minimum aperture	f/16
Minimum distance	1.5 ft. (45 cm)
Angle of view	43°
Weight	7.6 ozs. (215 gr.)

Super-Takumar 85mm f/1.9

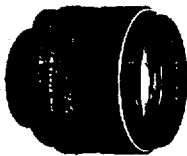

A new, ultra-fast 5-element lens which produces an image slightly larger than the standard lens. Perfect for available light portraiture, nature studies, and sports coverage. Used as a standard, general purpose lens by many photographers. Equipped with fully automatic diaphragm; supplied with special lenshood.

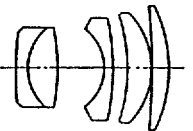

Lens element	5
Minimum aperture	f/16
Minimum distance	2.75 ft. (85 cm)
Angle of view	28°
Weight	12.3 ozs. (350 gr.)

Super-Takumar 105mm f/2.8

A quality medium telephoto lens of 5 elements, with well corrected aberrations. Light-weight design for portability and easy handling. Recommended for scenery, portrait, news photos, other moderate telephoto effects. Equipped with fully automatic diaphragm; supplied with special lenshood.

Lens element 5
 Minimum aperture f/22
 Minimum distance 4 ft. (1.2 m)
 Angle of view 23'
 Weight 10.2 ozs. (290 gr.)

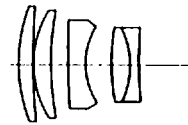

Takumar 105mm f/2.8

Exactly the same as the Super-Takumar 105mm; except it is equipped with a pre-set diaphragm. The pre-set diaphragm ring (1) is set at a desired aperture before focusing. Turn the actual diaphragm ring 2 to f/2.8 to focus with the diaphragm fully open. After accurate focusing has been achieved, turn the diaphragm ring (2) which automatically stops at the preselected aperture setting. Supplied with special lenshood.



Super-Takumar 135mm f/3.5

Produces a brilliant image in all corners of the picture even with the diaphragm fully open. Indispensable for distant subject matter and for portrait. Ideal for close-ups of animals or plants even at a distance. Recommended as the ideal long telephoto lens for handheld camera operation. Equipped with fully automatic diaphragm; supplied with special lenshood.

Lens element 5
 Minimum aperture f/22
 Minimum distance 5 ft. (1.5 m)
 Angle of view 18°
 Weight 12.1 ozs. (343 gr.)

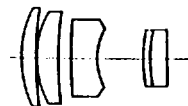

Super-Takumar 150mm f/4

This new fully automatic 150mm Super-Takumar with a focal length three times as long as the standard lens has been designed and produced to suit the purpose of photographing subjects requiring an intermediate angle between the 135mm and 200mm lenses. So compact, so light-weight, it looks like a 135mm lens, yet it is only 7mm longer. New-type, all-purpose telephoto lens ... for telephoto snaps, sceneries, sports, news events, stage photographs, nature life, etc.

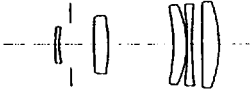

Lens element 5
 Minimum aperture f/22
 Minimum distance 6 ft. (1.8 m)
 Angle of view 16.5°
 Weight 11.3 ozs. (324 gr.)

Takumar 200mm f/5.6

Small, compact and light weight ... that's the new Takumar 200mm f/5.6 lens. It weighs only slightly more than Super-Takumar 135mm. Still it produces professional quality resolution in hand-held tele-photography. Equipped with pre-set diaphragm; supplied with special lenshood.

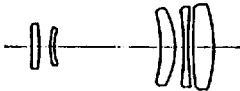

Lens element 5
 Minimum aperture f/22
 Minimum distance 9 ft. (2.5 m)
 Angle of view 12°
 Weight 13.1 ozs. (370 gr.)

Takumar 200mm f/3.5

A bright 4-element telephoto lens for hand-held shooting. New optical glass used with recently advanced theory of design. Ideal for extraordinary snapshots, stage, sports and news photos with exceptionally fascinating telephotographic effects. Equipped with pre-set diaphragm; supplied with special lenshood.

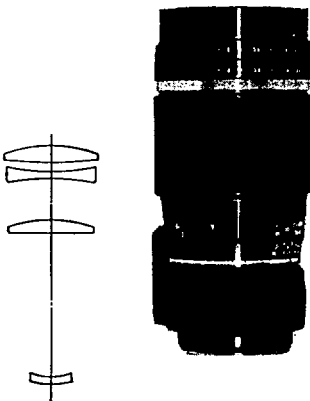

Lens element 4
 Minimum aperture f/22
 Minimum distance 9 ft. (2.5 m)
 Angle of view 12°
 Weight 26.5 ozs. (900 gr.)

Takumar 300mm f/4

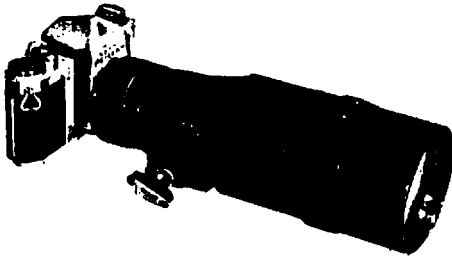

Light enough for hand-held picture taking, this lens is considered to be the most ideal for spectacular telephotographic effects. Even with the diaphragm fully open, the aberrations are corrected to the greatest extent possible. Gives needle-sharp resolution to every corner of the picture. Equipped with manual diaphragm; supplied with special lenshood.

Lens element	4	Angle of view	8°
Minimum aperture	f/32	Weight	55.6 ozs. (1.58 kg.)
Minimum distance	18 ft. (5.5 m)		

Tele-Takumar 300mm f/6.3

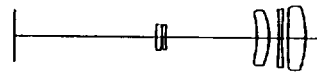
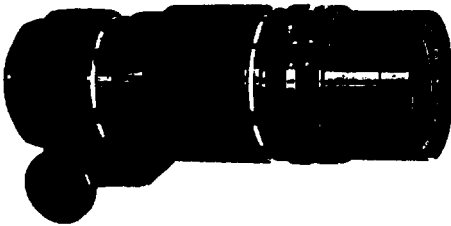

More compact and much lighter than the f/4, this lens is extremely suitable for handheld outdoor telephotography. Features smooth helicoidal focusing and built-in lenshood. Also represents an exceptional value in long-focus lenses and is the choice of many professionals and advanced amateurs who require an extremely versatile telephoto lens. Equipped with manual diaphragm.

Lens element	5	Angle of view	8°
Minimum aperture	f/22	Weight	25.7 ozs. (729 gr.)
Minimum distance	18 ft. (5.5 m)		

Tele-Takumar 400mm f/5.6

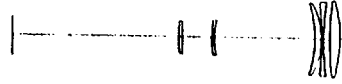

Especially designed for those professionals who specialize in outdoor sports, news and nature-life photography. Because of its $f/5.6$ aperture, this tele-lens is extremely compact and light for its focal length of 400mm. Also because of its portability, it can be easily handheld for fast and successive shooting, depending upon the shutter speed to be used. Equipped with click-stop manual diaphragm; supplied with special lenshood.

Lens element	5	Angle of view	6°
Minimum aperture	$f/45$	Weight	45 ozs. (1300 gr.)
Minimum distance	27 ft. (8 m)		

Takumar 500mm f/4.5

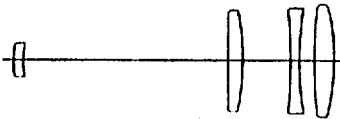

Comparatively light and small for its performance, this powerful long-focus lens brings the inaccessible within reach. Its bright $f/4.5$ image simplifies composition and focusing, and it produces edge-to-edge coverage of high resolution. Equipped with manual diaphragm; supplied with special lenshood.

Lens element	4	Angle of view	5°
Minimum aperture	$f/45$	Weight	122.5 ozs. (3500 gr.)
Minimum distance	32.8 ft. (10 m)		

Tele-Takumar 1000mm f/8

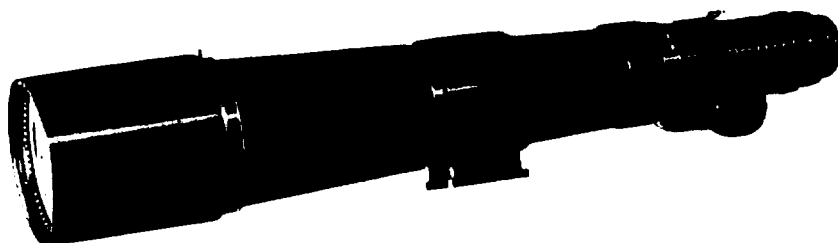

Photographs subjects which are too far away to be seen by the naked eye. The ultimate in fine optics for the photographer who specializes in news, sports, scientific or wildlife photography. Fast, accurate focusing with manual diaphragm. Furnished with built-on lenshood, rigid metal tripod and in wooden cases.

Lens element	5	Angle of view	2.5°
Minimum aperture	f/45	Weight of lens	197.5 oza. (5.5 kg.)
Minimum distance	98 ft. (30 m)	Weight of tripod	26 lbs. (11.8 kg.)

RESOLVING POWER OF TAKUMAR LENSES

Resolving power of all Takumar lenses is factory-tested by skilled optical engineers. There are three types of tests: microscopic aerial test, projection test and photographed film test. Resolving power of a lens shown by lpm (lines per mm) varies depending upon the method of resolution test. Takumar lenses have been tested for resolving power to conform to Asahi Optical Company standards which are higher than those set by JIS (Japan Industrial Standards). All Takumar lenses bear the seal of the Japan Camera Inspection Institute which insures the highest standards of performance.

When testing your lens performance...

Use a slow-speed fine grain film. Generally, high speed films are grainy and are not suitable for resolution test. Support your camera on a good tripod. Use a shutter release cable to prevent camera movement. The definition of the picture on the negative film may decrease if exposure and developing time are not proper. Time your exposure and development correctly.

If you do your own developing and enlarging, see that your enlarger uses a fine quality enlarger lens. If it is not of a fine quality, your pictures can never be sharp no matter what superb lenses are mounted on your camera. Usually, the diaphragm of the enlarger should be closed down to f/8 or f/11.

Takumar Fish-Eye 18mm f/11

The widest wide-angle lens—lighter and more compact than any made—covers an angle of vision of about 180°.

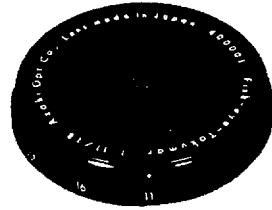
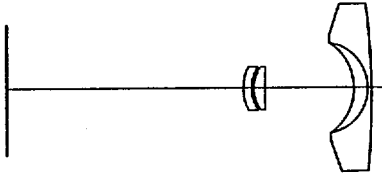

Macro-Takumar 50mm f/4

For photography from life-size to infinity without any close-up accessory, especially designed for close-up and macrophotography.

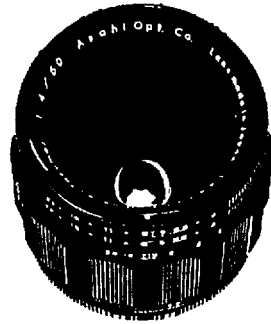

Bellows-Takumar 100mm f/4

Used with the standard Bellows Unit, this short-barrel lens enables you to photograph from life-size to infinity. Extremely convenient for close-ups from a distance.

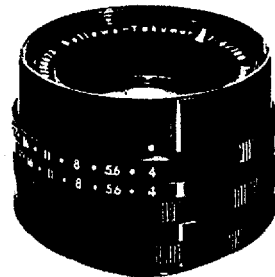
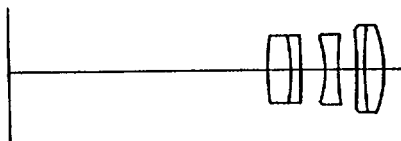

SPECIFICATIONS OF TAKUMAR LENSES

	NAME OF LENSES	FOCAL LENGTH & MAXIMUM APERTURE	MINIMUM APERTURE	LENS ELEMENT	DIAPHRAGM	MINIMUM FOCUSING DISTANCE		ANGLE OF VIEW	WEIGHT		FILTER SIZE	LENSHOOD SIZE	LENS CAP SIZE
						m.	ft.		degrees	gr.			
1	Takumar Fish-Eye	18mm f/11	32	4	M	—	—	180°	97	3.4	NA	NA	57
2	Super Takumar	28mm f/3.5	16	7	FA	0.4	1.3	75	260	9.2	58	60*	60
3	Super Takumar	35mm f/3.5	16	5	FA	0.45	1.5	63	152	5.4	49	49	51
4	Super Takumar	35mm f/2	16	8	FA	0.45	1.5	63	398	14	70†	70*	70
5	Super Takumar	50mm f/1.4‡	16	7	FA	0.45	1.5	46	230	8.1	49	49	51
6	Macro Takumar	50mm f/4	22	4	PS	—	—	46	265	9.3	49	49	51
7	Super Takumar	55mm f/2‡	16	6	FA	0.45	1.5	43	215	7.6	49	49	51
8	Super Takumar	55mm f/1.8†	16	6	FA	0.45	1.5	43	215	7.6	49	49	51
9	Quartz Takumar	85mm f/3.5	22	4	PS	—	—	28	126	4.4	49*	NA	51
10	Super Takumar	85mm f/1.9	16	5	FA	0.85	2.75	28	350	12.3	58	58*	60
11	Bellows Takumar	100mm f/4	22	5	PS	—	—	24	139	4.9	49	49	51
12	Takumar	105mm f/2.8	22	5	PS	1.2	4	23	250	8.8	49	49*	51
13	Super Takumar	105mm f/2.8	22	5	FA	1.2	4	23	290	10.2	49	49*	51
14	Super Takumar	135mm f/3.5	22	5	FA	1.5	5	18	343	12.1	49	49*	51
15	Super Takumar	150mm f/4	22	5	FA	1.8	6	16.5	324	11.3	49	49*	51
16	Super Takumar	200mm f/4	22	5	FA	2.5	8.2	12.5	550	19.3	58	58*	60
17	Tele Takumar	200mm f/5.6	22	5	PS	2.5	8.2	12	370	13.1	49	49*	51
18	Takumar	200mm f/3.5	22	4	PS	2.5	8.2	12	900	26.5	67	67*	70
19	Tele Takumar	300mm f/6.3	22	5	PS	5.5	18	8	729	25.7	58	58*	60
20	Takumar	300mm f/4	32	4	M	5.5	18	8	1575	55.6	82	82*	85
21	Tele Takumar	400mm f/5.6	45	5	M	8.0	27	6	1300	45	77	*	85
22	Takumar	500mm f/4.5	45	4	M	10.0	32.8	5	3500	122.5	49	*	127
23	Tele Takumar	1000mm f/8.7	45	5	M	30.0	98	2.5	5500	192.5	49	*	143
24	Super Takumar Zoom	70-150mm f/4.5	22	14	FA	3.5	11.5	16-35	1209	42.6	67	67*	70

NA = Not Available. M = Manual. FA = Fully Automatic. PS = Preset. (†) = Diagonal coverage.
 (‡) = Clip-on type. (③) = Standard lens for Spotmatic. (④) = Standard lens for model S1a. (⑤) = Standard lens for models SV & Spotmatic. (⑥) = Special filters are supplied with lens. (‡) = Supplied with wooden tripod and carrying cases. All lenses, including standard lenses purchased separately, are supplied with leather case, straps, front and rear caps. All filters and lenshoods are screw-in type unless otherwise indicated. (*Special lenshood supplied with these lenses.)

EXTENSION TUBES

By inserting any or all of the extension tubes between the camera body and the Takumar lens, subjects as close as $3\frac{35}{64}$ inches from the front of 55mm lens may be photographed. By adding more extension tubes, close-ups as close as the focal length of the lens may be easily and simply photographed.

The extension tube set consists of 3 rings. #1, #2 and #3; 9.5mm, 19.0mm and 28.5mm respectively. These rings may be used in combination as desired. Ring #1 is suited for moderate close-up work as in copying documents. When all extension tubes are used simultaneously with 55mm lens, the subject may be enlarged on the film to a magnification of 1.04 of the life size. Such extreme close-up photography is a special advantage of the single lens reflex camera because there is no parallax problem and you do not need an accessory viewfinder as is ordinarily required for rangefinder type cameras.

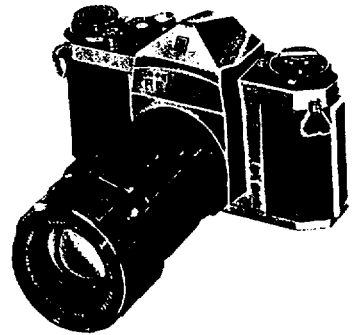

BELLOWS II

Double-track, De Luxe model bellows unit for extreme magnification. Mounted between your camera body and standard lens, you can obtain the maximum magnification of more than 3 times the life size. ↓

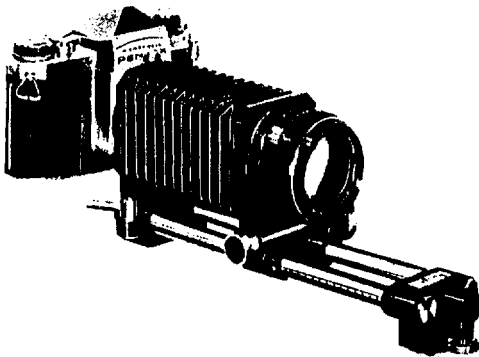

SLIDE COPIER

Use this with the Bellows II for duplicating your color slides. ↓



HONEYWELL REPRONAR

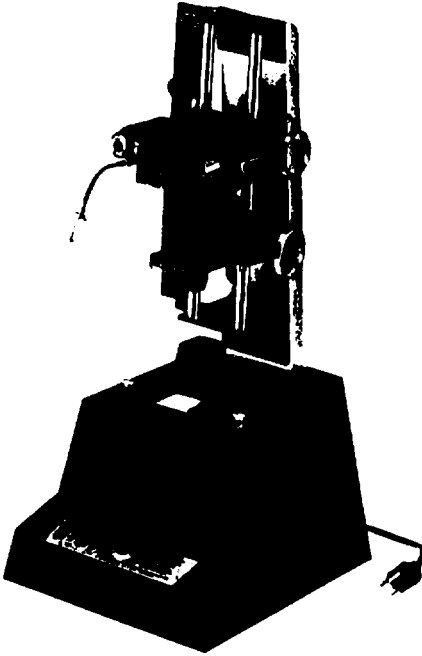

An extremely versatile accessory for the Honeywell Pentax owner who specializes in color transparencies, the Repronar incorporates a specially modified Honeywell Pentax camera with a precision $f/3.5$ copying lens and a Strobosnar electronic flash light source. It enables the user to duplicate original transparencies, correct for exposure errors and color balance, crop and enlarge portions of original transparencies, create special effects, and perform many other processes in color or black and white. Focusing and composition are quick and easy, and a built-in exposure scale takes the guesswork out of camera settings. Complete with filters, slide holders, lens cap and dust cover.

HONEYWELL PENTAX COPIPOD

This new portable copying stand fits all models of the Honeywell Pentax and can be used anywhere for copying documents, artwork, photographs, stamps, etc. The Copipod consists of a lens board complete with adapter rings for 46mm and 49mm sizes, and four calibrated telescoping legs. It can be set up in seconds, and when disassembled, fits neatly into a pouch-type case which occupies very little space. Lightweight, yet extremely rigid, the Copipod is a practical accessory which will fill a need for many Honeywell Pentax owners.

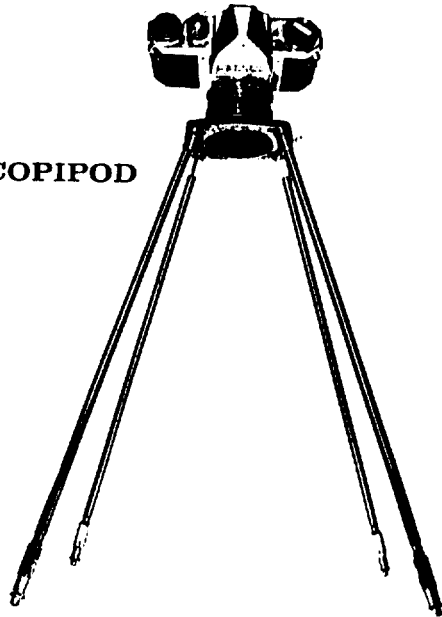

COPY STAND

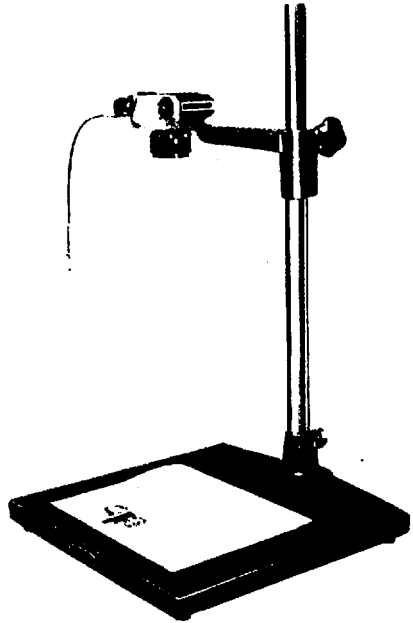

REVERSE ADAPTER

Screwed into the front thread of a Takumar lens which accepts 49mm-size filters and with the other end threaded into extension tubes or bellows mounted on an Honeywell Pentax, this adapter gives optimum performance in macrophotography of more than a life-size magnification.



MICROSCOPE ADAPTER

By inserting this adapter between the camera body and the microscope tube, photomicrography can be easily and simply accomplished with the optics of the microscope.

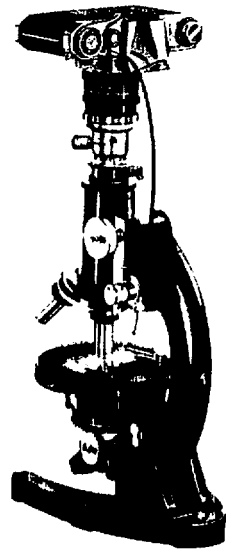

LEICA MOUNT ADAPTER

ADAPTER 'A' - For use of Leica-mount lenses on the Honeywell Pentax camera body. Leica-mount lenses may be used on the Honeywell Pentax camera body with this adapter ring *ONLY for close-up photography*. The following table illustrates the film plane-to-subject distance that can be covered by Leica-mount lenses when using this adapter.

ADAPTER 'B' - For use of Takumar lenses on Leica-mount camera bodies. Primarily for use with Leica lens mount enlargers.

Focal length of Leica mount lens	Film-to-subject distance		Size of area to be photographed	
50mm	10 ¹⁵ / ₆₄ in.	26cm	2 ⁶¹ / ₆₄ × 3 ¹⁵ / ₁₆ in.	6.7 × 10cm
85mm	22 ⁷ / ₁₆ in.	57cm	4 ¹¹ / ₆₄ × 6 ¹⁹ / ₆₄ in.	10.6 × 16cm
105mm	32 ⁹ / ₃₂ in.	83cm	5 ¹⁵ / ₆₄ × 7 ⁷ / ₈ in.	13.3 × 20cm
135mm	48 ⁵³ / ₆₄ in.	124cm	6 ¹¹ / ₁₆ × 10 ¹ / ₃₂ in.	17.0 × 25.5cm

(When lens is focused at infinity).



A



B

LENS MOUNT CAP

For use with all Takumar lenses. When your Takumar lens is not on the camera body, use this cap to avoid dust.

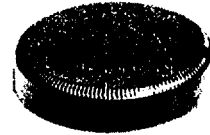

BODY CAP

Use this body mount cap when you do not have a lens on your camera body.



LENS LEATHER CASE

for standard lenses



When using an accessory lens on your camera body, put your standard lens in this leather case for protection.

FILM MAGAZINE

For use in loading bulk film.

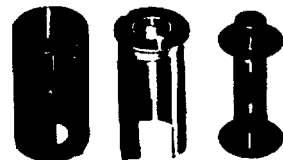

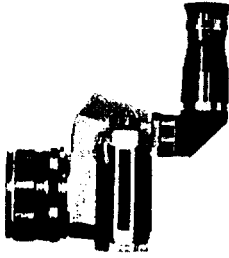

90° FINDER

A convenient accessory viewfinder to be attached to the viewfinder frame of the Honeywell Pentax, for low-angle close-up, photo-micrography, etc.

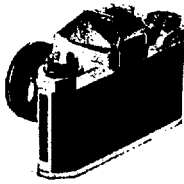

ACCESSORY CLIP

Attaches to the Honeywell Pentax viewfinder window for mounting a folding flash gun, etc.

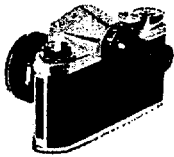

MAGNIFIER

2-power magnification. Most convenient for critical focusing in close-ups, macro-photography, copying works, etc.



CABLE RELEASE

Use a cable release to prevent camera movement.



CLOSE-UP LENS

For simple close-ups, this is an extremely versatile and economical accessory, and enables you to close up your objects as large as 1/3 the life size with your standard lens. It also fits Takumar and Super-Takumar 105mm 1/2.8, 135mm 1/3.5 and Tele-Takumar 200mm 1/5.6 lenses. With this lens on a Super Takumar lens, you can operate the diaphragm fully automatically, without manipulation for exposure increase.



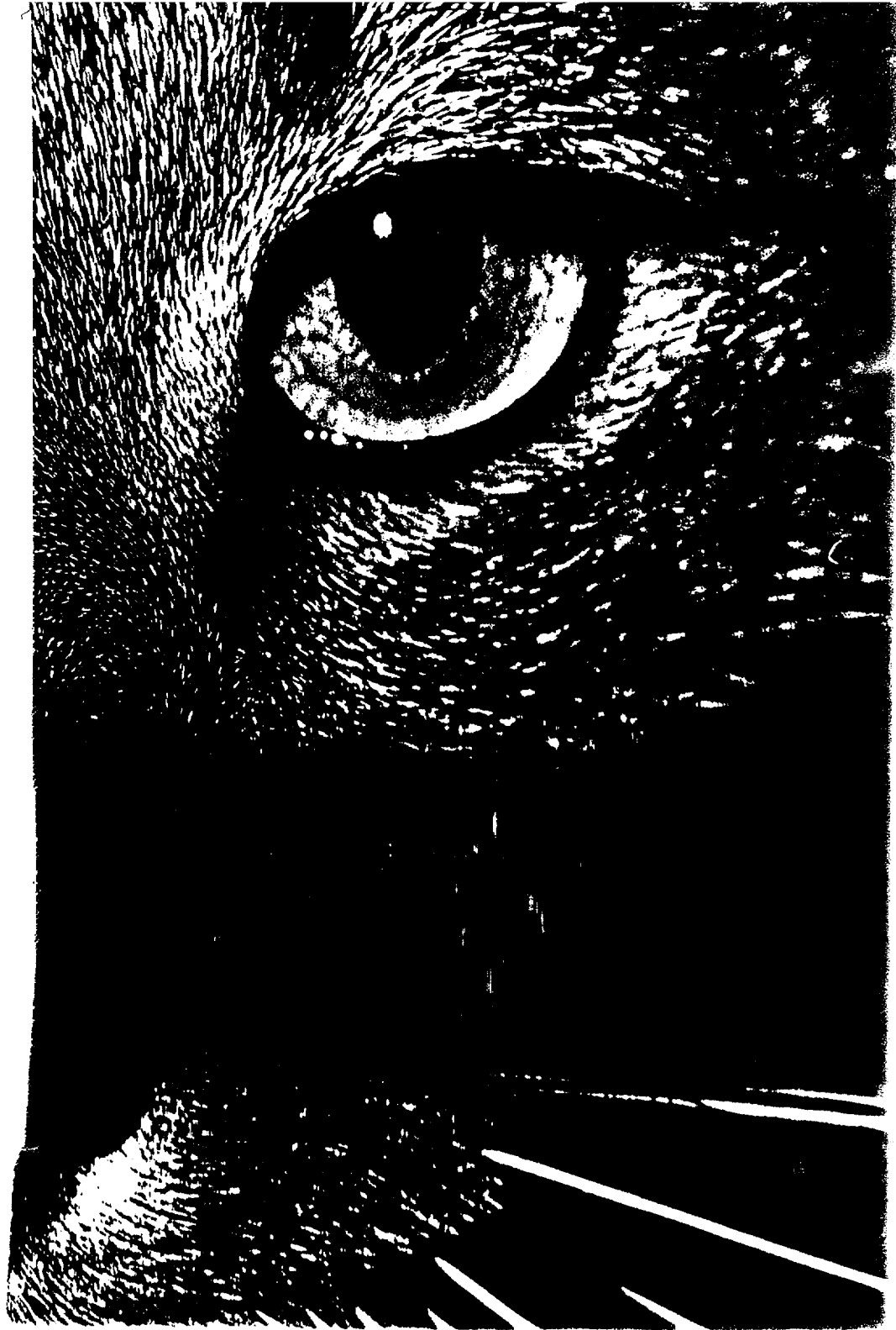

ASA-DIN FILM SPEED CONVERSION TABLE

ASA	DIN	Relative Exposure Needed
800	30°	1
640	29°	1.3
500	28°	1.6
400	27°	2
320	26°	2.5
250	25°	3.2
200	24°	4
160	23°	5
125	22°	6.3
100	21°	8
80	20°	10
64	19°	13
50	18°	16
40	17°	20
32	16°	25
25	15°	32
20	14°	40
16	13°	50
12	12°	63
10	11°	80
8	10°	100
6	9°	125
5	8°	160
4	7°	200
3	6°	250
2.5	5°	320
2	4°	400

ASA = American Standards Association
 DIN = Deutsche Industrie Normen

FEET-METER CONVERSION TABLE

Feet/Inches to metric units		Metric units to feet/inches	
1/8 in.	0.32 cm.	0.5 cm.	3/16 in.
1/4 in.	0.64 cm.	1 cm.	3/8 in.
3/8 in.	1.27 cm.	2 cm.	13/16 in.
1 in.	2.54 cm.	3 cm.	1 1/16 in.
2 in.	5.08 cm.	4 cm.	1 1/8 in.
3 in.	7.62 cm.	5 cm.	1 1/4 in.
4 in.	10.2 cm.	6 cm.	2 1/8 in.
5 in.	12.7 cm.	7 cm.	2 3/8 in.
6 in.	15.2 cm.	8 cm.	3 1/8 in.
7 in.	17.8 cm.	9 cm.	3 3/8 in.
8 in.	20.3 cm.	10 cm.	3 1/2 in.
9 in.	22.9 cm.	12 cm.	4 3/8 in.
10 in.	25.4 cm.	15 cm.	5 3/8 in.
11 in.	27.9 cm.	20 cm.	7 3/8 in.
1 ft.	30.5 cm.	25 cm.	9 1/8 in.
2 ft.	61.0 cm.	30 cm.	11 3/8 in.
3 ft.	91.4 cm.	40 cm.	15 3/8 in.
4 ft.	1.22 m.	50 cm.	19 3/8 in.
5 ft.	1.52 m.	60 cm.	23 3/8 in.
6 ft.	1.83 m.	80 cm.	31 3/8 in.
7 ft.	2.13 m.	100 cm.	39 3/8 in.
8 ft.	2.44 m.	1.5 m.	4 ft. 11 in.
9 ft.	2.74 m.	2 m.	6 ft. 7 in.
10 ft.	3.05 m.	2.5 m.	8 ft. 3 in.
15 ft.	4.57 m.	3 m.	9 ft. 10 in.
20 ft.	6.10 m.	4 m.	13 ft. 2 in.
30 ft.	9.14 m.	5 m.	16 ft. 5 in.
40 ft.	12.20 m.	10 m.	33 ft. 0 in.
50 ft.	15.24 m.	15 m.	49 ft. 2 in.
100 ft.	30.48 m.	20 m.	66 ft. 0 in.



ARRANTY POLICY

Honeywell Pentax camera equipment and accessories sold in the United States and Mexico are unconditionally guaranteed against defects of material or workmanship for a period of twelve months from date of purchase. Service will be rendered and defective parts will be replaced without cost to you within that period, provided the equipment has not been abused, altered, or operated contrary to instructions. Honeywell shall not be liable for any repair or alterations except those made with its written consent and shall not be liable for damages from delay or loss of use or from other indirect or consequential damages of any kind, whether caused by defective material or workmanship or otherwise; and it is expressly agreed that Honeywell's liability under all guarantees or warranties, whether expressed or implied, is strictly limited to the replacement of parts as hereinbefore provided. In order to validate your warranty, the warranty card must be filled in COMPLETELY and mailed to the factory within ten days of purchase.

PROCEDURE DURING 12-MONTH WARRANTY PERIOD.

Any equipment which proves defective during the 12-month warranty period should be returned to your Honeywell Pentax dealer. The dealer will forward the equipment to the Honeywell factory or nearest Honeywell repair station. If the equipment is covered by warranty (as evidenced by its registration in Honeywell's files) repairs will be made and parts replaced free of charge, and the equipment returned prepaid to your dealer. If the equipment is not covered by warranty, Honeywell's regular charges will apply.

All models, prices and specifications are subject to change without notice.



Honeywell

PHOTOGRAPHIC

4800 East Dry Creek Road, Denver, Colorado 80217

