

**ASAHI
PENTAX**

KM

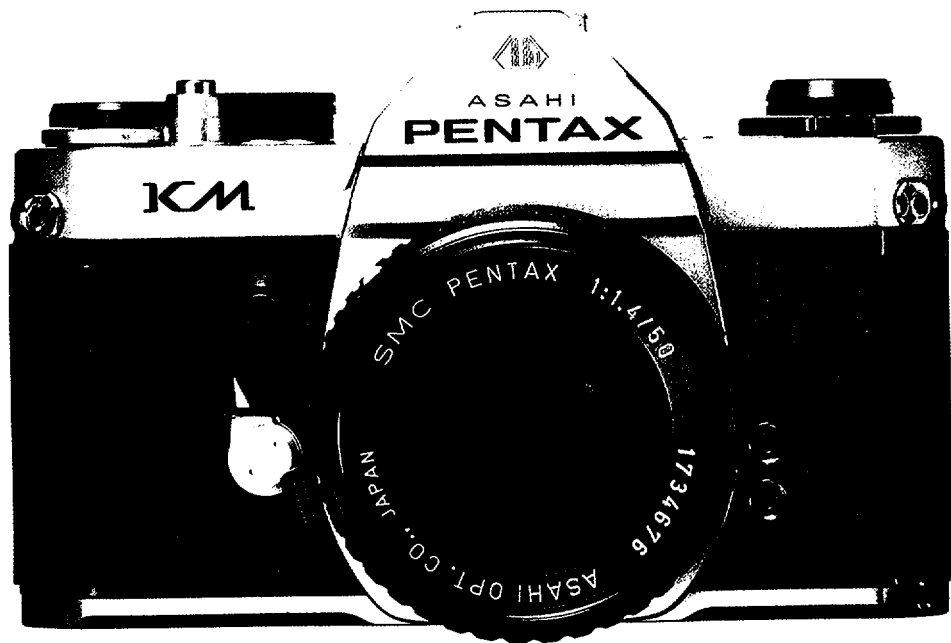

INDEX

Nomenclature	1
Specifications	4
●	
Lens Mounting	6
Battery	7
Basic Operating Instructions	8
Film Loading and Winding	10
Film Reminder Dial	11
Setting ASA Film Speed	12
Compose and Focus	13
Shutter	14
Camera Holding	15
Film Unloading	16
●	
Self-timer	17
Flash Synchronization	18
Depth-of-field Preview Button and Guide	20
Helpful Hints on Exposure Problems	22
Manual Shutter Operation	23
Infra-red Photography	24
Multiple Exposure	25
Range of Light Measurement	26
Open-aperture or Stop-down Metering	27
Using Conventional Screw-mount Takumar Lenses ...	28
Resistance to Temperature Extremes and Changes ...	31
●	
Camera Maintenance	32
Warranty Policy	34

SMC Pentax lenses and Pentax accessories are engineered and produced meticulously to precise Asahi Pentax specifications. Lenses and accessories from other manufacturers are not produced to these precise specifications and, therefore, may cause difficulties with — or actual damage to — a Pentax camera. Asahi Pentax cannot assume any responsibility or liability for difficulties resulting from the use of any other brand of lenses or accessories with an Asahi Pentax camera.

NOMENCLATURE

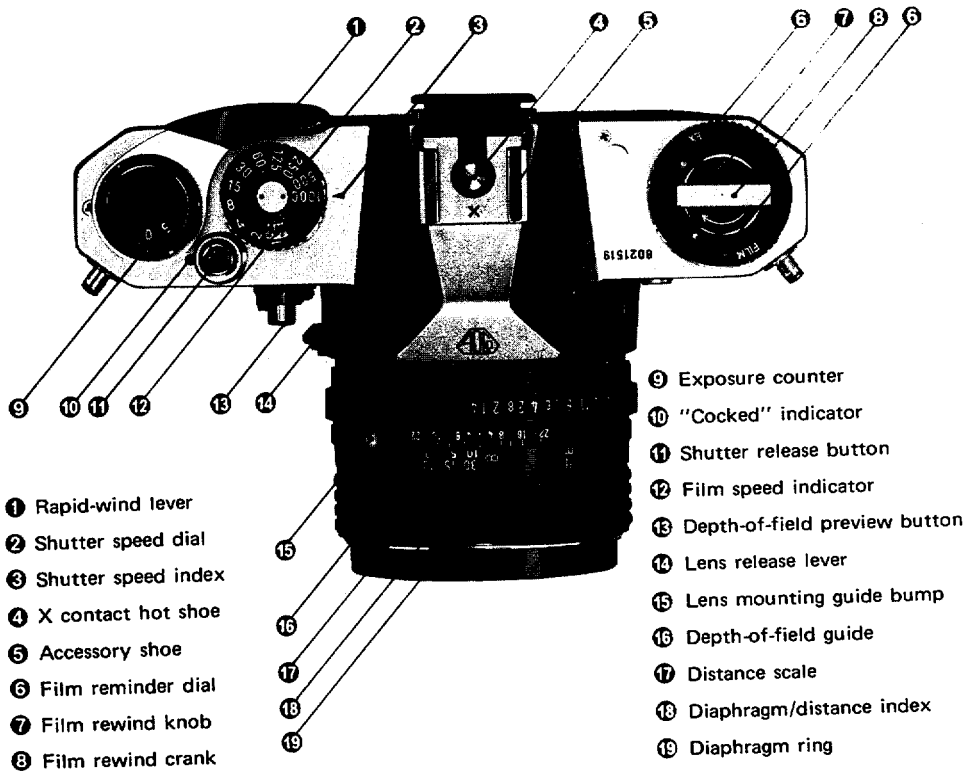

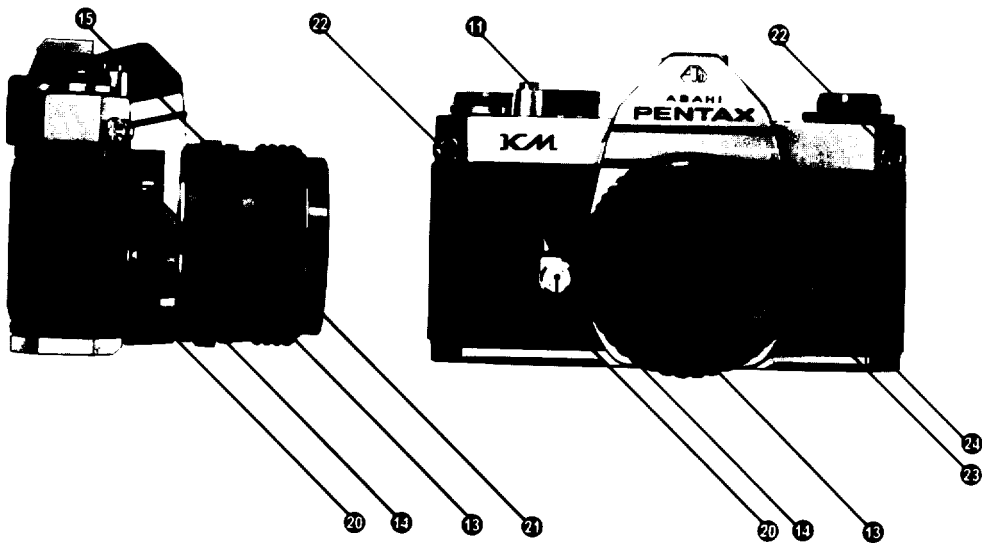

- ⑳ Self-timer
(Start lever underneath)
- ㉑ Focusing ring
- ㉒ Strap ring lug
- ㉓ X flash terminal
- ㉔ FP flash terminal
- ㉕ Accessory fitting groove

- ㉖ Film guide rail
- ㉗ Film rail
- ㉘ Viewfinder eyepiece
- ㉙ Film chamber
- ㉚ Battery chamber
- ㉛ Tripod receptacle
- ㉜ Shutter curtains

- ㉝ Film rewind button
- ㉞ Sprocket
- ㉟ Film take-up spool
- ㊱ Film roller
- ㊲ Back cover
- ㊳ Film pressure plate

ASAHI
PENTAX **KM**

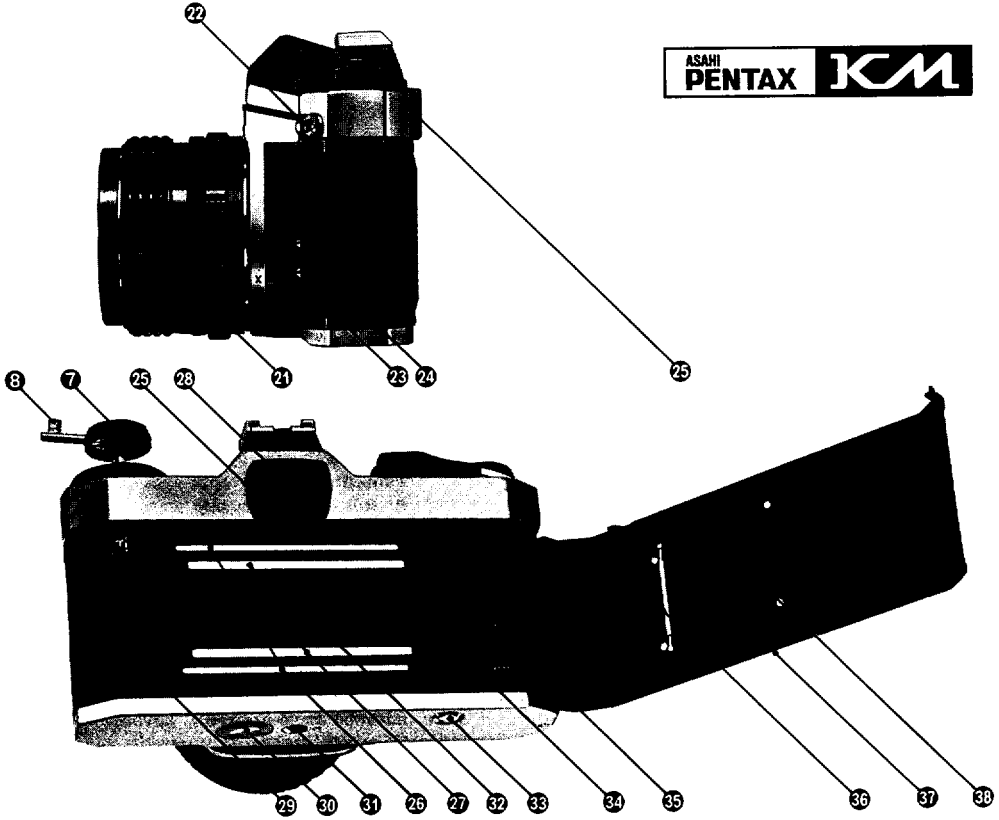

SPECIFICATIONS

Type	35mm SLR with built-in through-the-lens light meter.
Film and Picture Size	35mm film. 24mm x 36mm.
Standard Lenses	SMC Pentax 50mm f/1.2, 50mm f/1.4 and 55mm f/1.8 with fully-automatic diaphragm. Filter size: 52mm. Focusing: 0.45m (1.5 ft.) to infinity.
Shutter	Horizontal run, focal-plane shutter of rubberized silk curtains. Speeds: B, 1 to 1/1000 sec.
Self-timer	Built-in self-timer with interrupt function. Releases shutter in 5 – 13 sec.
Viewfinder	Pentaprism finder with cross-microprism or split-image focusing screen. 0.87x magnification with 50mm lenses (life-size with 55mm lens). Dioptry –1.0.
Focusing	Microprism and split-image screens standard plus custom screens.
Reflex Mirror	Instant-return type with special shock absorbers for minimum vibration.
Lens Mount	Pentax bayonet mount.
Film Advance	Ratchet-type rapid-wind lever. 10° pre-advance angle and 160° advance angle. "Cocked" indicator alongside shutter release button.
Exposure Counter	Automatic re-set.

Film Rewind	Rapid-rewind crank for speedy film take-up.
Flash Synchronization	X contact hot shoe for cordless flash connection. FP + X contacts for conventional flash cord connection. X synchronization at 1/60 sec.
Exposure Meter	CdS meter measures the average brightness of the ground glass at full aperture, and couples directly to aperture, shutter and film speed settings. Center needle for correct exposures. Film speed from 20 to 3200 ASA. EV 3 – 18 for ASA 100 film with 50mm lens. Powered with one 1.5V silver oxide battery. Meter on-off by extra CdS cell in body.
Loaded Film Indicator	Reminder dial below film rewind knob, with settings for 20 or 36 (exposures), for ☼ daylight or ⦿ tungsten color, or ◻ black and white film.
Dimensions	With 50mm f/1.4 lens: width 143mm (5.6") x height 91.4mm (3.6") x depth 94mm (3.7").
Weight	887g (31 ozs.) with 50mm f/1.4 lens. 622g (21.8 ozs.) with no lens.

LENS MOUNTING

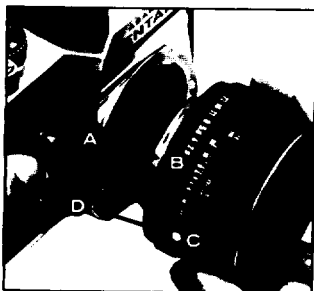

1. Remove the rear lens and body caps.
2. Match the red dot **A** on the camera body with the red dot **B** on the lens. Insert the lens into the body and turn it clockwise until the lens locks with a click.
3. In the dark, when the red dots are difficult to see, align the white plastic bump **C** on the lens barrel with the lens release lever **D** by touch. Then turn and lock as above.

4. To detach, hold the camera with your left hand. Depress the lens release lever **D** while turning the lens counter-clockwise with your right hand.

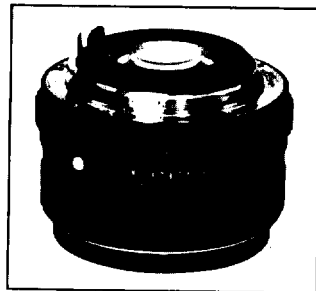

CAUTION

If you have to put the lens down without the rear lens cap, place it only on its front end, never on the rear.

When changing lenses outdoors with film in the camera, avoid direct sunlight.

BATTERY

A silver oxide battery is packed separately. Be sure to insert it into the battery chamber before operating the camera.

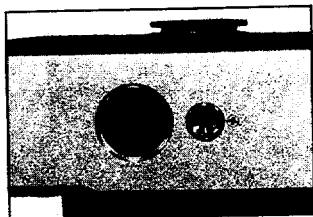

BATTERY INSERTION

Open the battery chamber cover with a coin. Insert the battery with (+) side facing out. For replacement, use Eveready S76E or Mallory MS76H or equivalent.

The battery is like a phonograph record. It can be damaged by skin acids. Handle by the edges with a dry cloth only. Be sure the battery is cleaned with the cloth before insertion into the camera. The battery is not rechargeable. Do not throw a dead battery into fire, as it may explode.

Also, keep it beyond the reach of small children. When not actually measuring the light, be sure that the lens is covered at all times. Leaving the lens cap off for an extended period will exhaust the battery.

BATTERY CHECK

Set the shutter speed dial to B (bulb) position.

Turn the ASA dial to ASA 100.

Look at the meter needle through the viewfinder. If the needle is in "up" position and remains steady, the battery is good: if it does not, replace the battery. Check the battery frequently. And take spares with you when traveling.

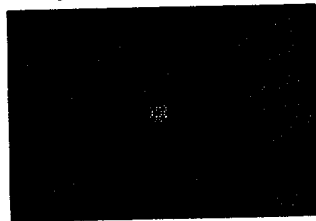

BASIC OPERATING INSTRUCTIONS



1. TURN ON LIGHT METER

Remove the lens cap and the meter circuit is on. The CdS cells measure the light coming through the lens for correct exposure.

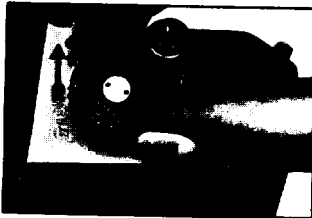

2. SET FILM SPEED

Lift the outer ring of the shutter speed dial and turn it until the same number as the ASA number of the film you're using appears next to the small orange index alongside the figure 1.

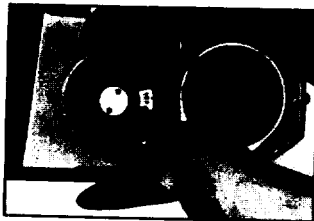

3. SET SHUTTER SPEED

Turn the shutter speed dial and set the speed you wish to use to the index. Generally, you should use the fastest possible shutter speed to avoid blurred pictures caused by camera movement. Try starting with 1/125 sec. outdoors in daylight and 1/60 sec. indoors.

4. COMPOSE AND FOCUS

While viewing through the viewfinder, turn the focusing ring until your subject comes into sharp focus.

5. ROTATE DIAPHRAGM RING

The needle moves as you turn the diaphragm ring. When the needle on the right side of the viewfinder image is at the center, you will get correct exposure. If the needle does not come to the center no matter how far you turn the diaphragm ring, change the shutter speed. When the needle is close to the (+) mark, you will get an over-exposure; change the shutter speed to a faster setting. If the needle is closer to the (-) mark, you will get an under-exposure; change the shutter speed to a slower setting.

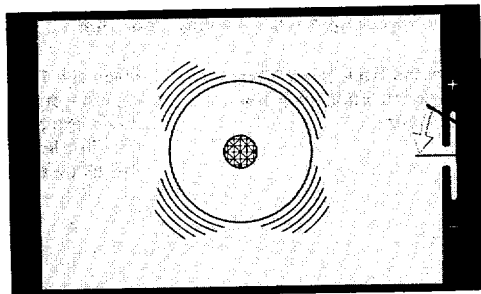

6. RELEASE SHUTTER

Cock the rapid-wind lever. Hold your camera firmly and trip the shutter. Then cock the rapid-wind lever for the next picture. (When taking a series of pictures under the same lighting conditions, it is not necessary to repeat instruction 5.)



FILM LOADING AND WINDING



Avoid direct light when loading your film.

1.
Open the back by pulling up the rewind knob until the back opens.



2.
Place the film cassette in the cassette chamber, and push down the rewind knob. Insert the film leader into the slot of the take-up spool.

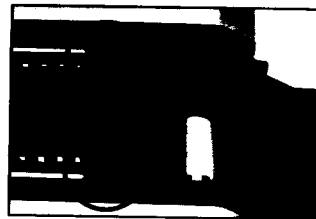

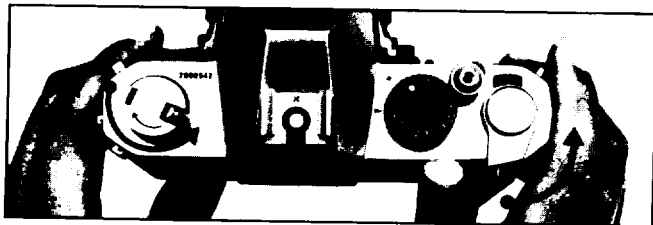

3.
Advance the film by alternately turning the rapid wind lever and depressing the shutter button until both sprockets engage the film perforations, top and bottom. Close the back by pressing it firmly.



4.
Cock the rapid-wind lever, and confirm that the film rewind knob turns counter-clockwise, indicating that the film is being properly loaded and is moving from cassette to take-up spool. Trip the shutter. Advance the film until the exposure counter turns to "1", indicating that the first picture is ready to be taken.

FILM REMINDER DIAL

Use the film type dial as a reminder of what type of film is in your camera. The dial is marked  for black-and-white,  for daylight color film,  for tungsten color film, 20 and 36 exposures. To set the dial, turn the outer ring so that both the type of film and its number of exposures appear in the windows. To check whether the camera is loaded, turn the film rewind knob clockwise. If it turns freely, the camera is not loaded.

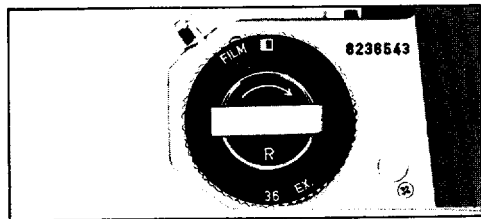

SETTING ASA FILM SPEED

The ASA film speed rating of all 35mm films is given in the data sheet packed with each roll of film. The higher the ASA number, the more sensitive the film is to light. Lift the outer ring of the shutter speed dial and rotate it until the ASA number of your film is opposite the orange dot alongside the figure 1.

Be sure to set your film speed on the shutter speed dial because the dial is connected to the exposure meter.

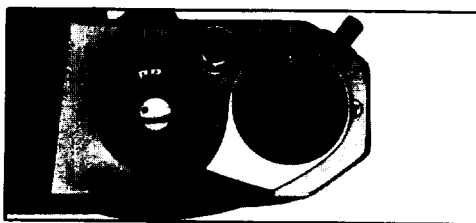
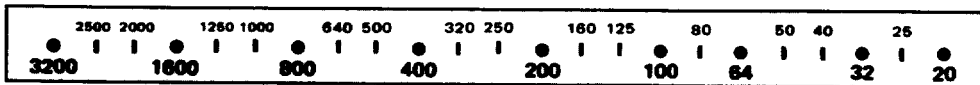

COMPOSE AND FOCUS

While viewing through the viewfinder, turn the focusing ring until your subject comes into sharp focus. Depending on the type of focusing screen you have, there are two ways of doing this.

Cross-microprism focusing system

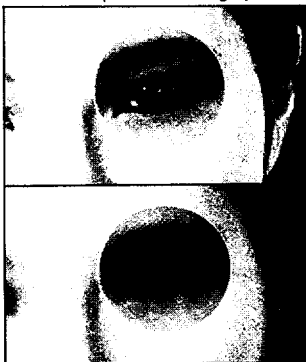

A cross-microprism focusing system consists of a Fresnel lens, made up of many concentric rings, with a microprism center underneath the ground glass. With this system, when your subject is in focus, the image in the microprism center will be sharp. If your subject is not in focus, the microprism will break the image up into many small dots.

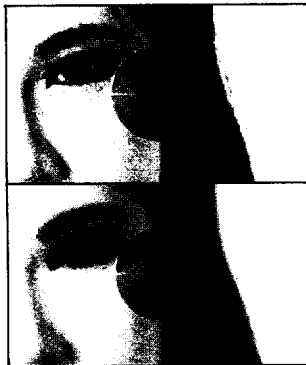

Split-image focusing system

A split-image focusing system consists of a Fresnel lens with a horizontally divided screen under the ground glass. With this system, when your camera is held horizontally and the image is not in sharp focus, all vertical lines seen through the viewfinder will appear to be divided into upper and lower portions. To focus, simply adjust the focusing ring until the upper and lower portions are in perfect alignment.

SHUTTER

Turn the shutter speed dial clockwise or counter-clockwise to the shutter speed desired. The shutter speed can be set either before or after cocking the rapid-wind lever. As you cock the shutter by turning the rapid-wind lever, the "cocked" indicator turns to red showing that the shutter is cocked. For use of the X setting (next to the 60) on the shutter speed dial, refer to page 19. With the shutter speed dial set on B (bulb), the shutter will stay open as long as you keep the shutter button depressed. As you release your finger from the shutter button, the shutter closes. For particularly long exposures ("time exposure"), use a cable release with a locking device.

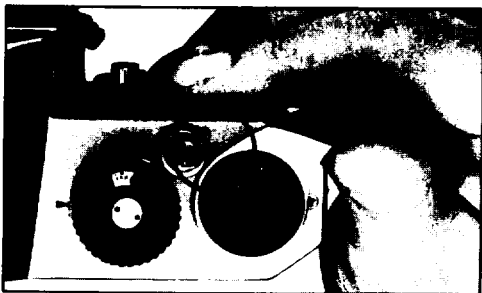

CAUTION

At slow speeds -- slower than 1/30 -- support your camera rigidly or use a tripod to prevent camera movement. To protect the shutter mechanism, trip the shutter release before putting the camera away for any extended period.

CAMERA HOLDING

As a general rule, your camera should be held more firmly in the left hand, which does not release the shutter. If you hold your camera with the right hand — the hand that releases the shutter — it may cause camera movement. Often, blurred pictures are due to camera movement.

Horizontal position A.

Hold the camera firmly with your left hand, and draw your arms close to your body.



Vertical position B.

Hold your camera tightly to your forehead with your left hand, and draw your right arm close to your body.



Vertical position C.

Hold your camera tightly to your forehead with your left hand, raise your right arm and draw your left arm to your body.



FILM UNLOADING

After the final picture on the roll has been taken, the rapid-wind lever will not turn (Caution: do not try to force the lever), indicating that the film must be rewound. Lift the rewind crank up. Depress the film rewind release button and turn the rewind crank as indicated to rewind the film into its cassette. Rewind until the tension on the crank lessens, indicating that the leader end of the film has been released from the take-up spool. Pull out the film rewind knob (the back will open automatically), and remove the film cassette.

AVOID DIRECT LIGHT WHEN UNLOADING THE FILM.

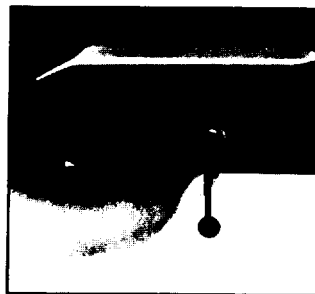
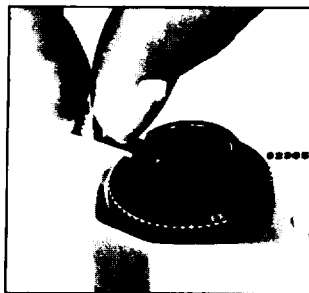

SELF-TIMER

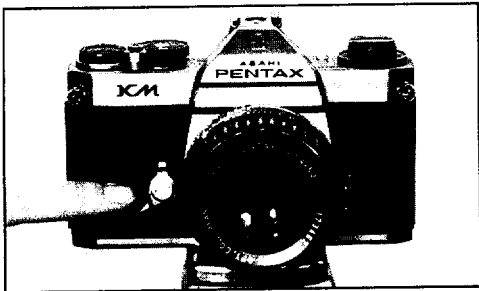

The self-timer delays shutter release between 5 and 13 seconds, depending upon how far counter-clockwise you have turned the cocking lever. **When using the self-timer, do not depress the shutter release button . . . it will immediately release the shutter without delayed action.**

Turn the cocking lever down 90° – 180° . Move the small light-colored self-timer start lever as indicated . . . the self-timer will start.

This self-timer also has an interrupt function. Even after the self-timer has started to run, you can stop it by moving the start lever back to normal position, as long as the cocking lever has not been moved back past the 90° position. You can re-start the self-timer by pushing the cocking lever down again and moving the start lever again.

Do not leave the cocking lever in "interrupt" position for an extended period, as this may weaken the spring.

FLASH SYNCHRONIZATION

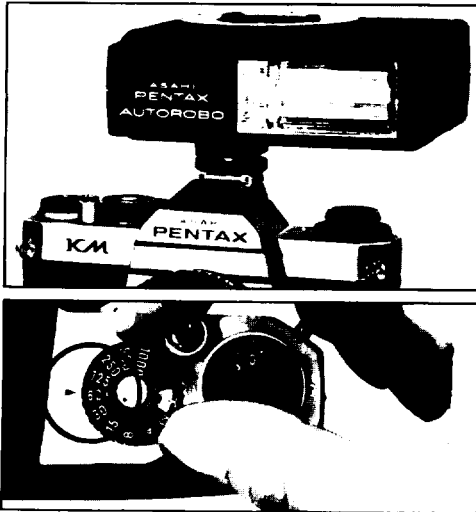

The KM has FP and X terminals on the front of the camera body, and a separate X contact on the built-in hot shoe. The table on the next page shows which flash contact, which shutter speed and which flash bulb may be combined for maximum lamp efficiency. Unless these combinations are rigidly followed, there will be a failure in flash synchronization. Note the "X" setting is exactly at the 60 marked on the speed dial. This indicates the highest shutter speed at which electronic flash units may be used.

Use the hot shoe flash contact when using a shoe-mount electronic flash like the Pentax Autorobo which has a flash contact on the shoe bracket. When using the hot shoe, there is no need to plug the flash cord into the X terminal on the body front.

The hot shoe flash contact turns to "hot" (switched on) only when you insert a shoe-mount electronic flash. It remains "cold" (disconnected) even when using an electronic flash with its cord plugged into the X terminal on the body front. This eliminates the danger of electric shocks.

There are basically two types of flash bulb attachments on the market: clip-on types and bracket types. Either can be used with your camera. The clip-on types are attached to the hot shoe and the bracket types are screwed into the tripod screw hole.

Use one of these three bulb types: M, MF or FP. The correct terminal and the correct shutter speed to use for each of these three types are outlined in the table below.

Before attaching the flash unit to the camera, you must remove the protective plug from the proper terminal.

When not using the terminals, keep the plugs inserted.

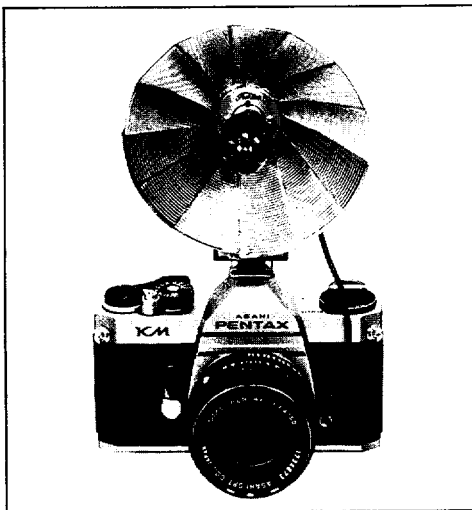

SHUTTER SPEED	$\frac{1}{1000}$	$\frac{1}{500}$	$\frac{1}{250}$	$\frac{1}{125}$	$\frac{1}{60}$	$\frac{1}{30}$	$\frac{1}{15}$	$\frac{1}{8}$	$\frac{1}{4}$	$\frac{1}{2}$	1	B
ELECTRONIC FLASH	X											
FLASH BULB	FP	FP CLASS										
	X	M · MF · FP CLASS										

DEPTH-OF-FIELD PREVIEW BUTTON AND GUIDE

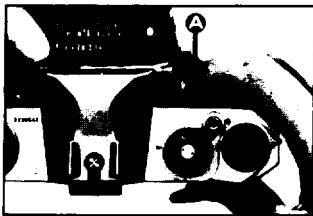

Depth of field is the range between the nearest and farthest distances which are in focus at a given lens aperture. If you want to know how great the depth of field is at a certain aperture, focus on a subject and see through the viewfinder while depressing the depth-of-field preview button **A**. Or, after focusing, look at the depth-of-field guide on the lens. In the photograph below, the distance scale is set at 5 meters . . . the lens is focused on a subject 5 meters away. The calibrations on each side of the distance index correspond to the diaphragm setting and indicate the range of in-focus distance for different lens apertures. For example, if a lens opening of $f/4$ is to be used, the range on the distance scale ring covered within the figure 4 on the depth-of-field guide indicates the area in focus at that lens opening. You will note from the depth-of-field guide in the photograph that the range from approximately 4 to 7 m is in focus. Note that as the lens apertures change, the effective depth of field also changes. For the depths of field at different apertures and distances, refer to the next page.

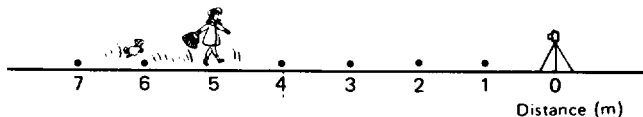
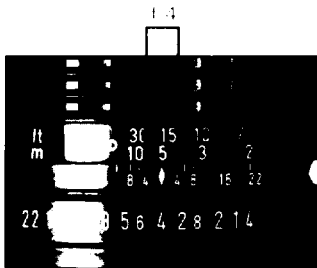

DEPTH-OF-FIELD TABLE: SMC PENTAX 50mm LENS

Distance scale	0.45m	0.6m	1m	1.5m	2m	5m	10m	∞
f/1.2	0.448 ~ 0.452	0.596 ~ 0.604	0.987 ~ 1.014	1.469 ~ 1.533	1.943 ~ 2.060	4.646 ~ 5.413	8.661 ~ 11.832	63.799 ~ ∞
(f/1.4)	0.447 ~ 0.453	0.595 ~ 0.605	0.984 ~ 1.016	1.463 ~ 1.538	1.934 ~ 2.071	4.591 ~ 5.489	8.472 ~ 12.205	54.691 ~ ∞
f/2	0.446 ~ 0.454	0.593 ~ 0.607	0.978 ~ 1.023	1.448 ~ 1.556	1.907 ~ 2.103	4.436 ~ 5.730	7.951 ~ 13.480	38.296 ~ ∞
f/2.8	0.445 ~ 0.455	0.590 ~ 0.610	0.969 ~ 1.033	1.429 ~ 1.579	1.872 ~ 2.147	4.245 ~ 6.085	7.350 ~ 15.664	27.366 ~ ∞
f/4	0.443 ~ 0.457	0.586 ~ 0.615	0.957 ~ 1.047	1.400 ~ 1.616	1.823 ~ 2.217	3.988 ~ 6.711	6.602 ~ 20.700	19.169 ~ ∞
f/5.6	0.440 ~ 0.461	0.580 ~ 0.621	0.941 ~ 1.068	1.364 ~ 1.667	1.760 ~ 2.317	3.690 ~ 7.779	5.814 ~ 36.271	13.703 ~ ∞
f/8	0.436 ~ 0.465	0.572 ~ 0.631	0.917 ~ 1.100	1.313 ~ 1.751	1.675 ~ 2.487	3.319 ~ 10.224	4.933 ~ ∞	9.603 ~ ∞
f/11	0.431 ~ 0.471	0.563 ~ 0.643	0.890 ~ 1.143	1.255 ~ 1.869	1.579 ~ 2.739	2.949 ~ 16.876	4.149 ~ ∞	6.996 ~ ∞
f/16	0.423 ~ 0.482	0.547 ~ 0.665	0.848 ~ 1.223	1.169 ~ 2.106	1.442 ~ 3.297	2.489 ~ ∞	3.283 ~ ∞	4.823 ~ ∞
f/22	0.413 ~ 0.495	0.530 ~ 0.693	0.803 ~ 1.336	1.081 ~ 2.488	1.307 ~ 4.374	2.098 ~ ∞	2.629 ~ ∞	3.519 ~ ∞

Distance scale	1.5'	2'	3'	5'	10'	15'	30'	∞
f/1.2	1.493' ~ 1.508'	1.985' ~ 2.015'	2.964' ~ 3.037'	4.893' ~ 5.111'	9.563' ~ 10.479'	14.024' ~ 16.123'	26.288' ~ 34.941'	209.320' ~ ∞
(f/1.4)	1.491' ~ 1.509'	1.983' ~ 2.017'	2.958' ~ 3.043'	4.876' ~ 5.131'	9.494' ~ 10.564'	13.874' ~ 16.327'	25.757' ~ 35.928'	179.436' ~ ∞
f/2	1.488' ~ 1.513'	1.976' ~ 2.025'	2.940' ~ 3.062'	4.825' ~ 5.189'	9.293' ~ 10.825'	13.442' ~ 16.971'	24.266' ~ 39.255'	125.646' ~ ∞
f/2.8	1.483' ~ 1.518'	1.966' ~ 2.035'	2.917' ~ 3.088'	4.758' ~ 5.268'	9.038' ~ 11.196'	12.907' ~ 17.914'	22.569' ~ 44.791'	89.785' ~ ∞
f/4	1.475' ~ 1.526'	1.952' ~ 2.051'	2.883' ~ 3.128'	4.662' ~ 5.392'	8.680' ~ 11.802'	11.331' ~ 19.544'	20.408' ~ 56.824'	62.890' ~ ∞
f/5.6	1.466' ~ 1.536'	1.933' ~ 2.072'	2.839' ~ 3.182'	4.540' ~ 5.568'	8.247' ~ 12.721'	10.259' ~ 22.248'	18.100' ~ 88.611'	44.960' ~ ∞
f/8	1.452' ~ 1.552'	1.906' ~ 2.104'	2.775' ~ 3.267'	4.368' ~ 5.854'	7.672' ~ 14.408'	10.259' ~ 28.091'	15.479' ~ 556.932'	31.512' ~ ∞
f/11	1.435' ~ 1.573'	1.873' ~ 2.147'	2.699' ~ 3.381'	4.172' ~ 6.257'	7.060' ~ 17.282'	9.178' ~ 41.876'	13.113' ~ ∞	22.955' ~ ∞
f/16	1.407' ~ 1.606'	1.821' ~ 2.221'	2.583' ~ 3.589'	3.882' ~ 7.072'	6.234' ~ 25.943'	7.812' ~ 234.484'	10.459' ~ ∞	15.823' ~ ∞
f/22	1.375' ~ 1.653'	1.763' ~ 2.319'	2.456' ~ 3.879'	3.585' ~ 8.391'	5.470' ~ 65.667'	6.633' ~ ∞	8.425' ~ ∞	11.545' ~ ∞

HELPFUL HINTS ON EXPOSURE PROBLEMS

The light meter built into your KM correctly reads the average of the light reflected from the entire scene as seen through the viewfinder — with a little extra importance, or weight, given to what is in the center. Sometimes, however, there is a great difference between the light reflected from the background and the light reflected from the subject. In such a case, to achieve a really good photo, you must compensate for the difference by opening or closing down the aperture 1 or 2 steps.



As a general rule, when the subject is darker than the background, you compensate by opening your aperture 1 or 2 steps further. For example: on a bright day, when your subject has his back to the sun and you are shooting directly toward the sun . . . or when you are shooting a subject against snow or light-colored sand . . . or when you are copying a page of black letters on white paper, increase the size of the aperture somewhat.

When your subject is brighter than the background — if he is standing in a spotlight, for example — you make the aperture 1 or 2 steps smaller to compensate.

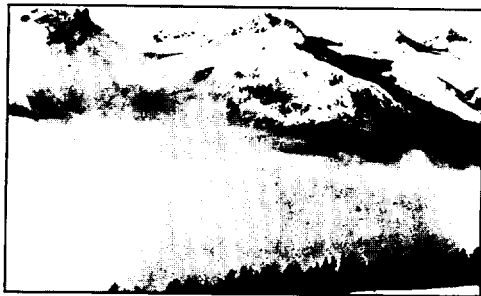

MANUAL SHUTTER OPERATION

The silver oxide battery in your KM is used only for powering the exposure meter; the shutter mechanism is a totally manual operation. Therefore, your camera can still be operated even if the battery is worn out.

(A good sign of a worn-out battery is that the black meter needle does not move when you remove the lens cap.)

If the battery is worn out and the exposure meter is no longer functioning, you must determine the correct combination of shutter speed and aperture size yourself, from your own experience. Also, packed in with most types of 35mm film is a data sheet of suggestions for determining the correct exposure in a variety of situations.

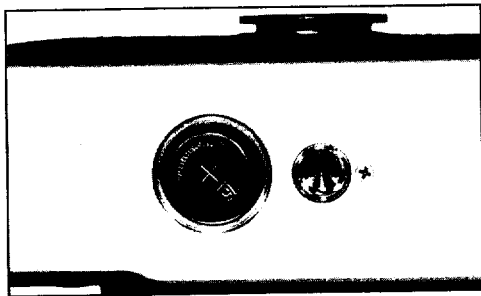

INFRA-RED PHOTOGRAPHY

If you intend to take infra-red photographs, remember to use the infra-red index marked with an orange line on the depth-of-field guide. First, bring your subject into clear focus. Then determine the lens-to-subject distance from the distance scale on the lens. Then match your lens-to-subject distance to the infrared index by turning the distance scale accordingly. For instance, if your subject is in focus at infinity, turn the distance ring and move the infinity (∞) mark to the index.

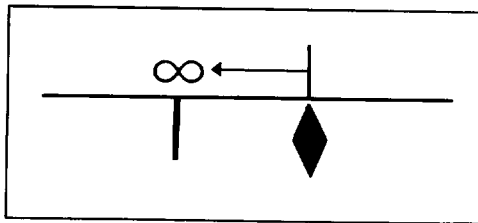
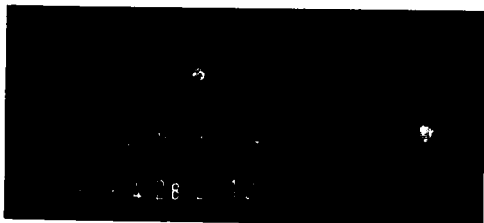

MULTIPLE EXPOSURE

For deliberate multiple exposures, make the first exposure in the normal way. Then tighten the film by turning the rewind knob **A**, and keep hold of the rewind knob. Depress the film rewind release button **B** and cock the rapid-wind lever. This

cocks the shutter without advancing the film. Finally, release the shutter to make the second exposure. Then make one blank exposure, before taking the next picture, to avoid overlapping as registration may not be exact.

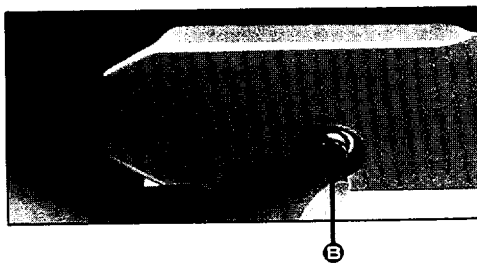
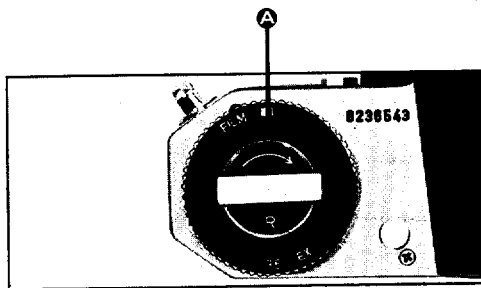

RANGE OF LIGHT MEASUREMENT

The exposure meter of the KM measures the brightness of the ground glass. Therefore, the meter needle should be centered after you have focused your subject on the ground glass. The area (A) in the table indicates the reading range of the meter, and should not be interpreted as the camera's total range of f/stop-shutter speed combinations. As you will note from the table, with an ASA 100 film, you may use any shutter speed from 1/4 sec. to 1/1000 sec. in combination with any aperture that will bring the meter needle to the midpoint in the viewfinder.

The total range of the aperture settings is, of course, determined by the minimum and maximum apertures of the lens being used. For example, with the 50mm f/1.4 lens and ASA 100 film, any aperture from f/1.4 (the maximum aperture of this lens) to f/16 may be used with any shutter speed from 1/4 sec. to 1/1000 sec. that will bring the meter needle to midpoint. However, the combination of f/22 (minimum aperture) and 1/1000 sec. is beyond the measurability range (B), as shown in the table. As the ASA film speed changes, the measurability range varies.

f	
	1.4 2 2.8 4 5.6 8 11 16 22
1	B
$\frac{1}{2}$	
$\frac{1}{4}$	
$\frac{1}{8}$	
$\frac{1}{15}$	
$\frac{1}{30}$	A
$\frac{1}{60}$	
$\frac{1}{125}$	
$\frac{1}{250}$	
$\frac{1}{500}$	
$\frac{1}{1000}$	B

OPEN-APERTURE OR STOP-DOWN METERING

Open-aperture SMC Pentax lenses have a diaphragm coupling lever **A** on the back of the lens which locks into the camera body to permit open-aperture metering. The super telephotos do not have a diaphragm coupler, so they must be used with the stop-down metering system. Use of the Auto-Extension Tube Set K permits open-aperture metering. It can also be set to stop down the diaphragm automatically. Use of other K Series accessories — standard Extension Tube Set K, Helicoid Extension Tube K, Auto-Bellows K and Bellows Unit K — requires stop-down metering. Whenever any one of these is used between the camera body and an SMC Pentax lens, the stop-down metering system must be used.

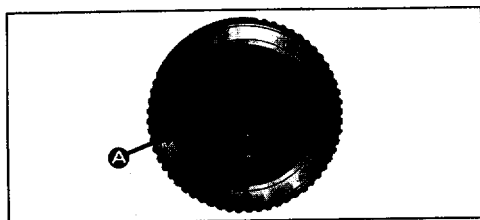

OPEN-APERTURE METERING LENSES

SMC Pentax Fish-eye	17mm	f/4
SMC Pentax	15mm	f/3.5
SMC Pentax	20mm	f/4
SMC Pentax	24mm	f/3.5
SMC Pentax	28mm	f/3.5
SMC Pentax	35mm	f/2
SMC Pentax	35mm	f/3.5
SMC Pentax	50mm	f/1.2
SMC Pentax	50mm	f/1.4
SMC Pentax	55mm	f/1.8
SMC Pentax	85mm	f/1.8
SMC Pentax	105mm	f/2.8
SMC Pentax	120mm	f/2.8
SMC Pentax	135mm	f/2.5
SMC Pentax	135mm	f/3.5
SMC Pentax	150mm	f/4
SMC Pentax	200mm	f/4
SMC Pentax	300mm	f/4
SMC Pentax Zoom	45 ~ 125mm	f/4
SMC Pentax Zoom	85 ~ 210mm	f/4.5
SMC Pentax Macro	50mm	f/4
SMC Pentax Macro	100mm	f/4

STOP-DOWN METERING LENSES

SMC Pentax	400mm	f/5.6
SMC Pentax	500mm	f/4.5
SMC Pentax	1000mm	f/8
SMC Pentax Zoom	135 ~ 600mm	f/6.7

USING CONVENTIONAL SCREW-MOUNT TAKUMAR LENSES

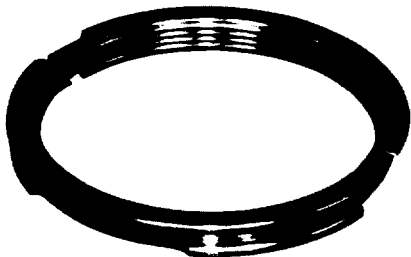

Conventional screw-mount Takumar lenses (both Super-Takumar and SMC Takumar) can be easily mounted onto your camera by attaching them first to a Mount Adaptor K. Use of the Mount Adaptor K does not affect any aspect of normal lens function except as regards the following two points:

1.

Due to the difference in coupling systems, the automatic diaphragm will not function.

2.

Full-aperture metering lenses will function as stop-down metering lenses.

HOW TO USE MOUNT ADAPTOR K

1. Screw the conventional Takumar lens into the Mount Adaptor K.
2. Attach the Adaptor/lens unit to the camera body by aligning the red dots **A** and **B**, and turning the lens clockwise until it locks with a click. (This takes slightly less than a quarter of a revolution.)
3. To remove the lens, leaving the Mount Adaptor K attached to the camera body, simply unscrew the lens counter-clockwise. Other screw-mount Takumar lenses can then be attached in the normal way.

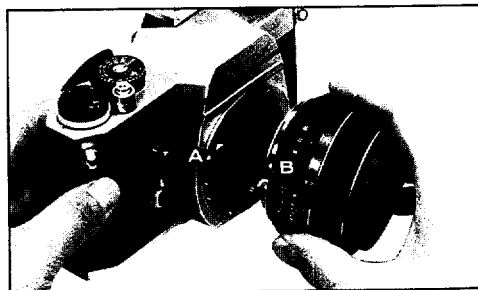

1. To remove the Mount Adaptor K from the camera body, first remove the screw-mount lens. Then press, with your thumbnail or a pointed object such as a ballpoint pen, against the spring pin **C**.
2. Turn the Mount Adaptor K counter-clockwise until you feel it release, and take it out.
3. Since the mechanism for locking in the Mount Adaptor K is totally different from that which locks in an SMC Pentax bayonet-mount lens, the lock lever **D** on the camera body plays no part at all.

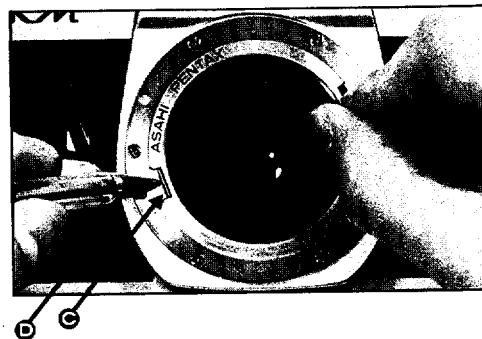

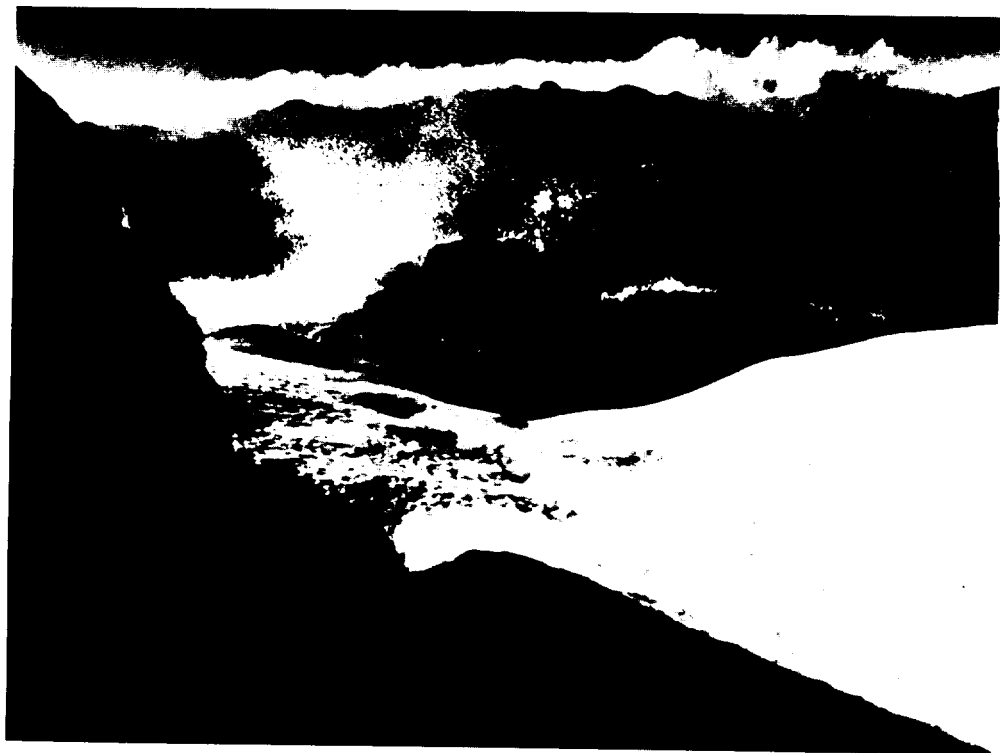

RESISTANCE TO TEMPERATURE EXTREMES AND CHANGES

The temperature range at which your camera will continue to function properly stretches from 50°C to -20°C. However, resistance to cold could be hampered by oil which has become dirty. Therefore, if the camera is to operate at full efficiency in very cold conditions, it must be overhauled and all oil must be replaced.

Sudden changes in temperature will often cause moisture to condense inside or outside your camera. This is a possible source of rust, which may be extremely damaging to the mechanism. Furthermore, if the camera goes from a warm temperature to a sub-freezing one, and if tiny drops of moisture freeze, further damage may be done by their expansion.

Thus, sudden temperature changes should be avoided as much as possible. As a guide, a temperature change of 10°C should be allowed to take place gradually over a period of at least 30 minutes. If this is not possible, keeping the camera in its case or bag will help somewhat in minimizing the effects of a rapid temperature change.

Extremely low temperature reduces the efficiency of the battery. Therefore, the camera should be protected against low temperature. Put the batteries into the camera right before shooting. For extremely low temperature, use new batteries.

CAMERA MAINTENANCE

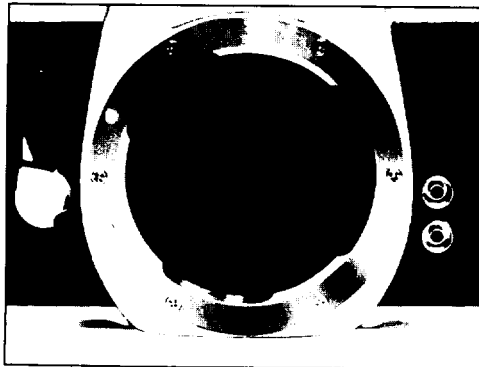
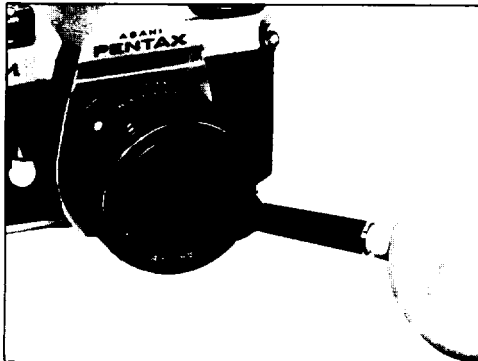

Always keep the viewfinder eyepiece, lens and filter as clean as possible. To remove loose dust and dirt, first use the blower and then the brush of a lens brush. Do not try to wipe off granular dirt or dust — it's an excellent way of scratching the glass.

Smudges, such as fingerprints, should be carefully wiped away with either a lens tissue or a clean, soft cloth. Clean, plain cotton handkerchiefs that have already been washed a few times are particularly good for this.

Breathing on the lens before wiping is effective; but be sure to wipe away all moisture completely.

Commercial lens cleaners are also effective.

Never touch the mirror or the shutter curtains. Minor dirt or spots on the mirror will not affect the clarity of your pictures. mirror will not affect the clarity of your pictures.

Take care not to drop the camera or knock it against anything solid. Accidents or rough handling can easily damage the internal mechanism, even though externally nothing seems to have been hurt.

Your camera is **not** waterproof. There are several places where water can get inside and do a

great deal of damage. Take care to protect both body and lens from rain or splashing water. If your camera should get wet, dry it off immediately with a clean, soft cloth. Once a camera has become completely soaked, there is often nothing that can be done to make it right again. However, in such a case, take your camera as soon as possible to an authorized Asahi Pentax Service Center.

Where to keep your camera while you are not using it is an important point. The best storage place is cool, dry, clean and well-ventilated. Because of the possible build-up of humidity, it is risky to store your camera in a cabinet or closet. It's also a good idea to keep your camera in its bag or case while you are not using it.

When mounting your camera on a tripod, be sure the tripod screw is no longer than 5.5mm. This is the depth of the tripod screw hole on your camera. If you use a longer screw, you will probably puncture the bottom of the hole, after which the camera will not function properly.

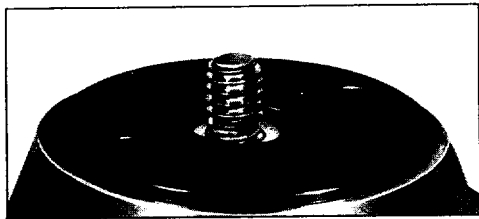

WARRANTY POLICY

All Asahi Pentax cameras purchased through authorized bona fide photographic distribution channels are guaranteed against defects of material or workmanship for a period of twelve months from date of purchase. Service will be rendered and defective parts will be replaced without cost to you within that period, provided the equipment has not been abused, altered, or operated contrary to instruction. Because the tolerances, quality, and design compatibility of lenses other than Pentax lenses are beyond our control, damage caused by use of such lenses will not be covered by this warranty policy. The manufacturer or its authorized representatives shall not be liable for any repair or alterations except those made with its written consent and shall not be liable for damages from delay or loss of use or from other indirect or consequential damages of any kind, whether caused by defective material or workmanship or otherwise; and it is expressly agreed that the liability of the manufacturer or its representatives under all guarantees or warranties, whether expressed or implied, is strictly limited to the replacement of parts as hereinbefore provided.

PROCEDURE DURING 12-MONTH WARRANTY PERIOD

Any Asahi Pentax which proves defective during the 12-month warranty period should be returned

to the dealer from whom you purchased the equipment or to the manufacturer. If there is no representative of the manufacturer in your country, send the equipment to the manufacturer, with postage prepaid. In this case, it will take a considerable length of time before the equipment can be returned to you owing to the complicated customs procedures required in Japan in importing and re-exporting photographic equipment. If the equipment is covered by warranty, repairs will be made and parts replaced free of charge, and the equipment will be returned to you upon completion of servicing. If the equipment is not covered by warranty, regular charges of the manufacturer or of its representatives will apply. Shipping charges are to be borne by the owner. If your Asahi Pentax was purchased outside of the country where you wish to have serviced during the warranty period, regular handling and servicing fees may be charged by the manufacturer's representatives in that country. Notwithstanding this, your Asahi Pentax returned to the manufacturer will be serviced free of charge according to this procedure and warranty policy. In any case, however, shipping charges and customs clearance fees are to be borne by the sender. To prove the date of your purchase when required, please keep the receipts or bills covering the purchase of your equipment for

at least a year. Before sending your equipment for servicing, please make sure that you are sending it to the manufacturer's authorized representatives or their accredited repair shops, unless you are sending it directly to the manufacturer. Always obtain a quotation of the service charge, and only after you accept the quoted service charge, instruct the service station to proceed with the servicing.

This warranty policy does not apply to Asahi Pentax cameras purchased in the U.S.A. For these cameras, please refer to the separate Warranty Policy Card enclosed here.



Asahi Optical Co., Ltd. C.P.O. 895, Tokyo 100-91, JAPAN
Asahi Optical Europe N.V. Weveldaan 3-5, 1930 Zaventem Zuid-7, BELGIUM
Pentax Handelsgesellschaft mbH. 2000 Hamburg 54 (Lokstedt), Grandweg 64, WEST GERMANY
Pentax Corporation 35 Inverness Drive East, Englewood, Colorado 80112, U.S.A.
Pentax of Canada Ltd. 1760 West 3rd Avenue, Vancouver, B.C. V6J 1K5, CANADA
Pentax U.K. Ltd. Pentax House, South Hill Avenue, South Harrow, Middlesex HA2 0LT, U.K.
Asahi Optical Brasileira Ind. e Com. Ltda. Rua Estados Unidos, 1053, Sao Paulo SP, BRASIL