

# PENTAX

## ME IF

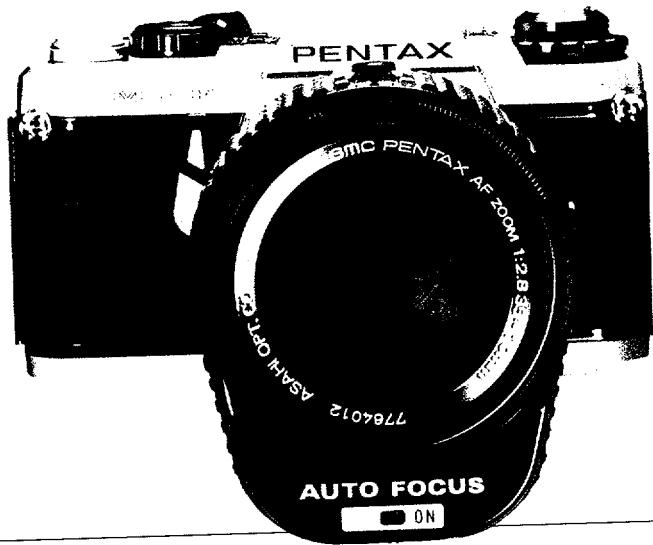

## DESCRIPTION OF PARTS

- Ⓐ Power switch
- Ⓑ Focusing ring
- Ⓒ Focusing buttons

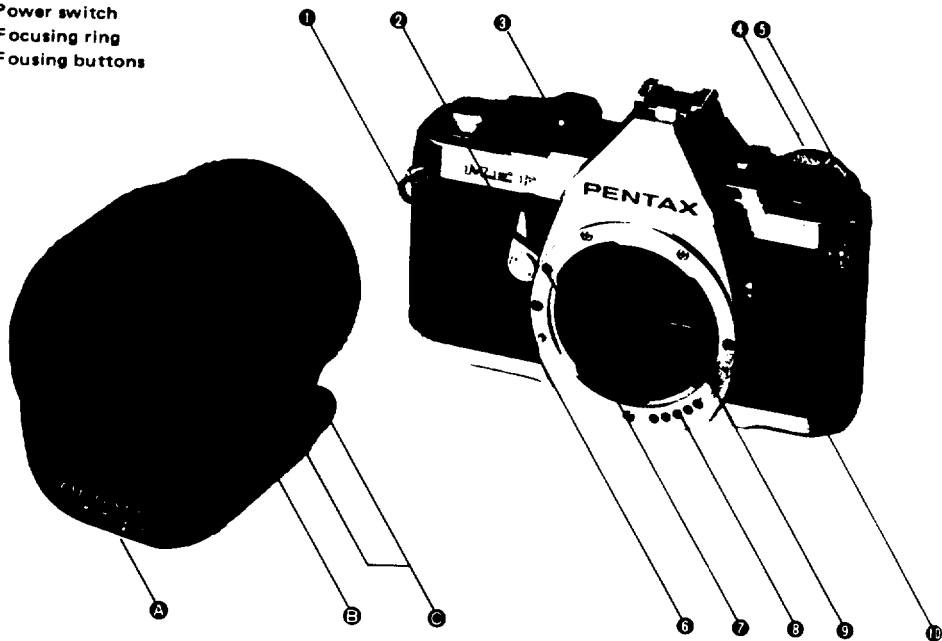

- ① Neck strap eyelet
- ② Self-timer lever
- ③ Shutter mode index button
- ④ Film rewind crank
- ⑤ Film rewind/back cover release
- ⑥ Lens release lever
- ⑦ Lens alignment index
- ⑧ Auto focus contacts
- ⑨ Instant return mirror
- ⑩ X-synch terminal
- ⑪ Aperture ring
- ⑫ Lens aperture index
- ⑬ Distance index
- ⑭ Distance scale
- ⑮ Lens alignment node
- ⑯ Focusing ring
- ⑰ ASA film speed index
- ⑱ Exposure compensation dial
- ⑲ Audio focus switch
- ⑳ Electro focus selector

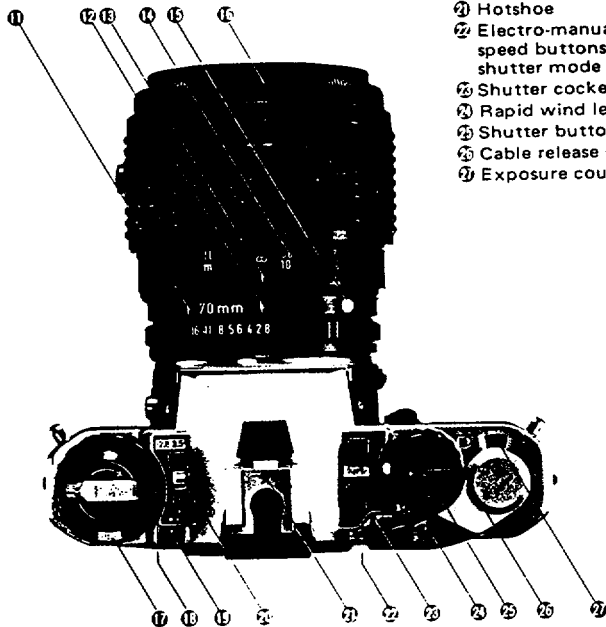

- ㉑ Hotshoe
- ㉒ Electro-manual shutter speed buttons
- ㉓ shutter mode indications
- ㉔ Shutter cocked indicator
- ㉕ Rapid wind lever
- ㉖ Shutter button
- ㉗ Cable release socket
- ㉘ Exposure counter



## CONTENTS

Basic operating instructions "Your ME-F Quick Course" .....	4
Inserting batteries .....	10
Lens mounting .....	12
Film loading and winding .....	13
Setting the ASA film speed/Memo holder .....	15
The shutter mode dial .....	16
Aperture setting .....	18
Auto focus (with SMC Pentax AF 35mm-70mm AUTO FOCUS ZOOM LENS).....	19
TTL electronic focus (with regular SMC Pentax Interchangeable lenses) .....	30
Manual focus .....	38
Exposure on "Auto" .....	39
Auto exposure compensation .....	42
Manual exposures at "M" .....	44
Holding the camera .....	48
Unloading the film .....	49
Self-timer/Multiple exposures .....	50
Using a tripod/Time exposures at "B" .....	51
Flash photography (with Pentax dedicated flash units) .....	52
Other flash units .....	53
Shooting pointers .....	54
Depth-of-field scale .....	56
Depth-of-field table .....	57
Using screw mount Takumar lenses .....	58
Infrared photography .....	60
Open aperture and stop-down metering .....	61
Camera maintenance .....	62
Resistance to temperature extremes and variations .....	63
Meter coupling range .....	64
Viewfinder diagram .....	66
Specifications .....	68
Warranty policy .....	72

## Welcome to the World of Electro Focus Photography!

Your ME-F is a truly unique camera which has a host of features to make SLR photography easier than ever before. Its revolutionary built-in through-the-lens Electronic Focus Control (TTL-EFC) System has improved focusing accuracy and convenience for everyone.

When the ME-F is used with the new Pentax AF Zoom 35mm–70mm f/2.8 Auto Focus Lens, this system provides you with complete auto focus simply by pressing a button on the lens barrel. Because the focus control is integrated into the camera body, the Pentax auto focus zoom is more compact than the conventional external auto focusing systems for SLR cameras.

When the ME-F is used with any of over 30 standard K-mount SMC Pentax interchangeable lenses (and also screw-mount lenses with Mount Adaptor K), the same built-in electronic focus system provides focus guidance that enables quick and accurate focus simply by turning the lens in the direction of an arrow. When the large green viewfinder LED glows and an audible signal sounds, it informs you that focus is correct.

Either way you use it—for complete auto focus with the new AF Zoom lens, or for focus guidance with your regular SMC Pentax interchangeable lenses, this new system will help you to focus with more accuracy and speed than conventional focusing systems.

Aside from its revolutionary focusing system, the ME-F has several other improved features such as fully automatic exposure with tri-color exposure guides, pushbutton-controlled manual exposures, a super-fast 1/2000th second top shutter speed, a brilliant Clear-Bright-Matte viewfinder, all in its easy handling, compact body. Also, it operates in conjunction with over 200 Pentax system accessories, including two winders, four dedicated flash units, and offers a wide range of special purpose photo capabilities from close-up, macrophotography and architectural photography with the shift lens to photomicrography and astrophotography. (For details, ask your photo dealer for the booklet entitled, "PENTAX LENSES AND ACCESSORIES.")

#### **HOW TO USE THIS MANUAL**

To get you started right away, we've provided a "Quick Course" on pages 4 to 8 which gives you the basics of operating your camera in the auto exposure mode. Use of the camera with the Auto Focus Lens is explained first, followed by the electronic focusing with other Pentax interchangeable lenses. Be sure to first read the section which is pertinent for the type of lens you are using. Also, read the entire manual the first chance you get in order to make the most of all the benefits your camera has to offer.

Last but not least, take good care of your ME-F—It's destined to become a classic!

## BASIC OPERATING INSTRUCTIONS

### "Your ME-F Quick Course"

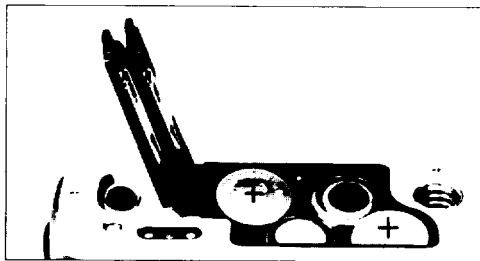

1. Insert the four batteries as shown. (Page 10);  
Mount the lens (Page 12).

2. Load the film with the shutter mode dial set at "125X" and advance to the first exposure. (Page 13).

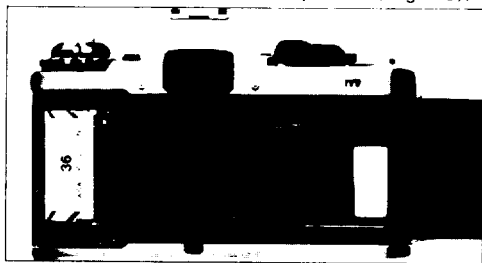
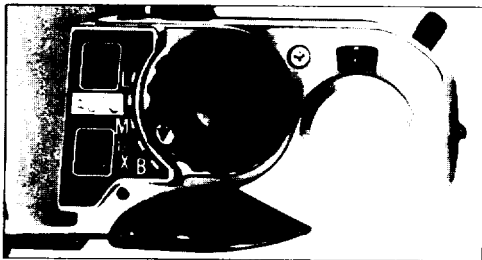



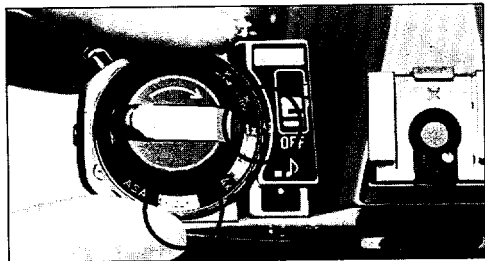

3. Set the ASA film speed (Page 15) Set the exposure compensation dial at 1X (Page 42).

5. Set the lens aperture. (Page 18).

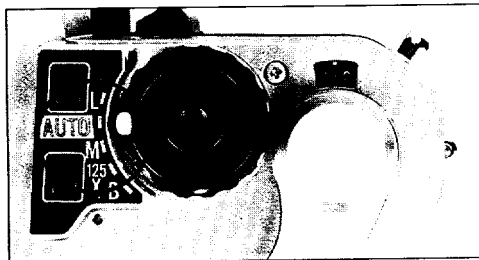
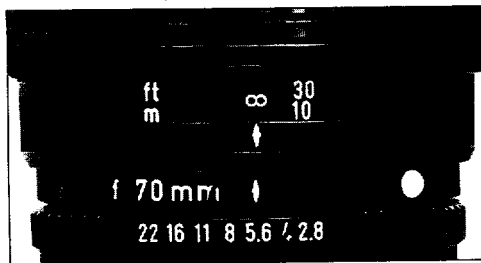

4. Set the shutter mode dial to "AUTO" (Page 16).

6. Look through the viewfinder, focus and compose the picture.

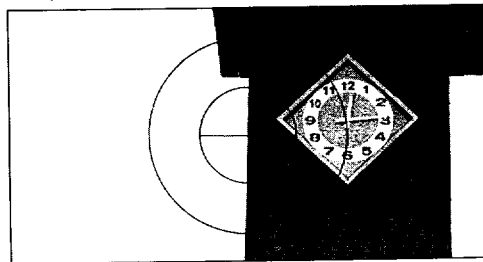

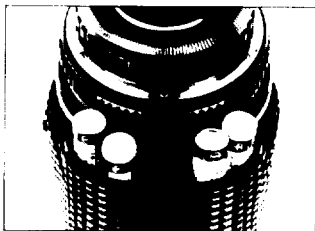

- Insert the lens batteries (Page 21); Mount the lens. (Page 12).

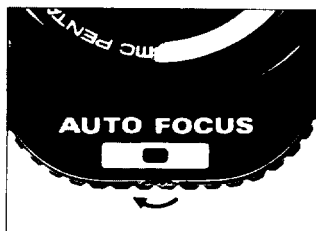

- Set the power switch to ON.

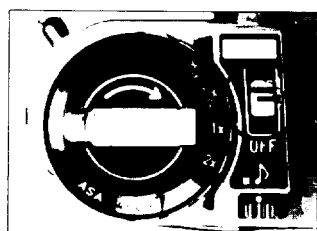

- Set camera electro focus selector to ~2.8

- Center subject in split-image center spot of viewfinder.

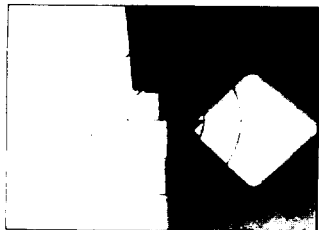

- Press either focus button on lens.

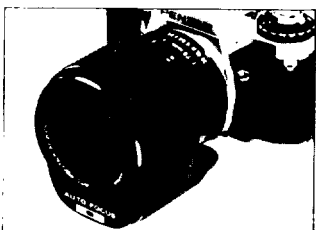

- Take photo when lens stops turning; green LED glows at base of finder.

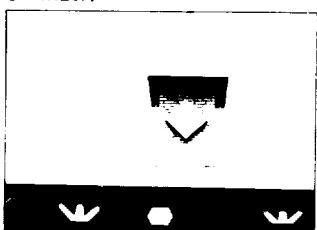

# TTL ELECTRONIC FOCUS (WITH REGULAR SMC PENTAX INTERCHANGEABLE LENSES) PAGE 30

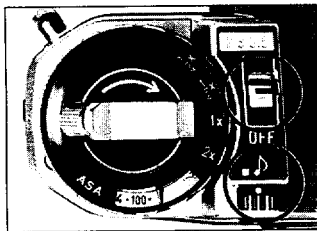

- Set the focus selector to ~2.8 for standard lens (for other lenses see Page 31).

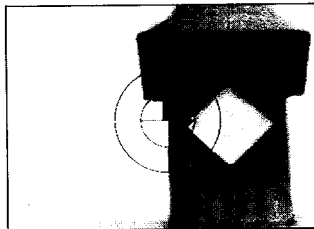

- Center the subject in the split-image center spot of viewfinder.

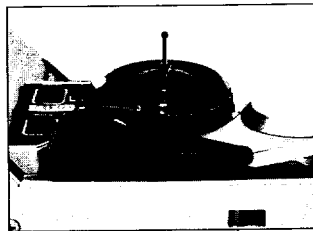

- Press shutter button partway to activate the finder display.

- Turn the lens in the direction of the arrow.

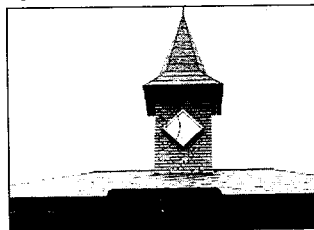
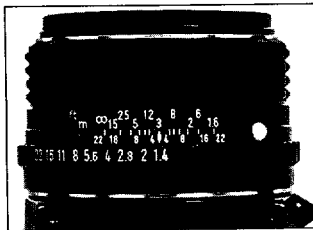
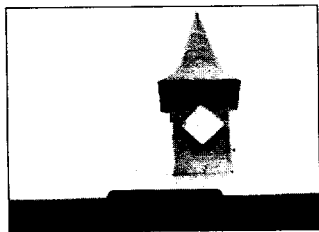

- Stop when the green LED lights.

7. Activate the meter by pressing the shutter button partway.  
(Page 39 – 41).

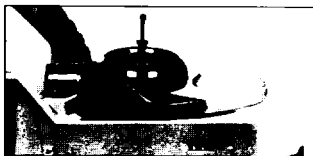

If the green LED lights (between "2000" and "60") take photo.



If red OVER or UNDER LEDs light:

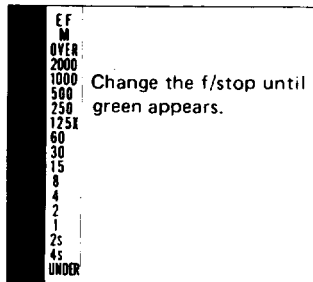

If YELLOW LEDs light  
(between "30" and "4S"):

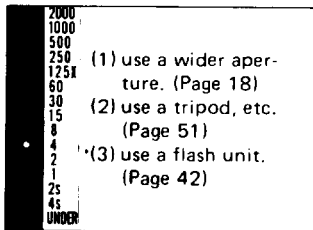

# **OPERATING INSTRUCTIONS**

## INSERTING BATTERIES

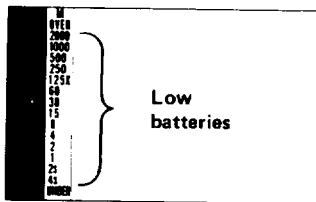
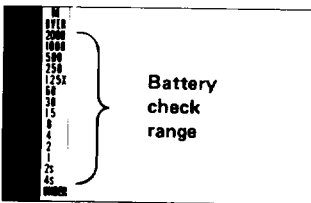
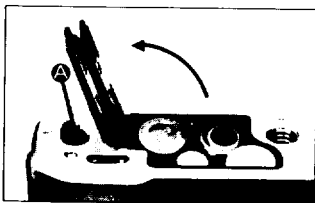

The electronic systems of your Pentax ME-F operate on four 1.5-volt mini batteries (S76, etc.) which are packed separately with your camera.

**To insert the batteries:** Open the battery compartment cover by sliding it in the direction of the arrow, while depressing the battery compartment lock release button (A). Place the four batteries in the chamber, with polarity markings as shown.

Close the compartment cover and slide it so that it locks in place.

**Battery Check:** After inserting the batteries, make a quick check to see that the batteries are inserted properly and that the camera's electrical systems are functioning. **To check batteries:** Press the shutter button partway and observe the viewfinder LED shutter speed display. One of the shutter speed LEDs (i.e. those between "2000" and "4S") will glow continuously if the voltage supply for the camera's exposure system is adequate.

**Low Battery Warning:** When batteries become too weak for the exposure system to operate, the viewfinder shutter LEDs will begin to flicker.\* Although the camera will continue to make accurate exposures for both the AUTO and M electronic exposure modes until the display goes out completely, **all four** batteries should be replaced promptly at this point to ensure uninterrupted operation.

\*NOTE: LEDs other than the shutter speed LEDs (i.e. "OVER – "UNDER" – "EF" – and "M") normally flicker depending on the operating modes; this should be disregarded as low battery indication.

**Mechanical Shutter Speeds:** If batteries fail and you're caught without spares, manual exposures without the meter can be made at the "125X" (1/125 sec.) and "B" mechanical shutter speeds. See page 17.

**Battery Check for TTL Electronic Focusing System:** See page 37.

#### **Battery Care:**

- Battery life will vary from a short time to several months depending on the frequency of operation of the electronic exposure and focusing systems. Should batteries require replacement, replace all four with equivalent 1.5 volt silver oxide batteries (Eveready S76, MALLORY S76E, etc.)
- Do not mix battery brands and types, nor old batteries with new batteries. (This is dangerous and could actually shorten battery life).
- Wipe the battery with a dry cloth before insertion and always handle by the edges to ensure proper contact.
- Keep spare batteries on hand to help avoid the inconvenience of battery failure during busy picture-taking sessions. When shooting in cold climates where temporarily failure due to extreme temperatures is not uncommon, keep spares in a warm pocket.
- When not using the camera for long periods of time, remove batteries to protect against leakage.

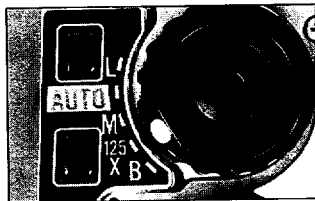

#### **IMPORTANT!**

Never throw used batteries into fire or expose to excessive heat as a precaution against explosion. Always keep batteries out of the reach of children.

## LENS MOUNTING

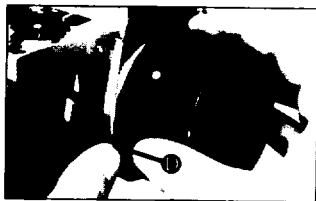
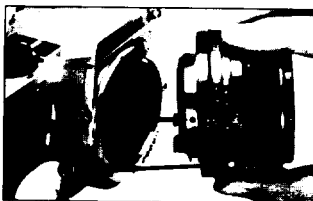

**NOTE:** Mounting instructions are the same for both regular SMC Pentax Lenses and the AF zoom lenses. (for screw-mount lenses, see page 58). **With the auto focus zoom lens, be sure to insert batteries first.**

- Remove the rear lens and body mount covers. Hold the camera firmly in your left hand and match the red dot (A) on the camera body with the red dot (B) on the lens.
- Seat the lens in the body mount and turn it clockwise until it locks into place with a "click." In the dark when the red dots are difficult to see, align the raised white node (C) on the lens barrel with the lens release lever (D) by touch and mount the lens as described.

**Removing the lens:** To remove the lens, hold the camera in the left hand and press the lens release button (E) while turning the lens counter-clockwise with the right hand.

### IMPORTANT

\* If it becomes necessary to put the lens down without the rear lens cap, make sure to rest the lens **with the front element down**; never put the lens down with the front element up. (Long telephoto lenses should be laid on their side to avoid tumbling; the auto focus lens may conveniently be rested on the battery compartment).



## FILM LOADING AND WINDING

- To avoid unnecessary delays when loading the film, before starting it's best to set the shutter mode dial to "125X." If you must load the film with the dial set to "AUTO," remove the lens cap and aim the camera toward a bright light source to avoid excessively long shutter speeds during film advance. If you advance the film with the dial set to "M," make sure to use one of the faster manual shutter speeds.

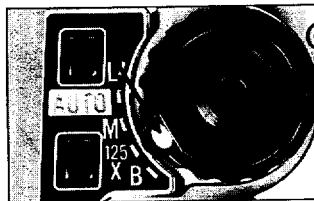

- Open the camera back by lifting up sharply on the film rewind knob. Insert the film cartridge in the film chamber and lock the cartridge in place by returning the film rewind knob to its original position.

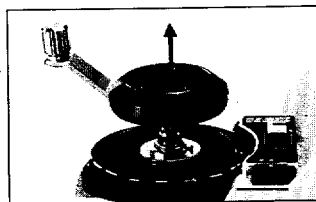

- Draw the film leader across the back and insert it into any of the white needles in the film take-up spool. Make sure the film is engaged properly on the spool by inserting the leader at least the width of one perforation.

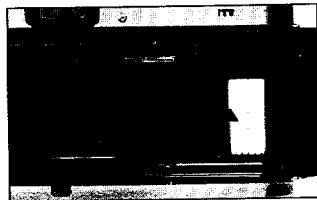

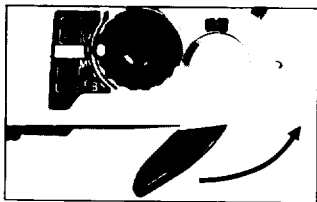

- Wind the film by alternately advancing the rapid wind lever and firing the shutter release button until **both** top and bottom sprockets engage the film perforations.

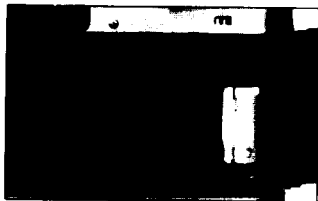

- When you are sure the film has engaged properly, close the back cover and wind the film rewind crank in the direction of the arrow to take up any slack.

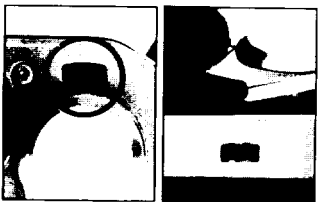

- Continue advancing the film until the exposure counter registers "1." You can be sure the film is moving properly through the camera by checking to see that the film advance indicator on back of the camera flickers.

**Reset the shutter dial to "Auto."**

## SETTING THE ASA FILM SPEED/MEMO HOLDER

The ASA film speed rating of all 35mm films is given in the data sheet packed with each roll of film. The higher the ASA number, the more sensitive the film is to light. To set the index, lift up the ASA dial  and turn it until the ASA number of your film is opposite the orange index mark.

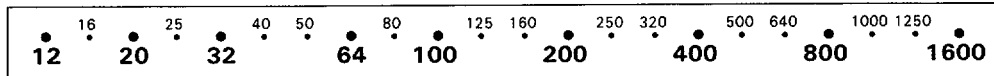
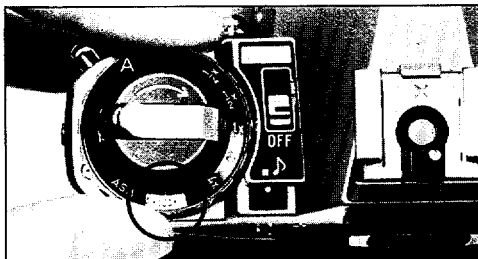

### MEMO HOLDER

As a reminder of the type of film in your camera, tear off the top of film box and insert it into the Memo Holder on the back cover of the camera.

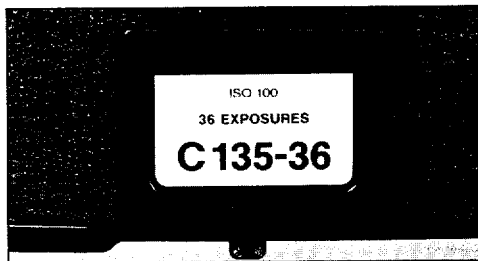

## THE SHUTTER MODE DIAL

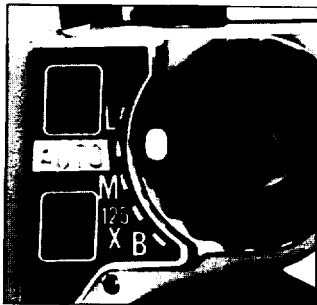

Because the camera selects the shutter speed in the "AUTO" exposure mode and pushbuttons are used to set the shutter speed in the "M" electro-touch manual mode, the shutter speed dial has been eliminated on your ME-F. In its place is the shutter mode dial, whereby you simply select the desired mode of exposure before photographing. In addition to the four mode settings, the dial also features a shutter button lock.

**To set the dial:** Press down on the small white button on top of the dial and rotate the dial until the button aligns with the desired mode setting.

**"AUTO":** This is the most convenient exposure mode for general shooting. Set the dial set to "AUTO" and the camera chooses the correct shutter speed for you automatically in relation to the preset lens aperture, saving you the time required for setting the exposure entirely yourself, and allowing you to concentrate on framing and composition. For normal daylight shooting, you can preset the lens aperture at  $f/5.6$  or  $f/8$  and obtained well-exposed photos simply by focusing and pressing the shutter button (See EXPOSURES ON AUTO—page 39).

**"M" (Manual):** This is the ME-F's extremely convenient electro-touch manual exposure whereby you choose your desired shutter speed simply by pressing either of two push buttons. Whereas shutter speeds vary continuously in the "AUTO" mode, with the shutter dial set to "M," you may freeze the shutter speed at any one of fourteen viewfinder shutter speed settings. (See "MANUAL EXPOSURE AT M" — page 44).

**"125X":** This 1/125th-second mechanical shutter speeds setting is provided primarily for flash synchronization with electronic flash units other than Pentax dedicated flash units (See page 53). As the shutter operates without batteries, it allows you to still operate the camera in case of battery failure. In this instance, set the dial to "125X" and adjust the lens aperture according to subject brightness (refer to the exposure guide lines accompanying your film).

**"B" (Bulb):** This setting is for long exposures exceeding the 4-second maximum shutter speed range of the camera's electronic exposure system. Time exposures lasting several minutes or hours can be made at this setting (See "TIME EXPOSURES AT "B,"" page 51).

**"L" (Lock):** Set the shutter dial to "L" and the shutter button may be locked while the shutter dial is cocked to prevent accidental shutter release. **To disengage the lock:** reset the dial to the exposure mode desired and release the shutter.

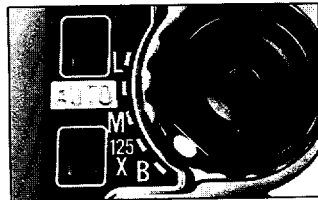
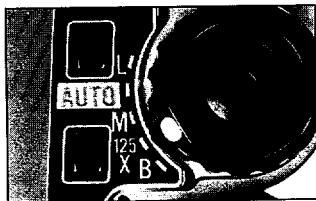
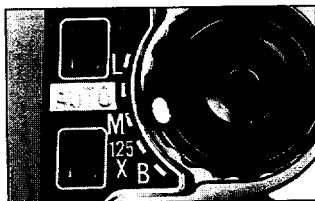

## APERTURE SETTING

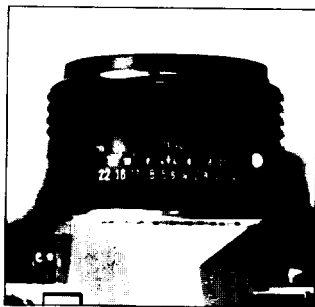
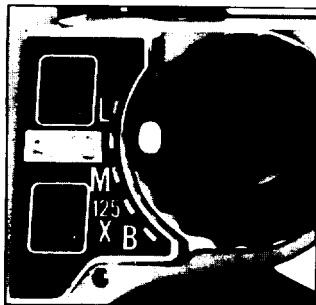

Preselection of the lens aperture is optional when shooting in the "M" (Manual) mode. However, when shooting on "AUTO", it is recommended that you preset the aperture. This is because the shutter speed selected by the automatic exposure system is determined in relation to the lens aperture used. By presetting the aperture control ring to an f-number that is appropriate for lighting conditions in the picture, problems of over and underexposure can be largely eliminated. When shooting on "AUTO" (or Manual when applicable), preset the lens aperture as suggested in the following table.

Fine weather .....	f/8 – f/11
Cloudy weather .....	f/4 – f/5.6
Indoors .....	f/1.4 – f/2.8

**To set aperture:** The calibrations on the aperture control ring of the lens are referred to as f-numbers or f-stops and denote the size of the lens aperture. To set the aperture, align the figure equivalent to the recommended f-number with the diamond index mark.

**Note on f-numbers:** Lower f-numbers (such as f/1.4) denote wider lens apertures, while higher-f-numbers (such as f/22) denote smaller apertures. With the 50mm f/1.4 lens, for example, f/1.4 is the widest, aperture or "open-aperture," while f/22 is the smallest aperture or "minimum aperture." As the size of the aperture also affects the overall sharpness of the photo, you may occasionally wish to vary the aperture setting from the norm for different effects (See page 54).

## **AUTO FOCUS**

(WITH SMC PENTAX AF 35mm – 70mm ZOOM LENS)

The SMC Pentax AF 35mm–70mm Auto Focus Zoom Lens allows you to fully realize the potential of your ME-F camera. With this new system, you can automatically focus by simply pressing a button on the lens. Moreover, because the auto focus control is inside the camera, your lens is more compact than with non through-the-lens auto focus systems, (the only size additions being a micro motor and a battery compartment).

If you are focusing with the auto focus lens, please read this section carefully to fully understand all the benefits it has to offer. If you are focusing with regular SMC Pentax interchangeable lenses, skip to the electronic focusing section (See page 30). Also, be sure to read the manual focusing section.

## DESCRIPTION OF PARTS

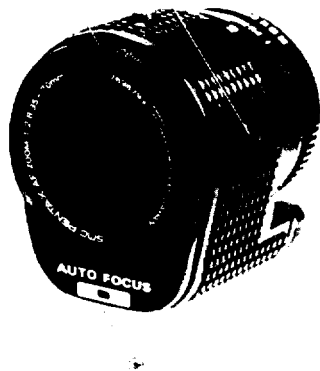

- ① Focusing ring
- ② Focusing buttons
- ③ Power switch
- ④ (Push/Pull) zoom collar
- ⑤ Battery compartment
- ⑥ Battery compartment lock release
- ⑦ Auto focus contacts

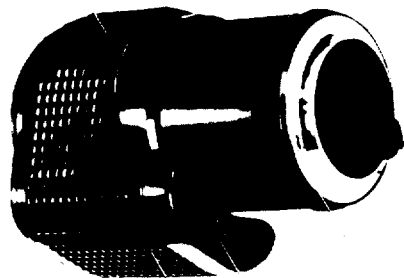

① ② ③ ④



## INSERTING BATTERIES

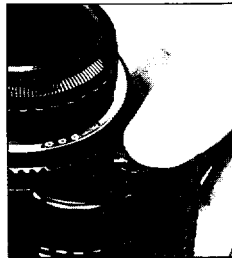
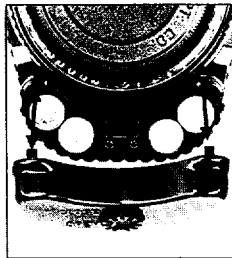
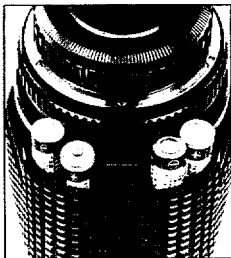
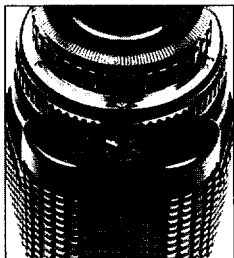

- The battery compartment for the auto focus lens is located at the back of the lens beneath the lens mount. To open the compartment, press the dial down and turn to the OPEN position. The cap will release.
- Insert four 1.5-volt AAA-size batteries according to the direction inside the compartment. Be sure to insert the batteries exactly as indicated for the motor to work.

- To close the compartment, replace the cover. Push the dial down and turn to "CLOSE." Your lens is now ready for use.
- Mount the lens on the camera (in the normal manner) as described on page 12. Make sure to turn the lens until it clicks in place.

**NOTE:** Use either alkaline or manganese batteries, do not use rechargeable NiCad batteries.

## LENS OPERATION

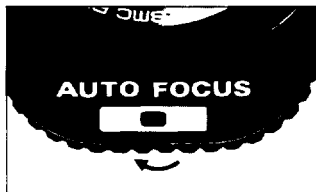

- Set the power switch on the front of the lens to ON.
- Look through the viewfinder and center your subject in the split-image center spot.  
*Make sure that the points of highest contrast bisect the split-image line.*

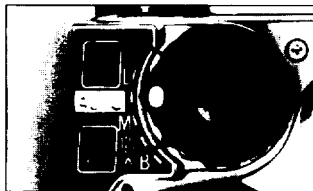
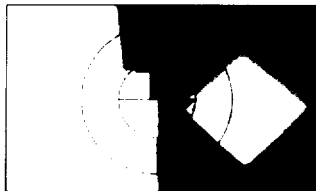

- Set the shutter mode dial of the camera to "Auto" (other settings except "B" may also be used)

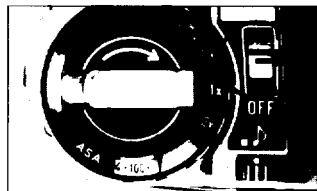

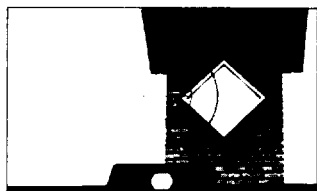

- Set the electro-focus button on top of the camera to ~2.8.

- Press either of the focusing buttons on the lens barrel. When it reaches the point of correct focus, the lens will stop turning; the large green LED display in the viewfinder will light, indicating focus is correct.



**As the motor turns, the following indications are possible.**

	<b>ONE ARROW:</b> Direction in which the lens is focusing.
	<b>TWO ARROWS:</b> Lighting/contrast is too flat for auto focus – focus manually.
	<b>GREEN LIGHT (LED):</b> Subject is in focus; make the exposure reading and take the picture.
<b>TO FOCUS, PRESS THE BUTTON ON THE LENS BARREL, CENTER THE SUBJECT IN VIEWFINDER: TAKE PHOTO WHEN LENS STOPS TURNING.</b>	

**NOTE:** *The subject doesn't have to be aligned precisely in the split-image center spot for correct focus with the auto focus lens.*

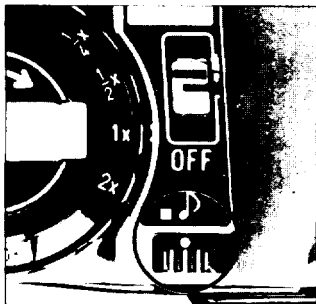

**Audio Focus Indication:** The ME-F provides you with an audible signal which accompanies the LED correct focus indicator. This signal tells you when to take the picture. To operate the audio focus indicator, set the audio focus switch to the musical note. When not needed, turn the audio focus indicator off simply by sliding the switch from the musical note back to the black square.

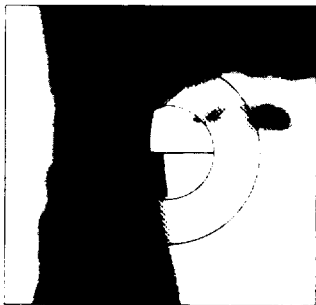

**Hints for good results:** Your ME-F's through-the-lens auto focusing system will give you perfectly focused photos when used properly. For best results, be sure to place the highest contrast portion of the subject in the split-image center spot. For example, if photographing a person, focus on his or her silhouette as it stands out from the background. For close-up portraits, focus on facial details.

**Foreground Information:** The TTL auto focusing system focuses for the object in the center of the viewfinder that is closest to the camera. For this reason, make sure that objects in front of your key subject do not cross the split-image center line. Correct focus will be obtained even with foreground objects as long as they do not cross the split-image center line.



**Picture Composition:** When composing a picture, first focus on the key subject. Remember, the auto focusing system reads only the subject which bisects the split-image line of the viewfinder, so keep the subject in the center until the focus locks on the subject, then frame your subject as you like.



**ZOOMING:** To zoom, pull the lens barrel out for wide angle settings, and pull back for telephoto. Best results are obtained if you focus at the telephoto setting first, then adjust to the desired focal length. This way you obtain a larger image for focusing, and foreground matter which might distract the focusing sensor is easily eliminated.





**IMPORTANT:** When contrast and lighting are insufficient for focusing, the motor will turn back and forth slowly. If this occurs, stop focusing immediately to avoid wasting batteries.

**On some occasions you will have to focus manually**

While your auto focus system is extremely accurate, there will be occasions when you will have to focus manually.

When manual focus is required both LEDs inside the viewfinder light simultaneously (or flash depending on lighting conditions), informing you to focus manually.

For manual focus, turn the front of the lens barrel and focus in the conventional manner with the split-image, microprism or entire focusing screen as indicated on page 38).

These situations arise mainly when lighting is insufficient or contrast is too flat for the sensor to read the subject. Examples include photographing indoors in dimly lit room, outdoors at dawn, twilight or in heavy shade or overcast. (EV 5.5, at ASA 100, 1 sec. at f/6.7).

Subjects without contrast, such as a white wall also present a problem, as do excessively bright subjects, strong backlighting, fast moving subjects, very fine patterns or lines, and subjects with extreme contrast (over EV 17.5; 1/500 sec. at f/19).

**Note:** Even with subjects lacking contrast, the system can sometimes be made to work if some mark or distinguishing feature of the subject is placed in the center spot of the viewfinder, such as the bicycle tire in the top photo.

**Use with other cameras:** The 35mm—75mm Auto Focus Lens may also be used as a standard non auto-focus zoom lens with all other 35mm Pentax cameras featuring the standard Pentax Bayonet Mount. In this instance, set the power switch to OFF and focus in the conventional manner.

**BATTERIES:** Sufficient voltage is needed for complete auto focus. When the lens no longer rotates on pressing the focusing button, the batteries are depleted. The lens can still be focused with the TTL Electronic Focusing System or manually, but for complete auto focus replace all four batteries immediately. (For TTL Electronic Focus, see page 30, for manual focus — page 38).

**Lens Batteries:** Battery life will vary from a short time to several months depending upon frequency of operation of the lens. Should batteries require replacement, replace all four with equivalent AAA-size alkaline or manganese batteries. Do not mix brands and types, or old and new batteries (this is dangerous and could actually shorten battery life).

**Camera Batteries:** Auto Focus is also no longer possible when camera battery voltage is insufficient for the focusing LEDs to light. For continued auto focus in this instance replace **all four** batteries together with equivalent silver-oxide batteries; do not use alkaline batteries or mix battery brands and types (See "Battery care," page 11).

**Power Switch:** The power switch can be left on while using the lens. When inserting the lens in its case or storing, however, set the switch to OFF. Also set the switch to off and remove batteries when not using the lens for an extended period of time.

## PRECAUTIONS

**Auto Focus Contacts:** Be sure to keep the auto focus contacts of both the camera body mount and lens mount clean; wipe occasionally with a dry cloth to keep them from becoming oily.

**Tripod:** Depending upon the size of the tripod seat, the lens cannot be used with some tripods at the 70mm focal length setting because the battery compartment will hit against the tripod.

**Winder:** When using a winder with the auto focus lens, use only the single-frame mode; in the continuous mode with moving subjects, focus will be correct only for the first frame.



### AF ZOOM LENS FRONT CASE ①

A specially designed case for carrying the 35mm-75mm Zoom Lens together with the ME-F (Optional).

### AF ZOOM LENS CASE ②

Case for carrying the AF 35mm-70mm zoom lens separately (optional).

### LENS HOOD ③

An exclusive lens hood which screw to the threads on the front of the lens. (Optional)

### FILTERS ④

Standard 58mm screw-in and 58mm SMC Pentax screw-in type filters are used in conjunction with your lens; with certain dark black and white filters, manual focus is required.



## TTL ELECTRONIC FOCUS

If you are using the ME-F with regular SMC Pentax lenses (both bayonet K-mount lenses and screw-mount lenses with mount adapter K), you can enjoy the benefit of the camera's built-in electronic focusing system. When used with any of over 30 regular SMC Pentax lenses, this system provides you with electronic focus guidance whereby you can obtain correct focus by simply turning the barrel in the direction of the arrow inside the viewfinder until the large LED correct focus indicator informs you that focus is correct. Moreover, the system is extremely accurate and can be used outdoors in almost all daylight shooting situations, or indoors in well lit rooms. Be sure to read the instructions carefully so that focusing will become as easy and simple as possible.

**To engage the electronic focusing system:** Switch the electro-focus selector on top of the camera to the maximum aperture setting of your lens as indicated below.

■ **~2.8:** Use this setting for all lenses with a maximum aperture of  $f/2.8$  or larger ( $f/2$ ,  $1.7$ ,  $1.2$  etc.). This includes standard lenses, wide angles, zooms and short telephoto lenses.

■ **3.5~:** Use this setting for lenses having a maximum aperture of  $f/3.5$  to  $f/5.6$ . This includes, wide angle, zooms, telephotos, macro and bellows lenses.

**THE OFF POSITION:** The electronic focusing system doesn't apply to lenses having a maximum aperture of  $f/5.6$  or smaller. When using these lenses, set the focus switch to OFF and focus in the conventional manner with the viewfinder focusing screen (See page 38).

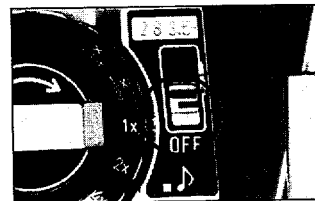
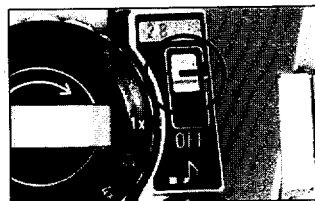





### To focus:

1. Set the shutter mode dial to "Auto." (other settings except B also can be used).
2. Look through the viewfinder and center your subject the split-image center spot. Make sure the points of highest contrast bisect the split-image line.
3. Press the shutter button down partway. The bottom center viewfinder display will light, and the audio focus indicator will give a short "bleep" when on. This means the electronic focusing system is ready.

The viewfinder display will show you one of three possible signals.

	ONE ARROW: Focus the lens in the direction of the arrow.
	TWO ARROWS: Lighting is insufficient or contrast is too flat or extreme for auto focus—focus manually.
	GREEN LIGHT (LED): Subject is in focus; make exposure reading and take picture.
TO FOCUS, SIMPLY TURN THE LENS IN THE DIRECTION OF THE ARROW; WHEN THE GREEN LIGHT SHOWS, TAKE THE PHOTO.	

**NOTE:** *The subject doesn't have to be aligned precisely in the split-image for correct focus with the electronic focus system.*



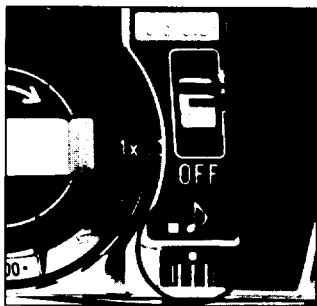

**Audio Focus Indication:** The ME-F provides you with an audible signal which accompanies the LED correct focus indicator. This signal tells you when to take the picture. To operate the audio focus indicator, set the audio focus switch to the musical note. When not needed, turn the audio focus indicator off simply by sliding the switch from the musical note back to the black square.

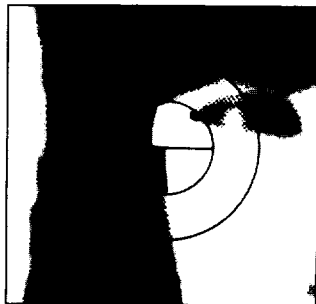

**Hints for good results:** Your ME-F's TTL electronic focusing system will give you perfectly focused photos when used properly. For best results, be sure to place the highest contrast portion of the subject in the split-image center spot. For example, if photographing a person, focus on his or her silhouette as it stands out from the background. For close-up portraits, focus on facial details.

**Foreground Information:** The TTL electronic focusing system focuses for the object in the center of the viewfinder that is closest to the camera. For this reason, make sure that objects in front of your key subject do not cross the split-image center line. Correct focus will be obtained even with foreground objects as long as they do not cross the split-image center line.

**Picture Composition:** When composing a picture, first focus on the key subject. Remember, the focusing system reads only the subject which bisects the split-image line of the viewfinder, so keep the subject in the center until you have finished focusing, then frame as you like.

**Zoom Lenses:** The best way to focus with a zoom lens is at the maximum focal length setting, then frame as you like. This way distracting foreground matter can be easily eliminated.





### **On some occasions you will have to focus manually**

While your auto focus system is extremely accurate, there will be occasions when you will have to focus manually. When this occurs, both LED arrows will light (or flash depending on lighting conditions), informing you to focus in the conventional manner as indicated on page 38.

These situations arise mainly when lighting is insufficient or contrast is too flat for the sensor to read the subject. Examples include photographing indoors in dimly lit room, outdoors at dawn, twilight or in heavy shade or overcast. (EV 4, at ASA 100, 1 sec. at f/4).

Subjects without contrast, such as a white wall also present a problem, as do excessively bright subjects, strong backlighting, fast moving subjects, very fine patterns or lines and subjects with extreme contrast (over EV 16 at ASA 100, 1/125 sec. at f/22).

**Note:** Even with subjects lacking contrast, the system can sometimes be made to work if some mark or distinguishing feature of the subject can be placed in the center spot of the viewfinder, such as the bicycle tire in the top photo.

**When both LEDs light continuously, you must focus manually.  
Lighting or contrast is insufficient for Electronic Focus.**



**Special Purpose Photography:** The TTL electronic focus is also convenient for a wide range of special-purpose applications such as close-ups, macrophotography, photography with a microscope, or with shift or bellows lenses. In many of these instances, you can focus in the normal manner as described above.

With bellows and lens extension accessories, however, the exposure factor will make the lens aperture smaller. Be sure to take this into account when you set the electro focus selector.

Although most standard filters can be used with the lens, with dark black and white filters you should focus manually; also for regular polarizing filters.



**Battery Check:** Battery voltage is adequate for correct focus with the TTL Electronic Focusing System as long as the LED focusing display inside the viewfinder lights. When the LEDs no longer light, voltage is insufficient for electronic focusing.

If continued use of the electronic focus system is desired, replace all four batteries together. Do not mix battery brands or types; this could actually shorten battery life and is dangerous.

**NOTE:** Battery voltage will be adequate for normal "Auto" or electronic manual exposures for a considerable time after voltage is no longer sufficient for electronic focusing. Exposure can be made in the normal manner without TTL electronic focus (See page 38).

**IMPORTANT:** Always set the electro-focus selector to OFF when the electronic focusing system is not in use to ensure longer battery life.

## MANUAL FOCUS

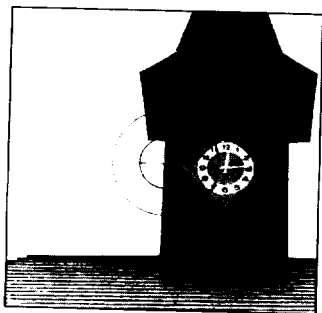

The ME-F comes equipped with a split-image/microprism focusing screen which provides a split-image center spot surrounded by a microprism collar on a matte field. For situations where the TTL electronic focusing system does not apply you can focus manually using all three areas of the focusing screen.

**To focus with the split-image center spot:** simply turn the lens focusing ring until the broken image in the center spot of the viewfinder aligns as one.

**To focus with the microprism collar:** When using the microprism collar surrounding the center spot, rotate the lens focusing ring until the "shimmering" effect in the collar area seems to disappear.

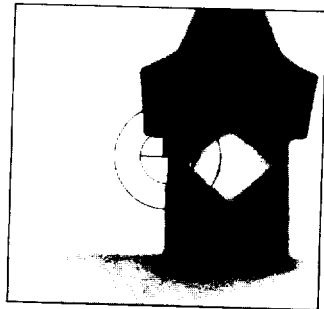

**The matte field:** This is quite handy for focusing with long telephoto lenses having small apertures to which electronic focusing doesn't apply. To focus, turn the focusing ring of the lens until the image on the matte field appears sharp and crisp.

## EXPOSURES ON AUTO

In the "Auto" exposure mode the camera automatically varies the shutter speed in relation to the preset lens aperture. In most cases, sharply focused, well-exposed photos are easily obtained simply by presetting the camera as outlined below. When it is very bright, however, or when lighting is limited, such as at dusk, dawn, night, indoors, etc.), some additional adjustments may be required. Usually, it is sufficient to change the lens aperture, but there will also be instances when use of a tripod, electronic flash, or the exposure compensation dial will bring improved results.

**For exposures on "Auto"** perform the following:

- Check that the film speed is set properly (page 15).
- Check that the exposure compensation dial is set to 1X.

(1) Set the shutter mode dial to "AUTO."

(2) Preset the lens aperture according to lighting conditions.

**Exposure Check:** Look through the viewfinder and lightly press the shutter button; the LED (light-emitting-diode) shutter speed display on the left-hand side of the viewfinder will light. (The display shuts off automatically 10 seconds after you release your finger from the shutter button).

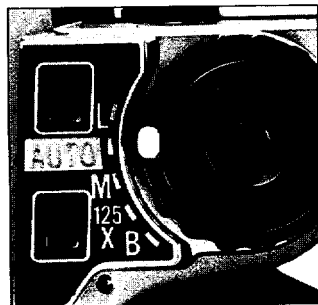

The figures seen in the viewfinder from "2" to "2000" refer to the shutter speeds in fractions of seconds (i.e., 1/2 sec. to 1/2000 sec.), "1" to "4S" indicate full-second shutter speeds.

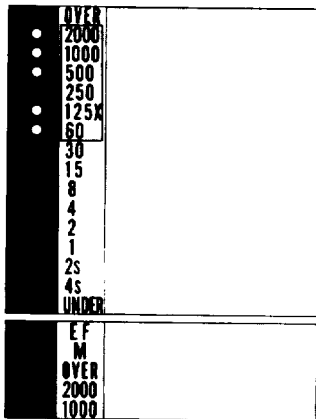

#### **GREEN LED – CORRECT EXPOSURE “Go ahead and shoot”**

If one of the GREEN LEDs light (i.e., those between "2000" and "60," no further adjustments are required. Simply focus, compose your picture and shoot by pressing the shutter button all the way down. A GREEN LED indicates that the shutter speed is fast enough to shoot while holding the camera in your hand.

#### **RED “OVER” LED – OVEREXPOSURE**

If the RED LED beside the "OVER" indication at the top of the shutter speed scale lights, your shot will be overexposed unless you adjust the lens aperture ring. To correct for overexposure, turn the aperture ring clockwise to a smaller aperture (i.e., f/5.6 to f/8, f/11, etc.) until one of the GREEN LEDs light. It is not necessary to stop when the LED lights at "2000" (when more depth-of-field is desired, use a slower shutter speed and smaller lens aperture — see page 54).

**CAUTION:** If you should happen to press the shutter button while the shutter dial is set on AUTO with the lens cap on, or in very poor lighting conditions, the mirror may lock up, resulting in abnormally long exposure. To correct this, the shutter can be quickly closed by turning the shutter dial to 125X. After closing the shutter, be sure to reset the shutter dial to AUTO.

### YELLOW LED – SLOW EXPOSURE/CAMERA SHAKE WARNING

When the shutter speed drops below 1/60 sec., although exposure will be correct, the slightest movement of the camera – even vibration from pressing the shutter button – often produces “camera shake” at the critical moment of exposure; this in turn will cause blurred pictures. The LEDs between “30” and “4S” illuminate in yellow to warn against camera shake. If a YELLOW LED lights, first try a wider lens aperture (i.e., f/5.6 to f/2.8, f/1.7, etc.) to see if a GREEN LED will appear. If the GREEN LED doesn’t light before you reach the widest lens aperture, do either of the following: ① Shoot at the fastest possible shutter speed indicated by a YELLOW LED, but brace the camera on a firm surface: better still, use a tripod – to minimize camera shake (page 51) or, ② switch to flash (page 52–53).

### RED “UNDER” LED – UNDEREXPOSURE

When light is extremely limited, the RED LED beside the “UNDER” indication at the bottom of the scale glows to warn you against underexposure. If this LED lights, first try setting the lens to its widest aperture (f/2, f/1.4, etc.). If a GREEN LED lights, go ahead and shoot. If a YELLOW LED appears, follow the procedure outlined in “YELLOW LED – SLOW EXPOSURE” above. If the RED “UNDER” LED remains lit even at the widest aperture: ① make a time exposure using a tripod at the “B” mode setting, or ② switch to flash (page 52–53).

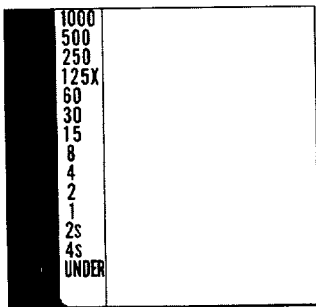
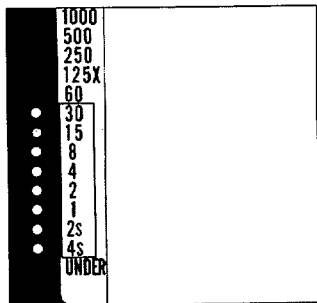

## AUTO EXPOSURE COMPENSATION

In difficult lighting situations where there is an extreme contrast between the subject and the background, the auto exposure system tends either to over or underexpose the subject somewhat, which results in the loss of detail. To compensate for such situations, your ME F is provided with an exposure compensation dial which overrides the influence of the adverse lighting source.

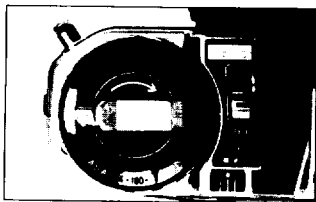

The dial surrounds the film rewind crank and is scaled 4X, 2X, 1X, 1/2X and 1/4X (X indicates the exposure increase or decrease factor).

**“Normal Exposure”** is obtained at the 1X setting. Always keep the dial at this setting when exposure compensation is not needed.

**Exposure Increase:** At the 2X and 4X settings the camera is programmed automatically to double and quadruple the light reaching the film.

**Exposure Decrease:** Conversely, at the 1/2X and 1/4X settings, one-half and one-fourth the amount of light is delivered to the film.

**To set the Dial:** Place your fingers on the outer rim of the dial and turn it until the figure representing the amount of compensation required aligns with the orange index pointer. When exposure compensation is employed, the red LED beside the “EF” indication at the top of the viewfinder scale will flash when you activate the exposure meter to warn that an “exposure factor” is being employed.

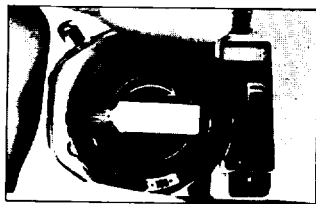

**Compensation for Backlit Subjects:** For subjects with the sun behind them, or against a bright snowy background, brightly lit window, etc., increase the exposure by setting the dial either to 2X or 4X. (Use your own judgement of the brightness of the scene in determining which factor to use).

**Compensation for Spotlit Subjects:** When the subject is spotlighted on stage, etc., or for any intensely lit subject against a dark background, decrease the exposure by setting the dial to 1/2X or 1/4X to help bring out the details of the subject.

**ALWAYS SET THE EXPOSURE COMPENSATION DIAL BACK TO 1X WHEN COMPENSATION IS NO LONGER REQUIRED.**



compensated

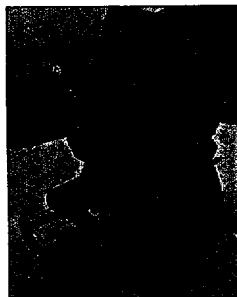

uncompensated



## MANUAL EXPOSURES

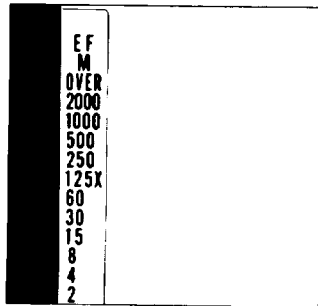
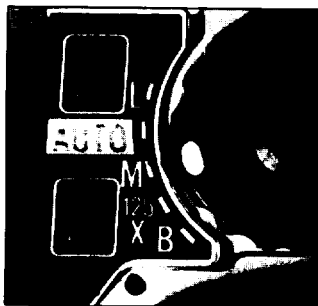

While the shutter speed in the "AUTO" mode varies continuously in relation to lighting conditions, the ME-F revolutionary new "pushbutton" manual exposure system lets you freeze the shutter speed at any one of the 14 LED shutter speed settings displayed inside the viewfinder—a handy feature for fast moving subjects and other special exposure situations. To select the manual shutter speed, just turn the exposure mode dial to "M," activate the exposure meter and press either the shutter speed increase or decrease button. As shutter speed setting is done completely with the eye to the viewfinder, the fumbling characteristic of the traditional shutter speed dial has been eliminated.

**Exposure Metering:** After setting the exposure mode dial to "M," depress the shutter button lightly. This activates the meter and lights the LED shutter speed display inside the viewfinder. As with auto exposures, the display remains lit for approx 10 sec. and goes out. If additional metering time is required, simply press the shutter button lightly once again.

**Manual Shutter Speed Indication:** Each time you activate the meter while operating in the manual mode, the "M" (manual) indicator lights as a reminder that you are making manual exposures. In addition, the shutter speed to which the system was set prior to activating the meter will also light (even when you turn the mode dial away from the "M" setting, the manual exposure memory circuit displays your previous manual shutter speed when you reactivate the meter on switching back to "M").



### Shutter Speed Control Pushbuttons

Two shutter speed control pushbuttons are provided to enable rapid shutter speed selection in the manual mode. These operate when the exposure mode dial is set to "M" (manual) and the shutter release button is partially depressed to light the LED display inside the viewfinder.

### Shutter Speed Increase — Forward Button

Press the forward button and the LED shutter speeds inside the viewfinder will increase from bottom to top. Let go of the button when the LED lights beside the desired shutter speed. When the display reaches "2000" at the top of the scale, it starts over from the bottom (for example: 1000 — 2000 — 4S — 2S — 1 — 2 . . . . 500 — 1000 — 2000 — 4S — 2S, etc.).

### Shutter Speed Decrease — Rear Button

Press this button and the LED shutter speed display decreases from top to bottom. At the bottom of the scale, the display starts over again at the top (thus: 2S — 4S — 2000 — 1000 . . . . 15 — 8 — 4 — 2 — 1 — 2S — 4S — 2000, etc.).

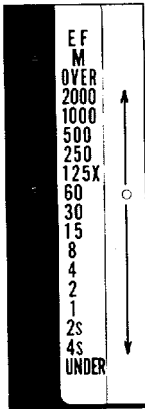
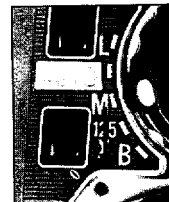
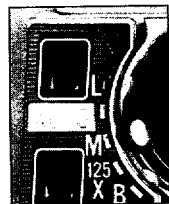
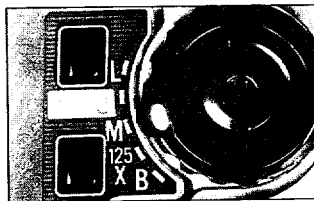

**EXPOSURE SETTING:** With the manual exposure system you have the option of setting either the shutter speed or the lens aperture first. The "OVER" and "UNDER" LEDs flash in the viewfinder to serve as guides for setting the correct exposure.

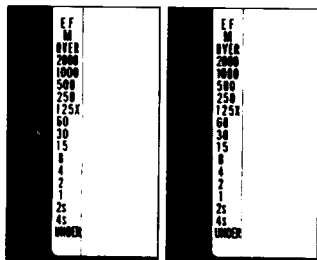

**Shutter Speed First:** Set the desired shutter speed with the shutter speed control pushbuttons. If the "OVER" LED still flashes, stop the lens down to a smaller aperture (i.e.,  $f/5.6$  to  $f/11$ ,  $f/16$ , etc.) until it goes out. If the "UNDER" LED remains lit, set the lens to a wider aperture (i.e.,  $f/5.6$  to  $f/2$ ,  $f/1.4$ , etc.). Exposure is correct when the shutter speed and the "M" LED are the only LEDs that remain lit in the viewfinder.

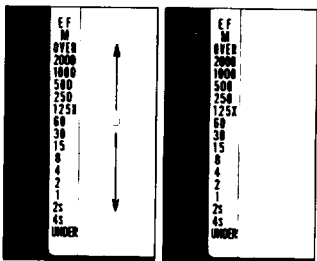

**Aperture First:** Set the  $f$ -number you wish to shoot at with the aperture control ring, then match up the shutter speed with the shutter speed control pushbuttons. When the "OVER" LED is lit, increase the shutter speed until it goes out. When the "UNDER" LED is lit, decrease the shutter speed until the "UNDER" indication goes out.

Exposure is correct when the shutter speed and the "M" LED are the only LEDs that remain lit in the viewfinder.

**Overexposure:** If the "OVER" LED fails to go out when you set the exposure by presetting the shutter speed, use a faster shutter speed; conversely, if it remains lit when you preset the lens aperture, use a smaller aperture.

**Low-Light Exposures/Underexposure:** With either method, when exposure conditions require that you use a slow shutter speed below 1/60 sec., be sure to take precautions against camera shake. If the underexposure LED remains lit even after you have given maximum exposure, either make a time exposure at the "B" setting (page 51), or switch to flash photography (pages 52–53.)



#### NOTE

**Shortcut:** When changing from a slow to a fast shutter speed, it is not necessary to use the shutter speed increase button. If the given shutter speed is 2 sec. and you desire to increase to 1/1000 sec., for example, simply press the decrease button until the LED lights at "1000." (When going from a fast to a slow shutter speed, reverse the procedure by taking a shortcut with the shutter speed increase button).

## HOLDING THE CAMERA

As a general rule, your camera can be held more firmly in the left hand, which does not release the shutter. If you hold your camera with the right hand — the hand that releases the shutter — this may cause camera movement. Often, blurred pictures are due to camera movement.

### Horizontal position A.

Hold the camera firmly with your left hand, and draw your arms close to your body.



### Vertical position B.

Hold your camera tightly to your forehead with your left hand, and draw your right arm close to your body.



### Vertical position C.

Hold your camera tightly to your forehead with your left hand, raise your right arm and draw your left arm to your body.



## UNLOADING THE FILM

After the last picture on the roll has been taken, the rapid-wind lever will not advance any further (Caution: do not try to force the lever), indicating that the film must be rewound. Lift up the rewind crank. Depress the film rewind button **A** and turn the rewind crank as indicated to rewind the film into its cartridge. If the film is being properly rewound, the film rewind indicator **B** will flicker. Rewind until the tension on the crank lessens, indicating that the leader end of the film has been released from the take-up spool. Pull out the film rewind knob (the back will open automatically), and remove the film cartridge.

AVOID DIRECT LIGHT WHEN UNLOADING THE FILM.

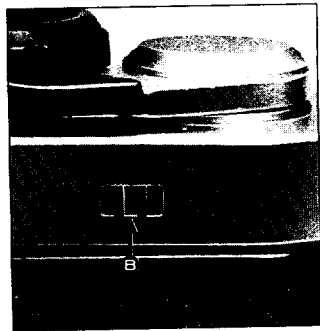
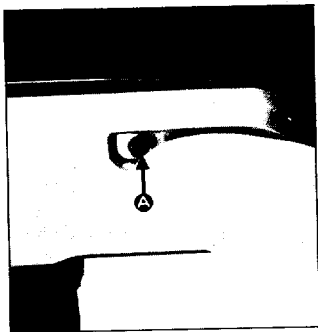

## SELF-TIMER/MULTIPLE EXPOSURES

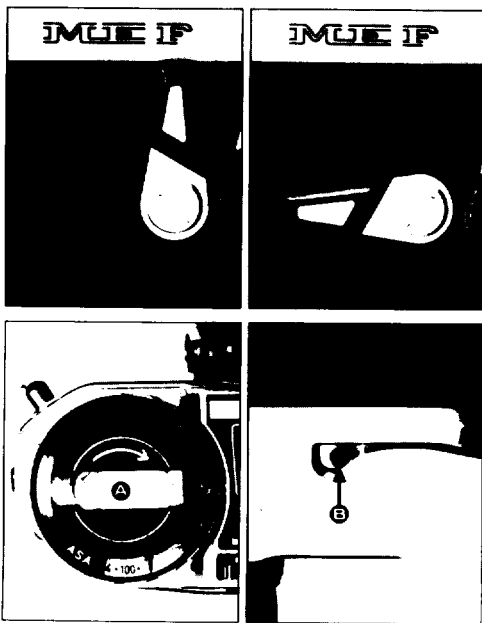

### Self-Timer

The self-timer delays release of the shutter 4 – 10 sec., depending upon how far the self-timer lever is advanced. To operate the self-timer, push the lever counterclockwise until it stops. To start, push up slightly on the self-timer lever. Note: Cover the viewfinder eyepiece with the accessory Finder Cap when using the self-timer; otherwise, light entering from the rear of the camera may adversely affect the exposure.

### Multiple Exposures

For deliberate multiple exposures, make the first exposure in the normal way. Then tighten the film by turning the rewind knob **A**, and keep hold of the rewind knob. Depress the film rewind button **B** and advance the rapid-wind lever. This cocks the shutter without advancing the film. Finally, release the shutter to make the second exposure. Then make one blank exposure, before taking the next picture, to avoid overlapping. As the exposure counter continues to function each time the shutter is cocked, a double exposure will be counted as two frames.

## USING A TRIPOD/TIME EXPOSURES AT "B"

### Using a Tripod

The camera may be mounted directly to a tripod by screwing the tripod into the socket at the base of the camera. Be sure the tripod screw protrudes no more than 5.5mm (0.22 in.) from the tripod. This is the depth of your camera's tripod socket. Don't use a longer screw as it may puncture the bottom of the tripod socket if tightened too firmly.

**Finder Cap:** When you make exposures with your eye away from the viewfinder while using a tripod (or at any other time), cover the viewfinder eyepiece with the accessory Finder Cap; otherwise, light entering from the rear may adversely affect the exposure.

### Time Exposures at "B"

Exposures longer than 4 sec. exceed the range of the camera's electronic shutter and must be made at the "B" setting of the exposure mode dial. Here the shutter remains opened as long as the shutter release button is held depressed. To prevent movement of the camera during exposure, mount it on a tripod and attach a cable release to the hole in the shutter button to release the shutter. For exposures lasting several minutes or hours, use a cable release with a locking device.

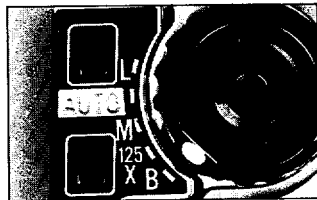
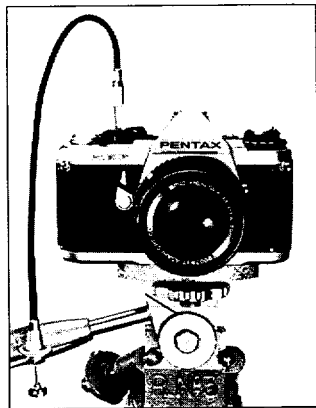

## FLASH PHOTOGRAPHY (With Pentax Dedicated Flash Units)

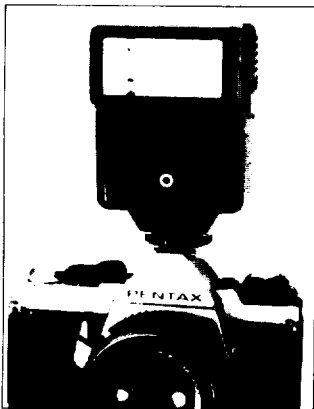

When used with any one of the Pentax "Dedicated" Automatic Flash Units,\* your ME-F offers the convenience of "dedicated" flash—automatic synchronization for flash on charging and flash ready indication right inside the viewfinder.

**For Dedicated Auto Flash:** Leave the shutter mode dial of the camera set at "Auto" or "M", and attach the flash to the camera hotshoe. Set the flash mode in accordance with the instructions provided with the unit and switch the flash on. When the unit charges, the camera synchronizes automatically for flash at 1/125 second; in addition, the green "M" and "125X" LEDs will flash inside the viewfinder signaling that the flash is ready. After taking your photo, the camera reverts to the non-flash exposure mode in use until the unit has recycled. To cancel the flash exposure, simply switch the flash unit off.

\*Presently four of these are available—AF-200S, AF-160, AF-280T and AF080C Ring Light.

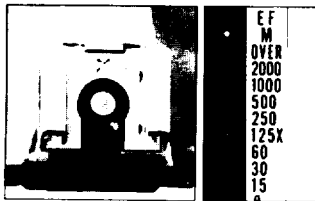



## OTHER FLASH UNITS

The ME-F may also be used with a variety of other flash units, including both hotshoe type units and bracket-mount type requiring cord hook up. If your flash is the hotshoe type it synchronizes directly via the hotshoe.

If it requires cord hook up, plug the cord into the "X" synch terminal beside the lens mount.

**For Flash Operation:** Synchronize the unit manually for flash by pressing the white button and setting the shutter mode dial to "125X." Then, set the flash exposure as indicated in the instruction manual accompanying your flash unit.

**NOTE:** Viewfinder flash synchronization and flash ready indication are not given when the manual "125X" setting is used.  
**IMPORTANT:** Use of dedicated flash units other than Pentax brand may damage the camera's electronic circuitry and precaution should be taken. Also, when using the Pentax Superlite II, synchronize for flash at the mechanical 125X shutter speed setting only.

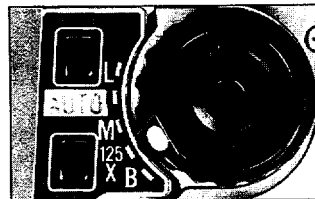
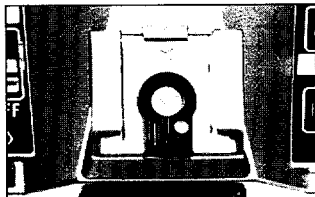

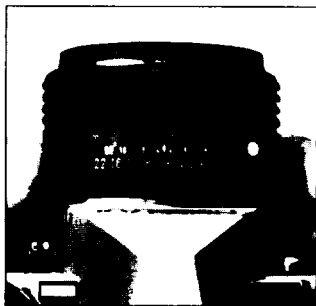

The tri-colored viewfinder indications of your ME-F's automatic exposure system and the electronic focusing make it extremely easy to obtain good results in a wide variety of shooting situations. However, there are also a few basic aperture and shutter speed control techniques which are handy in order to obtain good results with moving subjects, creating interesting effects, and so forth. If SLR photography is relatively new to you, it will certainly be worthwhile to take the time to learn these few basic techniques.

### **Optimum Apertures**

The aperture guide listed on page 18 is sufficient for almost all shooting purposes and correct exposure will be obtained as long as one of the green shutter speed LEDs light. However, you may add more interest to your pictures with certain subjects by varying from the norm. Any aperture setting may be used as long as either a green or yellow LED shutter speed indicator lights (in the case of the latter, provided you take precautions against camera shake).

**Stopping the Action:** With moving subjects such as bicycles, automobiles, horses, children at play, birds in flight, etc., a fast shutter speed is necessary to stop the action and prevent the subject from blurring. With manual exposures, this problem is solved by preselecting a fast shutter speed such as 1/250 sec., 1/500 sec., 1/1000 sec., etc. However, when shooting on "AUTO," you can usually select a shutter speed fast enough to stop the action simply by using a wide lens aperture. As the camera automatically chooses the fastest possible shutter speed for the given exposure, wide apertures

will give you shutter speeds in excess of 1/250 sec. when lighting is sufficient. (NOTE: This technique does not work in low-lighting as low lighting necessitates a slow shutter speed.)

**Depth-of-Field Control:** Depending upon the aperture in use, the over-all sharpness of the picture area in front and behind the subject will vary greatly. This effect is known as "depth of field" and can be used to vary the over-all effect of your photos.

**Maximum Depth of Field:** The depth of field becomes progressively deeper as the lens is stopped down to smaller lens apertures and is greatest at minimum aperture. Thus, if you desire to have both your subject and the background in focus, use a small aperture such as f/11 or f/16 (be sure to take precautions against camera shake if a yellow LED lights). Small apertures are also useful for critical close-up work, but for this, refer to a close-up photography guide.

**Out-of-Focus Highlights:** The depth of field becomes progressively shallower at wide lens apertures, and is shallowest at f/2, f/1.7 or f/1.4, depending upon which is the maximum aperture of your lens. A shallow depth of field produces an out-of-focus effect which highlights your subject. As long as the LED does not light at the "OVER" setting, you can obtain this effect, even on a bright, sunny day, by using a wide maximum aperture.

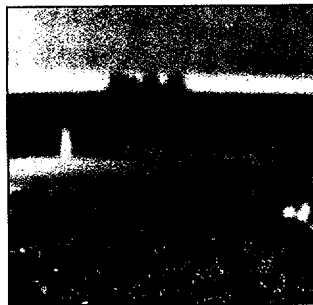
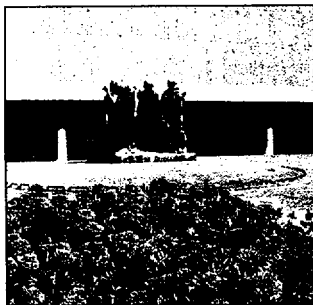

## DEPTH-OF-FIELD SCALE

Depth of field is the range between the nearest and farthest distances which are in focus at a given lens aperture.

If you want to know how great the depth of field is at a certain aperture, focus on the subject and look at the depth-of-field scale on the lens. In the photograph below the distance scale is set at 5 meters; that is, the lens is focused on a subject 5 meters away. The calibrations on each side of the distance index correspond to the diaphragm setting and indicate the range of in-focus distance for different lens apertures.

For example, if a lens opening of  $f/4$  is to be used, the range on the distance scale ring covered within the figure 4 on the depth-of-field scale indicates the area in focus at that lens opening. You will note from the depth-of-field scale in the photograph that the range from approximately 4 to 7m is in focus. Note that as the lens apertures change, the effective depth of field also changes. For the depth of field at different apertures and distances, refer to the next page.

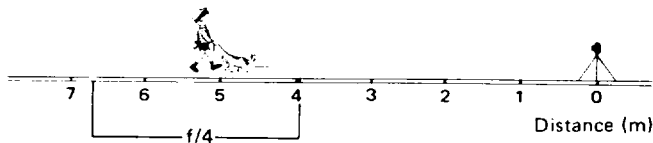
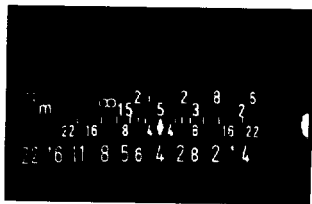

# DEPTH-OF-FIELD TABLE: SMC PENTAX-M 50mm LENS

unit=meter

Distance scale	0.45m	0.6m	1m	1.6m	2m	3m	5m	15m	∞
f/1.4	0.447 ~ 0.453	0.595 ~ 0.605	0.984 ~ 1.017	1.557 ~ 1.645	1.932 ~ 2.073	2.846 ~ 3.172	4.579 ~ 5.506	11.712 ~ 20.868	52.938 ~ ∞
f/2	0.446 ~ 0.454	0.593 ~ 0.608	0.977 ~ 1.024	1.539 ~ 1.666	1.904 ~ 2.106	2.785 ~ 3.252	4.420 ~ 5.757	10.707 ~ 25.077	37.070 ~ ∞
f/2.8	0.445 ~ 0.455	0.590 ~ 0.611	0.969 ~ 1.034	1.516 ~ 1.694	1.869 ~ 2.152	2.708 ~ 3.365	4.225 ~ 6.128	9.609 ~ 34.313	26.491 ~ ∞
f/4	0.443 ~ 0.458	0.586 ~ 0.615	0.956 ~ 1.049	1.483 ~ 1.737	1.818 ~ 2.224	2.599 ~ 3.550	3.962 ~ 6.786	8.329 ~ 76.783	18.557 ~ ∞
f/5.6	0.440 ~ 0.461	0.580 ~ 0.622	0.939 ~ 1.070	1.441 ~ 1.799	1.754 ~ 2.329	2.468 ~ 3.832	3.659 ~ 7.922	7.075 ~ ∞	13.268 ~ ∞
f/8	0.436 ~ 0.466	0.572 ~ 0.631	0.915 ~ 1.103	1.383 ~ 1.901	1.667 ~ 2.506	2.294 ~ 4.351	3.284 ~ 10.585	5.774 ~ ∞	9.300 ~ ∞
f/11	0.430 ~ 0.472	0.562 ~ 0.644	0.887 ~ 1.148	1.316 ~ 2.047	1.569 ~ 2.771	2.109 ~ 5.242	2.911 ~ 15.301	4.697 ~ ∞	6.776 ~ ∞
f/16	0.422 ~ 0.482	0.546 ~ 0.667	0.844 ~ 1.231	1.219 ~ 2.348	1.430 ~ 3.386	1.861 ~ 7.978	2.450 ~ ∞	3.588 ~ ∞	4.672 ~ ∞
f/22	0.413 ~ 0.496	0.529 ~ 0.696	0.798 ~ 1.349	1.120 ~ 2.855	1.294 ~ 4.545	1.631 ~ 21.588	2.061 ~ ∞	2.799 ~ ∞	3.410 ~ ∞

unit=feet

Distance scale	1.55'	1.9'	2.5'	3'	6'	8'	12'	25'	∞
f/1.4	1.540' ~ 1.560'	1.884' ~ 1.916'	2.471' ~ 2.530'	2.957' ~ 3.045'	5.814' ~ 6.198'	7.667' ~ 8.364'	11.252' ~ 12.896'	21.905' ~ 29.122'	173.686' ~ ∞
f/2	1.536' ~ 1.564'	1.878' ~ 1.923'	2.459' ~ 2.543'	2.939' ~ 3.064'	5.738' ~ 6.287'	7.533' ~ 8.530'	10.960' ~ 13.262'	20.802' ~ 31.339'	121.623' ~ ∞
f/2.8	1.531' ~ 1.570'	1.869' ~ 1.932'	2.443' ~ 2.560'	2.915' ~ 3.091'	5.640' ~ 6.410'	7.361' ~ 8.763'	10.593' ~ 13.845'	19.495' ~ 34.884'	86.915' ~ ∞
f/4	1.523' ~ 1.573'	1.856' ~ 1.946'	2.419' ~ 2.587'	2.880' ~ 3.131'	5.499' ~ 6.604'	7.118' ~ 9.137'	10.087' ~ 14.824'	17.817' ~ 42.020'	60.884' ~ ∞
f/5.6	1.512' ~ 1.590'	1.839' ~ 1.965'	2.388' ~ 2.624'	2.835' ~ 3.187'	5.322' ~ 6.882'	6.818' ~ 9.690'	9.485' ~ 16.370'	15.986' ~ 57.817'	43.530' ~ ∞
f/8	1.497' ~ 1.608'	1.815' ~ 1.995'	2.343' ~ 2.681'	2.769' ~ 3.275'	5.078' ~ 7.347'	6.414' ~ 10.660'	8.706' ~ 19.414'	13.855' ~ 132.990'	30.514' ~ ∞
f/11	1.478' ~ 1.631'	1.785' ~ 2.033'	2.290' ~ 2.756'	2.692' ~ 3.393'	4.802' ~ 8.027'	5.973' ~ 12.190'	7.898' ~ 25.319'	11.882' ~ ∞	22.231' ~ ∞
f/16	1.447' ~ 1.670'	2.101' ~ 1.737'	2.206' ~ 2.892'	2.573' ~ 3.609'	4.406' ~ 9.500'	5.361' ~ 16.047'	6.845' ~ 51.597'	9.611' ~ ∞	15.329' ~ ∞
f/22	1.413' ~ 1.721'	1.684' ~ 2.188'	2.114' ~ 3.075'	2.445' ~ 3.911'	4.012' ~ 12.205'	4.778' ~ 25.969'	5.906' ~ ∞	7.827' ~ ∞	11.188' ~ ∞

## USING SCREW-MOUNT TAKUMAR LENSES

Conventional screw-mount Takumar lenses (both Super-Takumar and SMC Takumar) can be easily mounted onto your camera by attaching them first to the Mount Adaptor K. However, when Adaptor K is used, the following is true.

- \* Due to the difference in coupling systems, the automatic diaphragm will not function.
- \* Full-aperture metering lenses will function as stop-down metering lenses.

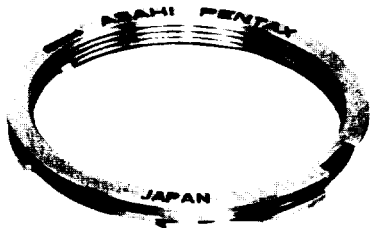

### How to Use Mount Adaptor K

1. Screw the conventional Takumar lens into the Mount Adaptor K.

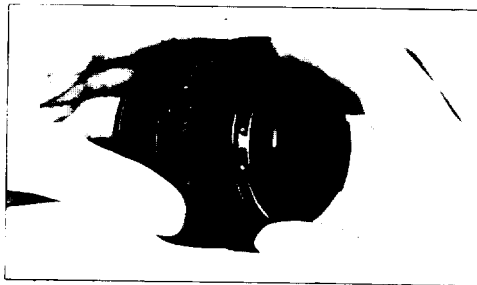

2. Attach the Adapter/lens unit to the camera body by aligning the red dots **A** and **B**, and turning the lens clockwise until it locks with a click. (This takes slightly less than a quarter of a revolution.)
3. To remove the lens, leaving the Mount Adapter K attached to the camera body, simply unscrew the lens counterclockwise. Other screw-mount Takumar lenses can then be attached in the normal way.

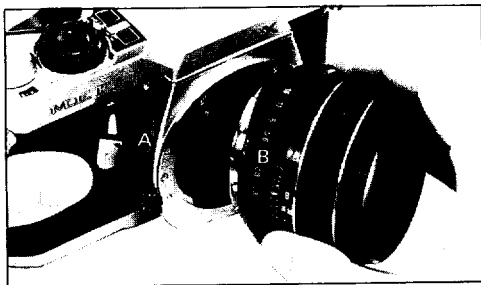

1. To remove the Mount Adaptor K from the camera body, first remove the screw-mount lens. Then press, with your thumbnail or a pointed object such as a ballpoint pen, against the spring pin **C**.
2. Turn the Mount Adaptor K counterclockwise until you feel it release, and take it out.
3. Since the mechanism for locking in the Mount Adaptor K is totally different from that which locks in an SMC Pentax bayonet-mount lens, the lens release lever **D** on the camera body plays no part at all.

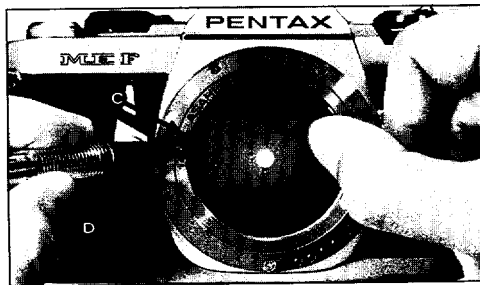

## INFRARED PHOTOGRAPHY

If you intend to take infrared photographs, remember to use the infrared mark indicated with an orange line on the depth-of-field scale. First, bring your subject into sharp focus. Next, determine the subject-to-camera distance from the distance scale on the lens. Then match your subject-to-camera distance to the infrared mark by turning the focusing ring accordingly. For instance, if your subject is in focus at infinity, turn the focusing ring and move the infinity ( $\infty$ ) mark to the infrared mark.

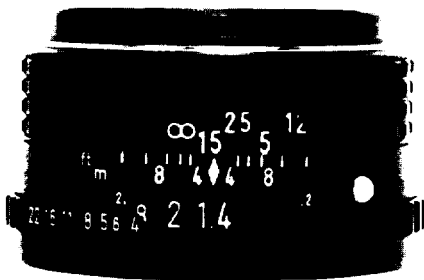
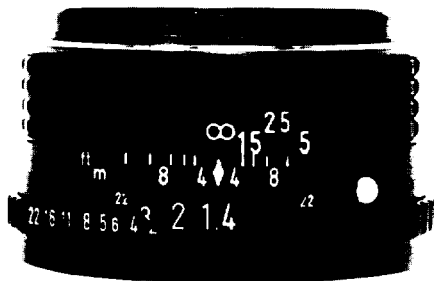

• NOTE: An infrared focusing adjustment is not required when working with infrared color film.



## OPEN-APERTURE AND STOP-DOWN METERING LENSES

Open-aperture SMC Pentax lenses have a diaphragm coupling lever **A** on the back of the lens which couples with the camera body to permit open-aperture metering. The ultra telephotos do not have a diaphragm coupler, so they must be used with the stop-down metering system. Use of the Auto-Extension Tube Set K permits open-aperture metering. Use of other K Series accessories — standard Extension Tube Set K, Helicoid Extension Tube K, Auto-Bellows M and Bellows Unit III — requires stop-down metering. Whenever any one of these is used between the camera body and an SMC Pentax lens, the stop-down metering system must be used.

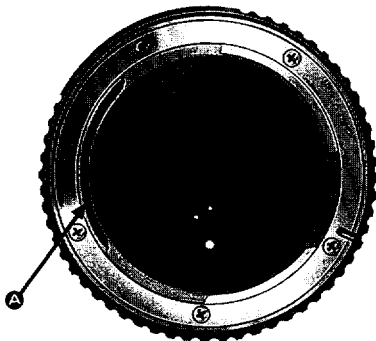

## CAMERA MAINTENANCE

### CLEANING:

- Always keep the viewfinder eyepiece, lens and filters as clean as possible. To remove loose dust and dirt, first use the blower and then the brush of a lens brush. Do not try to wipe off granular dirt or dust — it's an excellent way of scratching the glass.
- Smudges, such as fingerprints, should be carefully wiped away with either lens tissue or a clean, soft cloth. Clean, plain cotton handkerchiefs that have already been washed a few times are particularly good for this. Breathing on the lens before wiping is effective; but be sure to wipe away all moisture completely. Commercial lens cleaners are also effective.
- Never touch the mirror or the shutter leaves. Minor dirt or spots on the mirror will not affect the clarity of your pictures.
- Take care not to drop the camera or knock it against anything solid. Accidents or rough handling can easily damage the internal mechanism, even though externally nothing seems to have been damaged.

### KEEP YOUR CAMERA DRY:

- Your camera is *not* waterproof. There are several places where water can get inside and do a great deal of damage. Take care to protect both body and lens from rain or splashing water. If your camera should get wet, dry it off immediately with a clean, soft cloth.
- If your camera becomes completely soaked, it may malfunction. In this instance, bring it as soon as possible to an authorized Pentax service center.

### STORAGE:

- Where to keep your camera while you are not using it is an important point. The best storage place is cool, dry, clean and well-ventilated. Because of the possible build up of humidity, it is risky to store your camera in a cabinet or closet. It's also a good idea to keep your camera in its bag or case while you are not using it.

## RESISTANCE TO TEMPERATURE EXTREMES AND CHANGES

The temperature range at which your camera will continue to function properly stretches from 50°C to -20°C. However, resistance to cold could be hampered by dirty oil. Therefore, if the camera is to operate at full efficiency in very cold conditions, it must be overhauled and all oil must be replaced. Sudden changes in temperature will often cause moisture to condense inside or outside your camera. This is a possible source of rust, which may be extremely harmful to the mechanism. Furthermore, if the camera is taken from a warm temperature to a sub-freezing one, further damage may result from the formation of icelets.

Thus, sudden temperature changes should be avoided as much as possible. As a guide, a temperature change of 10°C should be allowed to take place gradually over a period of at least 30 minutes. If this is not possible, keeping the camera in its case or bag will help somewhat in minimizing the effects of a rapid temperature change.

Extremely low temperature reduces the efficiency of the battery. Therefore, the camera should be protected against low temperature. Put the batteries into the camera right before shooting. For extremely low temperature, use new batteries.

## METER COUPLING RANGE

The meter coupling range of your ME-F assures accurate exposure reading over a broad range of shutter speed/film speed combinations.

The working EV range of for both auto and manual exposure systems also varies with the lens in use and is reflected in the chart to the right.

With the SMC Pentax AF zoom with ASA 100 film it extends from EV-1 (f/2.8 at 4 seconds) to EV 19 (f/16 at 1/2000th second; f/22 at 1/1000th second); with the f/1.4 50mm standard lens it runs from EV-1 (f/1.4 at 1 second) to EV-19 (f/16 at 1/2000th second; f/22 at 1/1000th second).

You can calculate what the working EV range would be at other film speeds by mentally adjusting the accurate exposure coupling range. Simply move the ASA arrow at the right of the chart up or down and adjust the chart accordingly. At ASA 50 with the 50mm f/1.4 lens, for example, it would run from EV-0 (f/1.4 at 2 seconds; f/2 at 4 seconds) to EV-18 (f/22 at 1/500th second; f/16 at 1/1000th second).

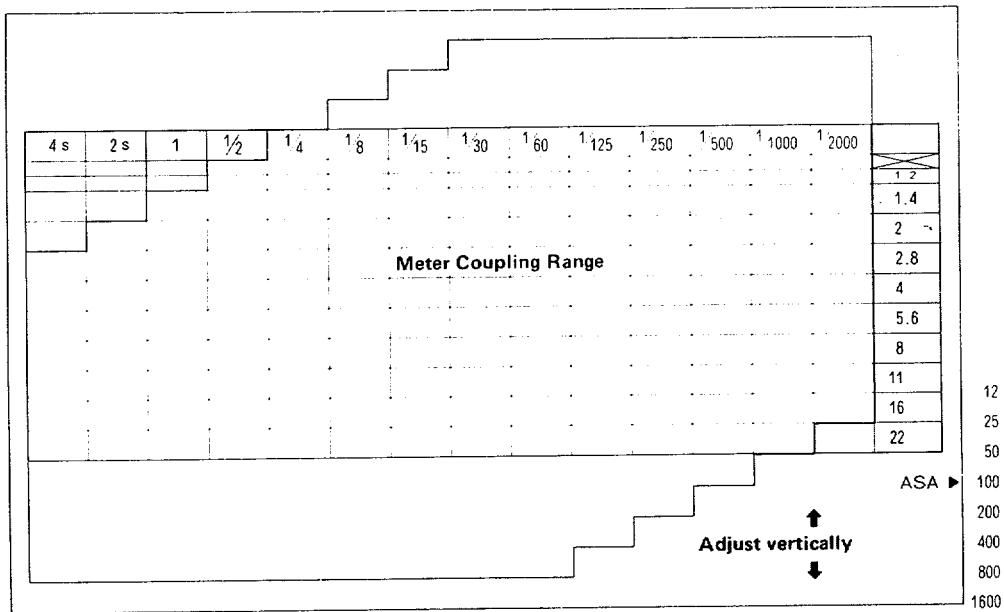

# VIEWFINDER DIAGRAM

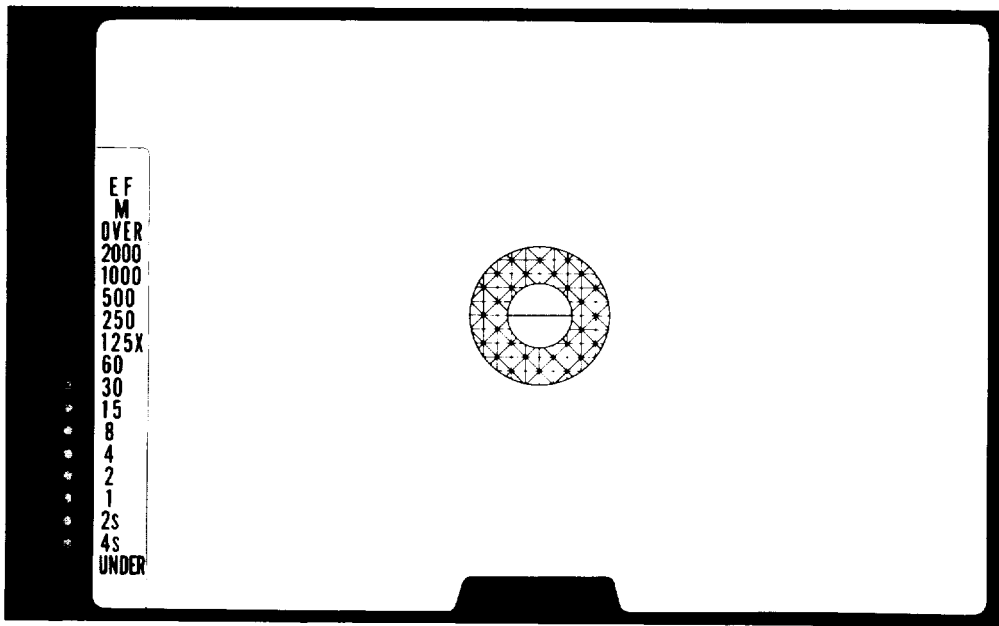

Indication	Color	Function	
EF	RED	Exposure compensation indicator ("EF"=Exposure Factor), flashes red when exposure compensation is employed.	
M	GREEN	(1) Manual Exposure Warning (glows green). (2) Auto Flash Ready Indicator (flashes green when dedicated Auto Flash has charged).	
OVER	RED	Overexposure Warning	
2000	GREEN	1/2000 sec. shutter speed setting	Indications 1/2000 sec. thru 1/60 sec. are given in green to signal adequate speed for handheld shooting.
1000	GREEN	1/1000 sec.	
500	GREEN	1/500 sec.	
250	GREEN	1/250 sec.	
125X	GREEN	1/125 sec. (doubles as auto flash synch)	
60	GREEN	1/60 sec.	Indications for speeds 1/30 sec. thru 4 sec. given in Yellow as a warning against camera shake.
30	YELLOW	1/30 sec. shutter speed setting	
15	YELLOW	1/15 sec.	
8	YELLOW	1/8 sec.	
4	YELLOW	1/4 sec.	
2	YELLOW	1/2 sec.	
1	YELLOW	1 sec.	
2S	YELLOW	2 sec.	
4S	YELLOW	4 sec.	
UNDER	RED	Underexposure Warning.	
Focusing LEDs	▶	Direction to turn the lens to focus.	
		"in-focus" indication.	
	▶ ◀	Out of "electronic focus range; focus manually.	

## SPECIFICATIONS

<b>Type</b>	35mm full-frame, Auto/Manual exposure SLR camera.
<b>Body Mount</b>	Pentax KF-Mount (accepts K-Mount Lenses, and KF-mount AF lens).
<b>Standard Lenses</b>	SMC Pentax AF Zoom 35mm–70mm f/2.8, SMC Pentax-M 50mm f/1.2, M 50mm f/1.4, M 50mm f/1.7, M 50mm f/2, M 40mm f/2.8.
<b>Shutter</b>	Seiko MFC-E2 vertical-run metal focal plane shutter; automatic shutter speeds electronically controlled from 1/2000th to 4 seconds; electronic manual speeds from 1/2000th to 4 seconds at 14 viewfinder settings; plus "125X" and "B"; mechanical self-timer with 4 - 10 second delay.
<b>Flash Synch</b>	Automatic at 1/125 sec. via hotshoe (with Pentax AF-160, AF-200S, AF-280T, AF-080C); manual at 1/125X via hotshoe or terminal on camera body with other units.
<b>Exposure Control</b>	Open-aperture, center-weighted, through-the-lens light metering by GPD cells. Exposure range from EV-1 to EV-19 (ASA 100, f/1.4); ASA 12 - 1600. Auto exposure compensation up to + 2EV via dial; meter activated by light pressure on shutter button or focus button of AF lens. 10 - 12 sec. exposure display.
<b>Viewfinder</b>	Pentaprism finder with split-image microprism focusing screen; shows 92% of picture area, 0.87X magnification (50mm 1.4 lens) -1.0 diopter eyepiece. Green LEDs in finder indicate handholdable shutter speeds from 1/2000th second to 1/60th second, yellow LED camera "shake warning (1/30th to 4 sec.); red LED over/under exposure warning; Manual and Exposure compensation warnings; flash synch/ready indication, Auto/electro "in-focus", directional and "out-of-range" indicators.



<b>TTL EFC SYSTEM</b>	(Through-the-Lens Electronic Focus Control). Microcomputer circuitry inside camera and MOS image sensor measure subject contrast, provide focus guidance with regular SMC Pentax Lenses (24mm–300mm), full auto focus with Pentax AF Lens (AF ZOOM 35mm–70mm f/2.8). EV range from EV-4 to EV-16 (with 50mm lens at f/1.4); electro focus switch varies image sensor sensitivity.
<b>Power Source</b>	Four 1.5-volt silver-oxide batteries, (S-76 or equivalent) power all focus indication and exposure systems (alkaline batteries not recommended).
<b>Film Transport</b>	Pentax Magic Needle Loading System; single-stroke rapid wind lever with 130° throw and 35° standoff angle; crank film rewind; built-in shutter-cocked indicator; accepts Winder ME-II, ME for auto film advance.
<b>Other Features</b>	Interchangeable camera back accepts data printer (Dial Data ME), Tripod socket, strap hooks; accepts wide range of Pentax system accessories.
<b>Size</b>	32mm x 87.5mm x 49mm.
<b>Weight</b>	480g (without batteries); 675g with f/1.7 lens.

## SMC PENTAX AF ZOOM 35mm–70mm f/2.8

<b>Construction</b>	7 elements in 7 groups.
<b>Mount</b>	Pentax KF-Mount (for K-Mount, KF-Mount cameras).
<b>Angle of View</b>	63.5° at 35mm; 34.5° at 70mm.
<b>Focusing</b>	Complete TTL auto focus with Pentax ME-F; manual focus with K-mount Pentaxes.
<b>Diaphragm</b>	Fully automatic with open-aperture metering.
<b>Aperture Range</b>	f/2.8 - f/22
<b>Minimum Focus</b>	1.2 meters.
<b>Zooming System</b>	Push/Pull zoom collar.
<b>Lens Coating</b>	Pentax Super-Multi-Coating.
<b>Power Source</b>	Four 1.5-volt AAA-size batteries power micromotor.
<b>Switches/Controls</b>	Focus motor power switch, focus button (two) on lens.
<b>Filter Size</b>	58mm (screw-in type)
<b>Lens Hood</b>	Slip-on rubber hood.
<b>Size</b>	87mm(H) x 73mm(dia) x 76.5mm (Length).
<b>Weight</b>	580 g (without batteries).

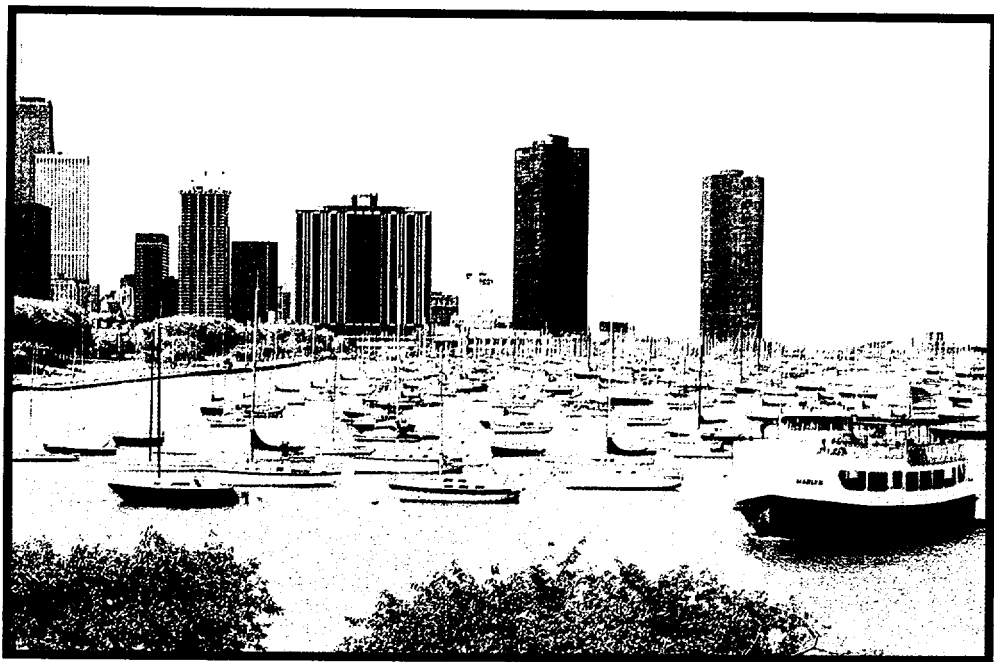

## WARRANTY POLICY

All Pentax cameras purchased through authorized bona fide photographic distribution channels are guaranteed against defects of material or workmanship for a period of twelve months from date of purchase. Service will be rendered and defective parts will be replaced without cost to you within that period, provided the equipment has not been abused, altered, or operated contrary to instruction. Because the tolerances, quality, and design compatibility of lenses other than Pentax lenses are beyond our control, damage caused by use of such lenses will not be covered by this warranty policy. The manufacturer or its authorized representatives shall not be liable for any repair or alterations except those made with its written consent and shall not be liable for damages from delay or loss of use or from other indirect or consequential damages of any kind, whether caused by defective material or workmanship or otherwise; and it is expressly agreed that the liability of the manufacturer or its representatives under all guarantees or warranties, whether expressed or implied, is strictly limited to the replacement of parts as hereinbefore provided.

### **Procedure During 12-month Warranty Period**

Any Pentax which proves defective during the 12-month warranty period should be returned to the dealer from whom you purchased the equipment or to the manufacturer. If there is no representative of the manufacturer in your country, send the equipment to the manufacturer, with postage prepaid. In this case, it will take a considerable length of time before the equipment can be returned to you owing to the complicated customs procedures required in Japan in importing and re-exporting photographic equipment. If the equipment is covered by warranty, repairs will be made and parts replaced free of charge, and the equipment will be returned to you upon completion of servicing. If the equipment is not covered by warranty, regular charges of the manufacturer or of its representatives will apply. Shipping charges are to be borne by the owner. If your Pentax was purchased outside of the country where you wish to have serviced during the warranty period, regular handling and servicing fees may be charged by the manufacturer's representatives in that country. Notwithstanding this, your Pentax returned to the manufacturer will be serviced

free of charge according to this procedure and warranty policy. In any case, however, shipping charges and customs clearance fees are to be borne by the sender. To prove the date of your purchase when required, please keep the receipts or bills covering the purchase of your equipment for at least a year. Before sending your equipment for servicing, please make sure that you are sending it to the manufacturer's authorized representatives or their accredited repair shops, unless you are sending it directly to the manufacturer. Always obtain a quotation of the service charge, and only after you accept the quoted service charge, instruct the service station to proceed with the servicing.

**This warranty policy does not apply to Pentax products purchased in the U.S.A., U.K., or Canada. The local warranty policies available from Pentax distributors in those countries supersede this warranty policy.**

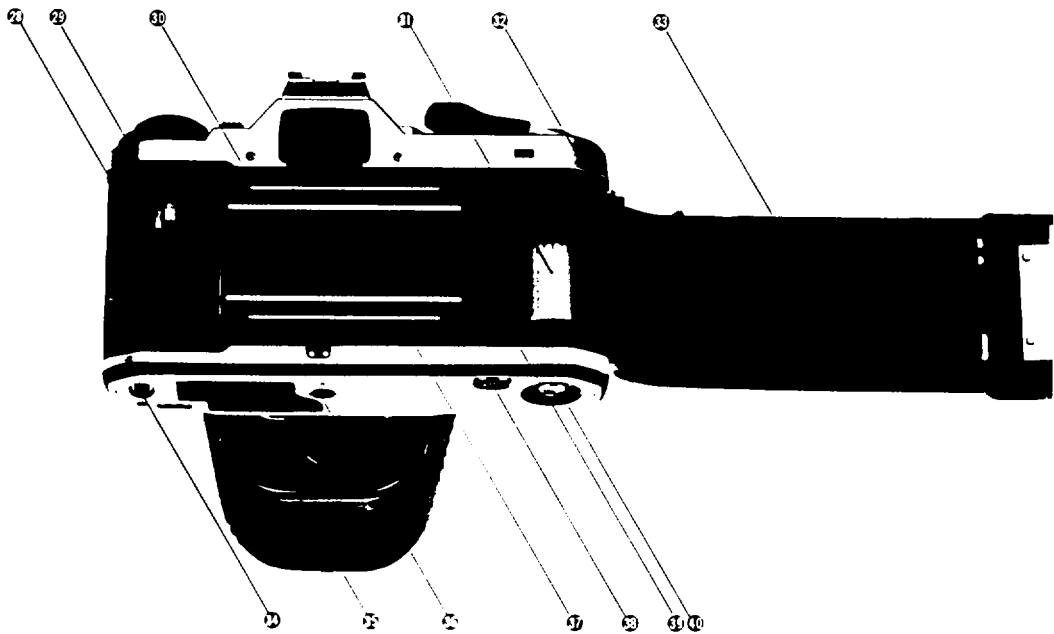

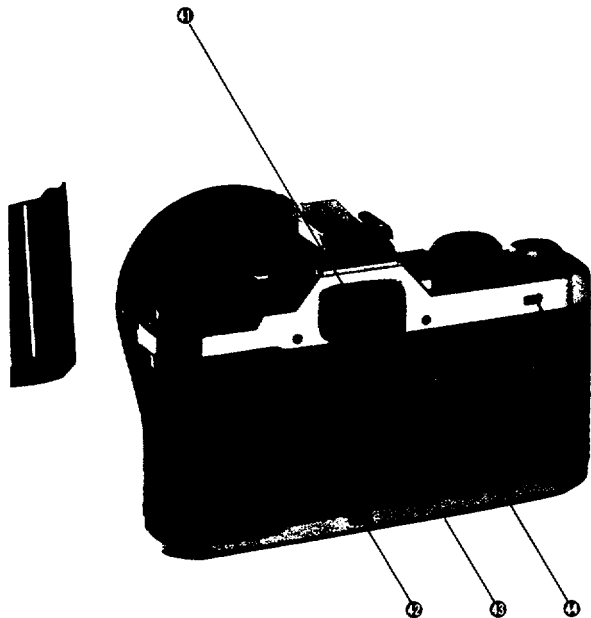

- 28 Film chamber
- 29 Film advance claw
- 30 Film guide rail
- 31 Film take-up spool
- 32 Back cover release lug
- 33 Film pressure plate
- 34 Battery compartment lock release
- 35 Battery compartment
- 36 Winder/tripod receptacle
- 37 Shutter
- 38 Film rewind button
- 39 Sprocket
- 40 Film transport coupler
- 41 Viewfinder eyepiece
- 42 Cordless Dial Data Contact
- 43 Memo holder
- 44 Back cover
- 45 Film advance/rewind indicator



**Asahi Optical Co., Ltd.** C.P.O. 895, Tokyo 100-91, JAPAN  
**Asahi Optical Europe N.V.** Weiveidlaan 3-5, 1930 Zaventem Zuid-7, BELGIUM  
**Pentax Handelsgesellschaft mbH.** 2000 Hamburg 54 (Lokstedt), Postfach 54 01 69, WEST GERMANY  
**Pentax U.K. Limited** Pentax House, South Hill Avenue, South Harrow, Middlesex HA2 0LT, U.K.  
**Pentax France S.A.,** 72-76 rue Paul Vaillant Couturier, 92300 Levallois-Perret, FRANCE  
**Pentax (Schweiz) AG** Industriestrasse 2, 8305 Dietlikon ZH, SWITZERLAND  
**Pentax Svenska AB** Hornsgatan 50A, 11721 Stockholm, SWEDEN  
**Pentax Nederland** Spinveld 25, 4815 HR Breda, THE NETHERLANDS  
**Pentax Corporation** 35 Inverness Drive East, Englewood, Colorado 80112, U.S.A.  
**Pentax Canada Inc.** 1760 West 3rd Avenue, Vancouver, B.C. V6J 1K5, CANADA  
**Asahi Optical Brasileira Ind. e Com. Ltda.** Rua Estados Unidos, 1053, São Paulo SP, BRASIL

Specifications are subject to change without notice.

06211ENG