

# PENTAX

## M/G

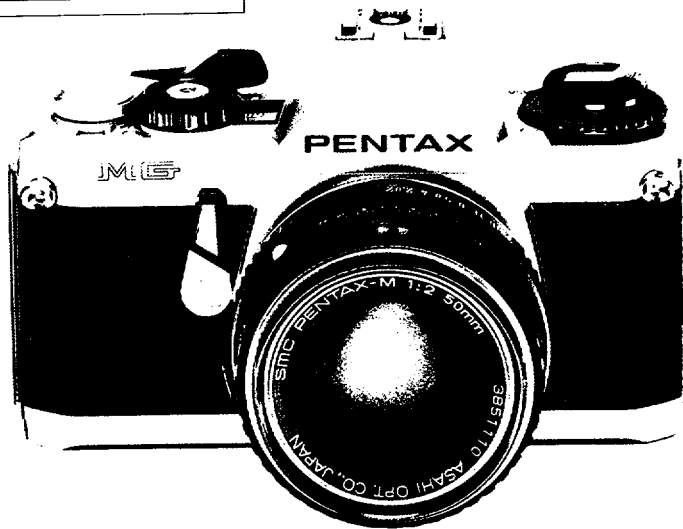

## CONTENTS

Description of parts .....	2
Basic operating instructions "Your MG Quick Course" .....	4
Inserting batteries .....	8
Lens mounting .....	10
Film loading and winding .....	11
Setting the ASA film speed .....	13
The shutter mode dial .....	14
Aperture setting .....	17
Focusing .....	18
Exposures on "Auto" .....	19
Auto exposure compensation .....	22
Self-timer/Multiple exposures .....	24
Using a tripod/Time exposures at "B" .....	25
Holding the camera .....	26
Unloading the film .....	27
Flash photography (with Pentax Dedicated Flash Units) .....	28
Other flash units .....	29
Shooting pointers .....	30
Depth-of-field scale .....	32
Depth-of-field table .....	33
Using screw mount Takumar lenses .....	34
Infrared photography .....	36
Open aperture and stop-down metering .....	37
Resistance to temperature extremes and variations .....	38
Camera maintenance .....	40
Meter coupling range .....	42
Viewfinder diagram .....	44
Specifications .....	46
Warranty policy .....	48

---

## Welcome to Pentax Photography!

Your MG is one of the fine 35mm SLR cameras constituting the Pentax family of SLR cameras. By following these simple instructions, you'll find that your camera will not only give you results you never believed possible with everyday photography, but it also offers a host of innovative features, from convenient "dedicated" automatic flash with the Pentax electronic flash units, to sequence action photographs with two Pentax automatic film winders, to a wide range of accessories for applications in close-up, macrophotography and even 3D photography when used with a special stereo adaptor.

To help you take pictures right away, we've provided an "MG Quick Course" on pages 4 ~ 6 which gives you a general outline of how to use the camera. For additional information refer to the pertinent sections of the manual for operating details. Also, be sure to read the entire manual the first chance you get to learn of all the benefits your camera has to offer and ensure years of trouble-free operation.

## DESCRIPTION OF PARTS

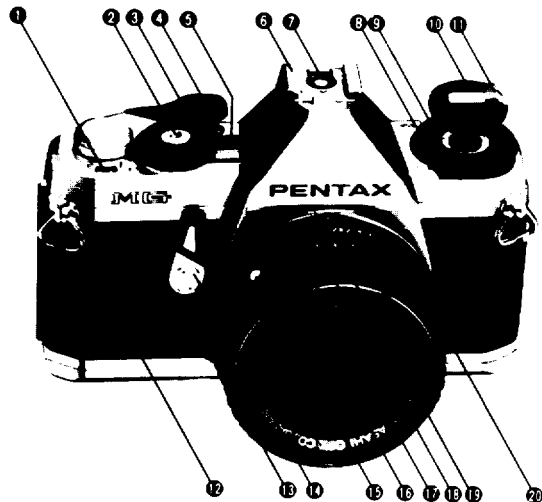

- ① Exposure counter
- ② Shutter button
- ③ Rapid wind lever
- ④ Shutter cocked indicator
- ⑤ Shutter mode indications
- ⑥ Hotshoe
- ⑦ Auto flash contact
- ⑧ ASA film speed index
- ⑨ Exposure compensation guide
- ⑩ Film rewind/Back cover release
- ⑪ Film rewind crank
- ⑫ Neck strap eyelet
- ⑬ Lens release lever
- ⑭ Self-timer lever
- ⑮ Lens alignment node
- ⑯ Focusing ring
- ⑰ Distance scale
- ⑱ Depth-of-field scale
- ⑲ Aperture/Distance index
- ⑳ Aperture ring

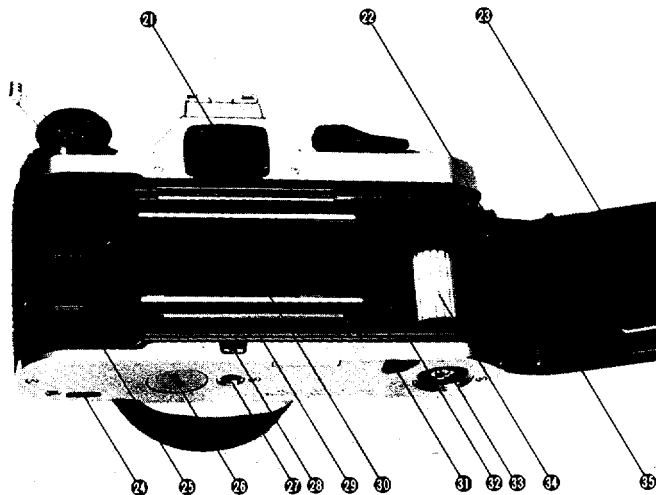

- ① Viewfinder eyepiece
- ② Back cover release lug
- ③ Film pressure plate
- ④ Winder contact terminal
- ⑤ Film chamber

- ⑥ Battery compartment
- ⑦ Winder/tripod receptacle
- ⑧ Cordless dial data contact
- ⑨ Film guide rail
- ⑩ Shutter
- ⑪ Film rewind button
- ⑫ Sprocket
- ⑬ Film transport coupler
- ⑭ Film take-up spool
- ⑮ Back cover

## BASIC OPERATING INSTRUCTIONS

"Your MG Quick Course"

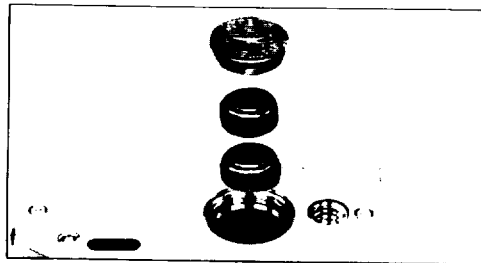

1. Insert the batteries as shown. (Page 8);  
Mount the lens (Page 10).

2. Load the film with the shutter mode dial set at "100X," and advance to the first exposure. (Page 11).

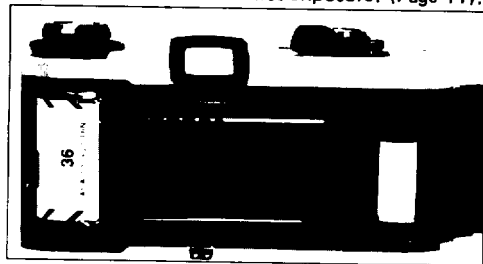
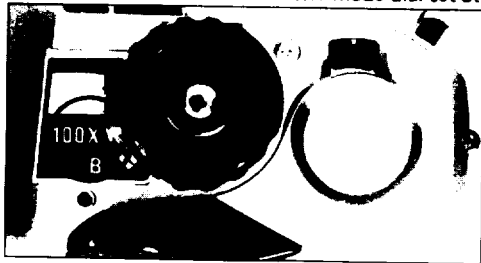

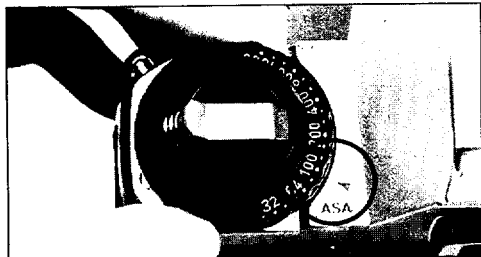

3. Set the ASA film speed (Page 13).

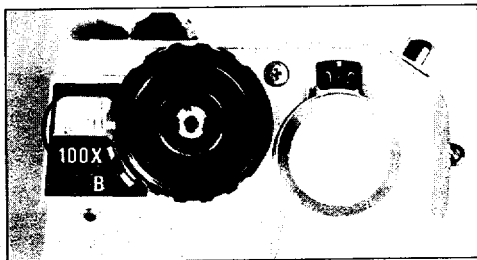

4. Set the shutter mode dial to "AUTO" (Page 14).

5. Set the lens aperture. (Page 17).

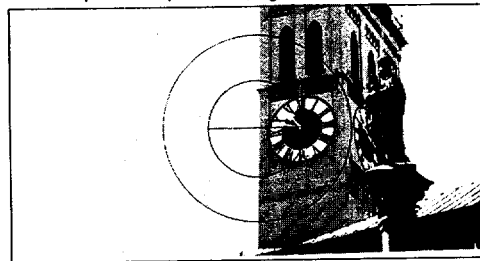
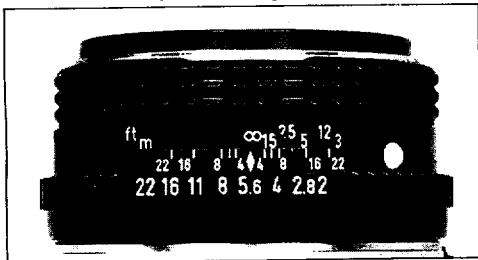

6. Look through the viewfinder, focus and compose the picture (Page 18).

7. Activate the meter by pressing the shutter button partway.

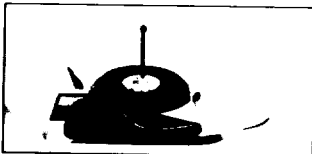

If the green LED lights (between "1000" and "60"): take photo.



If red OVER or UNDER light:

•	OVER	}	Change the f/stop until green appears.
•	1000		
•	500		
•	250		
•	125		
•	60*X		
•	30		
•	15		
•	8		
•	4		
•	2	}	
•	1		
•	UNDER		

If YELLOW LEDs light (between "30" and "1"):

•	OVER	}	<ul style="list-style-type: none"> <li>(1) use a wider aperture (Page 21).</li> <li>(2) use a tripod, etc. (Page 25).</li> <li>(3) use a flash unit (Page 28).</li> </ul>
•	1000		
•	500		
•	250		
•	125		
•	60*X		
•	30		
•	15		
•	8		
•	4		
•	2	}	
•	1		
•	UNDER		





## INSERTING BATTERIES

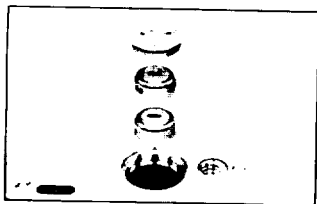

The electronic systems of your Pentax MG operate on two 1.5-volt mini batteries (S76, etc.) which are packed separately with your camera.

**To insert the batteries:** Turn the battery compartment cover counter-clockwise with a coin and remove the cover. Place the batteries in the chamber with polarity markings as shown. Replace the cover, by turning it clockwise until it screws firmly in place.

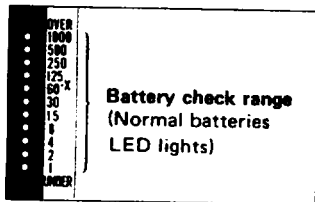

**Battery Check:** After inserting the batteries, make a quick check to see that the batteries are inserted properly and that the camera's electrical systems are functioning. *To check batteries:* Press the shutter button partway and observe the viewfinder LED shutter speed display. One of the shutter speed LEDs between "1000" and "1" will glow continuously if the voltage supply for the camera's exposure system is adequate.

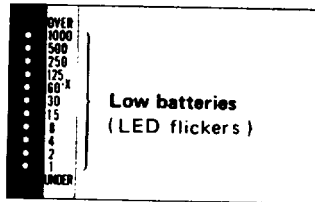

**Low Battery Warning:** When batteries become too weak for the exposure system to operate, the viewfinder shutter LEDs will begin to flicker.\* Although the camera will continue to make accurate exposures until the display goes out completely, *both* batteries should be replaced promptly at this point to ensure uninterrupted operation.

**Mechanical Shutter Speeds:** If the batteries fail and you don't have replacements, you can make manual exposures without the meter at the "100X" (1/100 sec.) and "B" mechanical shutter speeds.

**Battery Care:**

- Battery life will vary from several months to a short period depending on the frequency of the camera's use. Batteries will last about 1 year in an ideal camera. When batteries require replacement, replace them both with the equivalent 1.5 volt silver-oxide batteries (Eveready S76, MALLORY S76E, etc.) or alkaline batteries. Do not mix battery brands or types and do not mix old batteries with new batteries. (This is dangerous and can actually shorten the battery life).
- Wipe the battery with a dry cloth before insertion and always handle by the edges to ensure proper contact.
- Keep spare batteries on hand to avoid the inconvenience of battery failure during a busy picture-taking session. When shooting in a cold climate temporarily battery failure due to freezing temperatures is common, so keep replacements in a warm pocket.
- When not using the camera for long periods of time, remove the batteries to avoid battery leakage.

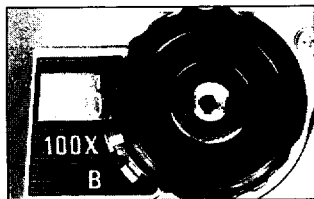

**IMPORTANT!**

Never throw used batteries into a fire or expose them to excessive heat as a precaution against explosion. Always keep batteries out of the reach of children.

## LENS MOUNTING

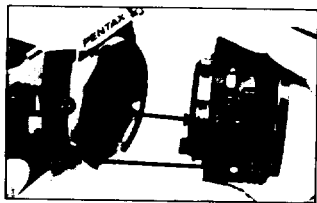

- Remove the rear lens and body mount covers. Hold the camera securely in your left hand and match the red dot **A** on the camera body with the red dot **B** on the lens.

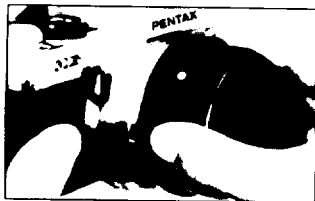

- Seat the lens in the body mount and turn it clockwise until it locks into place with a "click." If it's dark and the red dots are difficult to see, align the raised white node **C** on the lens barrel with the lens release lever **D** by touch and mount the lens as described.

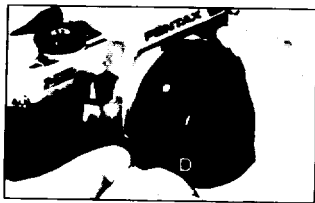

**Removing the lens:** To remove the lens, hold the camera in the left hand and press the lens release button **D** while turning the lens counter-clockwise with the right hand.

**IMPORTANT:** If it's necessary to put the lens down without the rear lens cap, make sure you rest the lens with the front element down. Never put the lens down with the front element up because you can damage the rear elements. Long telephoto lenses should be laid on their side to avoid tumbling.

## FILM LOADING AND WINDING

To avoid unnecessary delays when loading the film, set the shutter mode dial to "100X." If you must load the film with the dial set to "AUTO," remove the lens cap and aim the camera toward a bright light source. This avoids excessively long shutter speeds while advancing the film.

- To open the camera back, lift the film rewind knob up sharply. Insert the film cartridge in the film chamber and lock the cartridge in place by returning the film rewind knob to its original position.

- Draw the film leader across the back and insert it into any of the white needles in the film take-up spool. Make sure the film is engaged properly on the spool by inserting the leader at least the width of one perforation.

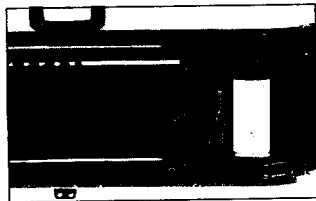
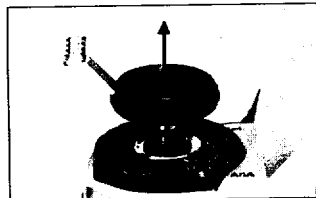
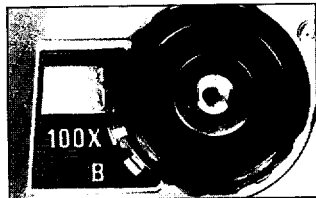

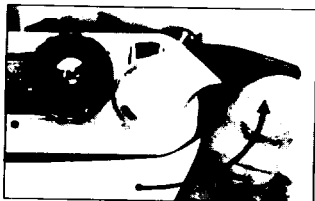

- Wind the film by alternately advancing the rapid wind lever and firing the shutter release button until both top and bottom sprockets engage the film perforations.

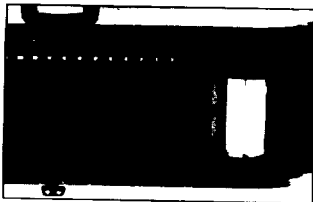

- When you are sure the film is engaged properly, close the back cover and wind the film rewind crank in the direction of the arrow to take up any slack.

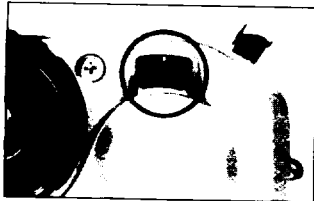

- Continue advancing the film until the exposure counter registers "1." You can be sure the film is moving properly through the camera by checking to see that the film rewind crank rotates as you wind the film. When the film is advanced properly and the camera is ready to take the picture, the shutter cocked indicator will turn red; this also serves as a warning against accidental shutter release.

Reset the shutter dial to "Auto."

## SETTING THE ASA FILM SPEED

The ASA film speed rating of all 35mm films is given in the data sheet packed with each roll of film. The higher the ASA number, the more sensitive the film is to light. To set the index, lift up the ASA dial **A** and turn it until the ASA number of your film is opposite the orange index mark.

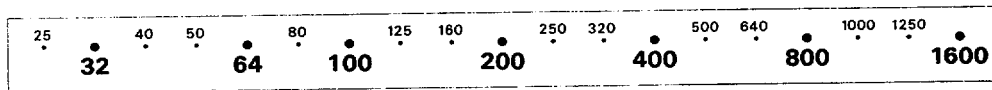
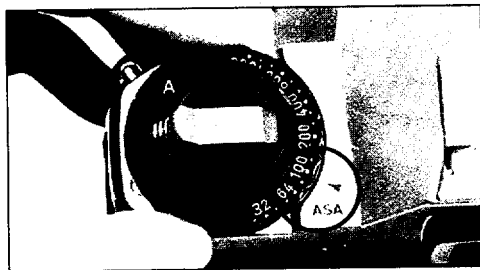

## THE SHUTTER MODE DIAL

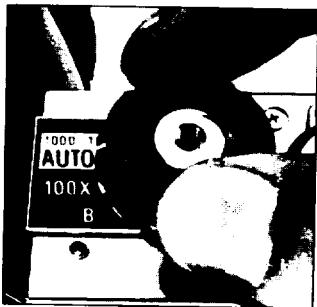

Because the camera selects the shutter speed automatically with the shutter set to "AUTO," your MG does not feature a conventional shutter speed dial. In its place is a shutter mode dial which you simply set to "AUTO" for normal shooting, or one of the other two settings for special shooting situations such as flash or time exposures.

**To set the dial:** Rotate the dial until the index aligns with the desired setting.

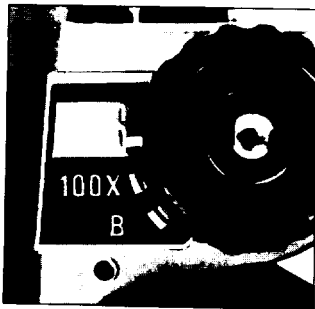

**"AUTO":** This setting is used for normal shooting except flash and time exposures. Keep the dial set to "AUTO" so that you will always be ready to shoot when the opportunity presents itself. For daylight shooting you can preset the lens aperture at  $f/5.6$  or  $f/8$  and obtain accurately exposed pictures by simply focusing the lens and pressing the shutter button (See EXPOSURES ON AUTO—Page 19).



**"100X"**: This setting is provided mainly for mechanical flash synchronization at 1/100th second for flash units which do not offer automatic flash synchronization (see Page 31).

Since the shutter operates without batteries at this setting, it also permits you to continue operating the camera in case of battery failure. If the batteries fail, set the dial to "100X" and adjust the lens aperture according to the subject brightness (refer to the exposure guide lines accompanying your film.)

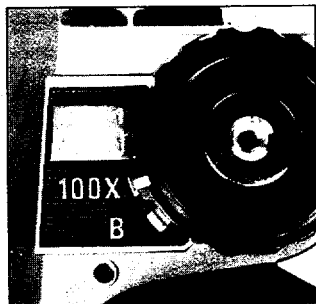

**"B" (Bulb)**: This setting is for long exposures exceeding the 1-second maximum shutter speed of the camera's electronic exposure system. Time exposures lasting several minutes or hours can be made at this setting (see "TIME EXPOSURES AT "B," Page 25).

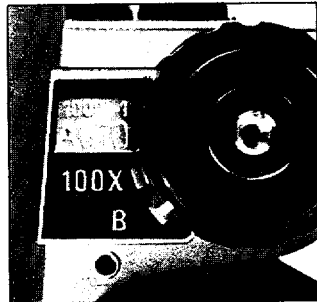



## APERTURE SETTING

Keep the exposure mode dial set at AUTO. Rotate the lens' aperture ring and select the lens aperture (f-stop) according to the following conditions.

Fine weather .....	f/8 – f/11
Cloudy weather .....	f/4 – f/5.6
Indoors .....	f/1.4 – f/2.8

The above is a rough guide which is useful for most shooting situations. These apertures will give you accurate exposures when the green viewfinder LED is lit. If the LED is another color, reset the aperture according to the instructions on the following pages. Although these instructions are all you need to obtain quality pictures, as you gain more experience, you will want to experiment with different exposures for special effects. You can learn about these techniques by referring to the section entitled, "Shooting Pointers," (Page 30).

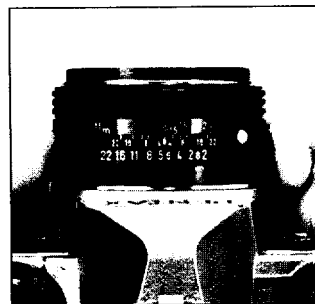
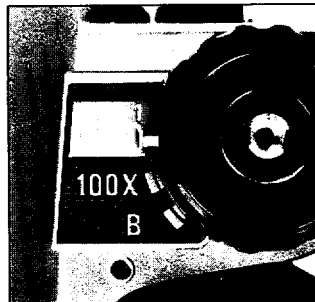

## FOCUSING



The MG comes equipped with a split-image/microprism focusing screen which provides a split-image center spot surrounded by a microprism collar on a matte field. You can focus using all three areas of the focusing screen.

**To focus with the split-image center spot:** Simply turn the lens focusing ring until the broken image in the center spot of the viewfinder aligns as one.

**To focus with the microprism collar:** When using the microprism collar surrounding the center spot, rotate the lens focusing ring until the "shimmering" effect in the collar area disappears.

**The matte field:** This is quite convenient for focusing with small aperture long telephoto lenses. To focus, turn the focusing ring on the lens until the image appears sharp and crisp on the matte field.

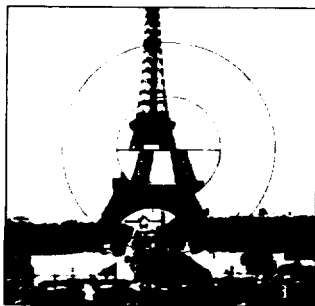

## EXPOSURES ON AUTO

The normal operating mode of your camera is the "Auto" exposure mode. With the shutter dial set to "Auto," the camera selects the correct shutter speed automatically in correlation to the preset lens aperture. Sharply focused, accurately exposed pictures are easily obtained by simply presetting the camera as outlined below. Additional adjustments may be required in extreme lighting situations. Generally, changing the lens aperture is sufficient but exposures can sometimes be improved by using a tripod, electronic flash, or the exposure compensation.

**For exposure setting perform the following:**

- (1) Make sure the film speed is set properly (Page 13).
- (2) Set the shutter mode dial to "AUTO."
- (3) Preset the lens aperture according to general lighting conditions.

**Exposure Check:** Look through the viewfinder and lightly press the shutter button; the LED (light-emitting-diode) shutter speed display inside the viewfinder will light to indicate the shutter speed (The display shuts off automatically 25 ~ 40 seconds after you release your finger from the shutter button).

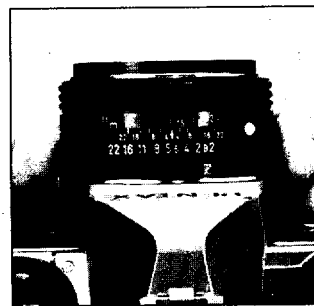
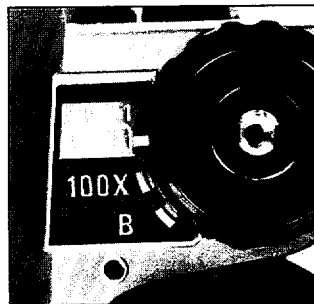

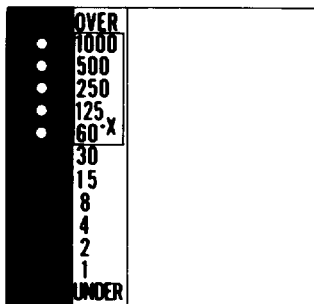

The figures in the viewfinder from "2" to "1000" refer to shutter speeds in fractions of seconds (i.e., 1/2 sec. to 1/1000 sec.); "1" indicates one second.

**GREEN LED – Correct Exposure – "Go ahead and shoot"**

Green LEDs are used along the shutter speed scale between 1/1000th second and 1/60th second to indicate that the shutter speed is fast enough to hand hold the camera.

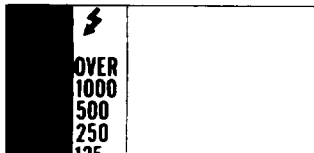

**RED "OVER" LED – Overexposure**

A red LED will glow next to the "OVER" indicator in the viewfinder to indicate overexposure. When this occurs, stop the lens down to a smaller aperture until one of the green LED lights.

**CAUTION:** If you should happen to press the shutter button while the shutter dial is set on AUTO with the lens cap on or in very poor lighting conditions, the mirror may lock up, resulting in an excessively long exposure. To re-set the camera, move the dial to the "100X" setting and return it to the "AUTO" position before shooting.

### **YELLOW LED – Slow Exposure/Camera Shake Warning**

Yellow LEDs are used along the shutter speed scale between 1/30 second and 1 second as a slow shutter speed warning, and as a reminder to use a tripod, change the lens to a wider aperture setting, or use flash (see Page 28).

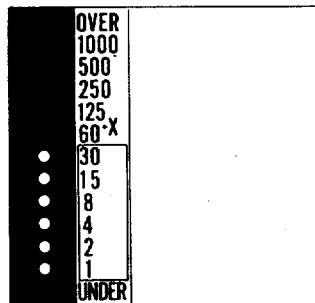

### **RED "UNDER" LED – Underexposure**

A red LED will glow next to the "UNDER" indicator on the viewfinder scale when there is insufficient light for proper exposure. If this occurs, and a faster shutter speed is not available, switch to time exposures (see Page 25), or flash (see Page 28).

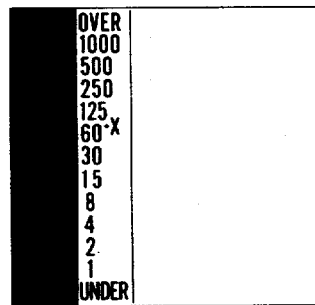

## EXPOSURE COMPENSATION

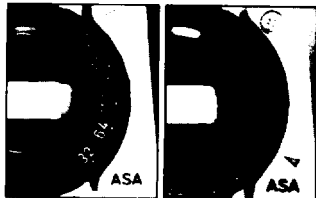
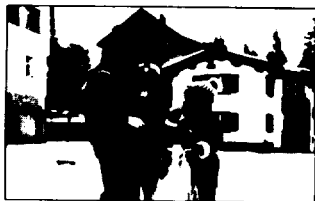

When shooting in difficult lighting situations such as when the subject is situated against the light (direct sun, snow, a bright window) or when spotlighted on stage, etc., either additional or less exposure is required to override the influence of the strong backlighting and bring out the details of the subject. Such problems are easily corrected by temporarily altering the setting of the ASA film speed dial for the shot requiring exposure compensation.

**Backlit Subjects:** For subjects with the sun behind them, standing against the light, bright snow, etc, compensate by lowering the ASA film speed value to half or four times the ASA film speed. For example:

**With ASA 100 film in the camera:** reset the dial to ASA 50 or ASA 25 (this gives 2X and 4X compensation, respectively).

**With ASA 400 film:** reset the ASA dial to ASA 200 (2X) or ASA 100 (4X).

**Spotlighted Subjects:** For subjects on a spotlighted stage, etc., decrease your exposure by doubling or quadrupling the ASA film speed value. For example:

**With ASA 100 film:** reset the dial to ASA 200 (1/2X) or ASA 400 (1/4X).

**With ASA 400 film:** reset the dial to ASA 800 (1/2X) or ASA 1600 (1/4X)

Always reset the ASA dial to its original setting after employing exposure compensation.



**Exposure-Compensation-Indicator Dial:** You may also use the exposure-compensation-indicator dial located under the film rewind crank as a guide for exposure compensation. **To Use:** Fold out the film rewind crank as if to rewind the film and lift the knob **slightly** to expose the exposure-compensation-indicator dial. (CAUTION: BE VERY CAREFUL NOT TO PULL HARD AS THE BACK COVER WILL SPRING OPEN, EXPOSING YOUR FILM.) Next, turn the top of the dial with your finger until the index mark of the exposure compensation dial aligns with the ASA index mark and the ASA number of the film loaded in the camera (Illust. A). When properly aligned, lift the ASA dial and reset it as follows for exposure compensation.

**For 2X compensation:** To the first dot on the indicator's plus side (Illust. B).

**For 4X compensation:** Second dot on the plus side.

**For 1/2X compensation:** First dot on the minus side.

**For 1/4X compensation:** Second dot on the minus side.

After setting the compensation, push the film rewind crank shaft back in place and take the picture. BE SURE TO RESET THE ASA FILM SPEED DIAL TO AGREE WITH THE FILM LOADED IN THE CAMERA WHEN COMPENSATION IS NO LONGER REQUIRED.

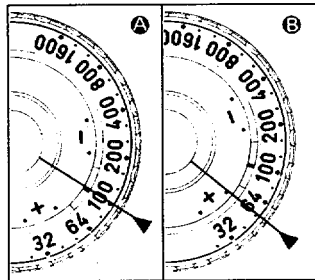

## SELF-TIMER/MULTIPLE EXPOSURES

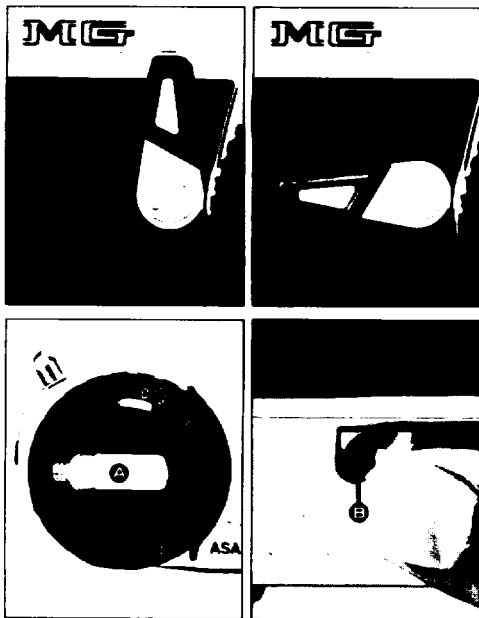

### Self-Timer

The self-timer delays release of the shutter 4 – 10 sec., depending upon how far the self-timer lever is advanced. To operate the self-timer, push the lever counterclockwise until it stops. To start, push up slightly on the self-timer lever. Note: Cover the viewfinder eyepiece with the accessory Finder Cap when using the self-timer; otherwise, light entering from the rear of the camera may adversely affect the exposure.

### Multiple Exposures

For deliberate multiple exposures, make the first exposure in the normal way. Then tighten the film by turning the rewind knob **A**, and keep hold of the rewind knob. Depress the film rewind button **B** and advance the rapid-wind lever. This cocks the shutter without advancing the film. Finally, release the shutter to make the second exposure. Then make one blank exposure, before taking the next picture, to avoid overlapping. As the exposure counter continues to function each time the shutter is cocked, a double exposure will be counted as two frames.

## USING A TRIPOD/TIME EXPOSURES AT "B"

### Using a Tripod

The camera may be mounted directly to a tripod by screwing the tripod into the socket at the base of the camera. Be sure the tripod screw protrudes no more than 5.5mm (0.22in.) from the tripod. This is the depth of your camera's tripod socket. Don't use a longer screws as it may puncture the bottom of the tripod socket if tightened too firmly.

**Tripod Spacer:** In order to prevent large diameter lenses from interfering with proper mounting of the camera to the tripod, insert the Spacer Ring (packed with the camera) between camera and tripod.

**Finder Cap:** When you make exposures with your eye away from the viewfinder while using a tripod (or at any other time), cover the viewfinder eyepiece with the accessory Finder Cap; otherwise, light entering from the rear may adversely affect the exposure.

### Time Exposures at "B"

Exposures longer than 1 sec., exceed the range of the camera's electronic shutter and must be made at the "B" setting of the shutter mode dial. Here the shutter remains opened as long as the shutter release button is held depressed. To prevent movement of the camera during exposure, mount it on a tripod and attach a cable release to the hole in the shutter button to release the shutter. For exposures lasting several minutes or hours, use a cable release with a locking device.

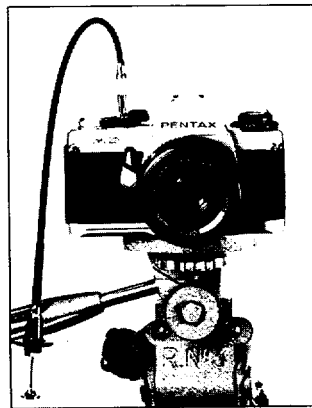
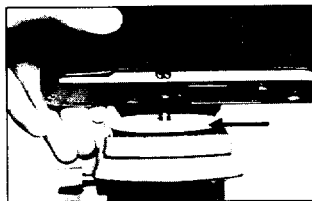

## HOLDING THE CAMERA

As a general rule, your camera can be held more firmly in the left hand, which does not release the shutter. If you hold your camera with the right hand — the hand that releases the shutter — this may cause camera movement. Often, blurred pictures are due to camera movement.

### Horizontal position A.

Hold the camera firmly with your left hand, and draw your arms close to your body.



### Vertical position B.

Hold your camera tightly to your forehead with your left hand, and draw your right arm close to your body.



### Vertical position C.

Hold your camera tightly to your forehead with your left hand, raise your right arm and draw your left arm to your body.



## UNLOADING FILM

After the last picture on the roll has been taken, the rapid-wind lever will not advance any further, indicating that the film must be rewound. (Caution: do not try to force the lever any further.) Fold out the rewind crank. Depress the film rewind button **A** and turn the rewind crank as indicated to rewind the film into its cartridge. Rewind until the tension on the crank lessens, indicating that the leader end of the film has been released from the take-up spool. Pull out the film rewind knob (the back will open automatically), and remove the film cartridge.

AVOID DIRECT LIGHT WHEN UNLOADING THE FILM.

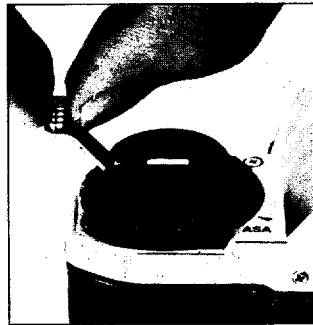
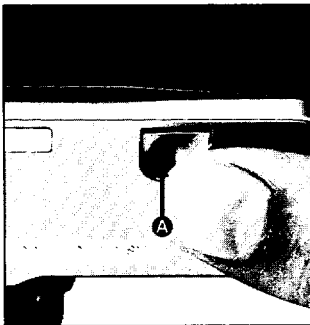

## FLASH PHOTOGRAPHY (With Pentax Dedicated Flash Units)

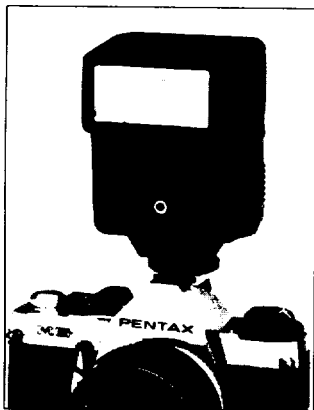

When used with any one of the Pentax "Dedicated" Automatic Flash Units,\* your MG offers the convenience of "dedicated" flash—automatic synchronization for flash on charging and flash ready indication inside the viewfinder.

**For Dedicated Auto Flash:** Set the shutter mode dial to "Auto" and attach the flash to the camera hotshoe. Set the flash mode according to the unit instructions and switch the flash on. When the unit charges, the camera will synchronize automatically for flash at 1/100th second. When the flash unit is ready, the LED symbol and X indicator inside the viewfinder will light signaling that the flash unit is ready. After taking the picture, the camera will return to the non-flash exposure mode until the unit has recycled. To cancel the flash exposure, simply switch the flash unit off.

\* Presently four of these flash units are available—AF-200S, AF-160, AF-280T, and AF-080C Ring Light.

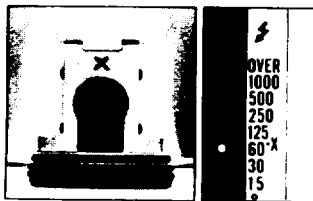

## OTHER FLASH UNITS

The MG can be used with a variety of hotshoe type flash units equipped for direct synchronization. It also works with units requiring a cord hook such as the AF-400T when the hotshoe adaptor unit is used. Bracket-mount type units can be mounted to the socket at the base of a tripod, and synchronized via the hotshoe adaptor.

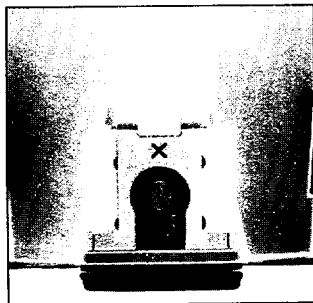

**For Flash Operation:** Synchronize the unit manually for flash by setting the shutter mode dial to "100X." Then, set the flash exposure as indicated in the instruction manual accompanying your flash unit.

**NOTE:** Viewfinder flash synchronization and flash ready indication are not given when the manual "100X" setting is used. ("Dedicated" flash operation is not offered for the AF-400T when used with the MG).

**IMPORTANT:** Use of dedicated flash units other than Pentax may damage the camera's electronic circuitry and precautions should be taken. Also, when using the Pentax Superlite II, synchronize for flash at the mechanical "100X" shutter speed setting only.

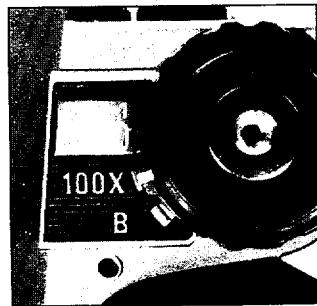

## SHOOTING POINTERS

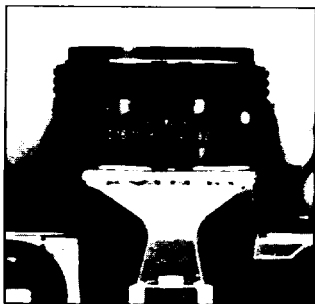

The tri-colored viewfinder indications of your MG's automatic exposure system make it extremely easy to obtain good results in a wide variety of shooting situations. However, there are a few basic aperture and shutter speed control techniques which help guarantee best results with moving subjects, special effects, and so forth. If SLR photography is relatively new to you, it will be worthwhile to learn these few basic techniques.

### Optimum Apertures

The aperture guide listed on page 17 is sufficient for almost all shooting purposes and correct exposure will be obtained as long as one of the green shutter speed LEDs light. However, you may add more interest to your pictures with certain subjects by varying from the norm. Any aperture setting may be used as long as either a green or yellow LED shutter speed indicator lights (in the case of the latter, provided you take precautions against camera shake).

**Stopping the Action:** With moving subjects such as bicycles, automobiles, horses, children at play, birds in flight, etc., a fast shutter speed is necessary to stop the action and prevent the subject from blurring. With manual exposures, this problem is solved by preselecting a fast shutter speed such as 1/250 sec., 1/500 sec., 1/1000 sec., etc. However, when shooting on "AUTO," you can usually select a shutter speed fast enough to stop the action simply by using a wide lens aperture. As the camera automatically chooses the fastest possible shutter speed for the given exposure, wide



apertures will give you shutter speeds in excess of 1/250 sec. when lighting is sufficient. (NOTE: This technique does not work in low-lighting as low lighting necessitates a slow shutter speed.)

**Depth-of-Field Control:** Depending upon the aperture in use, the overall sharpness of the picture area in front and behind the subject will vary greatly. This effect is known as "depth of field" and can be used to vary the overall effect of your photos.

**Maximum Depth of Field:** The depth of field becomes progressively deeper as the lens is stopped down to smaller lens apertures and is greatest at minimum aperture. Thus, if you desire to have both your subject and the background in focus, use a small aperture such as f/11 or f/16 (be sure to take precautions against camera shake if a yellow LED (lights). Small apertures are also useful for critical close-up work, but for this, refer to a close-up photography guide.

**Out-of-Focus Highlights:** The depth of field becomes progressively shallower at wide lens apertures, and is shallowest at f/2, f/1.7 or f/1.4, depending upon which is the maximum aperture of your lens. A shallow depth of field produces an out-of-focus effect which highlights your subject. As long as the LED does not light at the "OVER" setting, you can obtain this effect, even on a bright, sunny day, by using a wide maximum aperture.



## DEPTH-OF-FIELD SCALE

Depth of field is the range between the nearest and farthest distances which are in focus at a given lens aperture.

If you want to know how great the depth of field is at a certain aperture, focus on the subject and look at the depth-of-field scale on the lens. In the photograph below the distance scale is set at 5 meters; that is, the lens is focused on a subject 5 meters away. The calibrations on each side of the distance index correspond to the diaphragm setting and indicate the range of in-focus distance for different lens aperture.

For example, if a lens opening of  $f/4$  is to be used, the range on the distance scale indicated within the figure 4 on the depth-of-field scale indicates the area in focus at that lens opening. You will note from the depth-of-field scale in the photograph that the range from approximately 4 to 7m is in focus. Note that as the lens apertures change, the effective depth of field also changes. For the depth of field at different apertures and distances, refer to the next page.

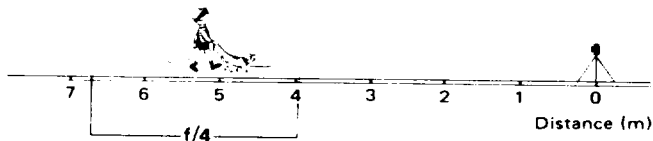
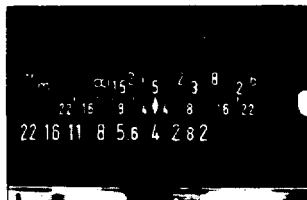

# DEPTH-OF-FIELD TABLE: SMC PENTAX-M 50mm LENS

unit=meter

Distance scale	0.45m	0.6m	1m	1.6m	2m	3m	5m	15m	∞
f/1.4	0.447 ~ 0.453	0.595 ~ 0.605	0.984 ~ 1.017	1.557 ~ 1.645	1.932 ~ 2.073	2.846 ~ 3.172	4.579 ~ 5.506	11.712 ~ 20.868	52.938 ~ ∞
f/2	0.446 ~ 0.454	0.593 ~ 0.608	0.977 ~ 1.024	1.539 ~ 1.666	1.904 ~ 2.106	2.785 ~ 3.252	4.420 ~ 5.757	10.707 ~ 25.077	37.070 ~ ∞
f/2.8	0.445 ~ 0.455	0.590 ~ 0.611	0.969 ~ 1.034	1.516 ~ 1.694	1.869 ~ 2.152	2.708 ~ 3.365	4.225 ~ 6.128	9.609 ~ 34.313	26.491 ~ ∞
f/4	0.443 ~ 0.458	0.586 ~ 0.615	0.956 ~ 1.049	1.483 ~ 1.737	1.818 ~ 2.224	2.599 ~ 3.550	3.962 ~ 6.786	8.329 ~ 76.783	18.557 ~ ∞
f/5.6	0.440 ~ 0.461	0.580 ~ 0.622	0.939 ~ 1.070	1.441 ~ 1.799	1.754 ~ 2.329	2.468 ~ 3.832	3.659 ~ 7.922	7.075 ~ ∞	13.268 ~ ∞
f/8	0.436 ~ 0.466	0.572 ~ 0.631	0.915 ~ 1.103	1.383 ~ 1.901	1.667 ~ 2.506	2.294 ~ 4.351	3.284 ~ 10.585	5.774 ~ ∞	9.300 ~ ∞
f/11	0.430 ~ 0.472	0.562 ~ 0.844	0.887 ~ 1.148	1.316 ~ 2.047	1.569 ~ 2.771	2.109 ~ 5.242	2.911 ~ 18.301	4.697 ~ ∞	6.776 ~ ∞
f/16	0.422 ~ 0.482	0.546 ~ 0.667	0.844 ~ 1.231	1.219 ~ 2.348	1.430 ~ 3.386	1.861 ~ 7.978	2.450 ~ ∞	3.588 ~ ∞	4.672 ~ ∞
f/22	0.413 ~ 0.496	0.529 ~ 0.696	0.798 ~ 1.349	1.120 ~ 2.855	1.294 ~ 4.545	1.631 ~ 21.588	2.061 ~ ∞	2.799 ~ ∞	3.410 ~ ∞

unit=feet

Distance scale	1.55'	1.9'	2.5'	3'	6'	8'	12'	25'	∞
f/1.4	1.540' ~ 1.560'	1.884' ~ 1.916'	2.471' ~ 2.530'	2.957' ~ 3.045'	5.814' ~ 6.198'	7.667' ~ 8.364'	11.252' ~ 12.856'	21.905' ~ 29.122'	173.686' ~ ∞
f/2	1.535' ~ 1.564'	1.878' ~ 1.923'	2.459' ~ 2.543'	2.939' ~ 3.064'	5.738' ~ 6.287'	7.533' ~ 8.530'	10.960' ~ 13.262'	20.802' ~ 31.339'	121.623' ~ ∞
f/2.8	1.531' ~ 1.570'	1.869' ~ 1.932'	2.443' ~ 2.560'	2.915' ~ 3.091'	5.640' ~ 6.410'	7.361' ~ 8.763'	10.593' ~ 13.845'	19.495' ~ 34.884'	86.915' ~ ∞
f/4	1.523' ~ 1.573'	1.856' ~ 1.946'	2.419' ~ 2.587'	2.880' ~ 3.131'	5.499' ~ 6.604'	7.118' ~ 9.137'	10.087' ~ 14.824'	17.817' ~ 42.020'	60.884' ~ ∞
f/5.6	1.512' ~ 1.590'	1.839' ~ 1.965'	2.388' ~ 2.624'	2.835' ~ 3.187'	5.322' ~ 6.882'	6.818' ~ 9.690'	9.485' ~ 16.370'	15.986' ~ 57.817'	43.530' ~ ∞
f/8	1.497' ~ 1.608'	1.815' ~ 1.995'	2.343' ~ 2.681'	2.769' ~ 3.275'	5.078' ~ 7.347'	6.414' ~ 10.660'	8.706' ~ 19.414'	13.855' ~ 132.990'	30.514' ~ ∞
f/11	1.478' ~ 1.631'	1.785' ~ 2.033'	2.290' ~ 2.756'	2.692' ~ 3.393'	4.802' ~ 8.027'	5.973' ~ 12.190'	7.898' ~ 25.319'	11.882' ~ ∞	22.231' ~ ∞
f/16	1.447' ~ 1.670'	2.101' ~ 1.737'	2.206' ~ 2.892'	2.573' ~ 3.609'	4.406' ~ 9.500'	5.361' ~ 16.047'	6.845' ~ 51.597'	9.611' ~ ∞	15.329' ~ ∞
f/22	1.413' ~ 1.721'	1.684' ~ 2.188'	2.114' ~ 3.075'	2.445' ~ 3.911'	4.012' ~ 12.205'	4.778' ~ 25.969'	5.906' ~ ∞	7.827' ~ ∞	11.188' ~ ∞

## USING SCREW-MOUNT TAKUMAR LENSES

Super-Takumar and SMC Takumar screw-mount lenses can be attached to your Pentax MG by using the Pentax Mount Adaptor K. When using this accessory, however, the automatic diaphragm of the lens will not longer function and meter readings must be made with the lens aperture stopped down.

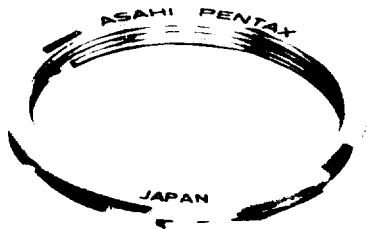

### **Mounting The Adaptor**

Attach the Adaptor K to the lens unit so that it seats firmly in place.



Align the red dot on the Adaptor with the red dot on the camera's lens mount. Insert the lens and rotate the adaptor/lens combination clockwise about 1/4 turn until it clicks into place. The Mount Adaptor K is now fully engaged and screw-mount lenses can be interchanged freely without further adjustments.

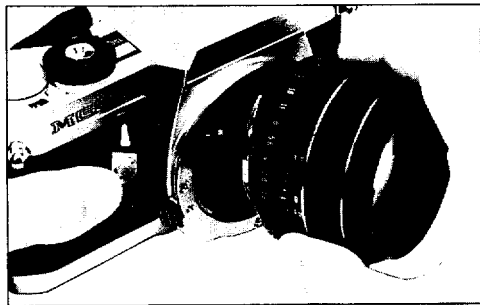

### Removing The Adaptor

After removing the lens, press the adaptor release **A** with your thumbnail or a pointed object such as a ballpoint pen. Turn the Mount Adaptor K counter-clockwise until you feel it release and remove it from the lens mount. Please note that the lens release button **B** serves no function when using this adaptor.

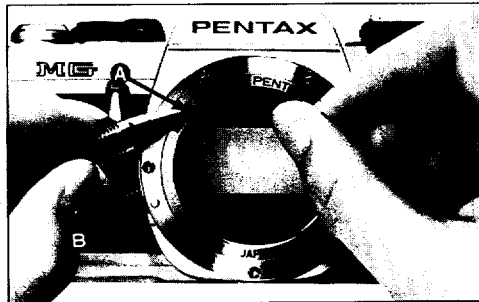

## INFRA-RED PHOTOGRAPHY

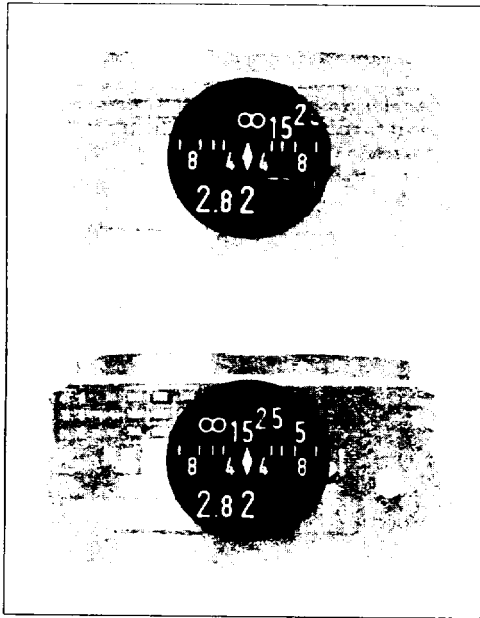

If you intend to take infra-red photographs, remember to use the infra-red mark indicated with an orange line on the depth-of-field scale. First, bring your subject into sharp focus. Then determine the subject-to-camera distance from the distance scale on the lens. Then match your subject-to-camera distance to the infra-red mark by turning the focusing ring accordingly. For instance, if your subject is in focus at infinity, turn the focusing ring and move the infinity ( $\infty$ ) mark to the infra-red mark.

• **NOTE:** An infra-red focusing adjustment is not required when working with infra-red color film.

## OPEN-APERTURE AND STOP-DOWN METERING LENSES

Open-aperture SMC Pentax lenses have a diaphragm coupling lever **A** on the back of the lens which couples with the camera body to permit open-aperture metering. The ultra telephotos do not have a diaphragm coupler, so they must be used with the stop-down metering system. Use of the Auto-Extension Tube Set K permits open-aperture metering. Use of other K Series accessories – standard Extension Tube Set K, Helicoid Extension Tube K, Auto-Bellows M and Bellows Unit III – requires stop-down metering. Whenever any one of these is used between the camera body and an SMC Pentax lens, the stop-down metering system must be used.

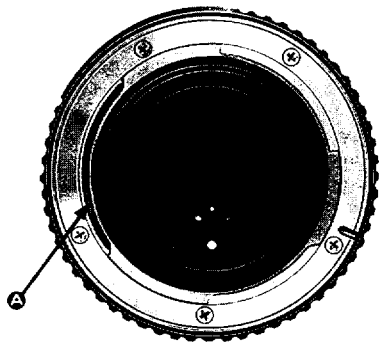

## RESISTANCE TO TEMPERATURE EXTREMES AND VARIATIONS

The temperature range at which your camera will continue to function properly stretches from 50°C to -20°C. However, resistance to cold could be hampered by dirty oil. Therefore, if the camera is to operate at full efficiency in very cold conditions, it must be overhauled and all oil must be replaced. Sudden changes in temperature will often cause moisture to condense inside or outside your camera. This is a possible source of rust, which may be extremely harmful to the mechanism. Furthermore, if the camera is taken from a warm temperature to a sub-freezing one, further damage may result from the formation of icelets.

Thus, sudden temperature changes should be avoided as much as possible. As a guide, a temperature change of 10°C (50°F) should be allowed to take place gradually over a period of at least 30 minutes. If this is not possible, keeping the camera in its case or bag will help somewhat in minimizing the effects of a rapid temperature change.

Extremely low temperature reduces the efficiency of the battery. Therefore, the camera should be protected against low temperature. Put the batteries into the camera right before shooting. In extremely low temperatures, use new batteries.





## CAMERA MAINTENANCE

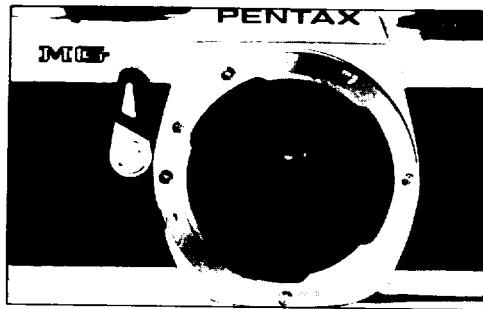

### CLEANING:

- Always keep the viewfinder eyepiece, lens and filters as clean as possible. To remove loose dust and dirt, first use the blower and then the brush of a lens brush. Do not try to wipe off granular dirt or dust — it's an excellent way of scratching the glass.
- Smudges, such as fingerprints, should be carefully wiped away with either lens tissue or a clean, soft cloth. Clean, plain cotton handkerchiefs that have already been washed a few times are particularly good for this. Breathing on the lens before wiping is effective; but be sure to wipe away all moisture completely. Commercial lens cleaners are also effective.
- Never touch the mirror or the shutter leaves. Minor dirt or spots on the mirror will not affect the clarity of your pictures.
- Take care not to drop the camera or knock it against anything solid. Accidents or rough handling can easily damage the internal mechanism, even though externally nothing seems to have been damaged.

### KEEP YOUR CAMERA DRY:

- Your camera is *not* waterproof. There are several places where water can get inside and do a great deal of damage. Take care to protect both body and lens from rain or splashing water. If your camera should get wet, dry it off immediately with a clean, soft cloth.
  
- If your camera becomes completely soaked, it may malfunction. In this instance, bring it as soon as possible to an authorized Pentax service center.

### STORAGE:

- Where to keep your camera while you are not using it is an important point. The best storage place is cool, dry, clean and well-ventilated. Because of the possible build up of humidity, it is risky to store your camera in a cabinet or closet. It's also a good idea to keep your camera in its bag or case while you are not using it.



## METER COUPLING RANGE

The meter coupling range of the Pentax MG assures accurate exposure readings over a broad range of shutter speed/film speed combinations. The working EV range for the auto exposure system varies with the lens being used and is reflected in the adjacent chart. With the 50mm f/2 standard lens with ASA 100 film it runs from EV-3 (f/2 at 1/2 second) to EV-19 (f/22 at 1/1000th second); with the f/1.4 lens, it runs from EV-2 (f/1.4 at 1/2 second) to EV-19 (f/22 at 1/1000th second).

You can calculate what the working EV range would be at other film speeds by mentally adjusting the accurate exposure coupling range. Simply move the ASA arrow at the right of the chart up or down and adjust the chart accordingly. At ASA 50 with the 50mm f/1.4 lens, for example, it runs from EV-1 (f/1.4 at 1 second) to EV-18 (f/22 at 1/500th second; f/16 at 1/1000th second).

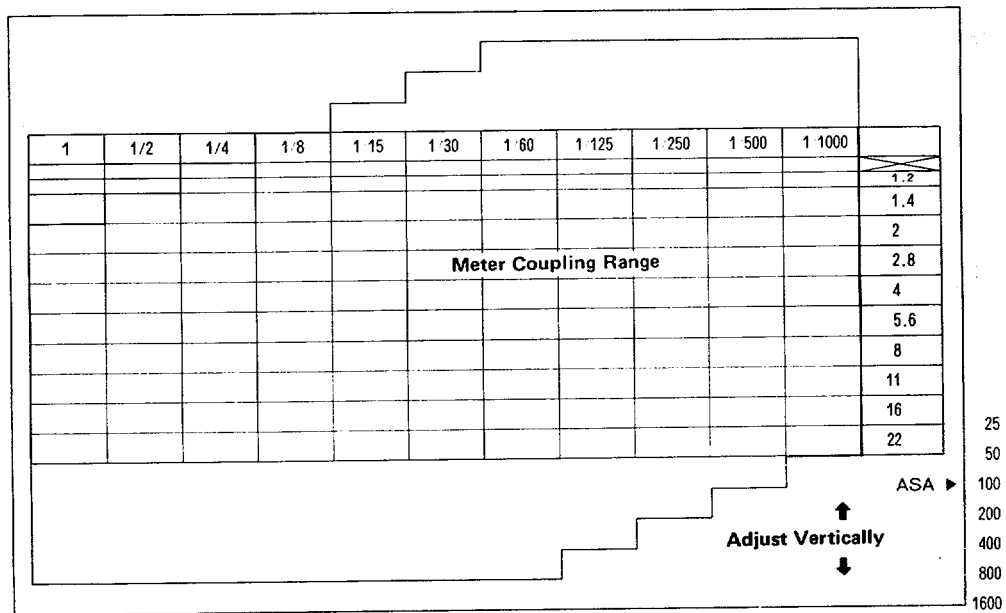

# VIEWFINDER DIAGRAM

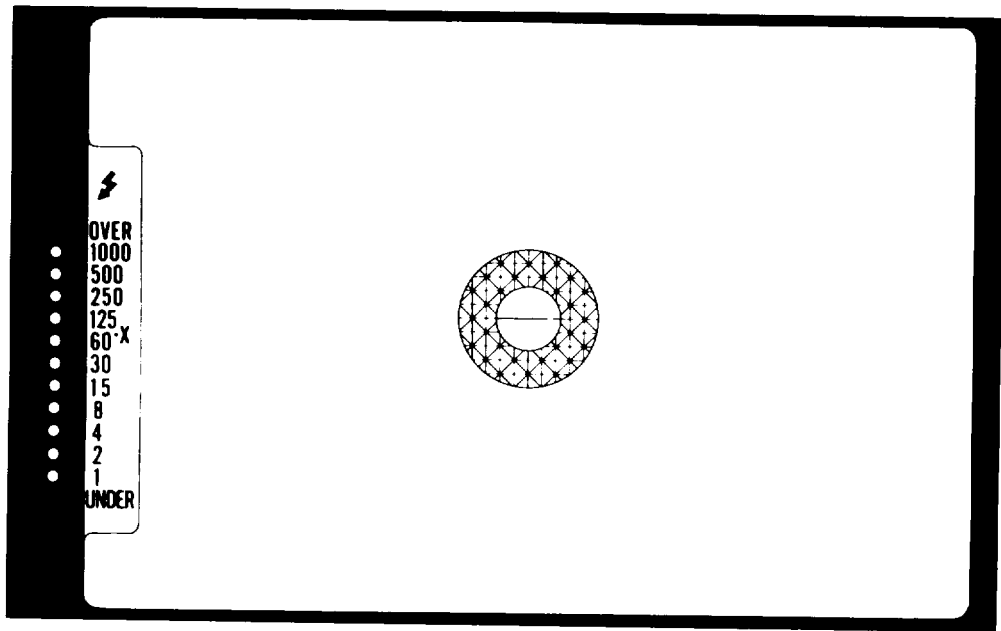

Indication	Color	Function	
	RED	Auto Flash Ready Indicator (flashes red when dedicated Auto Flash has charged).	
OVER	RED	Overexposure Warning (glows red for overexposure).	
1000	GREEN	1/1000 sec. shutter speed setting.	Indications 1/1000 sec. thru 1/60 sec. are given in green to signal adequate speed for handheld shooting.
500	GREEN	1/500 sec.	
250	GREEN	1/250 sec.	
125	GREEN	1/125 sec.	
•X		1/100 sec. (Auto flash synch indicator).	
60	GREEN	1/60 sec.	Indications for speeds 1/30 sec. thru 1 sec. given in yellows as a warning against camera shake.
30	YELLOW	1/30 sec. shutter speed setting.	
15	YELLOW	1/15 sec.	
8	YELLOW	1/8 sec.	
4	YELLOW	1/4 sec.	
2	YELLOW	1/2 sec.	
1	YELLOW	1 sec.	
UNDER	RED	Underexposure Warning (glows for underexposure).	

## SPECIFICATIONS

<b>Type:</b>	Full-frame 35mm single lens reflex camera with aperture-preferred automatic exposure.
<b>Lens mount:</b>	Pentax K-Mount with fully automatic diaphragm lens coupling accepts SMC Pentax lenses, thread-mount lenses with Mount Adaptor K.
<b>Standard lenses:</b>	SMC Pentax 50mm f/1.2, SMC Pentax-M 50mm f/1.4, SMC Pentax-M 50mm f/1.7, SMC Pentax-M 50mm f/2, SMC Pentax-M 40mm f/2.8
<b>Shutter:</b>	Seiko MFC-E vertical-run focal plane shutter; automatic shutter speeds electronically controlled and steplessly varied from 1/1000th to 1 second; plus "100X" and "B" settings.
<b>Dedicated auto flash:</b>	Synchronizes automatically for flash with AF 200S, AF160 and other Pentax dedicated flash units via hotshoe at 1/100th second with dial set to "AUTO." LED flash synch/ready indication inside viewfinder.
<b>Flash synchronization:</b>	X-synchronization via hotshoe on top of camera body with shutter dial at "100X" (cord synchronization via hotshoe adaptor).
<b>Self timer:</b>	Mechanically run with 4 – 10 second delay.
<b>Exposure control:</b>	Open-aperture, center-weighted, through-the-lens light metering by GPD cells. Exposure range from EV-2 to EV-19 (ASA 100, f/1.4); meter activated by light pressure on shutter button, 25 ~ 40 second shutter speed display with automatic shutoff.
<b>ASA range:</b>	ASA 25 – 1600.



<b>Exposure compensation:</b>	Via ASA film speed dial; exposure compensation guides to $\pm 2\text{EV}$ provided beneath film rewind crank.
<b>Viewfinder:</b>	Pentaprism viewfinder with split-image microprism focusing screen; shows 92% of picture area, 0.87X magnification (50mm 1.4 lens), -1.1 diopter eyepiece. Green shutter speed LEDs indicate handholdable shutter speeds from 1/1000th second to 1/60th second, yellow LED camera "shake" warning (1/30th - 1 sec.); red over/under exposure warning; flash synch/ready indicators.
<b>Power source:</b>	Two 1.5-volt silver-oxide batteries, (S-76 or equivalent) or alkaline batteries power shutter and auto exposure systems; LEDs flicker inside viewfinder as low-battery warning.
<b>Film transport:</b>	Pentax Magic Needle Loading System; single-stroke rapid wind lever with 135° throw and 30° standoff angle; built-in shutter cocked indicator; accepts Winder ME-II and Winder ME for automatic film advance.
<b>Film rewind:</b>	Crank-type. Film rewind button doubles as multiple exposure button to disengage film advance mechanism.
<b>Mirror:</b>	Swing-back, instant return type.
<b>Camera back:</b>	Standard back; interchangeable with cordless dial data unit to be marketed; Dial Data ME also usable with hotshoe adaptor.
<b>Other features:</b>	Tripod socket, strap hooks; accepts wide range of Pentax lenses and system accessories, including close-up copy and special-purpose adaptors.
<b>Size:</b>	132mm x 85mm x 49.5mm.
<b>Body weight:</b>	423g (without batteries).

## WARRANTY POLICY

All Pentax cameras purchased through authorized bona fide photographic distribution channels are guaranteed against defects of material or workmanship for a period of twelve months from date of purchase. Service will be rendered and defective parts will be replaced without cost to you within that period, provided the equipment has not been abused, altered, or operated contrary to instruction. Because the tolerances, quality, and design compatibility of lenses other than Pentax lenses are beyond our control, damage caused by use of such lenses will not be covered by this warranty policy. The manufacturer or its authorized representatives shall not be liable for any repair or alterations except those made with its written consent and shall not be liable for damages from delay or loss of use or from other indirect or consequential damages of any kind, whether caused by defective material or workmanship or otherwise; and it is expressly agreed that the liability of the manufacturer or its representatives under all guarantees or warranties, whether expressed or implied, is strictly limited to the replacement of parts as hereinbefore provided.

### **Procedure During 12-month Warranty Period**

Any Pentax which proves defective during the 12-month warranty period should be returned to the dealer from whom you purchased the equipment or to the manufacturer. If there is no representative of the manufacturer in your country, send the equipment to the manufacturer, with postage prepaid. In this case, it will take a considerable length of time before the equipment can be returned to you owing to the complicated customs procedures required in Japan in importing and re-exporting photographic equipment. If the equipment is covered by warranty, repairs will be made and parts replaced free of charge, and the equipment will be returned to you upon completion of servicing. If the equipment is not covered by warranty, regular charges of the manufacturer or of its representatives will apply. Shipping charges are to be borne by the owner. If your Pentax was purchased outside of the country where you wish to have serviced during the warranty period, regular handling and servicing fees may be charged by the manufacturer's representatives in that country. Notwithstanding this, your Pentax returned to the manufacturer will be serviced

free of charge according to this procedure and warranty policy. In any case, however, shipping charges and customs clearance fees are to be borne by the sender. To prove the date of your purchase when required, please keep the receipts or bills covering the purchase of your equipment for at least a year. Before sending your equipment for servicing, please make sure that you are sending it to the manufacturer's authorized representatives or their accredited repair shops, unless you are sending it directly to the manufacturer. Always obtain a quotation of the service charge, and only after you accept the quoted service charge, instruct the service station to proceed with the servicing.

**This warranty policy does not apply to Pentax products purchased in the U.S.A., U.K., or Canada. The local warranty policies available from Pentax distributors in those countries supersede this warranty policy.**



**Asahi Optical Co., Ltd.** C.P.O. 895, Tokyo 100-91, JAPAN  
**Asahi Optical Europe N.V.** Weveldlaan 3-5, 1930 Zaventem Zuid-7, BELGIUM  
**Pentax Handelsgesellschaft mbH.** 2000 Hamburg 54 (Lokstedt), Grandweg 64, WEST GERMANY  
**Pentax Corporation** 35 Inverness Drive East, Englewood, Colorado 80112, U.S.A.  
**Pentax Canada Inc.** 1760 West 3rd Avenue, Vancouver, B.C. V6J 1K5, CANADA  
**Pentax U.K. Limited** Pentax House, South Hill Avenue, South Harrow, Middlesex HA2 0LT, U.K.  
**Pentax France S.A.** 72-76 Rue Paul, Vaillant Couturier, 92300 Levallois Perret, FRANCE  
**Asahi Optical Brasileira Ind. e Com. Ltda.** Rua Estados Unidos, 1053, São Paulo-SP, BRASIL