

PENTAX®

ZX-7

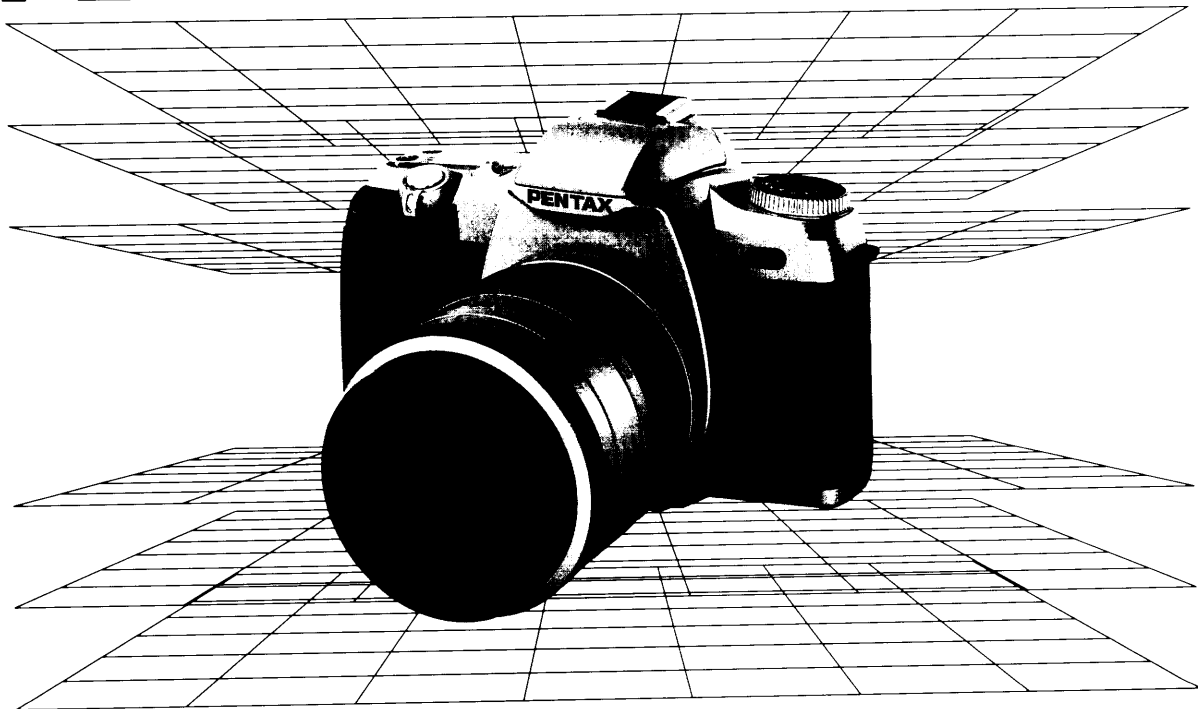





OPERATING MANUAL



Congratulations on your purchase of this camera and welcome to the exciting world of Pentax autofocus photography! This compact and light weight camera is an autofocus SLR camera that offers higher levels of sophistication and performance. Incorporating a broad range of advanced technologies and highly accurate automation, this camera will perform superbly for the most exacting photographer.

- Read this instruction manual carefully to get a full explanation of operations before use.
- Illustrations in this operating manual are the data function.

Icon indicators used in this manual

Operation direction	
Automatic operation	
Attention	
Lamp blinking	
Correct	
Incorrect	

Lenses and accessories produced by other manufacturers are not made to our precise specifications and therefore may cause difficulties with, or actual damage to, your Pentax camera. We do not assume any responsibility or liability for difficulties resulting from the use of lenses and accessories made by other manufacturers.

FOR SAFE USE OF YOUR CAMERA

1

Although we have carefully designed this camera for safe operation, please be sure to follow precautions given on this page.

⚠ WARNING This mark indicates precautions that, if not followed, could result in serious injury to the operator.

⚠ CAUTION This mark indicates precautions that, if not followed, could result in minor or medium injury to the operator or damage to the equipment.

⚠ WARNING

- The electronic circuits inside the camera contain high voltage working parts. Never attempt to disassemble the camera yourself.
- Never touch internal parts of the camera if they become exposed from dropping the camera or for some other reason, as there is danger of an electric shock.
- Wrapping the strap around your neck is dangerous. Make sure that small children do not get the strap caught around their neck.
- Do not look directly at the sun through the camera, as viewing the sun for may damage your eyes, and/or parts of the camera (e.g: shutter blades, etc.)
- Be sure to store batteries out of the reach of children. Seek medical assistance immediately if accidentally swallowed.

⚠ CAUTION

- Do not use the flash near anyone's eyes, as it may hurt them. Be particularly careful with the flash around infants.
- Never try to disassemble, short or recharge the battery. Also, do not dispose of the battery in fire, as it may explode.
- Remove the batteries from the camera immediately if they become hot or begin to smoke. Be careful not burn yourself during removal.

PRECAUTIONS FOR YOUR CAMERA

Your Pentax camera is a high-precision mechanism. Handle it with great care.

Precautions when taking pictures

- Do not use the camera where it may come in contact with rain, water, or any other liquid, because the camera is not weather, water, or liquid resistant. Should the camera get wet from rain, splashing water, or any other liquid wipe it off immediately with a dry soft cloth.
- Do not drop the camera or allow it to hit solid objects. If the camera suffers a shock or impact, take it to a Pentax service center for inspection.
- Be careful not to subject the camera to strong vibrations, shock or pressure. Use a cushion to protect the camera when carrying it in a motorcycle, car, boat, etc.
- Condensation on the interior or exterior of the camera may be extremely harmful to the camera mechanism as it may cause rust. Furthermore, if the camera is taken from warm temperature to a subfreezing one or vice versa, the formation of icelets may cause damage. In such a case, put the camera into a case or plastic bag so that any changes in temperature difference is minimized. Do not remove it from the bag until temperature has stabilized.
- Regular size color prints may cut off what appears on the extreme edges of the film frame. Compose your picture with a margin of safety at the edges.

Precautions for storage

- Avoid leaving the camera for extended periods in places where the humidity and temperature are very high, such as in a car.
- Do not store the camera in a closet with moth balls or in an area where chemicals are handled. Store it in a place with good dry air circulation to prevent the growth of fungus.

Precautions for proper care

- Never touch the shutter curtain or mirror with your finger or any other object.
- Use a blower and lens brush to remove dust accumulated on the lens or viewfinder.
- Never use solvents such as paint thinner, alcohol or benzene to clean the camera.
- Electrical problems may often be caused by water, dirt or dust at points of electrical contact. Also check for battery leakage, traces of dirt or grease, or corrosion due to salinity or gas. If you cannot correct the problems, have your camera inspected at a Pentax service center. Repairs of this nature are not covered under the terms of the warranty and charges may be assessed.

Other precautions

- The temperature range at which this camera functions properly is 50°C to -10°C (122°F to 14°F).
- A camera which has been submerged in water usually cannot be repaired. If such an accident should occur, it is advisable to contact a Pentax Service Center immediately.
- To maintain optimum performance, it is recommended that the camera be inspected every one or two years. If the camera has not been used for an extended period, or is being prepared for an important photographic session, it is recommended that you have the camera inspected or test shoot with it.
- Repairs deemed necessary due to usage of this product in an industrial or commercial application may not be covered under the terms of the Pentax warranty.
- The PENTAX warranty provides only for the repair of defects in materials or workmanship. Damage of any kind cannot be repaired at no charge under the terms of the warranty. If the difficulty is caused as a direct result of the product being used in conditions as outlined in the "Precautions for Your Camera" section or any other operation contrary to the instructions outlined in this manual, charges will be assessed and a repair quotation will be provided.

- Use two 3V lithium batteries (CR2 type).
- Misuse of the battery can cause hazards such as leakage, overheating, explosion, etc. The battery should be inserted with the "+" and "-" sides facing correctly.
- Battery performance may be temporarily hindered in low temperatures, but will recover in normal temperatures.
- Keep a spare battery on hand for replacement convenience when shooting outdoors or while traveling.
- If the built-in flash is used continuously, the battery may become warm, but it does not mean that the battery is faulty; it is one of the battery's characteristics.
- Replace the batteries at the same time. Do not mix battery brands, type or an old battery with a new one. It may cause explosion or overheating.

TABLE OF CONTENTS

Safe use of your camera	1	II BASIC OPERATION (SHOOTING)	23-36
Precautions for your camera	2	Using the Auto Picture Mode	24
Precautions for battery usage	3	Using the Smart Flash	25
Table of contents	4	• Auto-popup flash function	25
Names of working parts	6	• Flash disable function	26
LCD panel indication	8	Using zoom lenses	27
Viewfinder indication	9	Setting the Single-Frame Drive Mode	28
• Multi (6) - segment metering	9	Selecting the Autofocus Mode	28
Camera functions available with various lenses	10	Holding the Camera	29
I. BASIC OPERATION (PREPARATION)	11-23	Taking a picture	30
Attaching the camera strap	11	Selecting the various flash Modes	32
Loading the batteries	12	• AF illuminator	33
• When the battery is exhausted	13	• About Red-eye Reduction Flash Function	33
Attaching the lens	14	Activate the built-in flash in manual	34
Turning on the power	16	Flash recommended warning	36
Operating the shutter release button	16		
Using the data back	17		
Film loading	18		
Unloading film	21		
• Rewinding a film in mid-roll	22		

III ADVANCED OPERATION	37-81
Selecting a Drive Mode	37
• Consecutive Frame Mode	38
• Self-Timer Mode	38
Remote control shooting (Optional)	40
• 3-second-delay release mode	40
• Instant release mode	42
Multiple-Exposure Mode	43
Taking a panorama format picture	44
Using the Picture Mode	46
• Green Operation Mode	47
• Portrait Program Mode	48
• Landscape Program Mode	49
• Close-up Program Mode	50
• Action Program Mode	51
• Night-scene Program Mode	52
Selecting an Exposure Mode	53
• Using the Aperture-Priority AE Mode	54
• Using the Shutter-Priority AE Mode	56
• Using the Metered Manual Mode	58
• Bulb Exposure Mode	60
About Exposure Compensation	61
Turning off the audible PCV signal	62
Memory lock function	63
Manual focusing	64
• Using the snap-in focus function	65
• Hard-To-Autofocus Subjects	66
Advanced operation for the Built-in Retractable Flash (RTF)	67
• Compatibility of F and FA lenses with the built-in flash	69
Setting the film speed (ISO) manually	70
Adjusting the Data Back	71
Installing the battery in the Data Back	73
Using a Pentax Dedicated External Flash	74
• Contrast-Control-Sync Flash Photography	75
• Overview of flash function	76
Daylight-sync shooting	77
Slow-shutter-sync shooting	78
ACCESSORIES (OPTIONAL)	79
Camera case scale	80
Depth of field scale	81
IV. OTHERS	82-88
Troubleshooting	82
Specifications	84
Program lines	86
Warranty policy	88

NAMES OF WORKING PARTS I

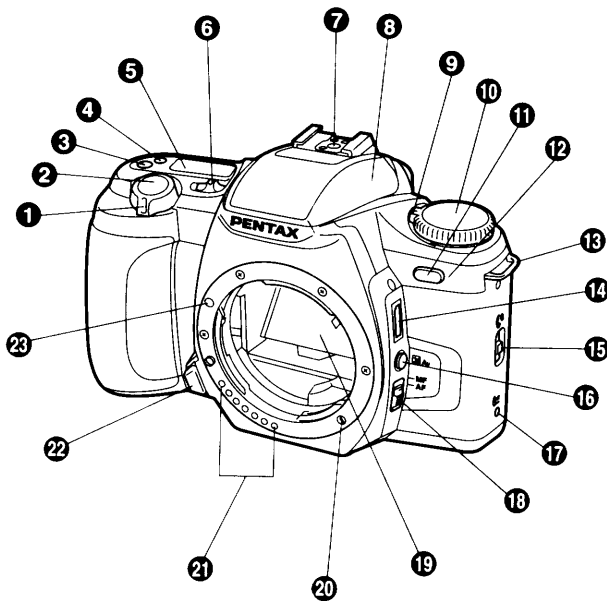

- ❶ Select switch
- ❷ Shutter release button
- ❸ Drive mode button (p.37, 38, 40, 42, 43)
- ❹ Flash mode button (p.24)
- ❺ LCD panel
- ❻ Main switch (p.16)
- ❼ Hot shoe
- ❽ Built-in flash
- ❾ Exposure mode indicator
- ❿ Mode dial
- ⓫ Remote control receiver (p.38, 40, 42)
- ⓬ Self-timer lamp (p.38, 40, 42)
- ⓭ Strap lug (p.11)
- ⓮ Release socket
- ⓯ Back cover release lever (p.18)
- ⓰ Exposure compensation button (p.62)
- ⓱ Mid-roll rewind button (p.22)
- ⓲ Focus mode switch (p.28, 65)
- ⓳ Mirror
- ⓴ AF coupler
- ⓵ Lens information contacts
- ⓶ Lens lock button (p.14)
- ⓷ Lens mount index





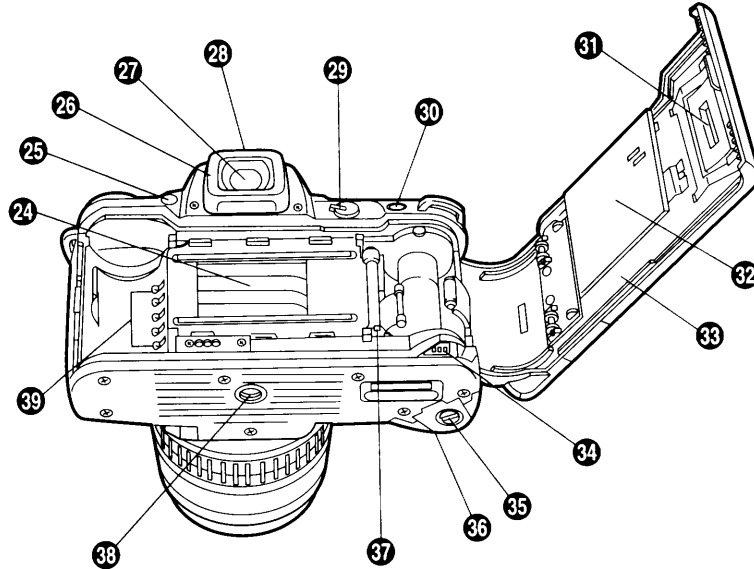



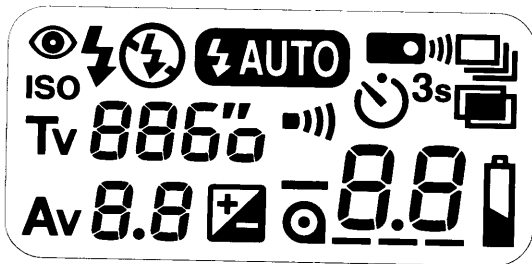

NAMES OF WORKING PARTS II

- 24 Shutter curtains
- 25 Flash mode button (p.32)
- 26 Eyecup FK (p.39)
- 27 Viewfinder eyepiece
- 28 Diopter adjustment lever (p.23)
- 29 Panorama lever (p.44)
- 30 Memory lock button (p.63)
- 31 Film information window
- 32 Pressure plate
- 33 Back cover (p.18)
- 34 Film leader end mark (p.19)
- 35 Battery cover chamber screw (p.12)
- 36 Battery chamber cover (p.12)
- 37 Sprocket (p.19)
- 38 Tripod socket
- 39 DX-information (p.19)





LCD PANEL INDICATION



-  : Flash information (p.25, 36)
-  : Red-eye reduction flash indication (p.32)
-  : Automatic flash information (p.25)
- ISO** : Manual-set film speed (p.70)
- TV 886** : Shutter speed
-  : Battery exhaustion warning (p.13)
-  **3s** : Remote control release with a 3-sec. delay (p.40)
-  : Audible PCV signal (p.62)
-  : Consecutive shooting (p.38)
-  : Remote control release (p.40,42)
-  : Self-timer (p.38)
-  : Multiple-exposure shooting (p.43)
- Av 8.8** : Aperture value

All indications will not actually appear simultaneously as shown.

- Under the dim light condition, the LCD panel will be illuminated automatically.

-  : Exposure compensation (p.61)
-  : Film status information (p.20, 22)
- 88** : Exposure counter (p.20) and exposure compensation value (p.61)

LCD (Liquid-Crystal Display)

When the LCD is exposed to high temperatures over approximately 60°C, it may blacken, but when the temperature normalizes, it should return to normal.

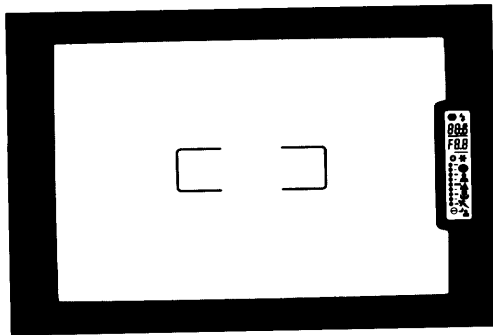

[C]: 3-point AF frame (p.30)

BBB : Shutter speed

F8.8 : Aperture value

☺ : Green Operation Mode (p.47)

👤 : Portrait Operation Mode (p.48)

🏞️ : Landscape Program Mode (p.49)

🌸 : Close-up Program Mode (p.50)

📷 : Action Program Mode (p.51)

🌃 : Night-scene Program Mode (p.52)

⚡ : Flash status information (p.32,36)

🎯 : In-Focus indicator (p.65)

* : Memory lock (p.63)

📊 : Bar graph (p.58, 61)

MULTI (6)-SEGMENT METERING

This camera incorporates six-segment TTL metering system. Light values are measured in six segments within the image field, enabling an optional exposure to be made under a variety of lighting conditions. With multi(6)-segment metering, the camera records the brightness in six zones within the image field and will properly expose the subject. The multi (6)-segment metering system also calculates exposure values for a scene to automatically compensate for high-contrast and other difficult lighting conditions. Even a beginner can achieve results with ease.

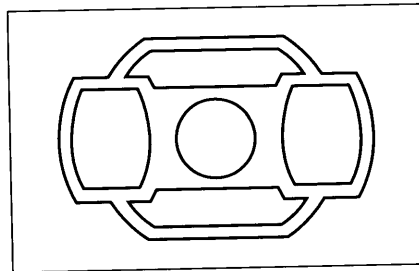

- When the format is switched to panorama, the viewfinder switches to the horizontal panorama format frame. For details on panorama format picture taking, see page 44.

CAMERA FUNCTIONS AVAILABLE WITH VARIOUS LENSES

Function	Lens [Mount type]	FA lens [K _{AF2}]	F lens [K _{AF}]	A lens [K _A]	M lens [K]	S lens [Screw]
Autofocus (Lens only) (Lens with AF Adapter 1.7X)		○	○	x	x	x
3-point autofocus		-	-	○*1	○*1	x
Manual focus (with FI) (with Matte field)		○	○	x	x	x
		○*3	○*3	○*3	○*3	x
		○	○	○	○	○
Power zoom		x	x	x	x	x
Image size tracking		x	x	x	x	x
Zoom clip		x	x	x	x	x
Auto zoom effect		x	x	x	x	x
Picture Mode		○*4	○*4	○	x	x
Auto Picture Mode		○*4	○*4	x*5	x	x
Aperture-Priority AE		○	○	○	○	○
Shutter-Priority AE		○*5	○*5	○	○	○
Manual Exposure		○	○	○	○	○
Auto-popup built-in flash mode *6		○	○	○	x	x
Programmed TTL Auto Flash		○	○	○	x	x
TTL Auto Flash		○	○	○	○	○
Multi(6)-segment metering		○	○	○*7	x*8	x*8
Approx. f-stop indication		○	○	x	x	x

Notes:

- *1. Lenses with a maximum aperture of f/2.8 or larger. (See AF Adapter operating manual.)
 *2. Manual focusing using the focus indicator (FI) (●) in the viewfinder. *3. Lenses with a maximum aperture of f/5.6 or larger.
 *4. Exception of Pentax-F or FA Soft 85mm/f2.8. *5. Green Operation Mode only
 *6. Auto Picture Mode and Green Operation Mode only.
 *7. When the 50mm f/1.2 lens is in use with the lens aperture ring set at a position other than the A position, the center-weighted metering mode will be set. As the exposure will come out 1 stop overexposed, adjust the exposure deliberately 1 stop under.
 *8. The center-weighted metering

• K_{AF2} and K_{AF} mount lenses are designed to work with the Autofocus SLR camera.

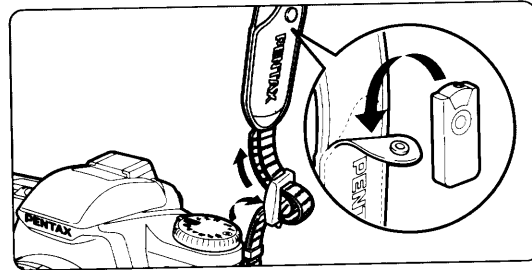

Fit the strap on the camera as illustrated.

- There is a pocket on the strap so you can store the remote control transmitter, finder cap, release socket cover, hot shoe cover or any other small accessory as illustrated.

I. BASIC OPERATION (PREPARATION)

LOADING THE BATTERIES

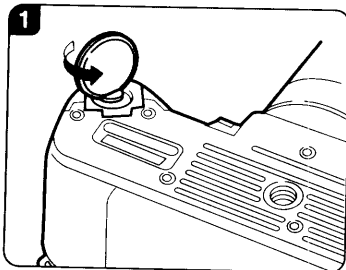

1. Open the battery chamber cover by using a coin, etc. as shown in the illustration.

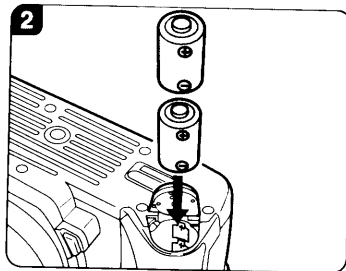

2. Load two 3V lithium batteries (CR2) or equivalent as shown in the illustration.

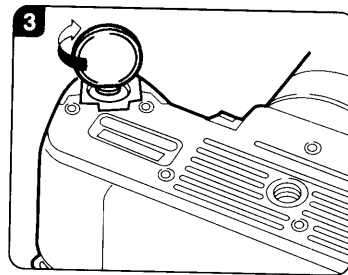

3. Turn the battery chamber cover screw in the direction of the arrow to lock it securely.

- When the batteries are replaced, the camera settings such as the audible PCV signal switching, exposure compensation value, red-eye reduction flash function, self-timer, remote control and auto-popup flash function of the built-in flash will be re-set.
- The optional "AA-Battery Pack FG" is also available for this camera instead of using the lithium batteries.
- Replace two batteries at the same time. Do not mix battery brands, type or an old battery with a new one. It may cause explosion or overheating.

Battery Life (using 24-exposure film rolls at 20°C/68°F)

General existing light photography	about 120 rolls
Flash photography (using flash 50% of the times)	about 20 rolls
Flash photography (using flash 100% of the times)	about 12 rolls
Bulb exposure time	about 8 hours

Battery Life (using 24-exposure film rolls at -10°C/14°F)

General existing light photography	about 30 rolls
Flash photography (using flash 50% of the times)	about 15 rolls
Flash photography (using flash 100% of the times)	about 5 rolls
Bulb exposure time	about 2 hours

CR2 batteries were used under Pentax testing conditions. Actual battery life and performance may vary drastically depending on usage of Autofocus, and external conditions such as temperature and freshness of the battery.

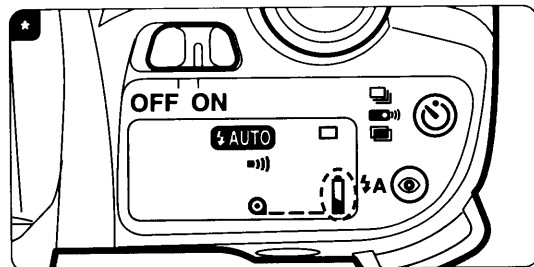

* Low Battery Warning

When the batteries are nearly exhausted, the battery symbol [] appears on the LCD panel to warn you. Replace the batteries as soon as possible.

- Even if the low-battery symbol appears, exposure will be correct as long as the shutter can be released. It is recommended to replace the batteries as soon as possible.
- When the low battery warning [] starts blinking, the shutter cannot be released and all indicators in the viewfinder disappear.

ATTACHING THE LENS

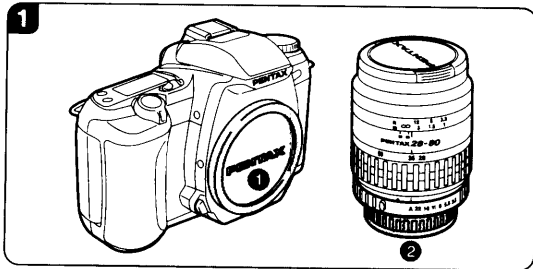

1. Remove the body mount cap ① and rear lens cap ② as shown in the illustration.

- The body mount cap is designed to protect the camera against scratches and dust at the factory. For storage, the optional accessory "Body Mount Cap K" is available.

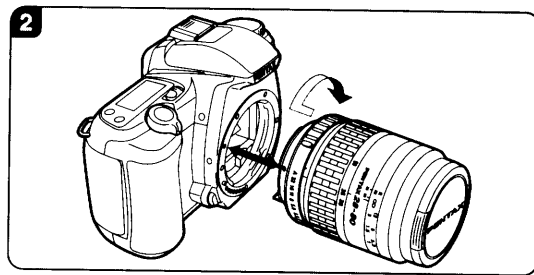

2. Align the red dots on the camera and lens mount, attach the lens to the camera body, and turn it fully to the right until you hear a click.

- Ensure that the camera's main switch is in the [OFF] position before attaching an FA zoom lens to prevent unexpected operation of the lens.

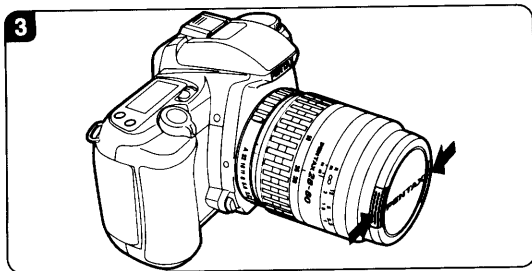

3. To remove the front lens cap, squeeze the tabs on both sides in the direction of the arrow.

- We assume no responsibility nor liability for damages resulting from the use of lenses made by other manufacturers.
- The camera body and lens mount incorporate lens information contacts and an AF coupler. dirt, dust, or corrosion may cause damage to the electrical system. Clean the contacts with a soft, dry cloth.

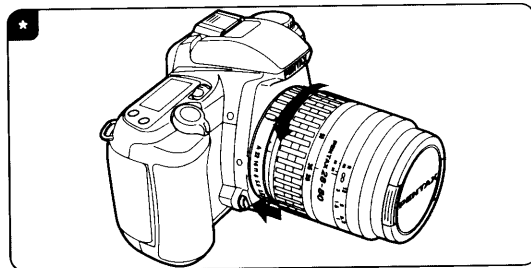

*** How to remove**

To remove the lens, turn it to the left while depressing the lens-lock-release button.

- To protect the contacts and AF coupler of the lens against damage after removal, be sure to set the lens down with the mount side facing upward.

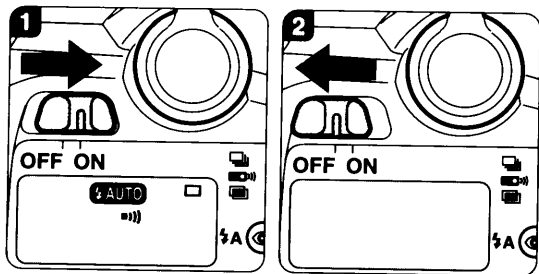

1. The power is turned ON when the main switch is set to ON.
 2. The power is turned OFF when the main switch is set to OFF.
- When the power is turned on with the Auto picture or Picture Mode set, the mode dial lights up progressively. To cancel this function, set the mode dial to [M]] and reinstall the battery. To light up the mode dial again, the same procedure as cancellation is required.
 - When not in use, ensure that the main switch is set to OFF.

OPERATING THE SHUTTER RELEASE BUTTON

The shutter release button has two positions. Depressing it down halfway (first position) turns on the exposure meter and autofocus system.

Depressing it fully (second position) releases the shutter. When taking a picture, depress the shutter release button gently to prevent camera shake.

- To prevent camera shake, depress the shutter release button gently.
- Before loading a roll of film, slowly depress the shutter release button to learn where the first position is.
- The LCD indication stays on for about 10 seconds after the button is released from the halfway position. Depressing the shutter release button down halfway keeps the LCD indicator on.

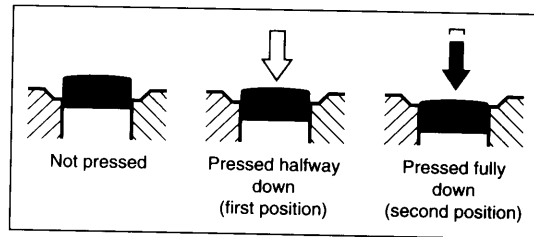

THE DATA BACK (optional)

If you have purchased your camera as the Date version, read this section.

The DATE model records data information on your photographs clearly on each frame that you expose.

At each press of the DATE button as shown in the illustration, the mode on the LCD panel of the Data Back switches as indicated in the chart.

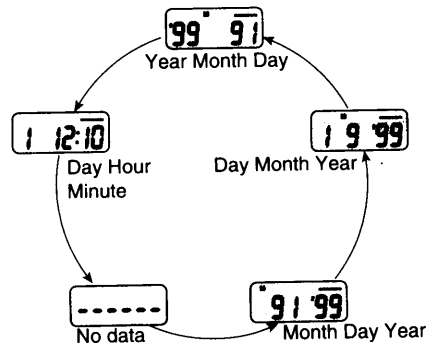

- [M] on the LCD indicates "Month".
- Year 2000 will imprint [00] on pictures.
- As shutter is released, the bar mark [-] in the display blinks for a few seconds that the data has been imprinted.

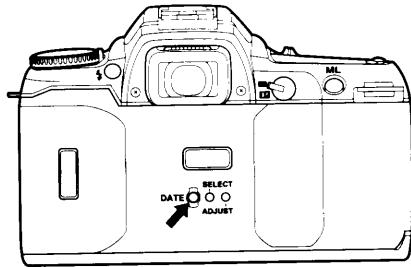

- [— — —] indicates that no data will be imprinted.
- If there is a white or yellow object in the corner of the picture where the data is imprinting, the data may be difficult to read. When composing your photograph, try to avoid brightly-colored subject in that corner.
- The dating unit automatically switches the imprint mode between the standard and panorama according to the format selected.
- To adjust the data, see page 72.
- The data back operates on a 3V lithium battery. If the data imprinted on the picture or the data displayed on the LCD panel become weak or invisible, the battery may need replacing. To replace the battery see page 73.

FILM LOADING

BASIC OPERATION (PREPARATION)

We suggest that you first operate the camera with no film loaded to become familiar with its operations.

Automatic film speed setting

This camera is designed to use DX-coded films with ISO ratings from 25 to 5000.

- When DX-coded film is used, the correct film speed is automatically set for the camera. If you use a non-DX coded film, you can set the film speed manually. See page 70.
- Before loading film for the first time after purchase, open the back cover and remove the protective card. **DO NOT TOUCH THE SHUTTER CURTAINS.**

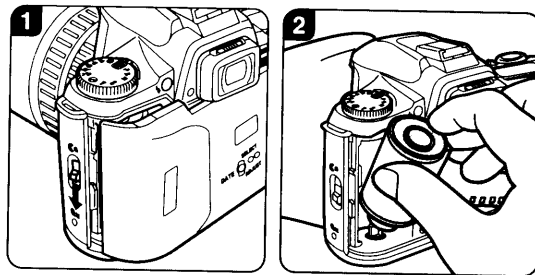
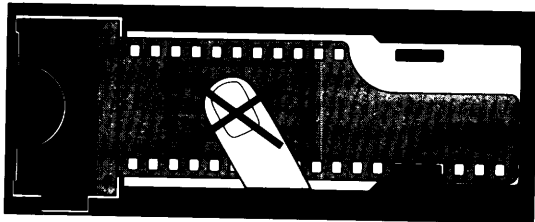

1. To open the back cover, slide the back cover release lever in the direction of the arrow.
2. Place the film cartridge in the film chamber as shown in the illustration.

- Always load and unload film in the shade or by using your body to shade the camera.

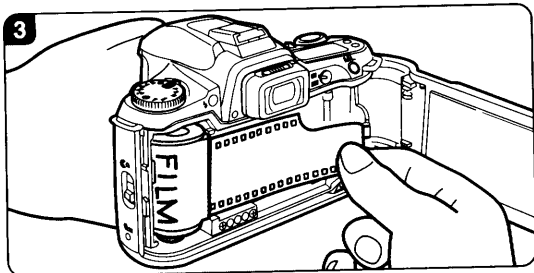

3. As shown in the illustration, pull the film leader out only far enough to reach the take-up spool.

THE SHUTTER CURTAINS ARE FINE-PRECISION MATERIAL. DO NOT TOUCH THEM WITH YOUR FINGERS OR ANY OTHER OBJECT WHILE LOADING FILM.

- If you have pulled out too much film, push it back into the cartridge to reduce the slack.
- The DX information pins in the film chamber are used to read film speed. Keep them clean and free from scratches. To remove smudges, wipe them gently with a soft, dry cloth.

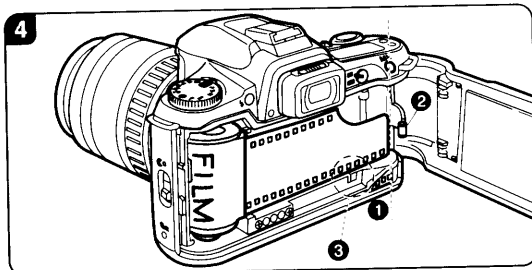

4. Align the film leader with the film leader end mark ① as shown.

- Make sure that the film leader is positioned under the film retainer ② as shown in the illustration.
- Make sure that the film perforations properly engage on the sprocket tooth ③.
- If the end of the film leader is extremely bent, straighten it or cut off the bent portion.

Film loaded with slack No!

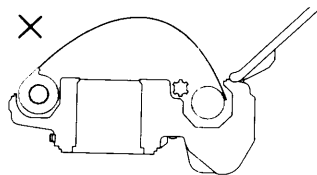

Film loaded flat Yes!

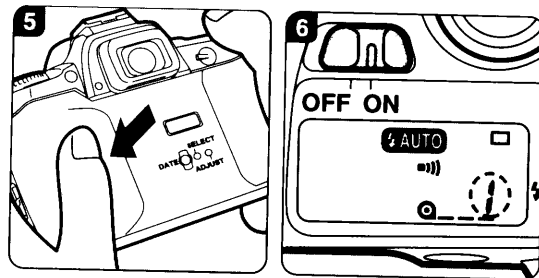
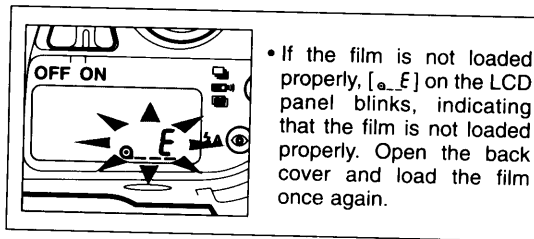
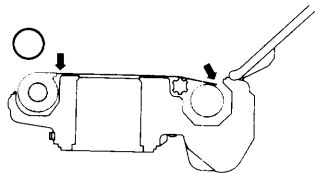

5. Close the back cover and set the main switch to ON.

6. The film automatically advances to the first frame.

- Check that [] and [@_] are displayed on the LCD panel.
- The film counter indication advances one each time the shutter is released.

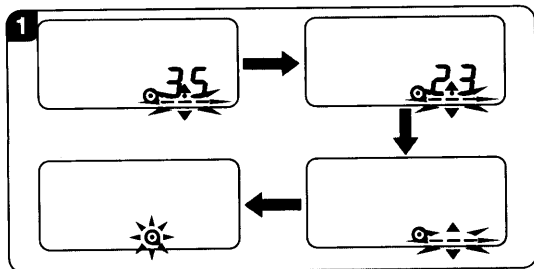

1. The film automatically rewinds at the end of the roll.

- During rewinding, [—] blinks on the LCD panel, indicating that the film is being rewound, the exposure counter counts frame numbers in reverse.
- Never open the back cover until the whole film roll is completely rewound.
- When removing the film from the camera, protect it from exposure to direct sun light.

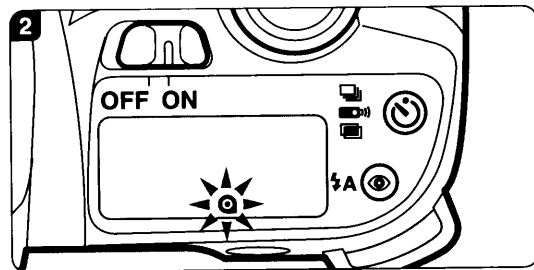

2. When the film is fully rewound, only [☉] blinks on the LCD panel.

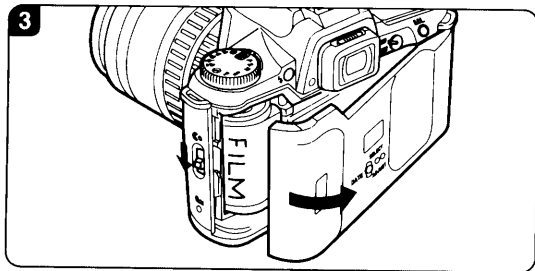

3. Open the back cover and remove the film.

- A roll of 24-exposure film takes about 13 seconds to rewind.
- Before opening the back cover, check that [] is blinking.
- The shutter may be released a frame or more after the specified number of frames have been used as indicated by the number of frames on the film cartridge. However, those extra frames may be lost in processing. When you take important pictures, rewind the film when the film reaches the number of frames indicated on the film cartridge.

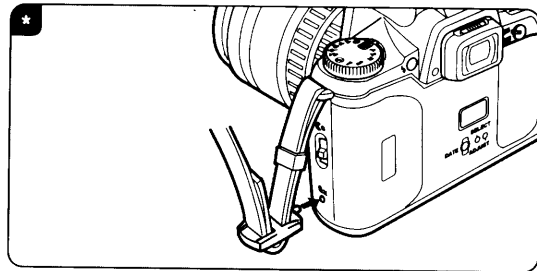

* Rewinding a film in mid-roll

If you wish to unload the film before exposing all the frames, use this function.

Set the main switch to the ON position, and then depress the mid-roll rewind button by using the protruding part of the strap clamp.

- Do not depress the button with an object having a sharp tip.
- Before opening the back cover, check that [] is blinking.

ADJUSTING THE VIEWFINDER DIOPTER

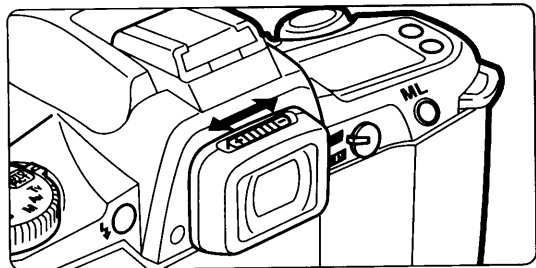

Aim the camera at a bright subject. While looking through the viewfinder, move the diopter adjustment lever to the left or right until the autofocus frame [C] appears in the sharpest focus.

II. BASIC OPERATION (SHOOTING)

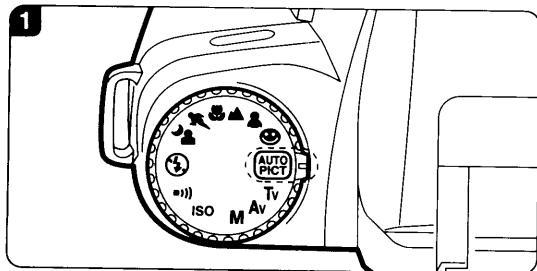

This Auto Picture Mode allows you to take pictures by simply depressing the shutter release button. In this mode, the camera automatically selects one of 5 picture modes according to the requirement of the scene.

How to set

1. Set the mode selection ring to the [**AUTO PICT**] position.
2. Turn the lens aperture ring to the [**A**] position.

- To move the lens aperture ring to the [**A**] position, turn the aperture ring while holding down the aperture-A lock button on the lens. The lens aperture ring can be released from the [**A**] position in the same manner.

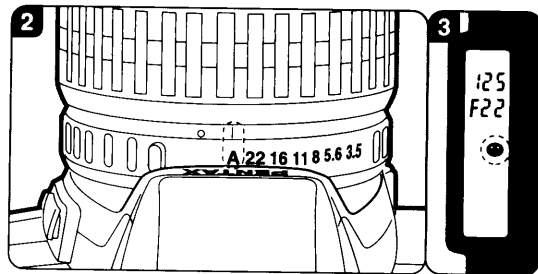

3. The selected picture mode is displayed in the viewfinder.

- The Auto Picture Mode operates only when an FA or F lens is attached. The Green Operation Mode operates only with an A-lens attached.
- See page 54 to 60 for any other exposure mode.
- The memory lock function or exposure compensation function cannot use when the Auto Picture Mode is in use.

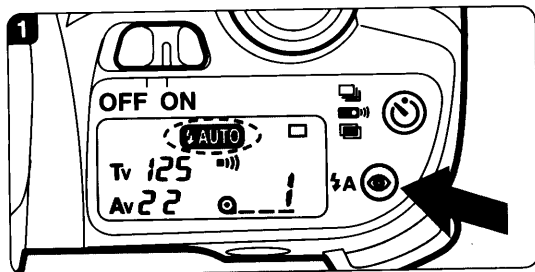

Auto-popup flash function

1. Depress the flash mode button until [**AUTO**] appears on the LCD panel.

The auto-popup flash function operates only when the Auto Picture Modes or Picture Mode is set.

- The Built-in flash does not retract automatically.
- The built-in flash does not discharge when not required even though it has been in the up position.
- See page 32 for more details.
- [**AUTO**] cannot be cancelled with the Auto Picture Mode set.

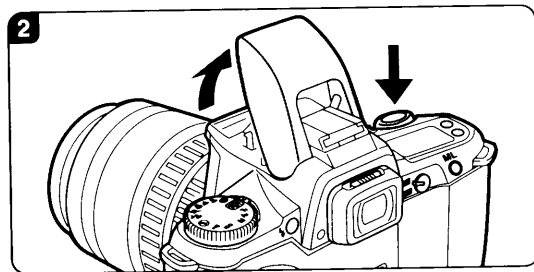

2. The built-in flash automatically pops up when depressing the shutter release button halfway down in the following conditions.

1. low light situation
2. backlit situation

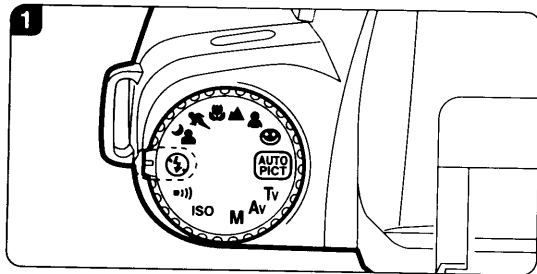

Flash Disable Mode

Use this mode if you don't want the built-in flash to pop-up automatically. The flash will not pop-up automatically even when it is dark nor lights when the flash is in the up position.

1. Set the mode dial to [⚡].
2. [⚡] appears on the LCD panel.

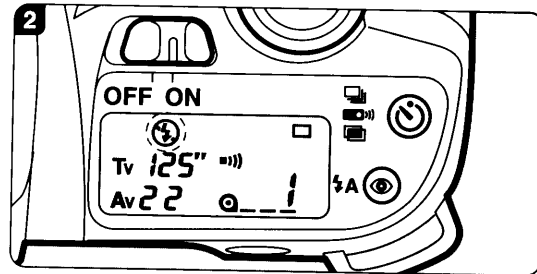

- From among 5 modes, the camera selects the best one depending on the size of the subject and some other factors. The flash disable mode is the same as the Auto Picture Mode except that the built-in flash does not pop up.
- In the flash disable mode, the external flash will not discharge either.
- When the lens aperture ring is set to other than [A] with the mode dial set to [⚡], the Aperture-Priority AE Mode is automatically set.



Telephoto



Wide angle

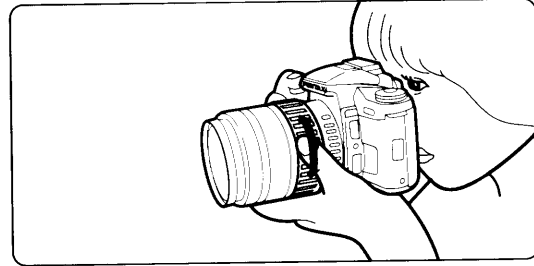

Turning the zoom ring to the right makes the subject appear larger (telephoto) and turning it to the left makes the subject appear smaller (wide angle).

- The Image Size Tracking Mode, Zoom Clip Mode, Auto Zoom Effect Mode and Power Zoom function do not operate with this camera even if an FA power zoom lens is attached.
- The smaller the number shown in the zoom scale window, the wider the angle. Conversely, the larger the number, the more magnified the image appears.

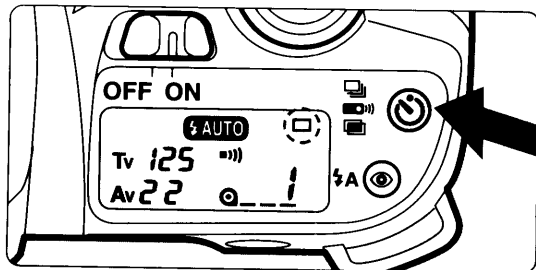

Depress the drive button until [□] appears on the LCD panel.

- One picture is taken each time the shutter release button is depressed.
- See page 37 for other available function.

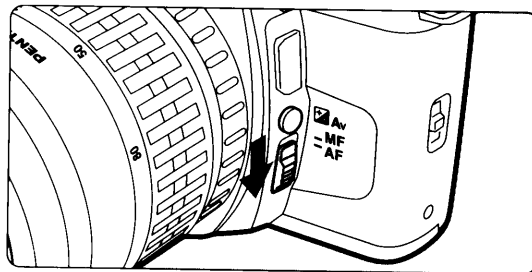

For autofocus operation, set the focus mode switch to [AF]. When you depress the shutter release button halfway down, the lens automatically focuses.

Set the focus mode switch to [AF].

- See page 64 for manual focusing.

Camera held horizontally

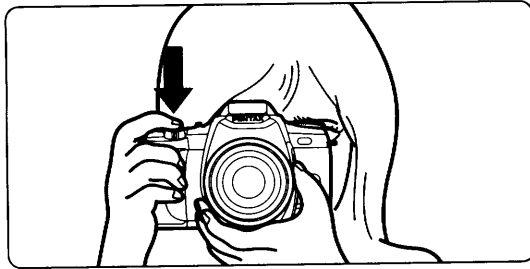

For best results, be sure to hold the camera correctly as shown in the illustrations.

Hold the camera firmly, with your left hand supporting the camera and lens as shown in the illustrations.

While taking a picture, hold your breath and gently depress the shutter release button. Sudden force on the shutter release button will cause camera shake, making the picture blurred.

Camera held vertically

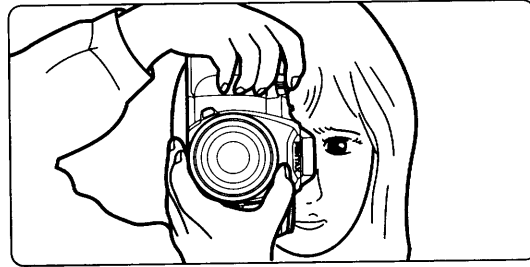

- To reduce camera shake, support your body or the camera on a solid object - a table, tree, or a wall for instance.
- When using an ultra-telephoto lens, a tripod that is heavier than the total weight of the camera and lens is recommended to avoid camera shake.
- Although there are individual differences among photographers, in general the shutter speed for a hand held camera is the inverse of the focal length. For example, 1/50 of second when the focal length is 50mm, and 1/100 of second when it is 100mm. A tripod should be used for shutter speeds slower than this.

TAKING A PICTURE



Confirm that the focus mode switch has been set to [AF].

1. Focus on the subject with the 3 point-AF frame [C] indicated in red in the photograph. When the shutter release button is depressed halfway down, the lens automatically focuses.
2. When the shutter release button is depressed halfway down, the shutter speed, aperture setting and selected picture mode are displayed in the viewfinder and the LCD panel.
3. When the subject is in focus, the focus indicator [●] lights up and an audible PCV beeping signal is emitted.

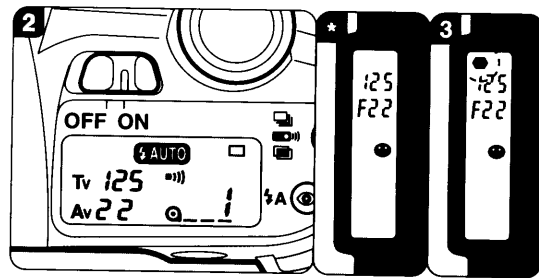

- As this camera incorporates the 3-point autofocus system, the subject will be focused properly even if the subject is slightly off the center of the AF frame.
- The audible PCV signal can be turned off. See details on page 63.
- During autofocus operation, the focusing ring should not be obstructed with your fingers, hands, or any other object.

The focus indicator [●] blinks when the camera is not able to obtain proper focus for one of the following reasons.

1. The subject is too close. Adjust the camera-to-subject distance.
2. The subject is difficult to autofocus. See "HARD-TO-AUTOFOCUS" subject on page 66.

4. **Take a picture. Gently depress the shutter release button.**
5. **The built-in flash pops up automatically when the use of flash is recommended.**

- The shutter cannot be released if the subject is out of focus.
- Depress the shutter release button halfway down. While [●] is on, the camera-to-subject distance is fixed (focus lock). To refocus on another subject, lift your finger off the shutter release button.
- If the subject is moving too fast, the shutter may not be released.
- The built-in flash starts charging automatically. When it is fully charged, [⚡] appears on the LCD panel.

Predictive Autofocus Mode

When the camera senses subject movement during the autofocus operation, the camera will automatically switch the focus mode to the predictive autofocus mode to measure the speed of a moving subject, and predict where it will be at the moment of shutter release to maintain sharp focus on the subject.



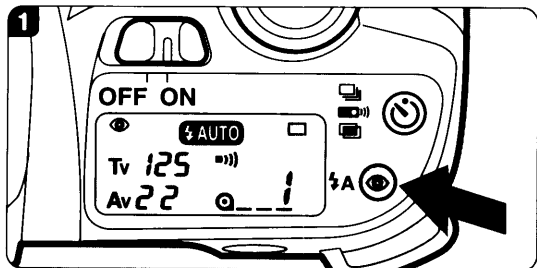

- The built-in flash does not retract automatically. To retract the flash, push it by the top until it clicks into the position.
- Note that the built-in flash pops up even when the subject is far away or beyond the maximum flash effective range. See page 35 for the maximum flash effective range.
- Note also that the built-in flash pops up even when the lens on your camera is not appropriate for shooting with a flash. For more details on COMPATIBILITY OF F AND FA LENSES WITH THE BUILT-IN FLASH, see page 69 for incompatible lenses.
- When the built-in flash is used, using a lens hood is NOT recommended as it may obstruct the path of the light coming from the flash, causing vignetting in the picture corners.
- The built-in flash does not pop-up automatically when the external flash is attached.

SELECTING THE VARIOUS FLASH MODES

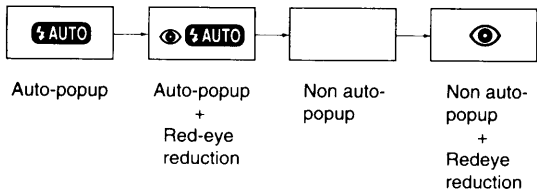

At each press of the flash mode button, the flash mode on the LCD panel switches as shown in the chart.



- The auto-popup flash mode can only be set when the Auto Picture Mode or one of 5 picture modes is set.
- The built-in flash pops up automatically when [] is displayed on the LCD panel. But it discharges only when required. (Automatic flash function)
- [] or [] can only be set when the Auto Picture Mode is set.
- The auto-popup function of the built-in flash does not work when the memory lock function is in use.
- The automatic flash function can also be used with the external flash.
- The built-in flash does not pop-up automatically when the external flash has been mounted. However, [] is displayed on the LCD panel either with the power off or the external flash is not yet fully charged.

AF illuminator

When the shutter release button halfway down where it is hard for autofocus to work, such as in a dark place, the built-in flash discharges continuously to provide illumination, making it easy for the autofocus to work.

- The effective range of AF illuminator is approx. 1m to 5m.
- The AF illuminator of the built-in flash does not work if you use the spotbeam of the external flash such as the AF500FTZ or AF330FTZ flash.
- The AF illuminator does not work either when the Action Program Mode has been selected with the focus mode switch set to the MF position or when the flash disable mode has been selected.
- The external flash discharges if the AF spotbeam works when the AF500FTZ is attached and the slave flash function is in use. You should therefore set the focus mode switch to the MF position before using the slave function.

Red-eye Reduction Flash Function

This camera includes a red-eye reduction flash function, which reduces the red-eye phenomenon utilizing preflash. In this mode, the preflash is discharged just before the shutter is released which reduces the diameter of the pupil of the eye. Then the main flash is discharged while the pupils are smaller, which in turn reduces the red-eye effect.

About Red-eye Phenomenon

Shooting portraits with flash in a dark environment often causes a subject's eyes to turn out reddish in the print. This phenomenon, commonly known as "Red-Eye", is caused by the reflection of the electronic flash in the retina of your subjects eye. It can be reduced by taking the photo in a brighter light condition or by shooting with a wider angle lens at a closer distance, or by employing the red-eye reduction flash feature. When using a Pentax dedicated flash unit off the camera, it may also help to position the flash as far away from the camera as possible.

ACTIVATE THE BUILT-IN FLASH MANUALLY

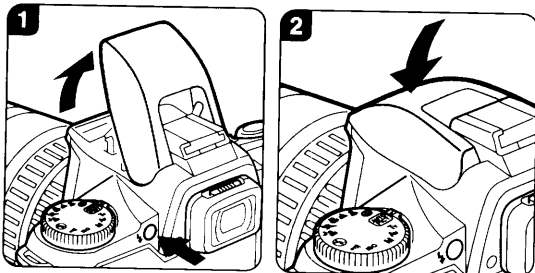

1. Push the flash pop-up button to activate the flash. Depress the shutter release button fully, and the flash unit discharges.
2. After using the flash, retract the built-in flash by pressing it down into the camera body.

* The built-in flash starts charging automatically. When it is fully charged, [⚡] appears on the LCD panel. When the shutter release button is depressed halfway down, [AUTO] disappears from the LCD panel, and the flash always discharges even if the subject is not required flash light.

- The built-in flash does not pop up even if the flash pop-up button is pushed when the mode dial set to [⊕].

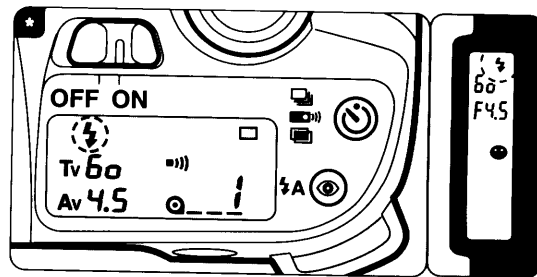

- The shutter cannot be released until the flash is fully charged.
- If the built in flash is used continuously, the battery may become warm, but it does not mean the battery is faulty; it is one of the battery's characteristics.
- When the built-in flash is used, using a lens hood is NOT recommended as it may obstruct the path of the light coming from the flash, causing vignetting in the picture corners.
- With the built-in flash popped-up, an external flash cannot be attached to the hot shoe. If you would like to use an external flash together with the built-in flash, see the flash connections on page 74.

Flash effective range for the Auto Picture Mode and Picture Mode with ISO 100 (400) film used

Maximum Lens Aperture	Effective Range
f/1.4	approx. 0.8 - 3.9m (0.8 - 5.6m) 2.6 - 12.8ft (2.6 - 18.4ft)
f/2	approx. 0.8 - 3.3m (0.8 - 4.8m) 2.6 - 10.8ft (2.6 - 15.7ft)
f/3.5, f/4.7	approx. 0.7 - 2.4m (0.7 - 4.0m) 2.3 - 7.9ft (2.3 - 13.1ft)
f/5.6	approx. 0.7 - 2.0m (0.7 - 4.0m) 2.3 - 6.6ft (2.3 - 13.1ft)

The effective range of the flash depends on the maximum aperture of the lens is in use. A lens with a maximum aperture of f/1.4 is marked as 1:1.4 on its barrel.

- This effective range table is only applicable when the Auto Picture Mode or Picture Mode is set. When any other exposure mode is used, see page 68.

- The minimum effective range is always 0.7m (2.6ft) even if a lens with a maximum aperture f/2.8 or smaller is in use. When a subject is shot at a distance closer than 0.7m (2.6ft), the correct exposure cannot be obtained, and you will see vignetting in the picture corners.

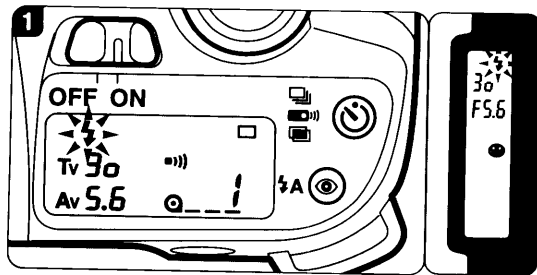

The flash-recommended indicator [] on the LCD panel blinks and the indicator in the viewfinder turns to orange color when you attempt to photograph a subject in low light to warn you of possible camera shake.

- In the Shutter-Priority AE Mode and Metered-Manual Mode, the flash-recommended indicator blinks only when attempting to photograph a subject in a backlit situation.
- The indicator in the viewfinder turns to green when the flash is fully charged.

Inappropriate lens warning when the built-in flash is used

When using an inappropriate F- or FA- lens, [] will blink in the viewfinder and on the LCD panel when the shutter release button is depressed halfway down. For more details on COMPATIBILITY OF F AND FA LENSES WITH THE BUILT-IN FLASH, see page 69.

- Taking a picture while this warning is displayed may cause vignetting in the picture corners or semi-circular vignetting at the bottom of the picture.
- When lenses other than an F or FA are used, this warning will not appear.

This camera has a total of six drive modes as shown.

Types of Drive Modes

Single-Frame Mode

[] : One picture is taken each time the shutter release button is depressed.

Consecutive-Frame Mode

[] : Pictures can be taken consecutively while holding down the shutter release button. See page 38

Self-timer Mode

[] : A picture will be taken with a 12-second-delay. See page 38.

3-second-delay release mode

[] 3s : The shutter will be released 3 seconds after the remote control's shutter release button is depressed. See page 40.

Instant Release Mode

[] : The shutter will be released instantly after the remote control's shutter release button is depressed. See page 42.

Multiple-Exposure Mode

[] : See page 43 for more details.

III. ADVANCED OPERATIONS

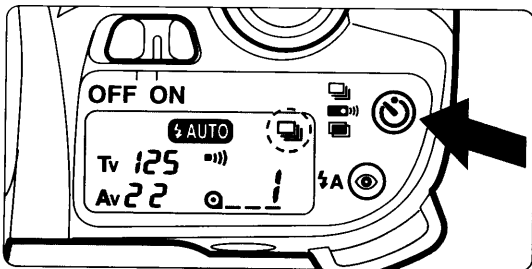

Consecutive-Frame Mode

Consecutive pictures can be taken by holding down the shutter release button.

How to set

Depress the drive mode button until [] appears on the LCD panel.

- The camera focuses on the subject frame by frame in this mode.
- The shutter cannot be released while the built-in flash is being charged.

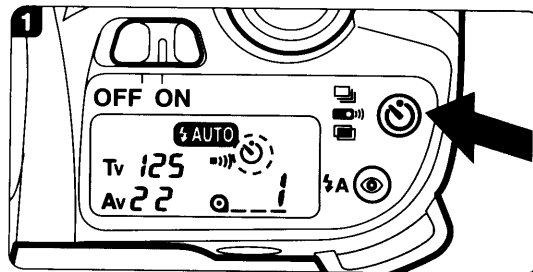

Self-timer Mode

The self-timer mode delays the shutter release, and is useful for taking group shots that include the photographer. The shutter will be released about 12 seconds after the shutter release is depressed.

How to set

1. Depress the drive mode button until [] appears on the LCD panel.

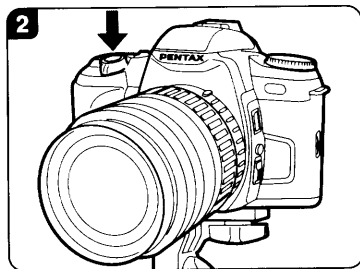

2. Focus on the subject first using the autofocus frame and by depressing the shutter release button halfway down. Then depress the shutter release button fully.

- * When the self-timer is in operation, the audible PCV signal is heard and the rate increases for the last two seconds.
- The shutter will be released about 12 seconds later.

How to cancel

To cancel the self-timer operation after it has been activated, depress the drive mode button again.

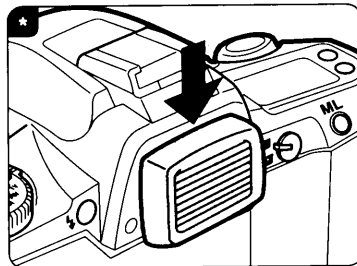
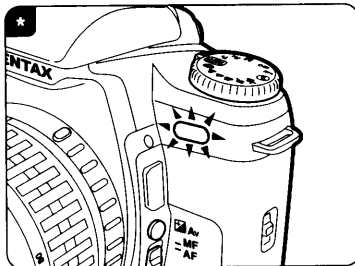

* Underexposure may occur if light enters the viewfinder during self-timer operation. If you intend to move away from the viewfinder, attach the supplied finder cap as shown in the illustration.

- When using accessories such as the finder cap, remove the Eyecup FK. The Eyecup FK comes from the factory fitted to the camera's viewfinder accessory grooves.

REMOTE CONTROL SHOOTING (OPTIONAL)

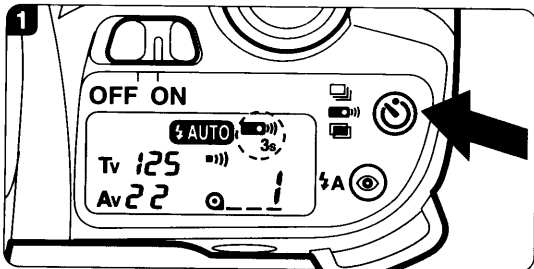

1 If you have purchased the optional wireless remote control, read this section.

3-second-delay release mode

The shutter will be released 3 seconds after the remote control's shutter release button is depressed.

1. Depress the drive button until [ 3s] appears on the LCD panel.

- Adjust the focus by depressing the shutter release button halfway down or manually and then depress the remote control's release button.

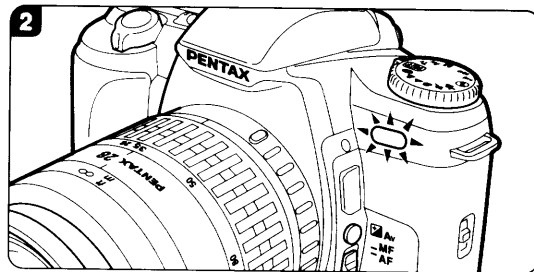

2. The self-timer lamp starts blinking slowly.

Battery life on the Remote Control

About 30,000 commands can be issued using the Remote Control. If the battery is exhausted, please have it replaced at your local Pentax Service center (there is a charge for this service).

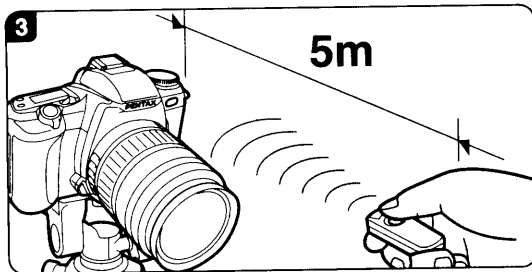

3. Aim the remote control transmitter towards the remote control receiver on the camera, and then depress the shutter release button on the remote control.

- The operating distance of the wireless remote control is 5m from in front of the camera.

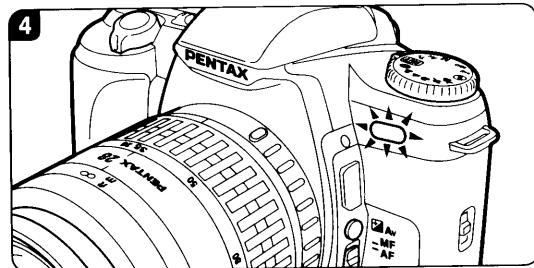

4. The self-timer lamp blinks rapidly for 3 seconds and then the shutter is released.

- When the self-timer lamp blinks rapidly, the audible PCV signal is heard.
- When the picture is taken, the self-timer lamp lights for approx. 2 seconds.
- The PVC signal can be canceled.
- The remote control may not work in a backlight situation.
- To cancel the self-timer at any time after it's been activated, set the main switch to the OFF position or depress the drive button to set any other mode.

REMOTE CONTROL SHOOTING (OPTIONAL)

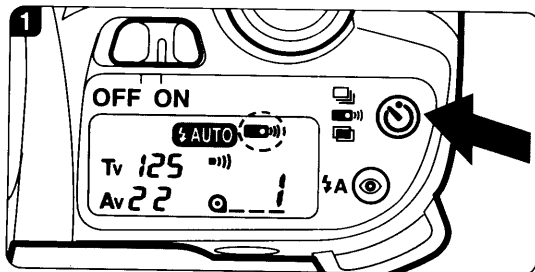

If you have purchased the optional wireless remote control, read this section.

Instant Release Mode

The shutter will be released instantly after the remote control's shutter release button is depressed.

1. Depress the drive button until [] appears on the LCD panel.

- Adjust the focus by depressing the shutter release button halfway down or manually and then depress the remote control's release button.

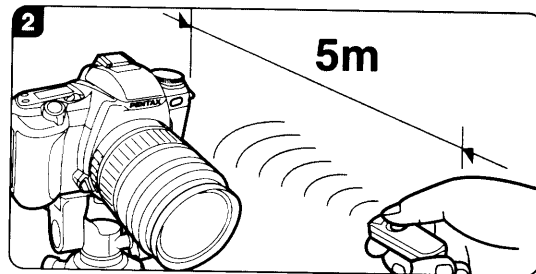

2. Aim the remote control transmitter towards the remote control receiver on the camera, and then depress the shutter release button on the remote control.

- The operating distance of the wireless remote control is 5m from in front of the camera.
- When the picture is taken, the self-timer lamp lights for approx. 2 seconds.

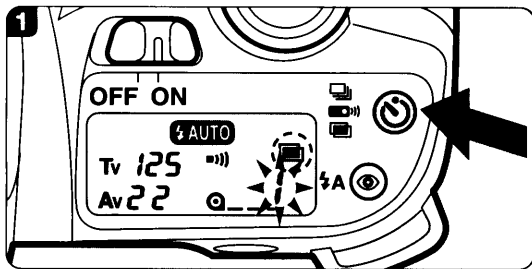

Multiple Exposure Mode

Procedure

1. Depress the drive button until [] appears on the LCD panel. The frame counter on the LCD panel blinks.
2. Depress the shutter release button to shoot an initial exposure. The film will not advance. The frame counter and [] on the LCD panel blink.
3. Recompose the frame and depress the shutter release button to shoot the second shot. The exposure counter on the LCD panel stops blinking. The single-frame shooting will be restored.

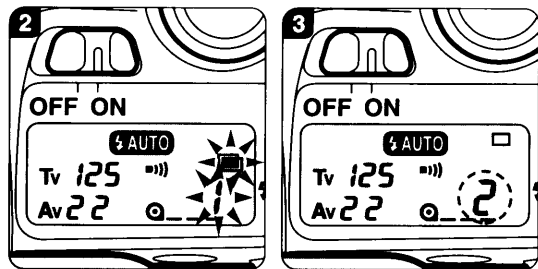

- To exposure the third shot or more, depress the drive button until [] appears and repeat step 3.
- In this mode, the data will not be imprinted.

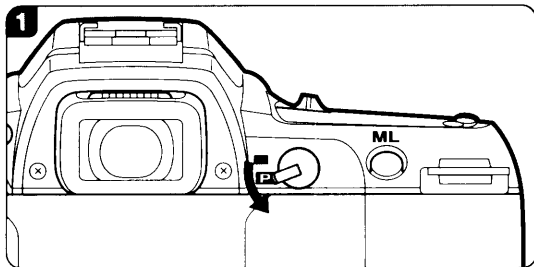

You can switch between the panorama format and standard format picture taking mode in the middle of the roll by moving the panorama lever. The panorama format picture allows horizontally positioned dynamic pictures to be taken (the panorama format is approximately 13x36mm on the film).

1. Turn the panorama lever to [P] to select the panorama format mode.
2. Compose the scene within the panorama format frame in the viewfinder.

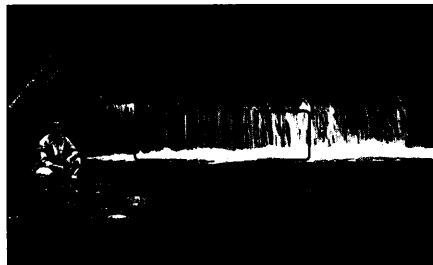

- When the panorama lever is switched to panorama, the viewfinder switches to the horizontal panorama format frame.
- Ensure that the panorama lever is turned fully to the position you selected.
- What appears on the extreme edges of the panorama frame may be cut off in the development process. Compose your picture with a margin of safety.

NOTES ON THE DEVELOPMENT OF PANORAMA FORMAT PICTURES

With panorama format pictures, only the middle area of the frame is exposed. The number of exposures available in the panorama format is equivalent to that of the standard photo size.



- When developing the film, if you have taken only panorama format pictures on the entire roll of film, tell the clerk at the processing lab to develop the film with only the panorama format. If there are both panorama and standard format pictures on the film, ask the clerk to develop the film with both standard and panorama format.
- The development of panorama format pictures is a more time-consuming and expensive process than that of standard pictures. Please consult the processing lab for more details.
- Panorama format processing facilities differ depending on the area and requirement. Your local film processor or camera dealers will advise you on all options available to you.
- When the panorama format pictures are printed with a standard size format, the black cropped areas will appear at the top and bottom of the picture.

USING THE PICTURE MODE

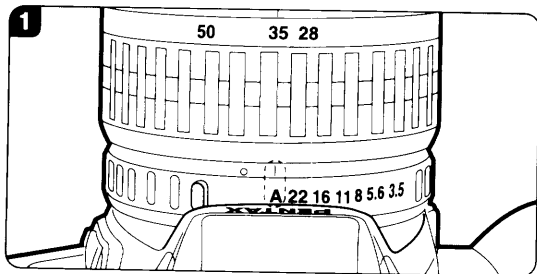

The camera incorporates the Auto Picture Mode function. In this mode, the camera automatically selects the one of 5 picture modes according to the requirement of the scene. You can also select your desired Picture Mode manually. The picture mode has a total of 6 modes as follows. See details for each mode on page 47 - 52.

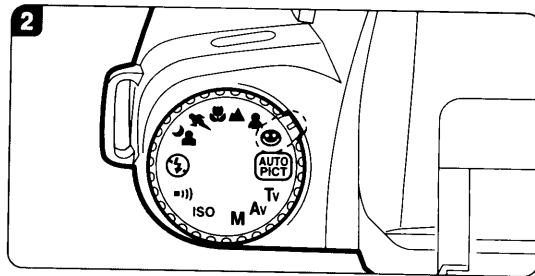

How to set

1. Set the lens aperture ring to [A].
2. Set the mode dial to the desired exposure mode.

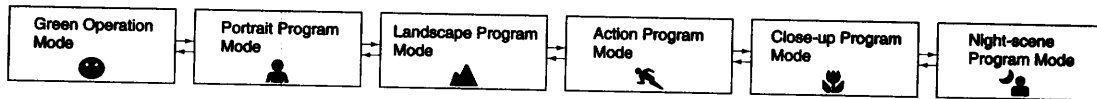

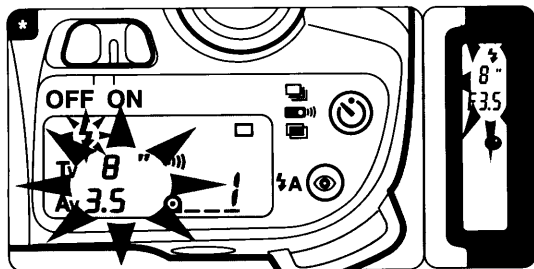

* Exposure Warning

If the subject is too bright or too dark, the shutter speed and aperture setting in the viewfinder will blink. If the subject is too bright, select a darker subject. Use a flash if the subject is too dark.

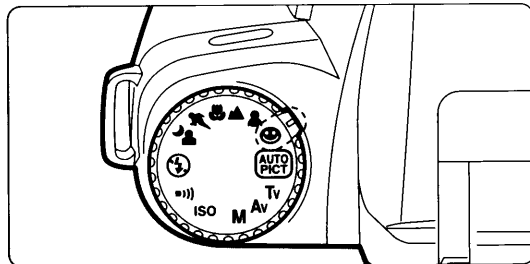
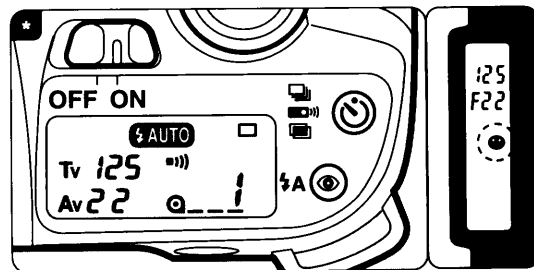

Green Operation Mode

For easy picture taking, use the Green Operation Mode. You simply depress the shutter release button. The camera selects the best combination of aperture and shutter speed setting.

How to set:

Set the mode dial to [].

* When the shutter release button is depressed halfway, [] will be displayed in the viewfinder. The shutter speed and aperture setting are also displayed in the viewfinder and on the LCD panel.

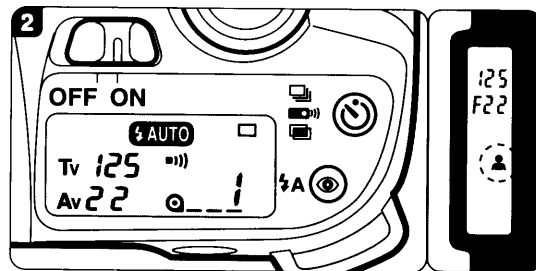
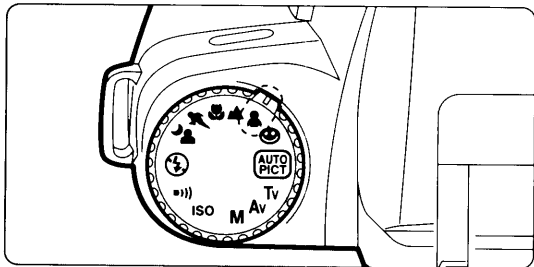
Portrait Program Mode 

This mode is suitable for taking portrait photography.

How to set

Set the mode dial to [].

* When the shutter release button is depressed halfway down, [] is displayed in the viewfinder. The shutter speed and aperture setting are also displayed in the viewfinder and on the LCD panel.

In this mode, the telephoto lens produces a portrait in crisp focus against the out-of-focus background, while the wide angle lens enables you to shoot group photography or snapshots in sharp and clear focus with the extended depth-of-field.

Landscape Program Mode ▲

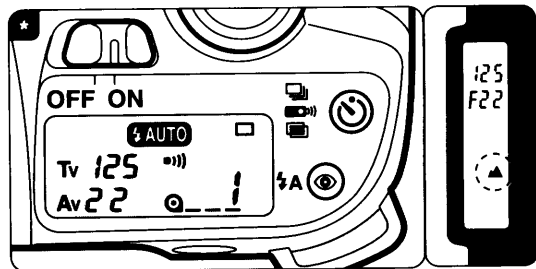
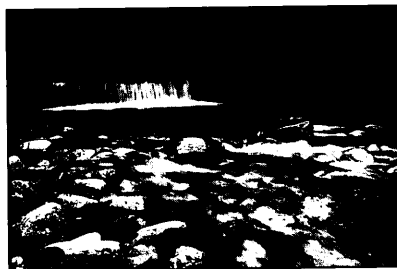
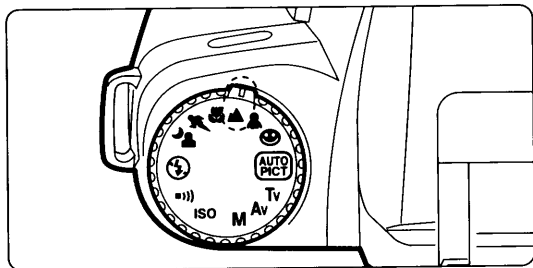

This mode is ideal for landscape photography and scenic snapshots.

How to set
Set the mode dial to [▲].

* When the shutter release button is depressed halfway down, [▲] is displayed in the viewfinder. The shutter speed and aperture setting are also displayed in the viewfinder and on the LCD panel.

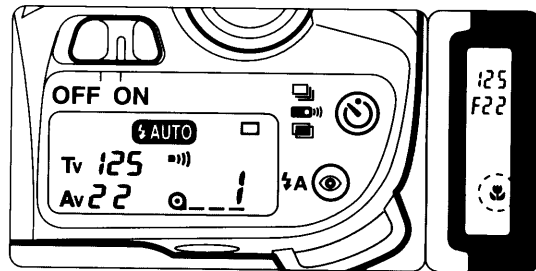
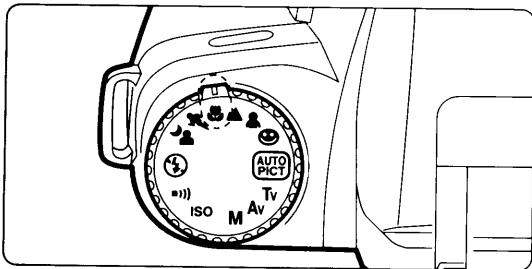
Close-up Program Mode 

This mode is useful for close-up photography. This mode favors smaller apertures to maximize the depth of field, ensuring sharp focus of a close-up subject.

How to set

Set the mode dial to [].

* When the shutter release button is depressed halfway down, [] is displayed in the viewfinder. The shutter speed and aperture setting are also displayed in the viewfinder and on the LCD panel.

Action Program Mode

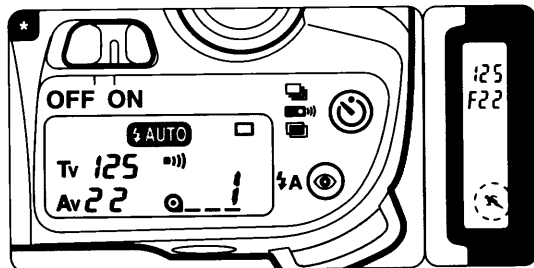
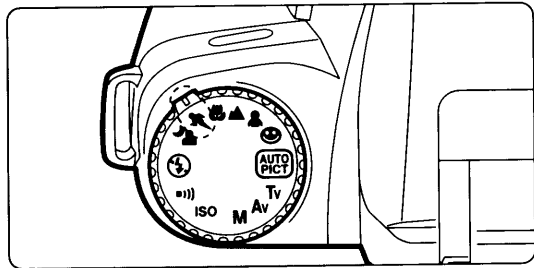

This mode selects a faster shutter speed to capture a moving subject.

How to set

Set the mode dial to .

* When the shutter release button is depressed halfway down,  is displayed in the viewfinder. The shutter speed and aperture setting are also displayed in the viewfinder and on the LCD panel.

This mode freezes the action and prevent blurred images. This mode is especially convenient for active photography. It is also suitable for portraits with blurred background.

Night-scene Program Mode

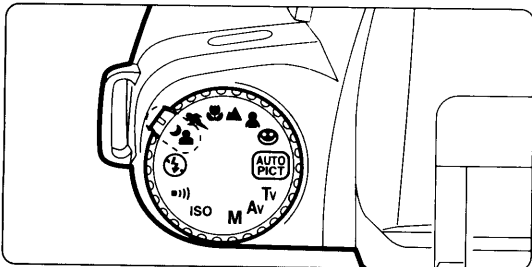

This mode is useful when taking a portrait photograph with a night scene in the background.

How to set

Set the mode dial to [].

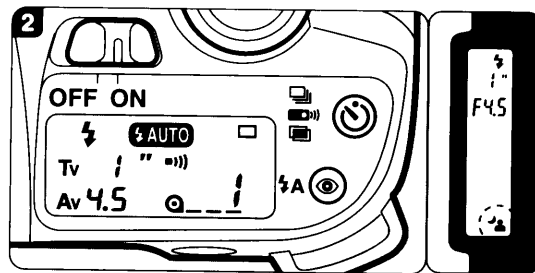



* When the shutter release button is depressed halfway down, [] is displayed in the viewfinder. The shutter speed and aperture setting are also displayed in the viewfinder and on the LCD panel.

It is possible to photograph subjects and background in a balanced way by using the flash to properly expose the foreground subject and a slow-speed to expose the low light background. The shutter speed automatically changes in the range of 1/100 to 1 second.

- Use of a tripod is recommended.
- The Green Operation Mode is automatically set when the built-in flash is not in use.

SELECTING AN EXPOSURE MODE

The exposure mode varies on the selection of the camera's mode dial and lens aperture ring setting as shown on the table below.

	Mode dial	AUTO PICT, 		TV	AV	M
Lens aperture	Lens aperture set to A position	Auto Picture Mode	Picture Mode	Shutter-Priority AE	Aperture-Priority AE	Metered-Manual
	Lens aperture set to other than A	Aperture-Priority AE	Aperture-Priority AE	Aperture-Priority AE	Aperture-Priority AE	Metered-Manual



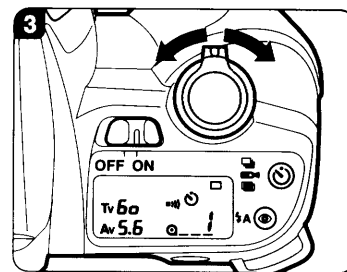
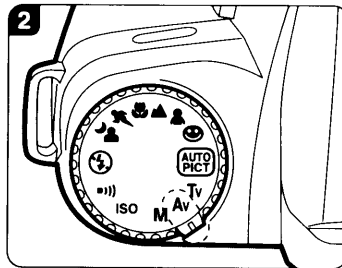
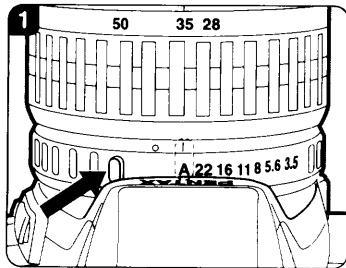

Using the Aperture-Priority AE Mode

Purpose





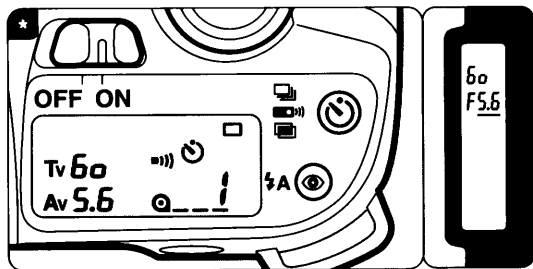

When the desired aperture is selected, an appropriate shutter speed is automatically set by the camera for a proper exposure. This mode is ideal for shooting landscapes with increased depth of field, or a portrait against a blurred background.

How to set

1. Set the lens aperture ring to [A].
2. Set the mode dial to [AV].
3. Select the desired aperture by moving the select switch.



* When the shutter release button is depressed halfway down, the shutter speed and aperture value will be displayed in the viewfinder and on the LCD panel. The bar underneath the aperture value indicates that you can change the aperture setting.

- The Aperture-Priority AE Mode can also set when the lens aperture rung is set the desired f-stop other than [A]. Set the mode dial to either [AUTO PICT], [], [], [], [], [] or [].
- The approximate aperture indication appears in the viewfinder. It may not be the same indication as you select the lens aperture.
- When lenses other than an F or FA series are used, no aperture indication will appear

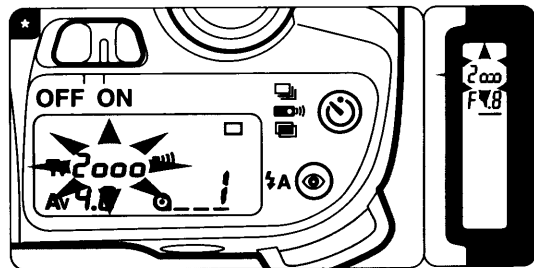

* Exposure Warning

If the subject is too bright or too dark, the selected shutter speed will blink in the viewfinder and on the LCD panel as a warning as shown. When the subject is too bright, choose a smaller aperture, if available; when it is too dark, choose a larger aperture, if available. When the shutter speed indication stops blinking, you can take the picture. If both shutter and aperture blink, it means that the exposure is out of metering range, unable to obtain a correct exposure even if the aperture is adjusted. Select a darker subject if it is too bright, or use a flash if it is too dark.

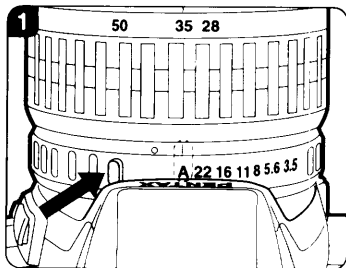

Using the Shutter-Priority AE Mode

Purpose

When the desired shutter speed is selected, the appropriate aperture is automatically set by the camera for a proper exposure according to the brightness of the subject. This mode is suitable for freezing the action with a fast shutter speed or capturing a flowing dynamic image with a slow shutter speed.

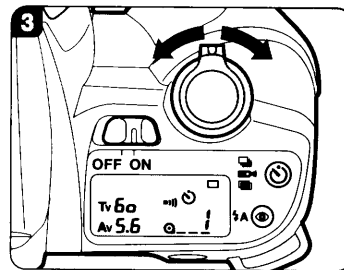
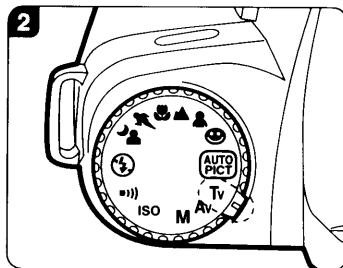

How to set

1. Set the lens aperture ring to [A].
2. Set the mode dial to [Tv].
3. Select the desired shutter speed by moving the select switch.

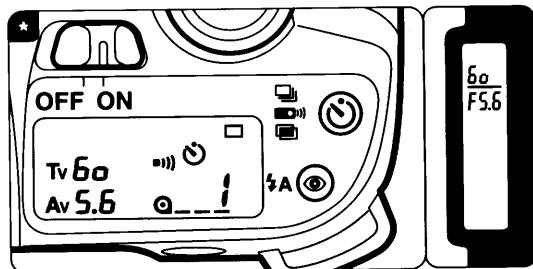

* When the shutter release button is depressed halfway down, the shutter speed and aperture value will be displayed in the viewfinder and on the LCD panel. The bar underneath the shutter speed indicates that you can change the shutter speed.

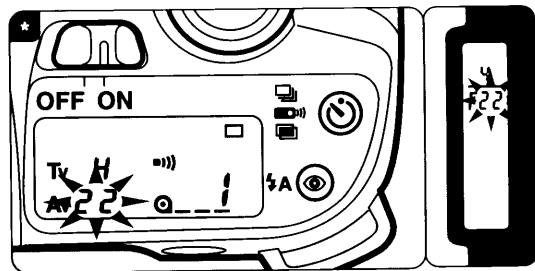

* Exposure Warning

If the subject is too bright or too dark, the shutter speed and aperture setting in the viewfinder blink. When the subject is too bright, choose a faster shutter speed. If it is too dark, choose a slower shutter speed. When the shutter speed indication stops blinking, you can take the picture. If both selected shutter speed and aperture blink, it means that the exposure is out of metering range, unable to obtain a correct exposure even if the shutter speed is adjusted. Select a darker subject if the subject is too bright. Use a flash if it is too dark.

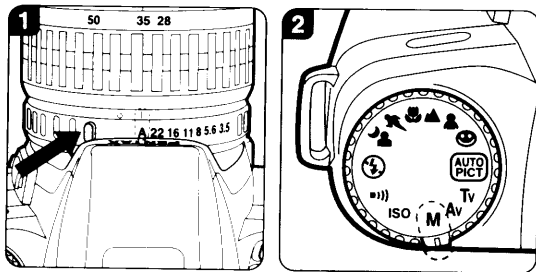

Using the Metered Manual Mode

Purpose

The manual exposure mode is a convenient exposure mode for taking pictures using the same shutter speed and aperture setting combination, or taking creatively under- or over-exposed photographs.

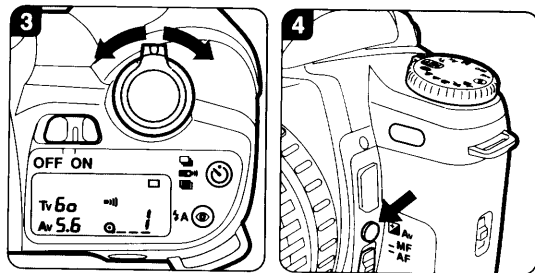

How to set

1. Set the lens aperture ring to [A].
2. Set the mode dial to [M].
3. Move the select switch to change the shutter speed.
4. Move the select switch while holding the exposure compensation button to change the aperture.

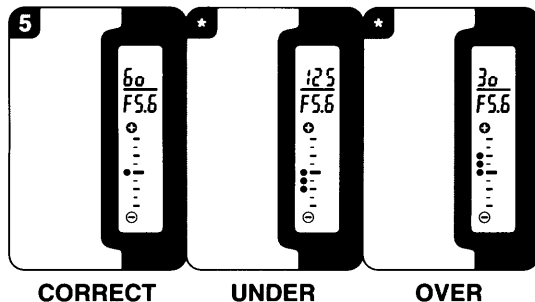

5. The dot displayed in the center of the bar graph indicates the correct exposure.

* When the dots are displayed to the [+] side on the bar graph, it indicates overexposure and when the dots are displayed to the [-] side, it indicates underexposure.

- Moving one dot on the bar graph indicates 0.5 step (0.5EV).
- When under or over exposure is set beyond + 2 or - 2 steps (3EV), [+] or [-] indicator will blink.

- When the shutter release button is depressed halfway down, the shutter speed and aperture value will be displayed in the viewfinder and on the LCD panel. The bar underneath the aperture value indicates that you can change the aperture setting.
- When lenses other than an F or FA lens is used, no approximate aperture indication will appear in the viewfinder.
- The memory lock does not operate in the Metered Manual Mode.
- The indicator in the viewfinder turns to orange when the shutter speed changes to a slower shutter speed which causes camera shake.

* Exposure Warning

If the subject is too bright or too dark, both shutter speed and aperture setting will blink in the viewfinder as a warning as shown. It means that the exposure is out of metering range, unable to obtain a correct exposure even if the aperture is adjusted. Select a darker subject or use a flash if it is too dark.

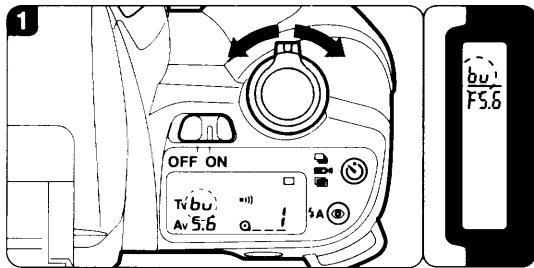

Bulb Exposure Mode

Purpose

This mode is useful for the long exposures required for shooting night scenes and fireworks. The shutter remains open as long as the shutter release button is held down.

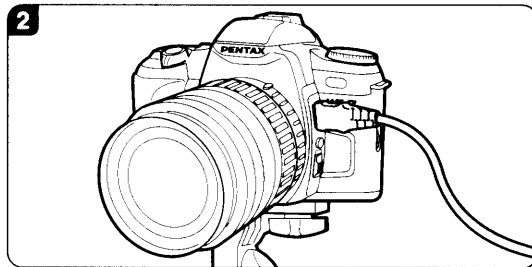

How to set

1. With the Metered Manual Mode set, move the select lever to change the shutter speed until [Bulb] appears in the viewfinder and on the LCD panel.
2. When using this mode, use a steady tripod to prevent camera shake and attach the optional "Cable Switch F" after removing the Release Socket Cap F.

- The shutter remains open as long as the shutter release button held down.
- Up to approx. 8 hours of time exposure are possible with a new lithium battery at room temperatures.
- The indicator in the viewfinder turns to orange.

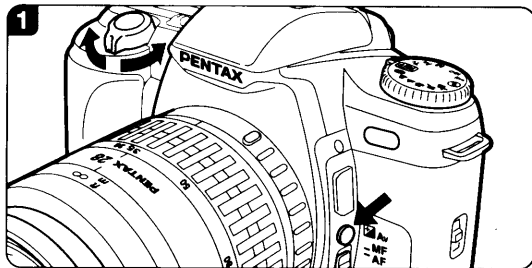

Purpose

The exposure compensation allows you to deliberately overexposure (brighten) or underexposure (darken) a subject, or compensate for difficult lighting conditions which may fool the camera's built-in exposure meter.

How to set

1. While holding down the exposure compensation button, move the select switch to the desired compensation value.
2. The bar graph which indicates the compensation value appears in the viewfinder and [] is displayed on the LCD panel.

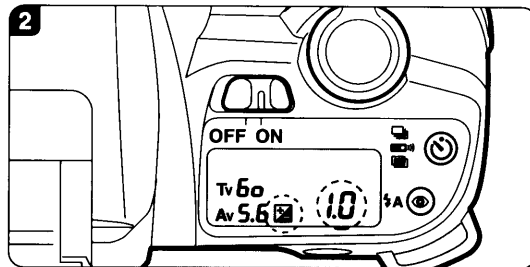

- When the dot is displayed to the [+] side, it indicates overexposure and when the dot is displayed to the [-] side, it indicates underexposure.
- Exposure compensation does not work in the Auto Picture Mode, Metered Manual Mode and Bulb Exposure Mode.
- The exposure compensation range is -3EV to +3EV in 0.5EV stops.

How to cancel

Set the compensation value to [0]. The exposure compensation cannot be canceled even if the power is turned OFF or any other exposure mode is set.

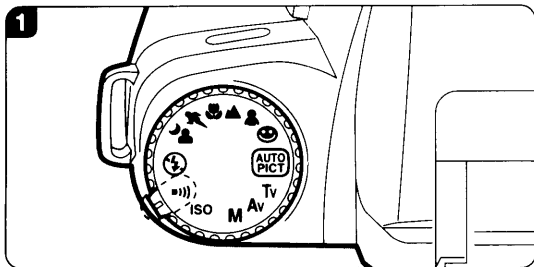

The audible PCV signal can be turned off.

How to cancel

1. Set the mode dial to [M].

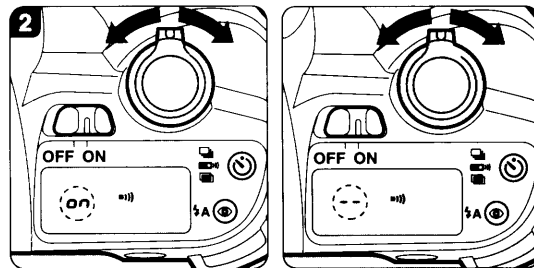

2. Move the select switch to display [an] on the LCD panel.

- You can change the audible PCV signal on or off when the self-timer, remote control, memory lock function is in use or when the focus is in-focus.
- The shutter cannot be released when the mode dial is set to [M].

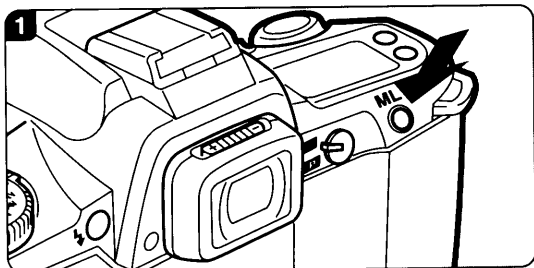

Purpose

The memory lock function enables an exposure level lock function to get a correct exposure from a neutral mid-tone area of a high-contrast scene.

To set the Memory Lock:

1. **Position the area to be measured in the viewfinder metering area and depress the memory lock button [ML].**
2. **[*] is displayed in the viewfinder and audible PCV signal can be heard. The measured exposure level is memorized for 20 seconds.**
3. **Recompose the image in the viewfinder and take the picture.**

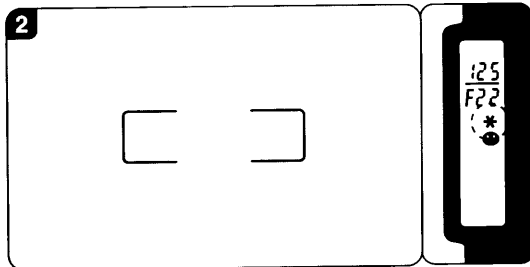

- If the shutter release button is depressed halfway down while the memory lock timer is operating, the memorized meter reading will remain even if the memory lock button is released.
- When the memory lock button is depressed, the audible PCV signal is heard. This PCV signal can be turned off. See page 62.
- The auto-popup built-in flash function does not work while the memory lock is used.
- The memory lock function does not operate in the Auto Picture Mode.

MANUAL FOCUSING

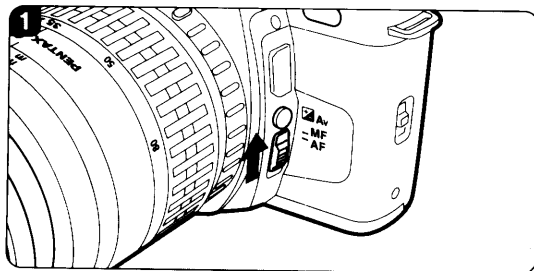

Using a manual-focus lens

When mounting a non-autofocus lens with a maximum aperture of $f/5.6$ or larger ($f/1.2$ to $f/5.6$), you can use the manual focus mode to focus the lens with the aid of the in-focus indicator [●] in the viewfinder.

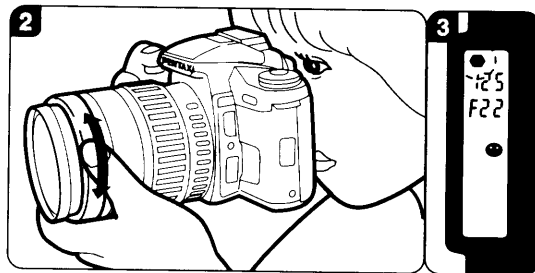

How to focus

1. Set the focus mode switch to [MF].
 2. While looking through the viewfinder, turn the focusing ring to the right or left while holding the shutter release button halfway down.
 3. When the subject comes into focus, the in-focus indicator [●] lights up in the viewfinder. Depress the shutter release button fully to take the photograph.
- When the subject comes into focus, an audible PCV signal is heard. The audible PCV signal can be canceled. See page 62.

When the autofocus mode or the in-focus indicator is unsuitable for focusing

When the autofocus function or the viewfinder's in-focus indicator [●] cannot be used for focus confirmation for the following reasons, focus on the subject in the manual focus mode with the aid of the matte field in the viewfinder as you would with a non-AF SLR camera.

- a) The in-focus indicator [●] blinks because the subject is difficult to autofocus.
- b) The maximum aperture of the lens in use is smaller than f/5.6.
- c) A bellows 100mm f/4, Shift 28mm f/3.5 (shift), or Reflex lens are in use.
- d) An old type screw-mount lens fitted with an optional "Mount Adapter K".

Focus on the subject with the aid of the matte field

1. **Set the focus mode switch to [MF].**
2. **While looking through the viewfinder, turn the focusing ring to the right or left until the image in the viewfinder is clearest.**

Using the snap-in focus function

When the subject comes to the point where the lens was prefocused, the shutter is automatically released.

How to use

1. **Use a non-autofocus lens.**
2. **Set the focus mode switch to [AF].**
3. **Focus at the point where you wish to capture the subject.**
4. **Using the optional "Cable Switch F", keep the trigger release button depressed so that the autofocus and metering systems stay active.**
5. **The camera releases the shutter automatically when the subject comes into focus at the point selected.**

HARD-TO-AUTOFOCUS SUBJECTS

The autofocus system is highly precise, but not perfect. Depending on the brightness, contrast, shape, and size of your subject, the autofocus system may not operate. In such a case, set the focus mode switch to [MF] and use the manual focus mode to focus the lens on the subject with the aid of the matte field in the viewfinder (see page 65).

Subjects which may fool the autofocus system include:

- a) Extremely low-contrast subjects such as a white wall in the autofocus frame [C].
- b) Subjects which don't reflect much light in the autofocus frame [C].
- c) Subjects which are moving too fast.
- d) Multiple subjects in the foreground and background of the autofocus frame [C].
- e) Subjects positioned against reflected light or strong backlight or with extremely bright backgrounds.

Using a Polarizing Filter

When using an ordinary polarizing filter; the half mirror incorporated into the autofocus system reduces the effectiveness of the autofocus function when used in combination with an ordinary polarizing filter. Use a CIRCULAR POLARIZING FILTER for proper autofocus operation.

Notes on accessories

The following conditions do not allow autofocus or manual focusing with the in-focus indicator in the viewfinder. Use the manual focus mode to focus on the subject with the aid of the matte field surrounding the autofocus frame.



- a) When using special effect filters or "Magic Image Attachment" or "Stereo Adapter".
- b) When using Extension Tubes or an Auto Bellows for close-up photography.

Note on the SMC Pentax F SOFT 85mm f/2.8 lens

When shooting at a distance closer than approx. 1.5m (4.9ft), set the lens to a manual f-stop setting between f/2.8 and f/4.5. A smaller aperture (f/5.6 to f/32) may cause the autofocus system and the viewfinder's in-focus indicator to malfunction. To remedy this problem, temporarily set the lens to f/4.5. After focusing on the subject, lock focus, and set the lens to the required f-stop.

- The FA Soft 85mm f/2.8 lens is not required above procedures.

When using the Auto Picture Mode or Picture Mode.

- The camera automatically chooses an optimum combination of shutter speed and aperture according to the subject brightness, allowing you to take a flash photograph with ease.
- The shutter speed automatically changes to approximately 1/100 sec. or to a slower speed which does not cause camera shake. The slowest shutter speed depends on the focal length of the lens fitted to the camera. When a Pentax non-AF lens is used or the Action Program Mode [] is used, the camera uses the shutter speed of 1/100 second. Note that the slowest shutter speed in the Night-scene Program Mode [] is 1 second.

When using the Shutter-Priority AE Mode

- When taking a fast moving subject, you can increase a subject's blur effect.
- Shutter speeds slower than 1/100 of second can be set.
- In this mode, the aperture automatically changes according to the ambient brightness, making flash photography easy.

When using the Aperture-Priority AE Mode

- In this mode, the shutter speed automatically changes with the ambient brightness, making flash photography easy. The shutter speed changes in the range of 1/100 sec. to a slower shutter speed which does not cause camera shake. The slowest shutter speed depends on the focal length of the lens in use. The shutter speed of 1/100 sec. is automatically set when a Pentax non-autofocus lens is in use. When a Pentax non-AF lens is used or the Action Program Mode [] is used, the camera uses the shutter speed of 1/100 second.

Metered Manual Mode

- When using the built-in flash in the Metered Manual Mode, any combination of aperture and shutter speed slower than 1/100 can be set. In this mode, the exposure of the background can be controlled by the manual exposure while the flash properly exposes the foreground subject.

Calculating the flash effective distance according to the camera-to-subject distance.

Maximum flash distance = Guide Number \div Selected aperture

Minimum flash distance = Maximum flash distance \div 5*

When the distance to the subject is less than 0.7m (2.3ft), the flash cannot be used. If the flash is used within that distance, it causes vignetting in the picture corners, light is distributed unevenly and the picture may be overexposed.

- The value 5 used in the formula above was obtained from the built-in flash.

The guide number (GN) depends upon the film speed used as shown below.

ISO25 \rightarrow GN5.5	ISO200 \rightarrow GN15.6
ISO50 \rightarrow GN7.8	ISO400 \rightarrow GN22
ISO100 \rightarrow GN11	

If an ISO100 film is used at an aperture of f/2.8, the flash effective distance is obtained as follows:

Guide Number (11) \div f/2.8 = 3.9m

3.9 \div 5 = 0.8m

Thus, the flash effective distance is from approx. 0.8m to 3.9m.

Calculating the aperture according to the camera-to-subject distance

Aperture = Guide Number \div Camera-to-subject distance

If the calculated aperture value is different than an indicated f-stop on the aperture ring, for instance f/3, choose the next smallest aperture ring number (f2.8 in this case).

COMPATIBILITY OF F AND FA LENSES WITH THE BUILT-IN FLASH

[O = compatible x = incompatible because of vignetting]

Lens Name	Compatibility
F Fish-Eye Zoom 17-28mm f/3.5-4.5	x
FA Zoom 20-35mm f/4	Δ *1
FA Zoom 28-70mm f/4	O
FA* Zoom 28-70mm f/2.8	x
FA Zoom 28-80mm f/3.5-5.6	Δ *2
FA Zoom 28-105mm f/4-5.6 (IF)	Δ *3
FA Zoom 28-200mm f/3.8-5.6	Δ *4
F or FA 35-80mm f/4-5.6	O
FA Zoom 70-200mm f/4-5.6	O
FA* Zoom 80-200mm f/2.8	Δ *5
FA Zoom 80-320mm f/4.5-5.6	O
F Zoom 80-200mm f/4.7-5.6	O
FA Zoom 100-300mm f/4.5-5.6	O
FA Zoom 100-300mm f/4.7-5.8	O
F or FA *Zoom250-600mm f/5.6	x
FA Soft 28mm f/2.8	O

Lens Name	Compatibility
FA Soft 85mm f/2.8	O
FA 20mm f/2.8	x
FA* 24mm f/2	x
FA 28mm f/2.8	O
FA 35mm f/2	O
FA 50mm f/1.4, f/1.7	O
FA 77mm f/1.8 Limited	O
FA* 85mm f/1.4	O
FA 135mm f/2.8	O
FA* 200mm f/2.8	O
FA* 300mm f/2.8	x
FA* 300mm f/4.5	O
FA* 400mm f/5.6	O
FA* 600mm f/4	x
FA MACRO 50mm f/2.8	O
FA MACRO 100mm f/2.8, f/3.5	O

*1 : Vignetting will occur at focal lengths between 20-28mm.

*2 : Vignetting will occur at focal lengths between 28-35mm when the camera-to-subject distance is closer than 3m. With the focal length set at 35mm, it will occur when the camera-to-subject distance is closer than 1m.

*3 : Vignetting will occur at focal lengths between 28-40mm.

*4 : Vignetting will occur at focal lengths between 28-70mm.

*5 : Vignetting will occur at focal lengths between 80-90mm.

SETTING THE FILM SPEED (ISO) MANUALLY

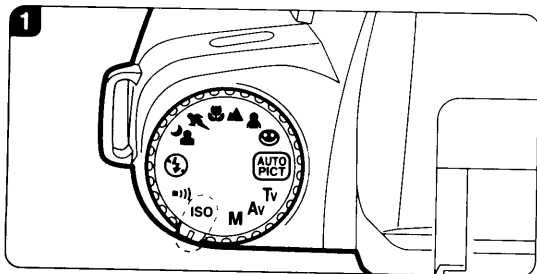

This camera automatically reads the film speed from the film's DX code. However, the film speed setting can be changed. If you use a non-DX coded film, set the film speed manually.

How to set

1. Set the mode dial to [ISO].
2. Move the select switch until the desired ISO is displayed on the LCD panel.
3. After the ISO is set, set the mode dial to any other position other than [ISO].

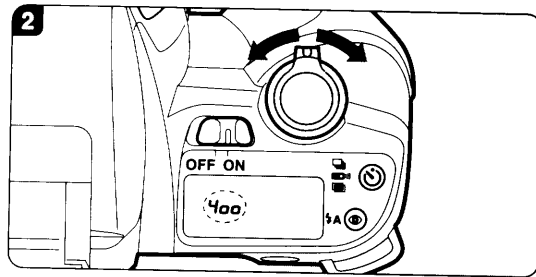

- To change the ISO, turn the select switch to the left for a smaller number (lower film speed or right for a larger number (higher film speed).
- The shutter cannot be released with the mode dial set at [ISO].
- [ISO] is displayed when the film speed is set manually.

ADJUSTING THE DATA (optional)

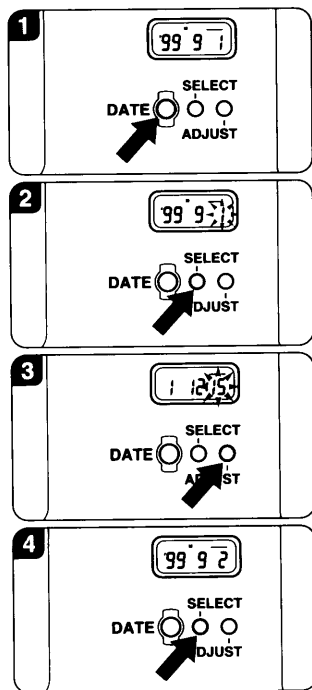

If you have purchased your camera as the DATE model version, or if you have purchased the Data Back separately, the following section applies.

Note:

Carefully press the button with the protrusion part of the camera's strap clamp.

Do not press the buttons with an object having a sharp tip.

Adjusting the year/month/day

1. Press the DATE button repeatedly until the date is displayed.
2. Press the SELECT button to make the year, month or day you want to change blink. The digits blink in the following order.

Year - Month - Day - Year

3. Change the date with the ADJUST button.

- The digit increases by one each time the ADJUST button is depressed. Holding the button for about 2 to 3 seconds will change the digits continuously.

4. Press the SELECT button to stop the digit from blinking, after you have changed the date. The adjusted date has been entered.

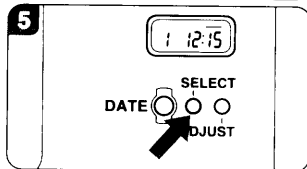
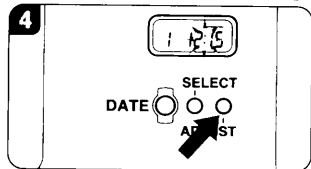
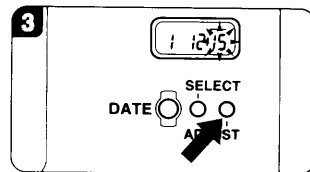
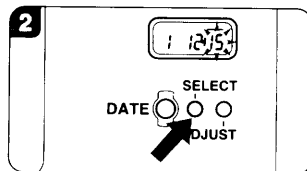
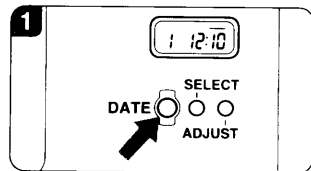

Adjusting the hour/minute

1. Press the DATE button repeatedly until the time is displayed.
2. Press the SELECT button to make the hour, minute or second (:) you want to change blink. The digits blink in the following order. Hour - Minutes - : - Hour
3. Change the data (hour or minute) with the ADJUST button.
4. To change the second (:), press the SELECT button until “ : ” will blink, and then press the ADJUST button in sync with a time signal to set the second to zero.
5. Press the SELECT button to stop the adjusted hour/minute from blinking.

Operational precautions

- The working temperature for data printing is 0°C - 50°C (32°F - 122°F).
- Use DX-coded films with ISO rating from 25 - 1600.
- If high-speed film with an ISO rating of 1000 or faster is used, the imprinted characters may blur.
- If film with ISO rating of 50 or slower is used, the printed characters may be dark or dim.
- If you release the shutter while the blinking data is being corrected, the data cannot be imprinted.

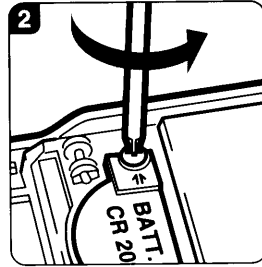
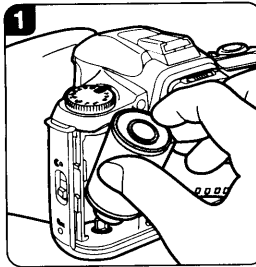

Replace the battery when the data information on a picture or the LCD panel becomes weak or invisible. The battery will last for approximately 3 years. The data back uses one 3V lithium battery, type CR2025.

1. Ensure that a film is not loaded, then open the back cover.
2. Loosen the battery cover fixing screw (located near the upper left side of the pressure plate) with a Phillips head screwdriver, and then remove the battery chamber cover.

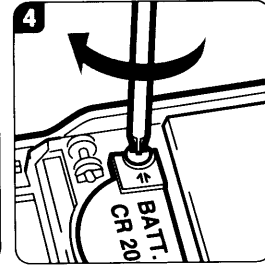
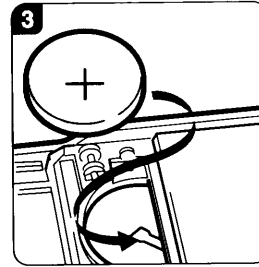

3. Replace the old battery with a new battery with the + side facing up.
4. Reinstall the battery chamber cover, and tighten the battery chamber fixing screw.

Note:

If the data indication does not appear on the LCD panel, it means that the battery has not been installed properly. After the battery has been replaced, adjust the data again.

USING PENTAX DEDICATED AUTO FLASH UNITS

If the built-in flash is not powerful enough, a Pentax dedicated auto flash should be used.

A Pentax dedicated TTL Auto Flash like the PENTAX AF FTZ or AF T series flash unit (ie: AF500FTZ, AF330FTZ, AF220T or AF280T) incorporate the TTL Flash Mode.

ADVANCED OPERATIONS

Using the TTL Auto Flash Mode

1. **Remove the hot shoe cover FK and attach a Pentax dedicated flash unit to the camera.**
2. **Turn the flash ON.**
3. **Set the flash mode to the TTL Auto Mode.**
4. **Confirm that the flash is fully charged.**
5. **Focus on the subject and release the shutter.**

- When the flash is fully charged, the ready lamp on the flash unit lights up. When the shutter release button is depressed halfway down, [] appears in the viewfinder indicating the flash is ready.

Note:

Read the operating manual of the flash unit for more details.

Using the built-in flash and the external flash simultaneously

An external flash cannot be used when the built-in flash is in its popped up position. When the built-in flash and the external flash are used simultaneously, use the following optional accessories.

- The AF400T flash cannot be used with the built-in flash simultaneously because the 4P sync cord B from the AF400T will interrupt the function of the built-in flash.

Hot Shoe Adapter FG

Off-Camera Shoe Adapter F

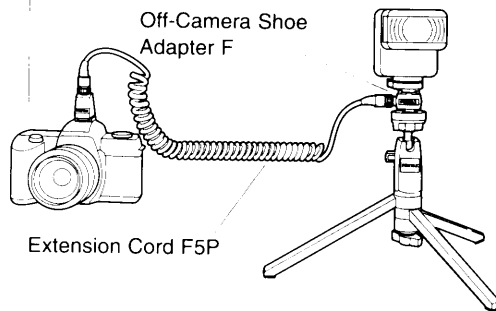

Extension Cord F5P

Red-eye reduction flash function

The red-eye reduction flash function with an external flash attached can also be used depending on what type of an external flash is attached, and it may have any restrictions for usage. See page 76 more details. The red-eye reduction flash function can be used only when the external flash is set to the TTL Auto Mode.

Trailing-Shutter-Curtain Flash function

When using the built-in flash and the external flash simultaneously, the trailing-shutter-curtain-flash function for the built-in flash also operates when the external flash is set to the trailing-shutter-curtain-flash function. Before shooting, confirm that both flash units are fully charged.

Contrast-Control-Sync Flash Photography

Using the AF330FTZ or AF500FTZ in combination with the built-in flash allows twin flash photography (contrast-control-synch flash photography). This is based on the difference between the amount of light discharged from two units.

- 1. Put the AF500FTZ or AF330FTZ in the Contrast-Control-Sync Flash Mode.**
- 2. Ensure that both flash units are fully charged and then shoot.**

- The ratio of the amount of flash light is 1 (built-in flash) : 2 (dedicated flash unit).
- Do not combine an accessory with a different number of contacts such as a "Hot Shoe Grip" as a malfunction may occur.
- In the Contrast-Control-Sync Flash Mode, the top flash sync speed is 1/60 of second.

Multi-burst flash with the Pentax dedicated flash

When discharging more than 2 Pentax dedicated flashes, make sure that they are of the same type, combine the type B with Type C or Type D with Type E. Refer to the overview of Flash Function on page 78. The built-in flash can be operated with any type of Pentax TTL dedicated flash unit except AF400T

Overview of Flash Function

CAMERA FUNCTION	TYPE A	TYPE B	TYPE C	TYPE D	TYPE E
Red-eye reduction flash function	○	○	x	○*1	x
After the flash is charged, the camera automatically switches to the flash-sync speed.	○	○	○	○	○
Automatic aperture setting in the Auto Picture Mode, Picture Mode or Shutter-Priority AE Mode	○	○	○	○*2	○*2
Flash confirmation in the viewfinder	○	○	○	x	x
TTL auto flash	○	○	○	○*3	x
Slow-speed sync in the Shutter-Priority AE Mode or Metered Manual Mode	○	○	○	○	○
AF spotbeam	x	○	○	x	x
Trailing-shutter-curtain sync flash *4	*5	○	○	x	x
Contrast-control-sync flash mode *4	x	○	○	x	x

TYPE A : Built-in flash

TYPE B : AF500FTZ (*6), AF330FTZ

TYPE C : AF400FTZ, AF240FT

TYPE D : AF400T, AF280T, AF220T, AF200T,
AF080C, AF140C, AF200SA, AF201A

TYPE E : AF200S, AF160, AF140

Notes:

- *1. When using the AF280T or AF400T with the flash confirmation OFF and TTL mode set, the red-eye reduction function operates.
- *2. When using a Type D flash (except AF200SA) in the MS (Manual Sync) or M (Manual) Mode or when using a Type E flash, set the camera's exposure mode to the Aperture-Priority AE Mode, Metered

Manual or Bulb. The Auto Picture Mode, Picture Mode and Aperture-Priority AE Modes cannot be used because the actual required aperture value may change.

- *3. Only the AF200SA flash does not operate.
- *4. Only the Metered Manual Mode can be used.
- *5. The shutter speed is 1/60 of second or slower.
- *6. Trailing-shutter-curtain sync flash combined with TYPE B or TYPE C flash.

Using other type of a flash

Use of non-Pentax flash units may damage the camera. For the best results, use a Pentax dedicated flash unit.

DAYLIGHT-SYNC SHOOTING



Without Daylight-Sync



With Daylight-Sync

Purpose

In daylight conditions, when a portrait picture is taken with a person's face cast in shadow, discharging the flash will eliminate the shadow.

1. Depress the red-eye reduction flash button to delete [4AUTO] from the LCD panel.
2. Confirm either the built-in or external flash is fully charged.
3. Take a picture.

- If the background is too bright, it may be overexposed.
- When taking a daylight-sync photograph with [4AUTO] displayed on the LCD panel, the flash may not discharge.

SLOW-SPEED-SYNC SHOOTING



III
ADVANCED OPERATIONS

Purpose

It is possible to balance the exposure of a foreground subject against a dimly-lit background by using the flash to properly expose the foreground subject and a slow-shutter-speed to expose the low light background.

How to set

With the Night-scene Program Mode set

1. Set the mode dial to [].
2. Set the lens aperture ring to [A].
3. The built-in flash pops up automatically.
4. Before shooting, confirm that the flash is fully charged.

- In this mode, the shutter speed automatically changes with ambient brightness. The shutter speed changes in the range from 1/100 sec. to 1 second
- When the flash does not pop-up in the step 3, push the flash pop-up button to activate the flash.

How to set

With the Metered Manual Mode set

1. Depress the flash pop-up button to activate the built-in flash.
2. Set the camera's exposure mode to the Metered Manual Mode.
3. Select an appropriate shutter speed (slower than 1/100 of second) and aperture combination for a correct exposure.
4. Before shooting, confirm that the flash is fully charged.

Note

- The slow-speed-sync can also be used with the Shutter-Priority AE Mode set. Confirm that the exposure warning (Blinking aperture setting) is not appearing in the viewfinder.
- In the slow-shutter-sync shooting, use of a tripod is recommended to prevent camera shake.

A number of dedicated accessories are available for this camera.

- **Cable Switch F**

A shutter release cord designed for use with the camera equipped with the release socket. See the Cable Switch F operating manual for more details.

- **Magnifier Fa**

A viewfinder accessory for magnifying the central area of the viewfinder.

- **AF500FTZ**

A TTL Auto Zoom flash with a built-in AF spotbeam and large guide number of 50 in meters (ISO 100). It features the slave sync flash function, multiple flash burst, contrast-control-sync flash, leading/trailing-curtain-sync flash mode.

- **AF330FTZ**

A TTL Auto Zoom flash with a built-in AF spotbeam and guide number of 33 in meters (ISO 100). It features the contrast-control sync flash, leading/trailing-curtain-sync flash mode.

- **AF220T**

A TTL Auto flash with a guide number of 22 in meters (ISO 100).

- **Macro Flash AF140C**

A TTL macro flash unit with the guide numbers 14 in meters (ISO 100).

- **AF Adapter 1.7X**

An adapter for autofocus photography using a non-autofocus lens with a maximum aperture of f/2.8 or larger.

- **Refconverter A**

Right angle finder which attaches to the grooves on both sides of the viewfinder. The viewfinder magnification is able to switch from 1X to 2X.

- **AA-Battery Pack Fa**

The battery pack which takes four AA batteries can attach at the bottom of the camera, instead of using the lithium batteries.

- **Data Back FG**

Allowing you to print one of the following modes on the film both standard format mode and panorama format mode.

Year / month / day, day / month / year, month / day / year, day / hour / minute, ----- (blank)

Notes on accessories

- "Auto Bellows A" cannot be used in combination with the double cable release. Use "Cable switch F" instead. When taking a vertical photograph, position the camera with the grip facing upward. In this case, however, the cable switch F cannot be used, so shooting in a vertical position is not recommended.
- When attaching the "ADAPTER K FOR 645 LENS" to the camera body, the camera shift lock screw of the lens may hit the camera body. To avoid this, change the position of the fixing screw.
- When the refconverter A is used, it may interfere with the camera when you open or close the back cover. Remove the refconverter A before opening or closing the back cover.

CAMERA CASE

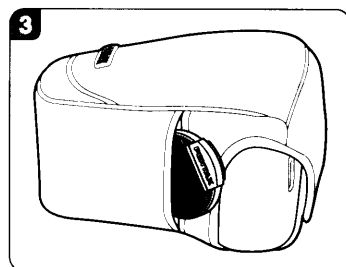
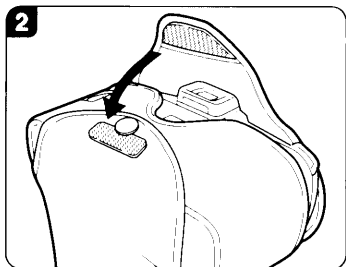
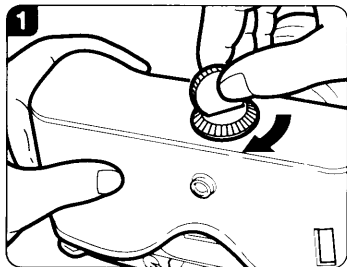

The soft case is available as an option and consists of a front and a back cover.

1. Open the front cover and place the camera body in the back cover.
2. Attach the front case.
- 3 There is a pocket on the front case so you can store the lens cap.

- Do not store the filter in the pocket. The filter could break if bumped.
- Choose one of the front cases in accordance with the table to the right.
- The back case is the same back case indicated with the Soft case S,M and L.

Front case comes in three sizes, S, M and L

Case	Applicable F, FA-lens
FKS	20mm, 24mm, 28mm, 35mm, 43mm limited, 50mm f/1.4, f/1.7, 77mm Limited, 135mm, Fish-Eye Zoom 17-28mm, Zoom 20-35mm, Zoom 28-70mm f/4, Zoom 28-80mm f/3.5-5.6, Zoom 35-80mm, Macro 50mm, Macro 100mm f/3.5, Soft 28mm, Soft 85mm
FKM	85mm f/1.4, Zoom 28-105mm, Zoom 28-200mm
FKL	Macro 100mm f/2.8, Zoom 70-200mm, Zoom 80-200mm f/4.7-5.6

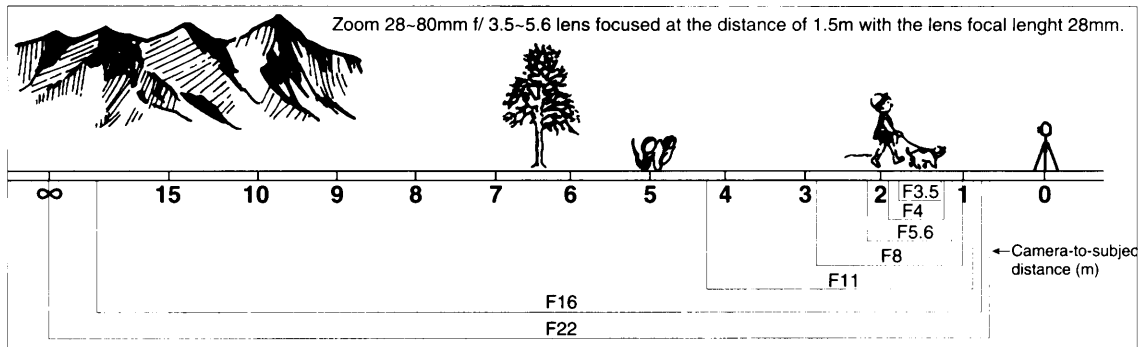







Depth of field refers to the range around the optimum focusing point of the subject in which the elements at different distances are in focus. The depth of field increases as the aperture is closed down, the focal length of the lens becomes shorter, or the subject is positioned farther away.

The Range Allowed for Focusing

The in-focus range varies depending on the aperture in use. Zoom lenses do not have a depth-of-field scale for mechanical considerations.

What appears troublesome may be easily remedied. Here are some problems that may occur and their remedies. Before contacting a Pentax service center, check the following items.

Symptoms	Causes	Remedies	Reference
The shutter does not release.	The main switch is [OFF].	Turn ON the main switch.	P. 16
	The low battery warning [] is blinking.	Replace the battery.	P. 12
	The battery is improperly installed.	Install the battery properly.	P. 12
	The mode dial is set at [ISO] or []]	Set the mode dial to another position.	P. 46
	Self-timer mode is being set.	Cancel the self-timer mode.	P.39
	The built-in flash is being charged.	Wait until the flash is fully charged.	P.34
Indicators do not appear on the LCD panel.	The main switch is [OFF].	Turn ON the main switch	P.16
	No battery has been installed.	Install the battery.	P.12
	The battery is improperly installed. The battery is dead.	Replace the battery.	P.12
	AF frame is not placed over the subject.	Move the camera until the AF frame [] covers the subject.	P.30
The camera does not focus.	The subject is too close.	Increase the camera-to-subject distance.	P.30
	The focus mode is set to [MF].	Set the focus mode switch to [AF].	P.28
	The subject is difficult to autofocus.	Focus manually by using the matte field	P.65

Symptoms	Causes	Remedies	Remedies
Memory lock and exposure compensation function do not operate.	The Auto picture mode or metered manual mode is being used.	Set the mode dial to another position.	P.24, 61
[] in the viewfinder blinks	The subject is too close or difficult to autofocus.	Focus manually by using the matte field.	P.65
The built-in flash does not charge.	The mode dial is being set to [].	Replace the battery.	P.12
The built-in flash does not activate when the flash-pop-up button is depressed.	The exposure mode is being set other than the Auto Picture Mode or Picture Mode.	Set the mode dial to another position.	P.26
The built-in flash does not pop-up automatically	The mode dial is set to other than Auto Picture Mode or Picture Mode.	Set the exposure mode to Auto Picture or Picture Mode.	P.25.46
The built-in flash does not discharge even if the flash is upped position.	When [] appears on the LCD panel, the built-in flash does not discharge because the flash light is not required.		P.25
The power zoom system does not function.	The camera does not have the power zoom function.		P.27

In rare cases, the camera may not operate correctly due to statistic electricity. This can be remedied by taking the batteries out and putting them back in again.

SPECIFICATIONS

- Type:** ————— TTL autofocus, auto-exposure 35mm SLR with built-in TTL auto flash (RTF)
- Format:** ————— 24x36mm (approx. 13x36 in panorama format)
- Usable Film:** ——— 35mm perforated cartridge film. DX-coded film with ISO 25-5000; non-DX coded films with ISO 6-6400
- Exposure Modes:** — Auto Picture Mode, Picture Mode (Green Operation Mode, Portrait Program Mode, Landscape Program Mode, Close-up Program, Action Program Mode, Night-scene Program Mode), Shutter-Priority AE Mode, Aperture-Priority AE Mode, Metered Manual Mode, Bulb Mode, TTL Flash Mode
- Shutter:** ————— Electronically controlled vertical-run focal-plane shutter, Electromagnetic release, Speed range:(1)Auto 1/2000-30 sec.(stepless),(2)Manual 1/2000-30 sec.(3)Bulb, Shutter lock by setting Main switch in OFF position.
- Lens Mount:** ——— Pentax K_{AF} bayonet mount (K-mount with AF coupler, lens information contacts)
- Compatible Lens:** — Pentax K_{AF}-, K_{AF}-, K_A-, and K-mount lenses are usable. Autofocus is possible using AF Adapter with K_A-mount lenses.
- Autofocus System:** — TTL phase-matching multi(3-point) autofocus system, AF operational brightness range: EV-1 to 18(at ISO 100 with f/1.4 lens), Focus lock available using shutter release button, Focus Mode: AF (predictive AF provided), Manual [MF]
- Power Zoom:** ——— Not available.
- Viewfinder:** ————— Pentamirror finder, Natural-Bright-Matte focusing screen, Field of view:92%, Magnification:0.7X (with 50mm f/1.4 lens at ∞), Diopter: -2 to +1m⁻¹, Panorama format frame
- Viewfinder Indication:** Focus Information: In-focus (Green lamp [●] is lit), front or back focus signals and unable-to-focus indicator (Green lamp blinks), Shutter speed indication, Aperture indication, Flash ready indication [⚡] is lit, Bar graph(exposure compensation),Over or Under exposure indication in Metered Manual Mode, exposure compensation indication, Green Operation Mode [●], Portrait Program Mode [👤], Landscape Program Mode [▲], Close-up Program Mode [📷], Action Program Mode [🏃], Night-scene Program Mode [🌃], [*] memory lock indicator
- External LCD panel Indication:** ————— Shutter speed, Aperture value, [⚡] = Built-in flash ready indication, [⚡] = blinking slowly flash recommended warning, [⚡] = blinks rapidly Inappropriate lens warning, [⦿] = Red-eye reduction flash mode, [AUTO] = Auto-popup flash function, Flash disable function [⦿], ISO indication, [0_ _] = Film status information, [⚡] = Battery exhaustion warning, Exposure counter, [■] = PCV signal indication, [📷] = Exposure compensation, Exposure compensation value, [⦿] = Self-timer, [📷] = Instant release with remote control unit, [📷] 3s = 3 sec. delay shutter release with remote control unit, [📷] = Consecutive shooting, [📷] = Multiple exposure

- Self-timer** ————— Electronically-controlled type with delay time of 12 sec. Start by depressing of shutter release button, Operation confirmation: By PCV beep tone. Cancelable after operation
- Mirror:** ————— Instant-return mirror with AF secondary mirror
- Film Loading:** — Film advances automatically to 1st frame after back cover is closed, Film information window is provided
- Film Wind & Rewind:** ————— Auto wind/rewind by built-in motor, Consecutive or Single advance mode, Approx.2 frames/sec.(consecutive mode), Auto rewinding starts at end of roll, Film rewind/completion of rewinding is displayed on the LCD panel, Mid-roll rewind button will rewind film in mid-roll
- Exposure Meter:** — TTL multi(6)-segment metering, Metering range from EV0 to EV21 at ISO100 with 50mm f/1.4 lens
- Exposure Compensation:** — ± 3EV in 0.5EV step increments
- Flash:** ————— Series-control, Auto-popup TTL Auto Flash (RTF), Guide number:11 (ISO100/m), Illumination angle covers 28mm lens angle of view, Flash-sync-shutter in the range from 1/100 sec. to a slower speed, Day-light-sync flash, Slow-shutter-sync flash, Contrast-control-sync flash (ISO range = 25 - 800), Automatic flash function, Red-eye reduction flash function
- Flash sync:** — Hot shoe with X-contact with couples with Pentax dedicated auto flashes, ISO range = 25-800, Red-eye reduction flash function
- Power Source:** — Two 3V lithium batteries (CR2 or equivalent)
- Battery Exhaustion Warning:** — Battery exhaustion symbol [] is lit (blinking when the shutter is locked; no indication on the right-hand edge of the viewfinder.)
- Dimension and Weight:** ————— 135.5mm(W)x92.0mm(H)x63.5mm(D) (5.3'x3.6'x2.5') 380g (13.4 oz) body only without batteries
- Date Model Dimension and weight:** ————— 135.5mm(W)x92.0mm(H)x63.5mm (5.3'x3.6'x2.5') 395g (13.9 oz)
- Supplied Accessories:** — Hot Shoe Cover FK, Release Socket Cap F, Camera Strap FK, Eye Cup FK, Finder Cap
- Back cover:** — Interchangeable for replacing with Data Back FG

OTHERS

SPECIFICATIONS ARE SUBJECT TO CHANGE AT ANY TIME WITHOUT NOTIFICATION OR ANY OBLIGATION ON THE PART OF THE MANUFACTURER.

PROGRAM LINE

Green Operation Mode

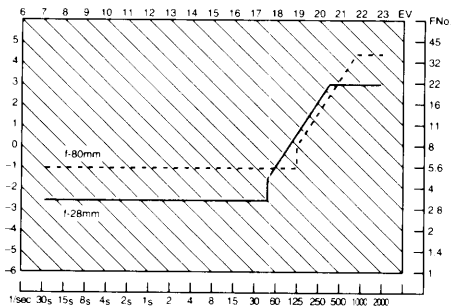

At ISO 100 with FA28 - 80mm f/3.5 - 5.6 lens

Portrait Program Mode

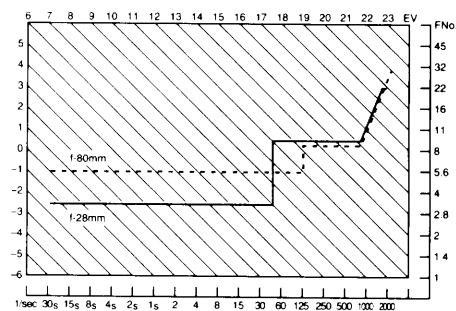

At ISO 100 with FA28 - 80mm f/3.5 - 5.6 lens

Landscape Program Mode

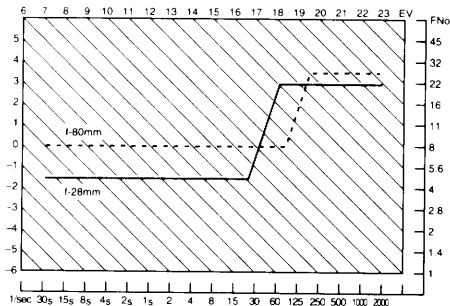

At ISO 100 with FA28 - 80mm f/3.5 - 5.6 lens

OTHERS

Close-up Program Mode

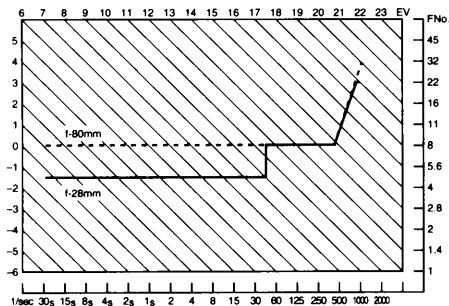

At ISO 100 with FA28 - 80mm f/3.5 - 5.6 lens

Action Program Mode

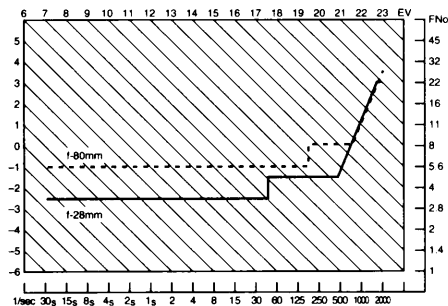

At ISO 100 with FA28 - 80mm f/3.5 - 5.6 lens

OTHERS

WARRANTY POLICY

All Pentax cameras purchased through authorized bona fide photographic distribution channels are guaranteed against defects of material or workmanship for a period of twelve months from date of purchase. Service will be rendered, and defective parts will be replaced without cost to you within that period, provided the equipment does not show evidence of impact, sand or liquid damage, mishandling, tampering, battery or chemical corrosion, operation contrary to operating instructions, or modification by an unauthorized repair shop. The manufacturer or its authorized representatives shall not be liable for any repair or alterations except those made with its written consent and shall not be liable for damages from delay or loss of use or from other indirect or consequential damages of any kind, whether caused by defective material or workmanship or otherwise; and it is expressly agreed that the liability of the manufacturer or its representatives under all guarantees or warranties, whether expressed or implied, is strictly limited to the replacement of parts as hereinbefore provided. No refunds will be made on repairs by non-authorized Pentax service facilities.



OTHERS

Procedure During 12-month Warranty Period.

Any Pentax which proves defective during the 12-month warranty period should be returned to the dealer from whom you purchased the equipment or to the manufacturer. If there is no representative of the manufacturer in your country, send the equipment to the manufacturer, with postage prepaid. In this case, it will take a considerable length of time before the equipment can be returned to you owing to the complicated customs procedures required. If the equipment is covered by warranty, repairs will be made and parts replaced free of charge, and the equipment will be returned to you upon completion of servicing. If the equipment is not covered by warranty, regular charges of the manufacturer or of its representatives will apply. Shipping charges are to be borne by the owner. If your Pentax was purchased outside of the country where you wish to have it serviced during the warranty period, regular handling and servicing fees may be charged by the manufacturer's representatives in that country. Notwithstanding this, your Pentax returned to the manufacturer will be serviced free of charge according to this procedure and warranty policy.

In any case, however, shipping charges and customs clearance fees to be borne by the sender. To prove the date of your purchase when required, please keep the receipt or bills covering the purchase of your equipment for at least a year. Before sending your equipment for servicing, please make sure that you are sending it to the manufacturer's authorized representatives or their approved repair shops, unless you are sending it directly to the manufacturer. Always obtain a quotation for the service charge, and only after you accept the quoted service charge, instruct the service station to proceed with the servicing.

The local warranty policies available from Pentax distributors in some countries can supersede this warranty policy. Therefore, we recommend that you review the warranty card supplied with your product at the time of purchase, or contact the PENTAX distributor in your country for more information and to receive a copy of the warranty policy.

STATEMENT OF FCC COMPLIANCE

This device complies with Part 15 of the FCC Rules. Operation is subject to the following two conditions: (1) This device may not cause harmful interference, and (2) this device must accept any interference received, including interference that may cause undesired operation. Changes or modifications not approved by the party responsible for compliance could void the user's authority to operate the equipment.

This equipment has been tested and found to comply with the limits for a Class B digital device, pursuant to part 15 of the FCC Rules. These limits are designed to provide reasonable protection against harmful interference in a residential installation. This equipment generates, uses and can radiate frequency energy and, if not installed and used in accordance with the instructions, may cause harmful interference to radio communications. However, there is no guarantee that interference will not occur in a particular installation. If this equipment does cause harmful interference to radio or television reception, which can be determined by turning the equipment off and on, the user is encouraged to try to correct the interference by one or more of the following measures:

- Reorient or relocate the receiving antenna.
- Increase the separation between the equipment and receiver.
- Consult the dealer or an experienced radio/TV technician for help.

This Class B digital apparatus meets all requirements of the Canadian Interference - Causing Equipment Regulations.



Asahi Optical Co., Ltd. 11-1 Nagata-cho 1-chome, Chiyoda-ku, Tokyo 100-0014, JAPAN (Internet://www.pentax.co.jp/)
Pentax Europe n.v. Weisveldlaan 3-5, 1930 Zaventem, BELGIUM (Internet://www.pentaxeuropa.com/)
Pentax GmbH. Julius-Vosseler-Strasse, 104, D-22527 Hamburg, GERMANY (Internet://www.pentax.de/)
Pentax U.K. Limited Pentax House, Heron Drive, Langley, Slough Berks SL3 8PN, U.K.
Pentax FRANCE S.A. 12/14, rue Jean Poulmarch, 95100 Argenteuil Cedex, FRANCE
Pentax Benelux B.V. (for Netherlands) Spinveld 25, 4815 HR Breda, NETHERLANDS
(for Belgium & Luxemburg) Weisveldlaan 3-5, 1930 Zaventem, BELGIUM
Pentax (Schweis) AG Industriestrasse 2, 8305 Dietlikon, SWITZERLAND
Pentax Scandinavia AB P.O. Box 650, 75127 Uppsala, SWEDEN
Pentax Corporation 35 Inverness Drive East, Englewood, Colorado 80112, U.S.A. (Internet://www.pentax.com/)
Pentax Canada Inc. 3131 Universal Drive, Mississauga, Ontario L4X 2E5, CANADA